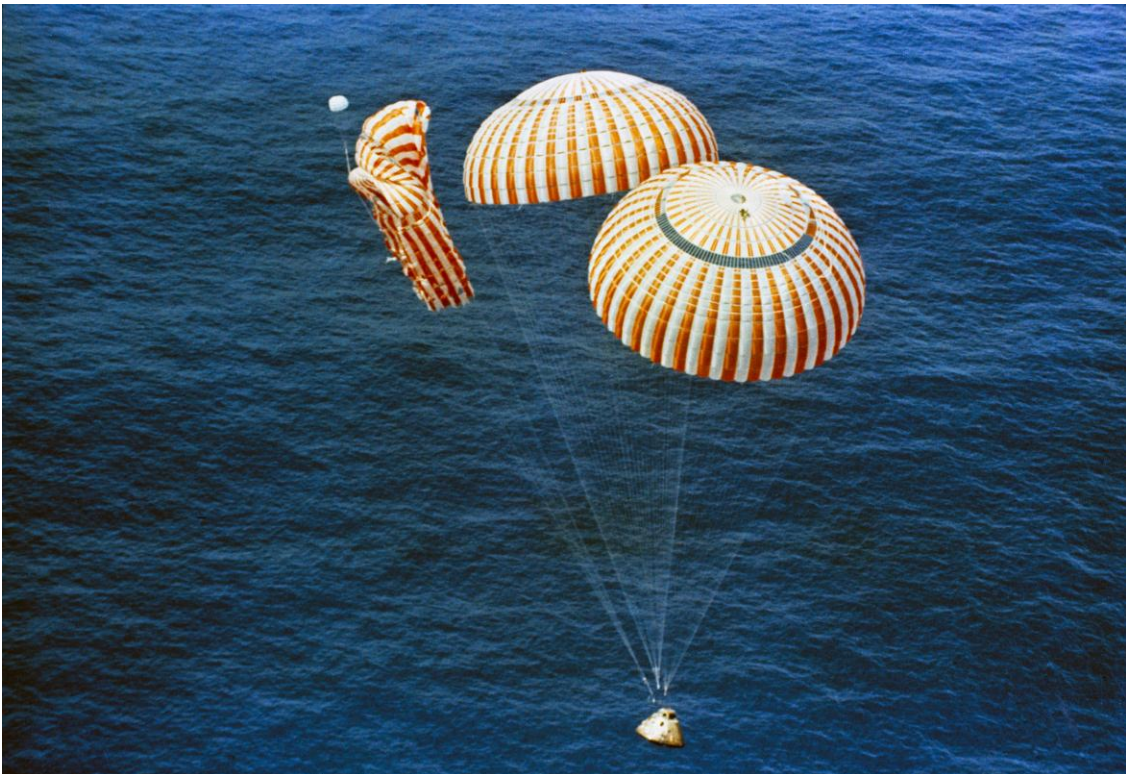


# REENTRY OF SPACE CRAFT TO EARTH ATMOSPHERE

*By Alexander Bolonkin*



**New York, 2012**

# *REENTRY OF SPACE CRAFT TO EARTH ATMOSPHERE*

**By Alexander Bolonkin**

C&R, abolonkin@juno.com

## **ABSTRACT**

Currently reentry of USA Space Shuttles and Command Module of Lunar Ships burns a great deal of fuel to reduce reentry speed because the temperatures are too high for atmospheric braking by conventional fiber parachutes. Recently high-temperature fiber and whiskers have been produced which could be employed in a new control rectangle parachute to create the negative lift force required. Though it is not large, a light parachute decreases Shuttle speed from 8 km/s (Shuttle) and 11 km/s (Apollo Command Module) up to 1 km/s and Space Ship heat flow by 3 - 4 times (not over the given temperature). The parachute surface is opened with backside so that it can emit the heat radiation efficiently to Earth-atmosphere. The temperature of parachute is about 600-1500° C. The carbon fiber is able to keep its functionality up to a temperature of 1500-2000° C. There is no conceivable problem to manufacture the parachute from carbon fiber. The proposed new method of braking may be applied to the old Space Ship as well as to newer spacecraft designs.

-----  
**Keywords:** *Atmospheric reentry, Space Shuttle, thermal protection of space craft, parachute braking.*

## **INTRODUCTION**

In 1969 author applied a new method of global optimization to the problem of atmospheric reentry of spaceships [1 p. 188]. The offered analysis presented an additional method to the well-known method of outer space to Earth-atmosphere reentry ("high-speed corridor"). In that approach, reentry is made in a low-speed corridor where total heat is less than conventional high-speed passage. At that time, in order to significantly decrease the speed of a spaceship, retro- and landing rocket engines which consumed a great deal of fuel were needed. With the new development by the textile industry of heat

resistant fiber, parachute brake system can now be used in a high-temperature environment [2]-[4].

### **Main idea, Description of the parachute innovations and control**

The greatest danger to spacecraft is the high temperatures generated upon reentry to Earth. The death of six astronauts in the Columbus catastrophe was the result of minor damage to the heat shield. Upon close examination, the danger of heat flow is only at altitudes of 50 – 60 km where the air has enough density so that space craft traveling at a high speed is met with air resistance which generates heat. It is not the ambient temperatures but the temperatures generated by air resistance which is a danger. At altitudes over 160 km the temperature of Earth atmosphere is more 1000°C, but because the air density is small there is no danger to space craft. In fact, a space ship can safely pass through space where space particles have temperature in millions degrees because their density is extremely small.

A space craft can avoid severe heating in reentry if it does not travel at high speed (lower than 2 -3 km/sec) when it is lower altitudes of 55 – 60 km. As such, the space craft speed may be decreased by back force of a rocket engine, but this method requires a great deal of fuel. Currently, space craft is designed with a blunt nose which by increasing air drag, decrease the craft's high speed but this generates high heat flow which means that space craft needs the protection by heavy ceramic shield which is vaporized upon reentry and largely requires replacement after every flight.

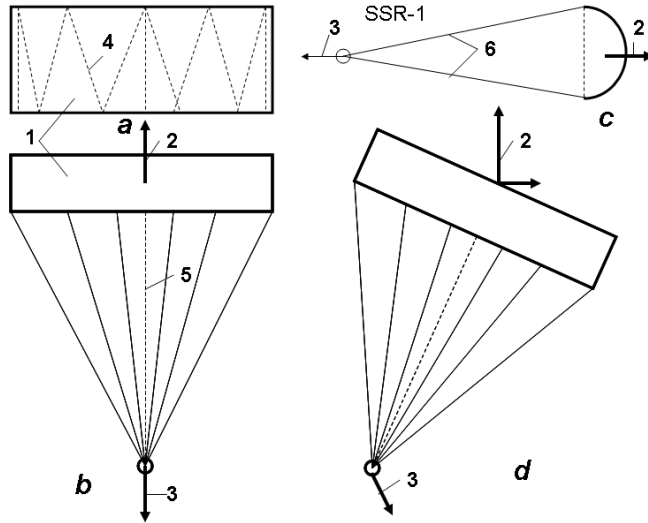
This paper proposes another method for braking the space craft in high altitude where the atmosphere is rarefied by a controlled hypersonic braked parachute for braking. The brake distance may be long. If the speed is significantly less than 8 km/s, the craft needs an additional lift force for supporting it. If the speed is radically more than 8 km/s, the centrifugal force is very large and the craft needs a significant NEGATIVE lift force for holding it into Earth atmosphere. That means the parachute must have a control. The proposed design for this rectangle control lift/drag parachute has the high ratio lift/drag (up  $\pm 4$ ) and allows it to change the minimum/maximum drag 1:10.

The suggested method has significantly advantages over the current method (ceramic heat plates):

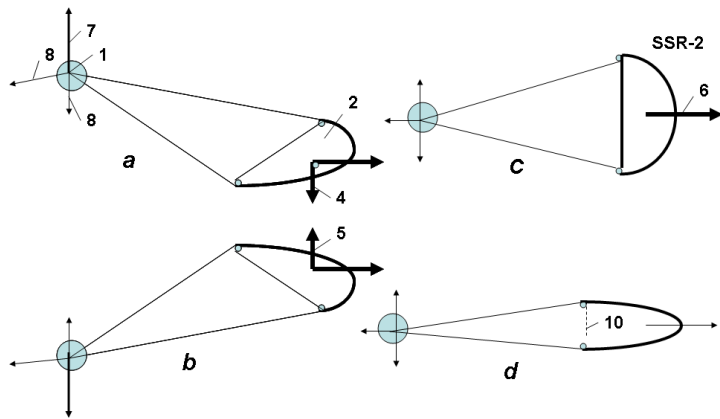
- 1) The braked system has less weight.
- 2) This system may be used also for landing on ground.
- 3) The system is not in need of repair after each landing.
- 4) System may be used many times.

The parachute design is shown in fig.1. Parachute has the rectangle form and special control which allows it to change the length of cords (strops) (fig.2) and size of parachute entrance. The change of the cord length permits creating the lift force, the change of the direction of a lift force up to a negative lift force (fig.2, a, b), and creating the side force

(fig.1, d). The cable control (fig.1, items 4-5) allows it to change the parachute aperture (fig.2 c, d) and the value of the parachute drag. The canopy and strops made from high temperature fiber, for example carbon filament. The parachute can have a rigid tin plate in forward edge.

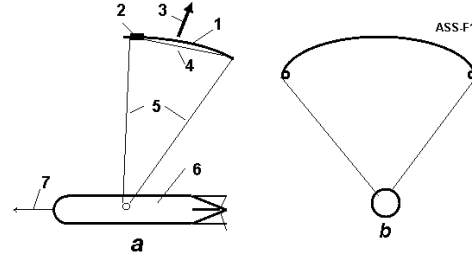


**Fig.1.** The proposed design of a control mechanism for the high temperature parachute for braking space craft in the Earth high atmosphere. *Notations:* **a** –forward view (from space craft), **b** – side view, **c** –side view, **d** – creating of side force. 1 – parachute, 2 – brake force, 3 - direction of moving, 4 – 5 control cable (by changing the enter section), 6 – strops (cord, slings).



**Fig. 2.** Control of air drag, the positive and negative lift force (relative of horizontal moving) by offered parachute. *Notations:* **a** – producing the negative (direction down) lift force, **b** - producing the positive lift force, **c** – full drag of parachute, **d** – part drag of parachute; 1 – space craft, 2 – parachute, 4 – negative lift force, 5 – positive lift force, 6 - air drag, 7 – centrifugal force, 8 – direction of moving, 9 – weight (gravity) of craft, 10 – control of parachute entrance.

Another method is shown in fig. 3 which employs a folding fabric wing with variable area. This apparatus has high ratio lift/drag and can fly in the high rarified atmosphere for a long time.



**Fig. 3.** The fabric lift-brake wing. *Notations:* **a** – side view, **b** – forward view; 1 – wing-parachute, 2 – rigid plate, 3 – lift-drag force, 4 – cable connecting the first-back edge, 5 – strops, 6 – space craft, 7 – direction of moving.

## THEORY

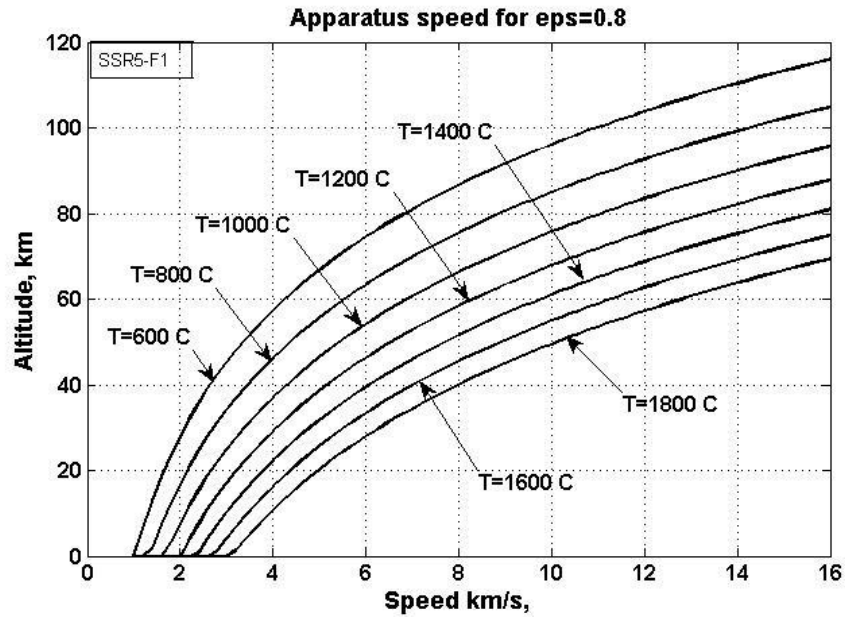
The curves of altitude via speed for the given temperature  $H = H(V, T)$  and the longitudinal and vertical overloads can be computed by equations:

$$Q = \varepsilon C_s \left[ \left( \frac{T_1}{100} \right)^4 - \left( \frac{T_2}{100} \right)^4 \right], \quad \rho = \rho_0 \left( \frac{Q}{K_q (V/V_0)^{3.15}} \right)^2,$$

$$H = 40000 + 6580(\ln 0.00292 - \ln \rho), \quad T = T_1 - 273, \quad (1)$$

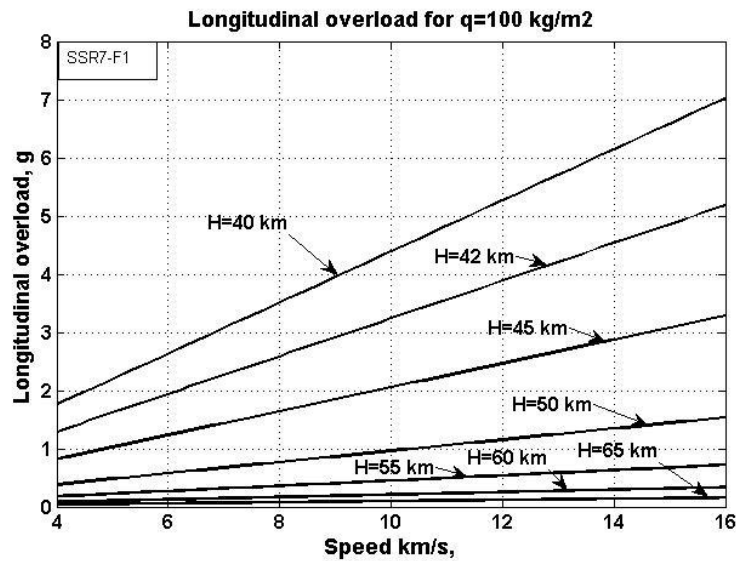
$$N_D = \frac{0.5 C_D \rho a V}{g q}, \quad N_L = K N_D - 1 + \frac{V^2}{g R},$$

where:  $g$  is Earth gravity,  $\text{m/s}^2$ ,  $g_0 = 9.81 \text{ m/s}^2$  is gravity at Earth surface;  $\rho$  is air density,  $\text{kg/m}^3$ ;  $Q$  is heat flow in  $1 \text{ m}^2/\text{s}$  of parachute,  $\text{J/s}\cdot\text{m}^2$ ;  $K_q \approx 1.3 \cdot 10^7$  is constant for parachute area  $1000 \text{ sq.m.}$ ;  $\rho_0 = 1.225 \text{ kg/m}^3$  is air density at sea level;  $V_0 \approx 7950 \text{ m/s}$  is circle orbit speed;  $T_1$  is temperature of parachute in stagnation point in Kelvin,  $^\circ\text{K}$ ;  $T$  is temperature of parachute in stagnation point in centigrade,  $^\circ\text{C}$ ;  $T_2$  is temperature of the standard atmosphere at a given altitude,  $^\circ\text{K}$ ,  $T_2 \approx 258$  at  $H = 40 \text{ km}$ ;  $C_D = 1$  is parachute drag coefficient;  $a \approx 295 \text{ m/s}$  is sound speed;  $N_D$  is longitudinal overload;  $N_L$  is vertical overload;  $q$  is specific load on parachute surface,  $\text{kg/sq.m.}$ ;  $K$  is ratio  $K = C_L / C_D$ ,  $\varepsilon$  is emissivity. Result of computation is presented in figs. 4 – 6. The limit altitude via speed for the given temperatures in the stagnation point is shown in fig. 4.



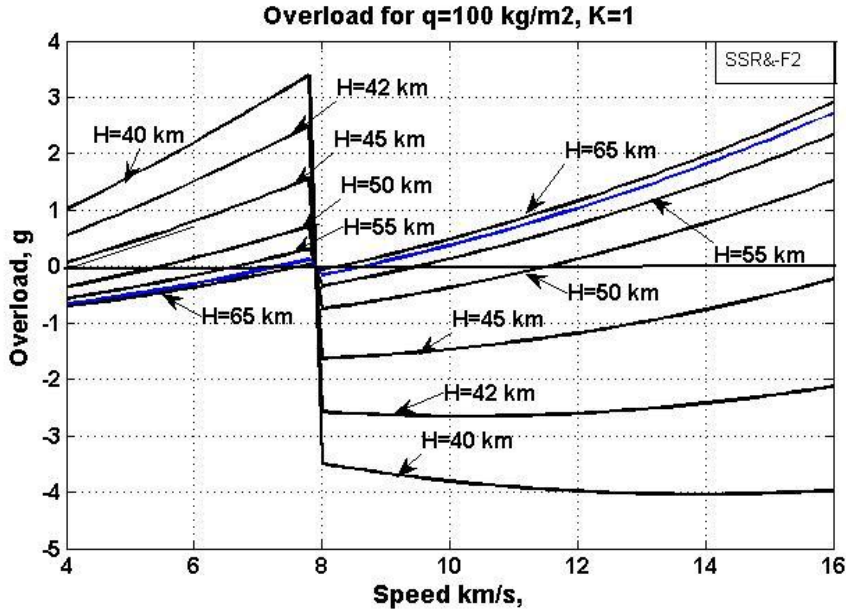
**Fig. 4.** Limit of altitude versus the speed for given stagnation temperature. Over this curve the temperature is less. Eps is emissivity. Safety temperature (less of given) is over appropriate curve.

As you see, we can reach a low temperature if the craft travels (losses speed) at high altitude. Although unimportant, the time of reentry is greater as the parachute lift force allows it to keep a needed altitude. The longitudinal overload versus speed for the different altitudes is shown in fig. 5.



**Fig. 5.** The longitudinal overload via speed in the different altitudes.  $q = 100 \text{ kg/sq.m.}$

As you see the overload is safe for manned space craft, but ideally suited for non-manned craft.



**Fig. 6.** Vertical overload via speed for the different altitudes, for ratio  $K = \text{Lift/drag} = \pm 1$  and the special parachute load  $q = 100 \text{ kg/m}^2$ .  $K = -1$  for  $V > 8 \text{ km/s}$ .

As you see the positive (for speed  $V < 8 \text{ km/s}$ ) and negative (for  $V > 8 \text{ km/s}$ ) vertical load is also not large.

The reentry trajectory of craft may be computed by equations:

$$\begin{aligned}
 \dot{r} &= \frac{R_0}{R} V \cos \theta, \\
 \dot{H} &= V \sin \theta, \\
 \dot{V} &= -\frac{D + D_p}{m} - g \sin \theta, \\
 \dot{\theta} &= \frac{L + L_p}{mV} - \frac{g}{V} \cos \theta + \frac{V \cos \theta}{R} + 2\omega_E \cos \varphi_E,
 \end{aligned} \tag{2}$$

where  $r$  is range of ship flight, m;  $R_0 = 6,378,000$  is radius of Earth, m;  $R$  is radius of ship flight from Earth's center, m;  $V$  is ship speed, m/s;  $H$  is ship altitude, m;  $\theta$  is trajectory angle, radians;  $D$  is ship drag, N;  $D_p$  is parachute drag, N;  $m$  is ship mass, kg;  $g$  is gravity at altitude  $H$ ,  $\text{m/s}^2$ ;  $L$  is ship lift force, N;  $L_p$  is parachute lift force, N;  $\omega_E$  is angle Earth speed;  $\varphi_E = 0$  is lesser angle between perpendicular to flight plate and Earth polar axis;  $t$  is flight time, sec. The magnitudes in equations (2) compute as in equations (1) or as below:

$$\begin{aligned}
g &= g_0 \left( \frac{R_0}{R_0 + H} \right)^2, \quad \rho = a_1 e^{(H-40000)/b}, \quad a_1 = 0.00292, \quad b = 6580, \\
Q &= \frac{5.5 \cdot 10^8}{R_n^{0.5}} \left( \frac{\rho}{\rho_{SL}} \right)^{0.5} \left( \frac{V}{V_{CO}} \right)^{3.15}, \quad R_n = \sqrt{\frac{S_p}{\pi}}, \\
T_1 &= 100 \left( \frac{Q}{\varepsilon C_s} + \left( \frac{T_2}{100} \right)^4 \right)^{1/4}, \quad T = T_1 - 273, \\
D_p &= 0.5 C_{DP} \rho a V S_p, \quad L_p \approx (1 \div 4) D_p, \quad L = 2 \alpha \rho a V S, \quad D = L / K, \\
\Delta V &\approx \frac{0.5 C_{DP} \rho a S_p L}{m},
\end{aligned} \tag{3}$$

where:  $g_0 = 9.81 \text{ m/s}^2$  is gravity at Earth surface;  $\rho$  is air density,  $\text{kg/m}^3$ ;  $Q$  is heat flow in  $1 \text{ m}^2/\text{s}$  of parachute,  $\text{J/s m}^2$ ;  $R_n$  (or  $R_p$ ) is parachute radius,  $\text{m}$ ;  $S_p$  is parachute area,  $\text{m}^2$ ;  $\rho_{SL} = 1.225 \text{ kg/m}^3$  is air density at sea level;  $V_{CO} = 7950 \text{ m/s}$  is circle orbit speed;  $T_1$  is temperature of parachute in stagnation point in Kelvin,  $^\circ\text{K}$ ;  $T$  is temperature of parachute in stagnation point in centigrade,  $^\circ\text{C}$ ;  $T_2$  is temperature of the standard atmosphere at given altitude,  $^\circ\text{K}$  ( $T_2 = 253 \text{ }^\circ\text{K}$  at  $H = 60 \text{ km}$ );  $D_p$  is parachute drag,  $\text{N}$ ;  $L_p$  is parachute lift force. That is control from 0 to 4  $D_p$ ,  $\text{N}$ ;  $D$  is ship drag,  $\text{N}$ ;  $L$  is ship lift force of craft,  $\text{N}$ ;  $C_{DP} = 1$  is parachute drag coefficient;  $a = 295 \text{ m/s}$  is average sound speed at high altitude;  $\alpha = 40^\circ = 0.7 \text{ rad}$  is craft attack angle.  $C_s = 5.67 \text{ W}/(\text{m}^2\text{K}^4)$  is coefficient radiation of black body;  $\varepsilon$  is parachute coefficient of a black ( $\varepsilon \approx 0.03 \div 0.99$ ),  $\Delta V$  is loss of speed in atmosphere on distance  $L$ .

The control is computed as follows: if  $T_1$  is more the given safety temperature than the lift force  $L_p = \text{maximum} = K D_p$ . If  $T_1$  is less the given safety temperature than the lift force  $L_p = \text{negative minimum} = - K D_p$ . When the speed is less the sound speed, the control parachute is also used for deliver in given point.

The proposed parachute area may be found by equations in lending study at sea level:

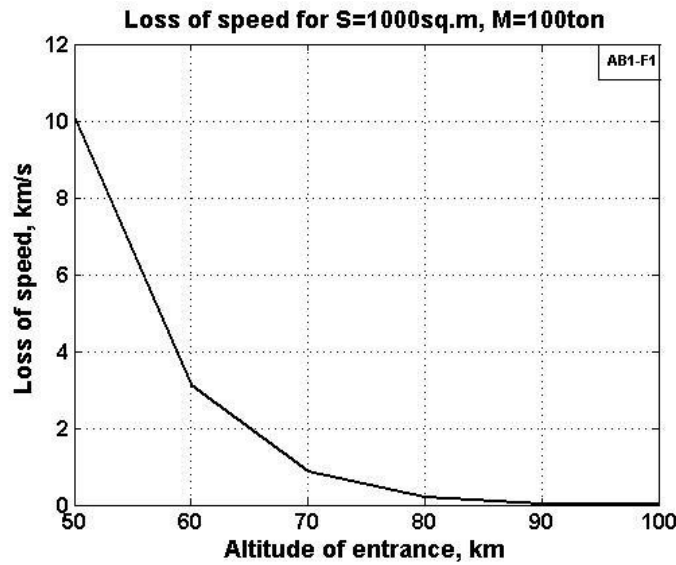
$$L_p = C_L \frac{\rho V^2}{2} S_p, \quad D_p = C_D \frac{\rho V^2}{2} S_p, \quad K = \frac{C_L}{C_D}, \quad V_v = \frac{V}{K}, \quad V_v \leq V, \tag{4}$$

where  $C_L$  is lift coefficient of parachute,  $C_L \approx 2 \div 3$ ;  $C_D$  is drag coefficient of parachute,  $C_D \approx 0.5 \div 1.2$ ;  $\rho = 1.225 \text{ kg/m}^3$  is air density;  $V$  is speed system,  $\text{m/s}$ ;  $S_p$  is parachute area,  $\text{m}^2$ ;  $K$  is ratio  $C_L/C_D$ ;  $V_v$  is vertical speed,  $\text{m/s}$ .

*For Example.* Let us take the mass of system (craft + parachute)  $100 \text{ tons} = 10^6 \text{ N}$ ,  $C_L = 2.5$ , safety  $V_v = 20 \text{ m/s}$ ,  $K = 4$ ,  $V = 80 \text{ m/s}$ . From equation (4) we receive the parachute area is  $S_p = 100 \text{ m}^2$ . The control rectangle parachute is  $5.8 \times 17.3 \text{ m}$ .

Fig. 7 presents the loss of speed via altitude on distance  $L = 6378 \text{ km}$  (radius of the Earth) for mass of a system  $100 \text{ ton}$  and parachute area  $1000 \text{ m}^2$ ,  $q = 100 \text{ kg/sq.m}$ .





**Fig.7.** Loss of speed via altitude for distance  $L = 6378$  km (radius of the Earth) for mass of system 100 ton and parachute area  $1000 \text{ m}^2$ ,  $q = 100 \text{ kg/sq.m.}$ .

For altitude of 80 km and distance of  $L = 6378$  km, the loss is about 150 m/s. The parachute can keep this altitude by lift force. In this case the system losses about 2 km/s during two revolutions around Earth. This allows decreasing the safety altitude up 70 km and increase the speed loss up 1 km on distance  $L$ . Control parachute allows a lift force (up and down) to decrease speed and to lend the system in need point of Earth surface.

#### **Notes about current reenter craft.**

##### **Orbital Ship Shuttle**

The main data of reentry of the Shuttle are: Empty weight is 78 tons; Full weight 104 tons; payload to LEO: 53,600 lb (24,310 kg), payload to GTO: 8,390 lb (3,806 kg); operational altitude 100 to 520 nmi (190 to 960 km; 120 to 600 mi); speed: 7,743 m/s (27,870 km/h; 17,320 mph).

The orbiter's maximum glide ratio/lift-to-drag ratio varies considerably with speed, ranging from 1:1 at hypersonic speeds, 2:1 at supersonic speeds and reaching 4.5:1 at subsonic speeds during approach and landing. In the lower atmosphere, the orbiter flies much like a conventional glider, except for a much higher descent rate, over 50 m/s (180 km/h; 110 mph) (9800 fpm). At approximately Mach 3, two air data probes, located on the left and right sides of the orbiter's forward lower fuselage, are deployed to sense air pressure related to the vehicle's movement in the atmosphere.

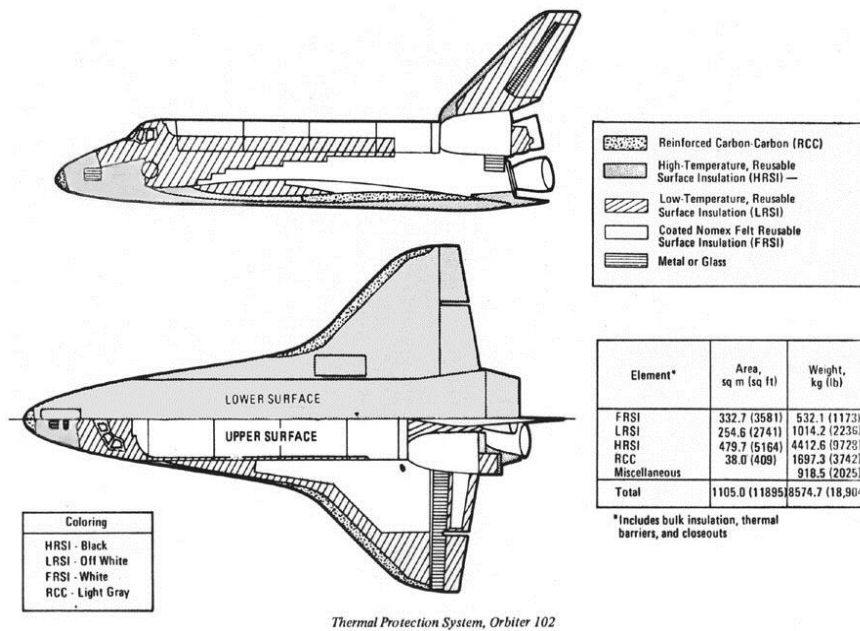
When the approach and landing phase begins, the orbiter is at a 3,000 m (9,800 ft) altitude, 12 km (7.5 mi) from the runway. The pilots apply aerodynamic braking to help slow down the vehicle. The orbiter's speed is reduced from 682 to **346 km/h** (424 to 215 mph), approximately, at touch-down (compared to 260 km/h (160 mph) for a jet airliner). The landing gear is deployed when the Orbiter is flying at 430 km/h (270 mph). To assist

the speed brakes, a 12 m (39 ft) drag chute is deployed either after main gear or nose gear touchdown (depending on selected chute deploy mode) at about 343 km/h (213 mph). The chute is jettisoned once the orbiter slows to 110 km/h (68.4 mph) (fig. 8).



**Fig. 8 .** Endeavour deploys drag chute after touch-down the Shuttle.(Credit NASA)

The conventional system for protection of space craft is shown in fig. 9.



**Fig. 9.** Space Shuttle Thermal Protection System Constituent Materials.

### Computation with conventional *brake* chute.

The computation of the reentry orbital space ship Shuttle with only a *brake* chute is presented in [2]-[3]. The control is following: if  $d\theta/dt > 0$  the all lift force  $L = L_p = 0$ .

When the Shuttle reaches the low speed the parachute area can be decreased or parachute can be detached. That case is not computed. Used control is not optimal.

The results of integration are presented in [3]. Used data: parachute area are  $S_p = 1000, 2000, 4000 \text{ m}^2$  ( $R_p = 17.8, 25.2, 35.7 \text{ m}$ );  $m = 104,000 \text{ kg}$ . The dash line is data of the Space Shuttle without a parachute. The parachute significantly decreases the shuttle speed from 8000 m/s to 350 - 2900 m/s after 550 sec of reentry flight (fig. 5 in [3]). Practically, the Space Shuttle overpasses the heat barrier (maximum of heat flow) near 200 sec into its reentry (see fig. 8 [3]). The heat flow depends on the power 3.15 from speed (see the second equation in (3)) and the speed strongly influences the heat flow. For example, the decreasing of speed in two times decreases the heat flows in 8.9 times!

At an altitude of 41 - 44 km the ship has speed 350 - 2900 m/s which is acceptable for high speed vehicle in short time of reentry (fig. 4).

The maximum temperature in a stagnation point of the parachute is 1000 - 1300° C (fig. 7 [3]). The parachute can be made from carbon fiber that can keep the temperature 1500 - 2000° C (carbon melting temperature is over 3000° C). At present a carbon fiber composite matters uses by Shuttle for leader edges of Shuttle where temperature reaches 1550° C.

Fig. 8 [3] shows the heat flow through 1 m<sup>2</sup>/s of Shuttle without or with a parachute. That is about 1.4 - 2.2 times less than without parachute. It means the future Space Shuttles can have a different system of heat protection and a modern design can be made lighter and cheaper.

#### **ESTIMATION PARACHUTE SYSTEM**

The weight of the parachute system in comparison with current heat protection is the key for this innovative method. Industry has produced many metal and mineral fibers and whiskers having very high tensile stress at high temperatures. To estimate the mass of parachute system, assume the carbon fiber used for this parachute has the maximum tensile stress  $\sigma = 565 \text{ kg/mm}^2$  ( $\sigma = 5.65 \times 10^9 \text{ N/m}^2$ ) at temperature  $T = 1500 - 2000^\circ \text{ C}$ . With a safety margin 2.3 - 3,  $\sigma = 150 \text{ kg/mm}^2$  for canopy and  $\sigma = 200 \text{ kg/mm}^2$  for cord. The fiber density is taken  $\gamma = 3000 \text{ kg/m}^3$ . The results of this computation are presented in Table 1.

Currently, the mass of the heat protection shield of the Shuttle is 9575 kg. By decreasing the heat flow by 2 - 3 times, the heat shield can be reduced proportionally saving 4 - 6 tons of Shuttle mass.

At the present time, changing of hundreds of hull protection tiles after every flight takes two weeks and is very costly to do. The new method requires only a few tile replacements (maximum temperature is less) or allows using a protective cooling method. The Command Module of spacecraft "Apollo" had a heat protection of approximately 1/2 of the total take-off/touchdown weight. The gain to be had from a new method reentering may be significantly more.

Table 1. **Parachute data**

Parachute area $S_p = S_m, m^2$	1000	2000	4000
Reference parachute radius $R_p, m$	17.8	25.2	35.7
Max. parachute pressure $P_p, N/m^2$	1250	2000	6000
Parachute surface $S_{pc} = 2\pi R_p^2, m^2$	2000	4000	8000
Parachute thickness $\delta = P_p R_p / 2\sigma, mm$	0.0074	0.0076	0.0072
Mass of canopy $M_c = S_{pc} \delta \gamma, kg$	45	90	171
Mass of cord, kg	66	132	258
Total mass, kg	111	226	429
Max. brake force, kN	1250	1800	2400
Add. Max. overload, g	1.25	1.8	2.4

## APOLLO COMMAND MODULE

### Earth Landing System Of Lunar Command Module.

The components of the ELS are housed around the forward docking tunnel. The forward compartment is separated from the central by a bulkhead and is divided into four 90-degree wedges. The ELS consists of three main parachutes, three pilot parachutes, two drogue parachute motors, three upright bags, a sea recovery cable, a dye marker, and a swimmer umbilical.

The Command Module's center of mass is offset a foot or so from the center of pressure (along the symmetry axis). This provides a rotational moment during reentry, angling the capsule and providing some lift (a lift to drag ratio of about 0.368). The capsule is then steered by rotating the capsule using thrusters; when no steering is required, the capsule is spun slowly, and the lift effects cancelled out. This system greatly reduces the  $g$ -force experienced by the astronauts, permits a reasonable amount of directional control and allows the capsule's splashdown point to be targeted within a few miles.

At 24,000 feet (7.3 km) the forward heat shield is jettisoned using four pressurized-gas compression springs. The drogue parachutes are then deployed, slowing the spacecraft to 125 miles per hour (201 km/h). At 10,700 feet (3.3 km) the drogues are jettisoned and the pilot parachutes, which pulls out the mains, are deployed. These slow the CM to 22 miles per hour (35 km/h) for splashdown. The portion of the capsule which first contacts the water surface is built with crushable ribs to further mitigate the force of impact. The Apollo Command Module could safely parachute to an ocean landing with at least two parachutes (as occurred on Apollo 15), the third parachute being a safety precaution.

Data of Apollo Command Module:

- Structure mass: 3,450 lb (1,560 kg)
- Heat shield mass: 1,870 lb (850 kg)
- RCS propellants: UDMH/N<sub>2</sub>O<sub>4</sub>

- RCS propellant mass: 270 lb (120 kg)
- Parachutes: two 16 feet (4.9 m) conical ribbon drogue parachutes; three 7.2 feet (2.2 m) ringshot pilot parachutes; three 83.5 feet (25.5 m) ringsail main parachutes



**Fig.10. Apollo Command Module.**

The method proposed in this paper (with control lift/drag force) can considerably decrease the required mass of the heat protection system. The Command Module of spacecraft "Apollo" has a heat protection of approximately 1/2 of the total take-off/touchdown weight. The gain to be had from a new method reentering may be significantly more.

## CONCLUSION

The widespread production of high temperature fibers and whiskers allows us to design high-temperature tolerant control lift/drag parachutes, which may be used by space craft of all types for braking in a rarified planet atmosphere. The parachute has open backside surface that rapidly emits the heat radiation to outer space thereby quickly decreasing the parachute temperature. The proposed new method significantly decreases the maximum temperature and heat flow to main space craft. That decreases the heat protection mass and increases the useful load of the spacecraft. The method may be also used during an emergency reentering when spaceship heat protection is damaged (as in horrific instance of the Space Shuttle "Columbia").

## Acknowledgement

The author wishes to acknowledge Professor Shmuel Neumann for correcting the English and offering useful advices and suggestions.

## REFERENCES

(Reader can find part of these articles in WEBS: <http://Bolonkin.narod.ru/p65.htm>, <http://arxiv.org>, search: Bolonkin, and in the book "*Non-Rocket Space Launch and Flight*", Elsevier, London, 2006, 488 pgs.)

- [1] Bolonkin A.A., *New Methods of Optimization and their Application*, Moscow High Technical University named Bauman, 1972, 220 ps, (in Russian).
- [2] Bolonkin A.A., A New method of Atmospheric Re-Entry for Space Ships, presented as paper AIAA-2006-6985 to 11<sup>th</sup> AIAA/ISSMO Multidisciplinary Analysis and Optimization Conference, 6-8 Sept. 2006, Virginia, USA.  
<http://aiaa.org> search "Bolonkin".
- [3] Bolonkin A.A., A New method of Atmospheric Re-Entry for Space Ships, Chapter 8 pp.153-160 in book Bolonkin A.A., *New Concepts, Ideas and Innovations in Aerospace, Technology and Human Sciences*, NOVA, NY, USA, 2006. ISBN-13: 978-1-60021-787-6, ISBN-10: 1-60021-787-7.  
<http://www.scribd.com/doc/24057071> ,  
<http://www.archive.org/details/NewConceptsIfeasAndInnovationsInAerospaceTechnologyAndHumanSciences>
- [4] Bolonkin A.A., *Non-Rocket Space Launch and Flight*, Elsevier, 2006, 488 ps.  
<http://www.archive.org/details/Non-rocketSpaceLaunchAndFlight> ,  
<http://www.scribd.com/doc/24056182>
- [5] Regan F.J., Anandakrishnan S.M., *Dynamics of Atmospheric Re-Entry*, AIAA, 1993.

October 2012