

Majorana and Sterile Neutrino solutions in the Quantum-FFF model.

Leo Vuyk,
Architect,
Rotterdam, the Netherlands.
LeoVuyk@Gmail.com

Abstract,

In particle physics it is an interesting challenge to postulate that the FORM and structure of elementary particles is the origin of different FUNCTIONS of these particles.

In my former paper “**3-Dimensional String based alternative particle model,**”

I presented a possible solution based on complex 3-D ring shaped particles.

I will give it the name: Quantum- FFF Theory. (Function Follows Form Theory).

The 3-D ring itself is postulated to represent the “Virgin Mother” of all other particles and is coined non-SM Higgs particle, supplied with the 3-hinges coded (OOO).

This paper presents the possible consequences of such a 3-D string particle system for MAJORANA particles and so called STERILE NEUTRINOS.

It seems to be a surprise that in the Q-FFF model there is a possibility for 4x different shaped Sterile Neutrinos and one symmetrical and two anti-symmetrical Majorana solutions.

At the same time I present some detailed features of how some Q-FFF particles can click-on to form micro black hole nuclei for Ball lightning or other anomalous effects happening inside particle accelerators.

Introduction,

It is assumed that the vacuum is seeded with awesome numbers of “new” massless Higgs vacuum particles. All vacuum particles seem to oscillate inside a chiral vacuum lattice system (reference: 16). this system seems to be able to transfer all photonic energy in wave form, but magically popping up real particles at collision sites with Fermions (wave particle duality). (Ref. 11)

This is reason to assume that Higgs particles are the origin and bearer of all energy and Matter in the universe.

If by a local energy excess, two oscillating Higgs particles collide head-on with enough excess of energy, it is assumed that at first an electron and positron emerges by the transformation or remodelling of these two Higgs particles.

Due to the propeller shape of the Fermions, they start to spin automatically by the constant collision and scattering process with the Higgs vacuum, remodelling and changing Higgs particles continuously into different forms of Photon/Gluons as a result.

This scattering system is supposed to be the origin of all radiation and energy in the universe including so called double LeSage gravity. (ref. 10)

It is also proposed, that at the globular horizon of black holes, Higgs particles are constantly producing numerous twins of electrons and positrons, due to spacetime (vacuum lattice) deformation. (Ref. 6)

However it is postulated the new Quantum FFF model allows electrons and positrons to form COMPOUND QUARKS by the new 3-D String particle paradigm (figure 3,4-5) .

At the same time, the complex double spin of fermions (figure 8) seems to be the origin of all material MOTION.

Recent publications reported the existence of so called Majorana (Ref. 19)particles and Sterile Neutrinos. (Ref. 20)

If we look in more detail to the possible transformations and rotations of the New Higgs particle (figure 5) it is clear that there is still room for such particles, as presented in yellow colour in the figure (figure 1)

Alternative standard particle model

All SINGLE (non-compound) elementary particles suggested by Quantum FFF Theory. OLO, ORO have "click-on potential" to form compound quark particles with only 5 different shaped Gluons/Photons. In yellow colour: Quantum-FFF suggestions for NEW PHYSICS particles. The Majoranas: (OUO+ mirroring Majoranas RUR+ LUL) and 4x extra neutrinos (RLU+ RRU+ LLU and LRU) (author:Leo Vuyk)

Explanation of the codes:

- U= Up rotation (180 degrees)
- O= Unchanged circle.
- L= Left rotation (90 degrees)
- R= Right rotation (90 degrees)

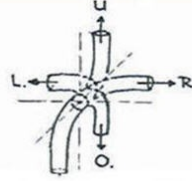

Summary with oscillation routes : (↔) or the definite Graviton decay route (→).

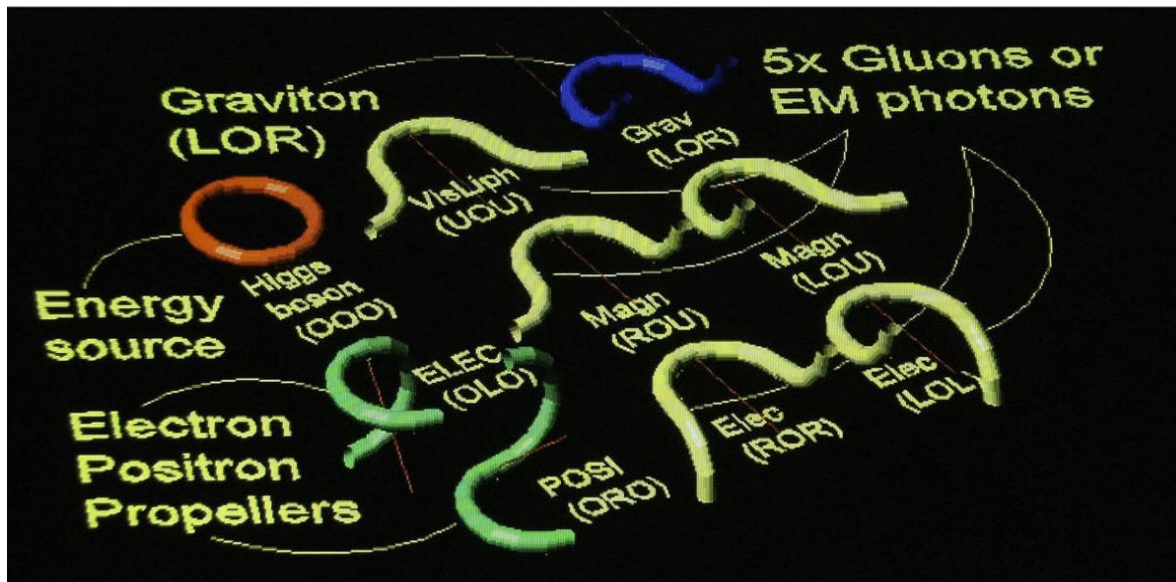
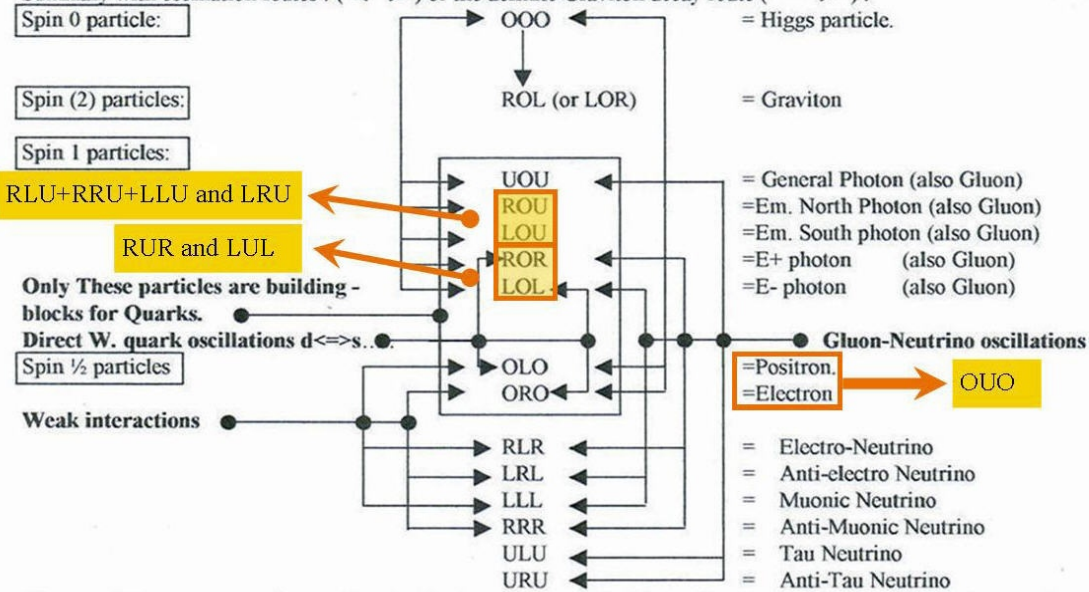

Figure 1, 3D image of Basic Singular Particles;

ONE Higgs boson (OOO), TWO basic single mirror symmetrical Fermions: the Electron and Positron (OLO and ORO), ONE Graviton (LOR), TWO sets of mirror symmetrical monopole Gluons/Photons (ROU-LOU, ROR-LOL) One symmetrical Gluon Photon (UOU).

For Majoranas (see upper image) one symmetrical (OUO) and two anti symmetrical (RUR+LUL).

For 4x Sterile Neutrinos: (RLU+ RRU+ LLU and LRU)

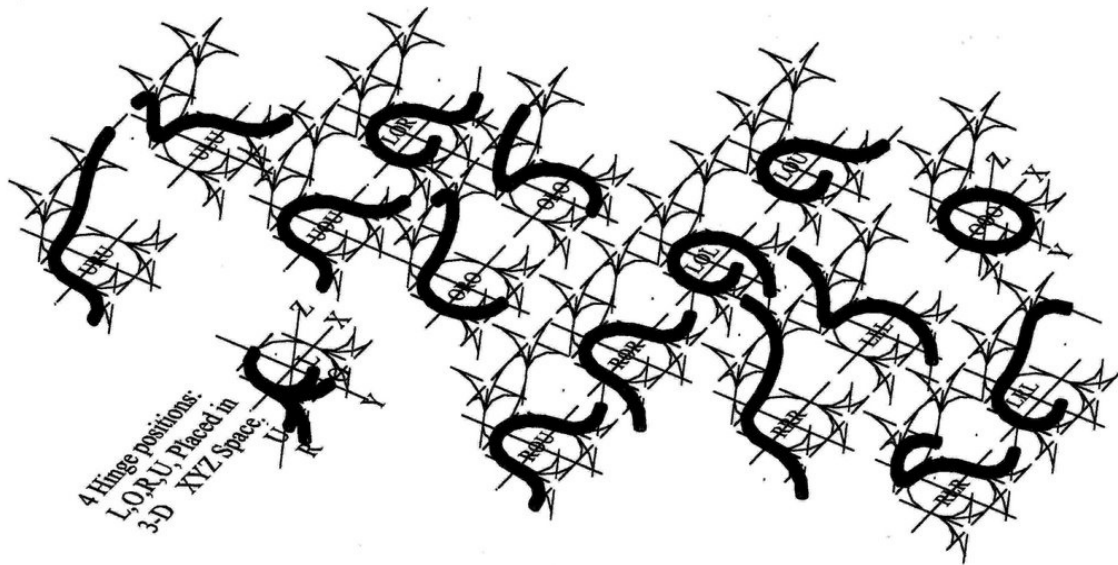

Figure 2, 3D image of Singular particles including 3 sets of mirror symmetrical Neutrinos: RLR-LRL, RRR-LLL, URU-ULU, bur without the Majoranas and Sterile Neutrinos.



Figure 3, 3D image of the Leptons: Electron, Positron, (singular) Muons and Tau particles (Compound particles).



Figure 4, 3D-Image of all 36 Quarks: UP-DOWN-STRANGE-CHARM-BOTTOM-TOP.

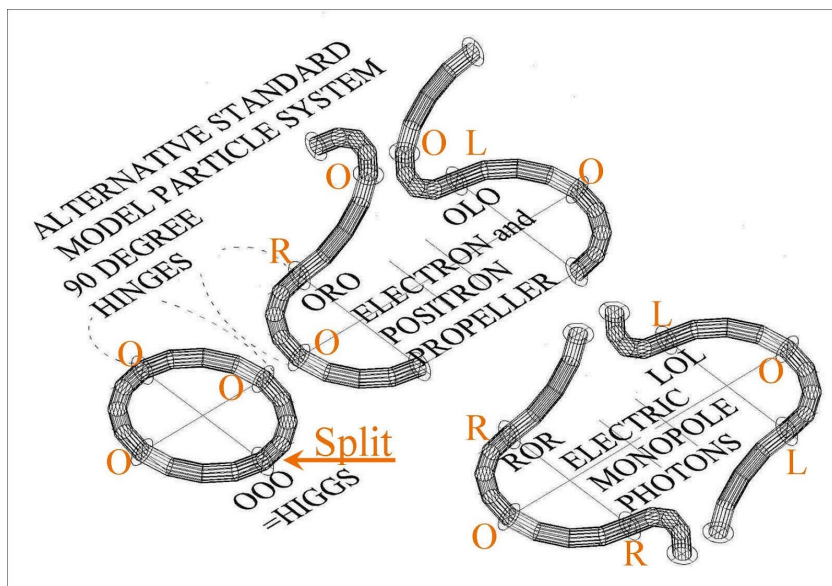

Figure 5.

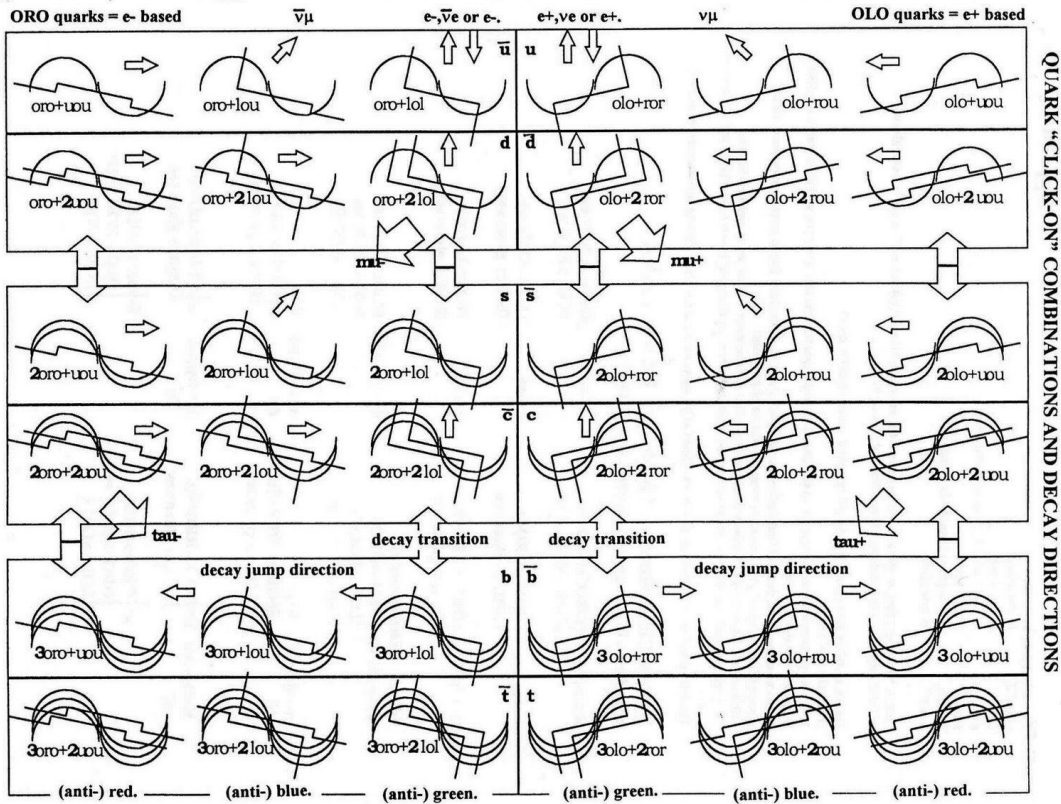

Figure 6, Simplified 2D image of Leptons and Quarks including indications for Decay routes indicated by arrows.

The Weak force, how change a d-quark (ORO+LLL+LRL) into an u-quark (OLO+ROR) in the case of Neutron-- Proton decay.

semi-leptonic processes

$$n \rightarrow p + e^- + \bar{\nu}_e$$

$$ddu \rightarrow duu + e^- + \bar{\nu}_e$$

The principle interaction is :

$$d \rightarrow u + e^- + \bar{\nu}_e$$

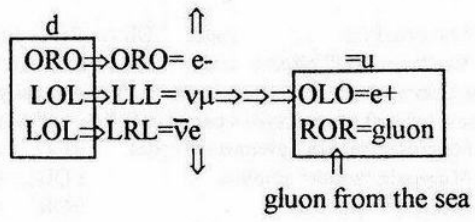

Figure 7, The WEAK force in action by a complex exchange of particles and without a clear sign of the Weak particle. Conclusion there is no need for a massive Weak particle in this system. The massless Higgs particle, seems to do the job properly by transformation of two compound Gluon particles (LOL) attached to the electron (ORO): (LOL into LLL) and (LOL into LRL) . In succession, the (LLL) particle is changed into (OLO) a Positron, able to combine with a free Gluon (ROR) out of the SEA of Gluon plasma.

THE DECAY OF QUARKS AND LEPTONS

According to my model: elementary particles have a **sub-quantum structure**, caused by the postulate that a kind of Higgs particle is the **basic elementary particle**. (see the relation with the model page: 4)

Two Higgs particles can change form by collision into an electron and positron pair.(ORO+OLO)

Each Higgs particle can change form by collision with a quark or lepton into one of the

6 different possible types of photons:

- 1: **The graviton** code: LOR (or ROL) can not "click-on" to e+ or e- particles to form quarks.
- 2: **The "general" photon** code UOU. can "click-on" to e+ or e- particles, to form quarks for all "red, anti-red" (the colors are my own choice) quarks. The general photon has no quark confinement function, so is not a "real" gluon.
- The 4 (gluon) photon types can also "click-on" to e+ or e- they are:**
- 3: **Magnetic "north" photon** (in code) ROU. combining for all "positive/blue, anti-blue" quarks.
- 4: **Magnetic "south" photon** LOU. combining for all "negative/blue, anti-blue" quarks
- 5: **Electric + photon** ROR. combining for all "positive/green, anti-green" quarks.
- 6: **Electric - photon** LOL. combining for all "negative/green, anti-green" quarks.

Quarks are "click-on" combinations of e- and e+s with 5 different types of photons: 4 gluon types and 1 general type. (so: quarks are not elementary)

Together with 1,2 or 3 **electrons**, 3 photon types can "click on" and combine into different **negative charged quarks**.

The **electron**: ORO can combine with LOL, LOU (gluons) and UOU (general photon)

Together with 1,2 or 3 **positrons**, 3 photon types can "click on" and combine into different **positive charged quarks**.

The **positron**: OLO can combine with ROR, ROU (gluons) and UOU (general photon)

Higgs boson (in code) OOO

The H-bosons is responsible for:

A: all photon/gluon production, as continuous collision product with all masscarrying particles.

(OOO+lepton/quark= photon/gluon+lepton/quark

B: spontaneous pair production (OOO+OOO=ORO+ OLO (e- and e+)),

Z	=ORO+OLO	Z-boson (electron + positron can "click" together, without annihilating each other)
Wo, W+ and W-		don't exist as particles.
e-	=ORO	electron.
e+	=OLO	positron.
ve	=RLR	electr. Neutrino.
$\bar{\nu}_e$	=LRL	anti-electr. Neutrino.
ν_μ	=LLL	muonic neutrino.
$\bar{\nu}_\mu$	=RRR	anti- muonic neutrino.
ν_τ	=ULU	tau neutrino
$\bar{\nu}_\tau$	=URU	anti- tau neutrino

For quark click-on combinations: see page 25 (o-p-r).

Quark "up-grading" due to subjoining of extra ORO's (or OLO's) (energy addition)

and extra gluons, joining from the "sea" of gluons (energy addition)

$e^- \rightarrow \bar{u} \rightarrow d \rightarrow s \rightarrow \bar{c} \rightarrow b \rightarrow \bar{t}$
 \rightarrow ORO \rightarrow 1 ORO \rightarrow 1 ORO \rightarrow 2 ORO \rightarrow 2 ORO \rightarrow 3 ORO \rightarrow 3 ORO.
 1 gluon \rightarrow 2 gluon \rightarrow 1 gluon \rightarrow 2 gluon \rightarrow 1 gluon \rightarrow 2 gluon.

$e^+ \rightarrow u \rightarrow \bar{d} \rightarrow \bar{s} \rightarrow c \rightarrow \bar{b} \rightarrow t$
 \rightarrow OLO \rightarrow 1 OLO \rightarrow 1 OLO \rightarrow 2 OLO \rightarrow 2 OLO \rightarrow 3 OLO \rightarrow 3 OLO.
 1 gluon \rightarrow 2 gluon \rightarrow 1 gluon \rightarrow 2 gluon \rightarrow 1 gluon \rightarrow 2 gluon.

The **muon** is equivalent with the **naked (anti) green d(own)-quark**

The **tau** is equivalent with the **naked (anti) red b(ottom)-quark**

The differences between:

e- and \bar{u} , is one gluon,
 \bar{u} and d, is one gluon,
d and s, is one gluon changed form into an e-
s and \bar{c} , is one gluon,
 \bar{c} and b, is one gluon changed form into an e-
b and \bar{t} , is one gluon.

Quark "down-grading or decay" is going down the energy ladder, "spitting out" e-, e+'s and gluons in their original form (unchanged) or changed into neutrino's.

Quark stability is originated by the sub-quantum structure of the quark
If the structure has

1: an A-symmetric form (such as the (anti-)blue u-,s- and b-quarks), the ability to spin, and the stability is minor to those with a symmetric form.

2: more components, this will lead to:decrease of stability and mass increase due to more protuberances (more vulnerability for Higgs impulses) resp. more production of gravitons)

Lifetimes and decay routes of quarks should be dependant of these rules, but we see interesting changes:

The preferred (anti-) red-blue- green sequences of the decay ladders are changing between the charm and the bottom quarks.

The differences in the sequences of charges related to the mass ladder is not clear. Further investigation is needed.

Systematic summary of basic quark decay modes.

e- and e+ \Rightarrow UOU = general photon (anihilation)

$\bar{u} \Rightarrow e-, \bar{\nu}_e$	$\left \begin{array}{l} \text{ORO} \Rightarrow \text{ORO} = e- \\ \text{LOL} \Rightarrow \text{LRL} = \bar{\nu}_e \end{array} \right.$	$u \Rightarrow e+, \nu_e$	$\left \begin{array}{l} \text{OLO} \Rightarrow \text{OLO} = e+ \\ \text{ROR} \Rightarrow \text{RLR} = \nu_e \end{array} \right.$
---------------------------------------	---	---------------------------	---

$\bar{u} \Rightarrow e-$	$\left \begin{array}{l} \text{ORO} \Rightarrow \text{ORO} = e- \\ \text{LOL} \Rightarrow \text{gluon sea} \end{array} \right.$	$u \Rightarrow e+$	$\left \begin{array}{l} \text{OLO} \Rightarrow \text{OLO} = e+ \\ \text{ROR} \Rightarrow \text{gluon sea} \end{array} \right.$
--------------------------	---	--------------------	---

$\bar{u} \Rightarrow \bar{\nu}_\mu$	$\left \begin{array}{l} \text{ORO} \Rightarrow \text{RRR} = \bar{\nu}_\mu \\ \text{LOL} \Rightarrow \text{gluon sea} \end{array} \right.$	$u \Rightarrow \nu_\mu$	$\left \begin{array}{l} \text{OLO} \Rightarrow \text{LLL} = \nu_\mu \\ \text{ROR} \Rightarrow \text{gluon sea} \end{array} \right.$
-------------------------------------	--	-------------------------	--

(d (anti-)green is also: μ)

$d \Rightarrow e-, \bar{\nu}_e, \nu_\mu$	$\left \begin{array}{l} \text{ORO} \Rightarrow \text{ORO} = e- \\ \text{LOL} \Rightarrow \text{LRL} = \bar{\nu}_e \\ \text{LOL} \Rightarrow \text{LLL} = \nu_\mu \end{array} \right.$	$\bar{d} \Rightarrow e+, \nu_e, \bar{\nu}_\mu$	$\left \begin{array}{l} \text{OLO} \Rightarrow \text{OLO} = e+ \\ \text{ROR} \Rightarrow \text{RLR} = \nu_e \\ \text{ROR} \Rightarrow \text{RRR} = \bar{\nu}_\mu \end{array} \right.$
--	--	--	--

$\pi^- \Rightarrow \mu-, \nu_\mu$	$d = \mu-$	$\pi^+ \Rightarrow \mu+, \nu_\mu$	$\bar{d} = \mu$
$d\bar{u}$	$\bar{u} \left \begin{array}{l} \text{ORO} \Rightarrow \text{RRR} = \bar{\nu}_\mu \\ \text{LOL} \Rightarrow \text{gluon sea} \end{array} \right.$	du	$u \left \begin{array}{l} \text{OLO} \Rightarrow \text{LLL} = \nu_\mu \\ \text{ROR} \Rightarrow \text{gluon sea} \end{array} \right.$

$K^- \Rightarrow \mu-, \nu_\mu$	$\bar{u} \left \begin{array}{l} \text{ORO} \Rightarrow \text{RRR} = \bar{\nu}_\mu \\ \text{LOL} \Rightarrow \text{gluon sea} \end{array} \right.$	$K^+ \Rightarrow \mu+, \nu_\mu$	$u \left \begin{array}{l} \text{OLO} \Rightarrow \text{LLL} = \nu_\mu \\ \text{ROR} \Rightarrow \text{gluon sea} \end{array} \right.$
$s\bar{u}$		$\bar{s}u$	

$s = \left \begin{array}{l} \text{ORO} \Rightarrow \text{ORO} \\ \text{ORO} \Rightarrow \text{LOL} \\ \text{LOL} \Rightarrow \text{LOL} \end{array} \right = \mu^-$	$\bar{s} = \left \begin{array}{l} \text{OLO} \Rightarrow \text{OLO} \\ \text{OLO} \Rightarrow \text{ROR} \\ \text{ROR} \Rightarrow \text{ROR} \end{array} \right = \mu^+$
---	---

Three different kinds of Weak interactions.

Hydronic decays:

$\Lambda_0 \Rightarrow \pi^- + p$
 $uds \Rightarrow udd \Rightarrow \bar{u}d + uud$
 The principle interaction is:

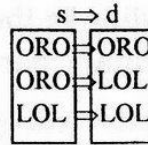

$s \Rightarrow d$ and pair production (addition) of u and \bar{u} from the Higgs and gluon "sea"

semi-leptonic processes

$n \Rightarrow p + e^- + \bar{\nu}_e$
 $ddu \Rightarrow duu + e^- + \bar{\nu}_e$
 The principle interaction is :
 $d \Rightarrow u + e^- + \bar{\nu}_e$

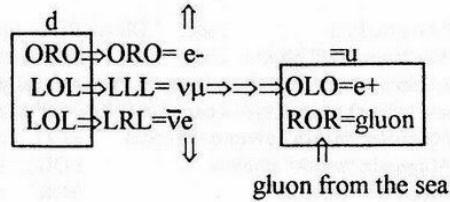

leptonic processes

$\mu^- \Rightarrow e^- + \bar{\nu}_e + \nu_\mu$
 $d \Rightarrow e^- + \bar{\nu}_e + \nu_\mu$

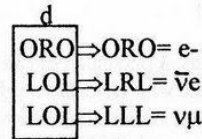

Some electromagnetic decays.

$\pi_0 \Rightarrow \gamma + \gamma$ **ORO+OLO annihilation** $\Rightarrow 1x \gamma$
 $u\bar{u} \Rightarrow 2 \gamma$

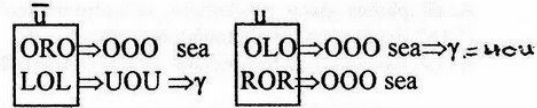

$\eta_0 \Rightarrow 2\gamma$ **ORO+OLO annihilation** $\Rightarrow 1x \gamma$
 only: $\bar{d}d$ decays $\Rightarrow 2\gamma$
 so first: $\bar{s}s \Rightarrow \bar{d}d$.

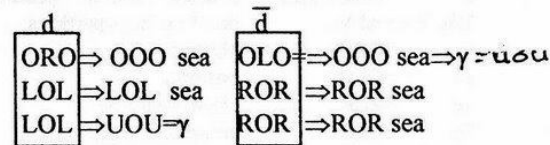

$\Sigma_0 \Rightarrow \Lambda_0 + \gamma$
 $uds \Rightarrow sdu + \gamma$ $d \Rightarrow \bar{u} \Rightarrow d$

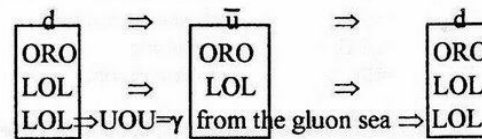

Some strong interactions.

$\Lambda^{++} \Rightarrow p + \pi^+ : uuu \Rightarrow duu + u\bar{d}$
 $\uparrow \text{---} \uparrow$
 $d\bar{d}$ pair production from the Higgs and gluon sea

$\Delta_0 \Rightarrow p + \pi^- : ddu \Rightarrow duu + d\bar{u}$
 $\uparrow \text{---} \uparrow$
 $u\bar{u}$ pair production from the Higgs and gluon sea

$\Delta_0 \Rightarrow n + \pi_0 : ddu \Rightarrow ddu + u\bar{u}$
 $\uparrow \text{---} \uparrow$
 $u\bar{u}$ pair production from the Higgs and gluon sea

The double spin of Fermions.

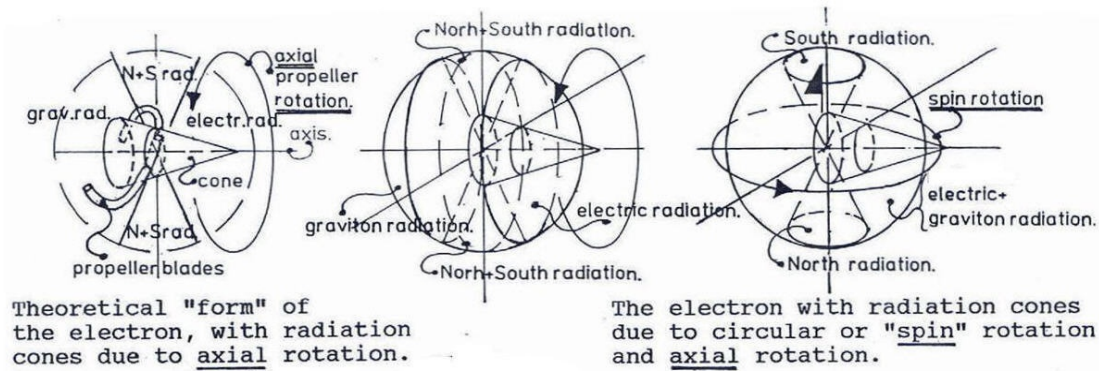

The "Eigen energy" distribution around the spinning Fermion propeller, is supposed to come in cone form. The Fermion spin and radiation is the product of a scattering process with oscillating Higgs vacuum particles. As a result, the Fermion has a double spin around two polar axes. This is supposed to be the origin of a dipole Magnetic field with North and South monopole photon radiation and the circular distribution of graviton and electric radiation. In addition it must be stated that all Fermions are entangled with their object /subject particle far away.

Figure 8, double spin of Fermion and Quark propellers.

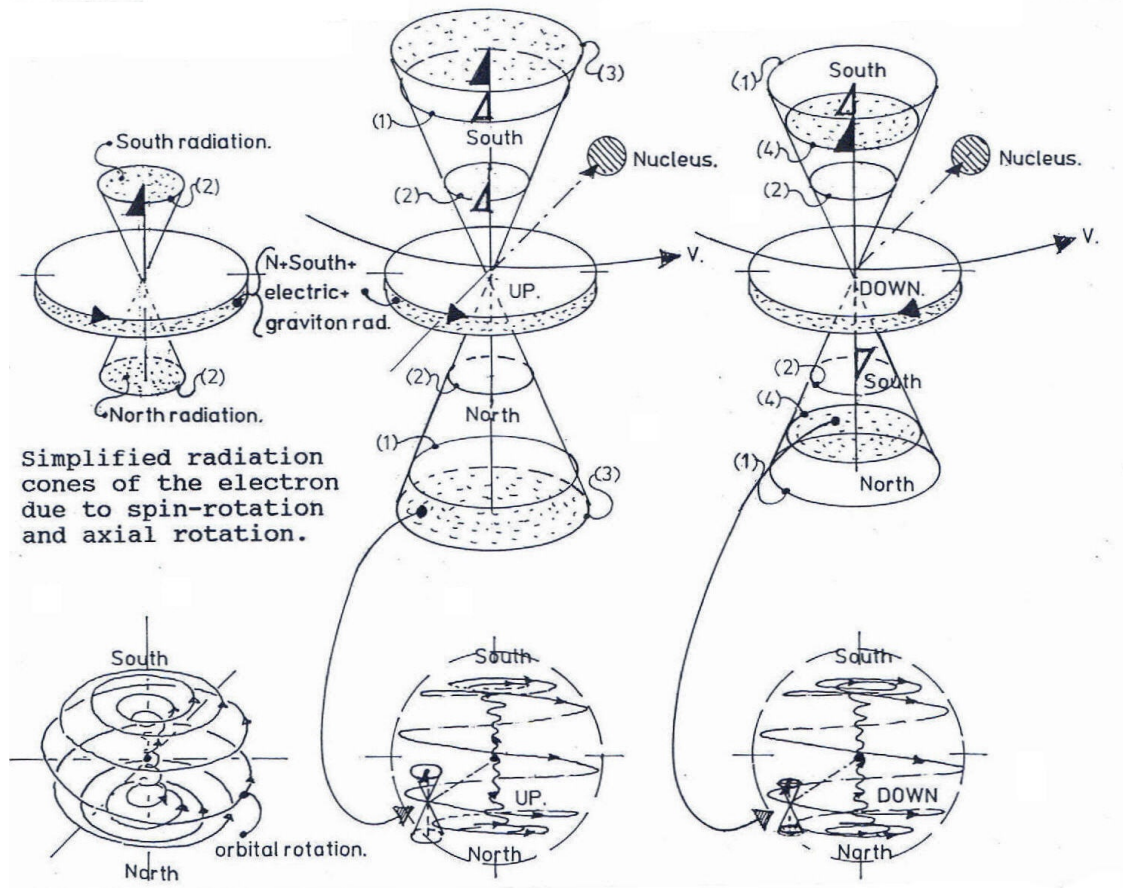
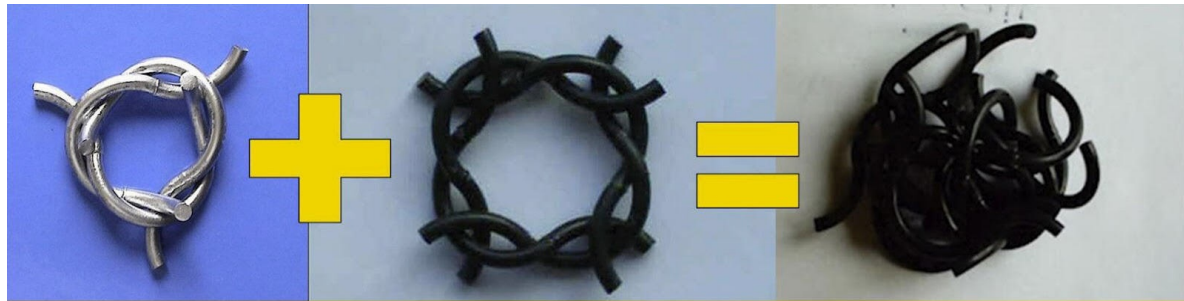
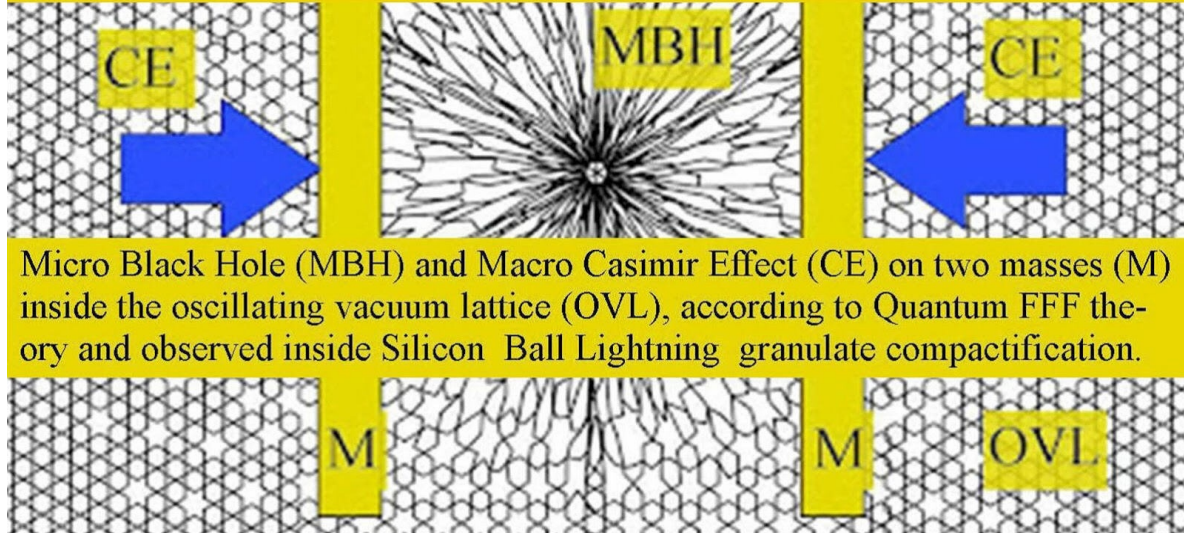

Figure 9, The difference between up and down Atoms.



How a Ball Lightning Micro Black Hole is made?



Micro Black Hole (MBH) and Macro Casimir Effect (CE) on two masses (M) inside the oscillating vacuum lattice (OVL), according to Quantum FFF theory and observed inside Silicon Ball Lightning granulate compactification.

Figure 10, Micro Black Hole production by interference of 3x magnetic North or South photons or 4x general photons

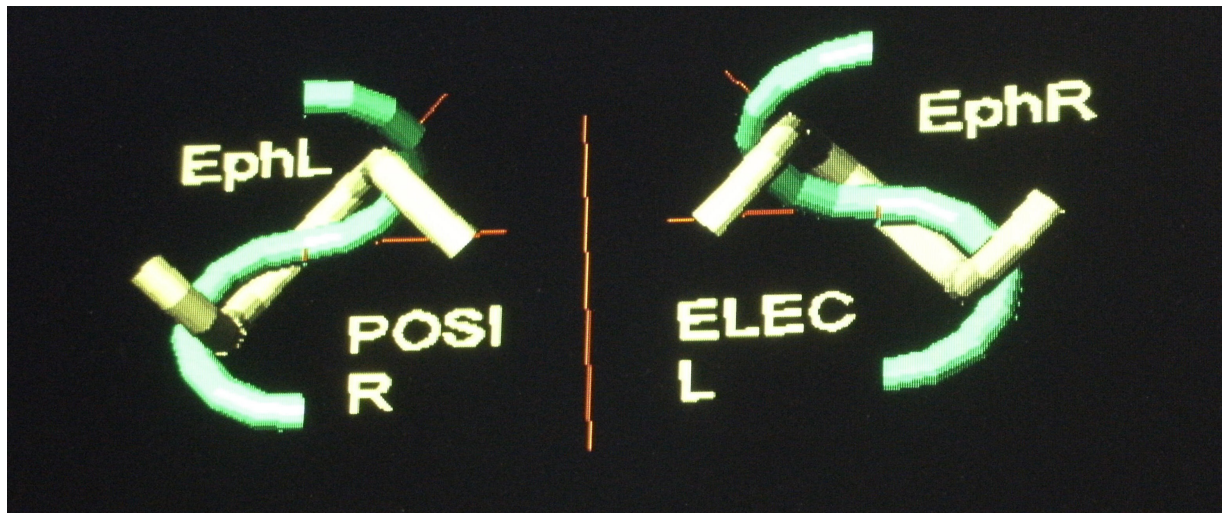

Figure 11, How particles knot together by a click-on connection.

The OLD and NEW Black Hole differences.

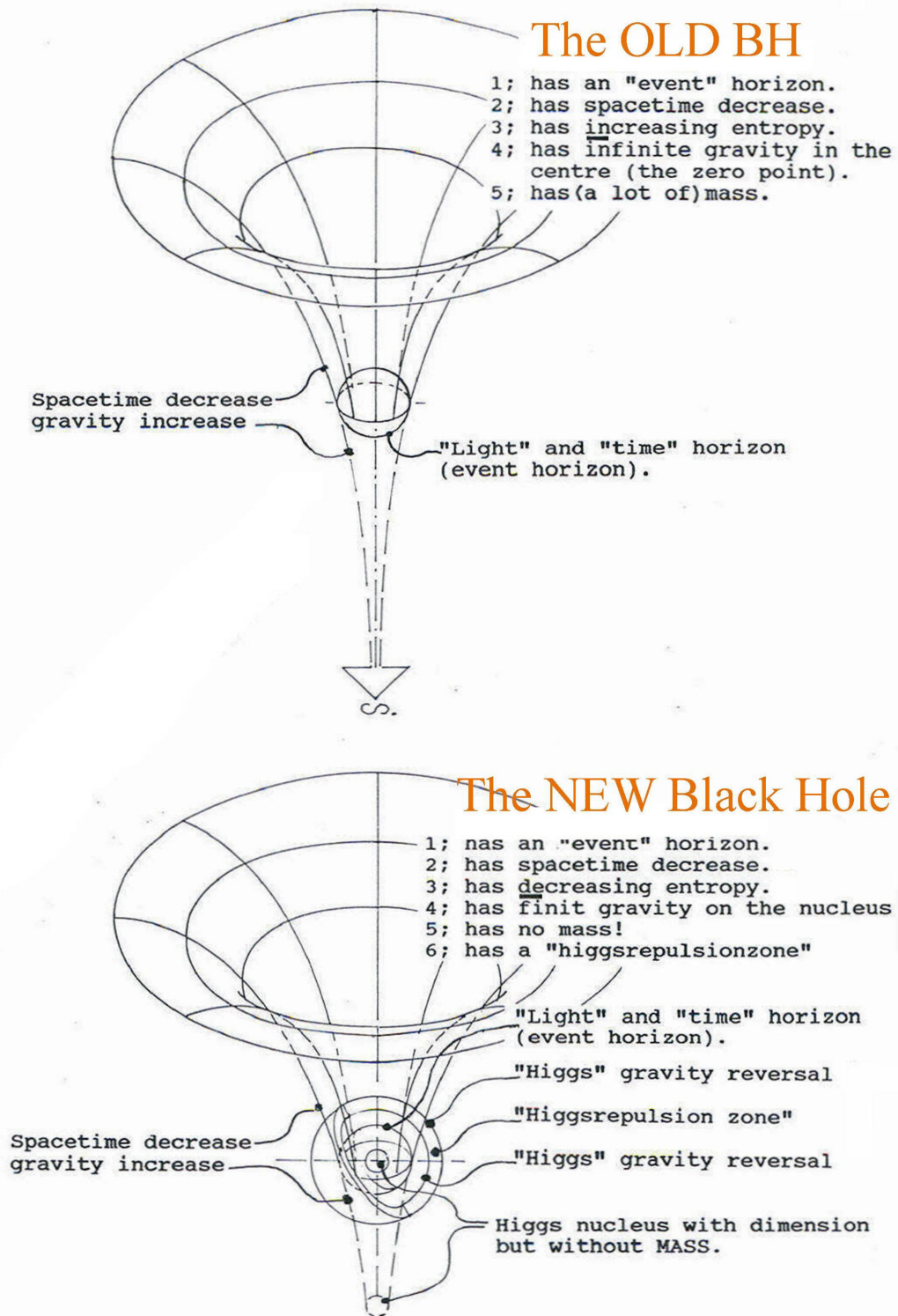

Figure 12, Comparison between the Old and New Black hole.

References:

- [1] [viXra:1111.0096](#) *submitted on 2011-11-29* **Reconciliation of QM and GR and the Need for a Pulsating Entangled CPT Symmetric Raspberry Shaped Multiverse.**
- [2] [viXra:1111.0061](#) *submitted on 15 Nov 2011*
Black Hole Horizon Curvature Dependent Balance Between Plasma Creation and e-e+ Annihilation in Quantum FFF Theory.
- [3] [viXra:1108.0036](#) *replaced on 21 Sep 2011*
Artificial Ball Lightning Production and Exploitation Device for Zero Point Electric Energy Usage.
- [4] [viXra:1108.0006](#) *submitted on 3 Aug 2011*
Mass in Motion in Quantum FFF Theory
- [5] [viXra:1104.0083](#) *submitted on 28 Apr 2011*
Quantum FFF Theory in Posters.
- [6] [viXra:1104.0044](#) *submitted on 13 Apr 2011*
Ball Lightning, Micro Comets, Sprite-Fireballs and X-Ray/gamma Flashes According to Quantum FFF Theory
- [7] [viXra:1104.0002](#) *submitted on 1 Apr 2011*
Stellar Anchor Black Holes as the Remnants of Former Herbig Haro Objects
- [8] [viXra:1103.0097](#) *submitted on 23 Mar 2011*
ZPE Zero Point Energy Examples Around Black Holes.
- [9] [viXra:1103.0068](#) *submitted on 16 Mar 2011*
Funktion Follows Form, at the Quantum Scale and Beyond.
- [10] [viXra:1103.0024](#) *replaced on 24 Mar 2011*
Quantum Gravity and Electro Magnetic Forces in FFF-Theory.
- [11] [viXra:1103.0015](#) *submitted on 5 Mar 2011*
Wavefunction Collapse and Human Choice-Making Inside an Entangled Mirror Symmetrical Multiverse.

- [12] Clumpy: a code for γ -ray signals from dark matter structures
Ald'ee Charbonniera, C'eline Combetb,c, David Maurina,b,c,d
<http://arxiv.org/abs/1201.4728>
- [13] [viXra:1103.0002](#) *replaced on 2011-12-3*
- 3-Dimensional String Based Alternative Particles Model**
- [14] [viXra:1102.0056](#) *submitted on 28 Feb 2011*
- Experiments to Determine the Mass Related Lightspeed Extinction Volume Around the Earth and Around Spinning Objects in the Lab.**
- [15] [viXra:1102.0054](#) *submitted on 27 Feb 2011*
- Atomic Nuclear Geometry Based on Magic Number Logic.**
- [16] [viXra:1102.0052](#) *submitted on 27 Feb 2011*
- Construction Principles for Chiral "atoms of Spacetime Geometry".**
- Authors:** [Leo Vuyk](#)
- [17] Book: "**The New God Particle and Free Will**".
Author: Leo Vuyk, LuLu publishers, 2008.
ISBN number 978-1-4092-1031-3
<http://www.amazon.co.uk/NEW-GOD-PARTICLE-FREE-WILL/dp/1409210316>
- [18] E-Book: "**Zero Point Energy Black Holes**"
Author: Leo Vuyk, LuLu publishers, 2011.
<http://www.lulu.com/product/ebook/zero-point-energy-black-holes/152399515>.
- [19] Science Express 12 April 2012: Signatures of Majorana fermions in hybrid superconductor-semiconductor nanowire devices, V. Mourik et al.
- [20] Sterile Neutrinos: Wikipedia:
http://en.wikipedia.org/wiki/Sterile_neutrino