

Distribution Transformer Random Transient Suppression using Diode Bridge T-type LC Reactor

Leong Bee Keoh¹, Mohd Wazir Mustafa¹, Sazali P. Abdul Karim²,

¹ University of Technology Malaysia, Power Department, Faculty of Electrical Engineering,
81310 Skudai, Johor, Malaysia.

² Tenaga Nasional Berhad, Engineering Department, Transmission Division,
Level 4, Lobby 2, Crystal Plaza, Jalan 51A/223,46100 P.Jaya, Selangor, Malaysia.

klbee818@hotmail.com, wazir@fke.utm.my, sazalipk@tnb.com.my

Abstract. A new application of diode bridge T-type LC reactor as the transient suppressor for distribution transformer is presented. The proposed transient suppressor is effective in reducing the peak overvoltage and voltage steepness by a factor of two. The transient suppressor is connected to the upstream of the protected transformer to mitigate transients induced by lightning. The approach developed enables one to construct a simple and low cost transient suppressor with negligible effects on the systems steady state operation. The proposed transient suppressor is numerically tested using simulation package PSCAD.

Keywords: Diode-bridge reactor, transient suppression, distribution transformer.

1 Introduction

Transients may occur in the repeatable fashion or random impulses. Random transients create the most consternation because they are unexplainable; occur at unpredictable times and at remote locations. These transients are difficult to define their amplitude, duration and energy content. Random transients are the result of sudden release of previously stored energy from overstress conditions such as lightning and switching parallel loads on the same branch of distribution system [1]. Random transients pose a risk to the electrical equipments such as transformers and motors, and other sensitive electrical components. They may destroy transformers and motors due to highly non-uniform initial potential distribution and internal resonant phenomena. Another serious consequence of random transients would be the loss of control in the solid-state logic systems that react to these surges. Therefore, the protection on the low voltage AC mains system especially distribution transformer from transient overvoltage is a priority power quality concern.

2 Previous Transient Suppression Methods

The transient suppressors can be grouped into two categories. One is transient suppressors that attenuate transients from propagating into other sensitive circuits. Another transient suppressor diverts transients away from sensitive loads by limiting the residual voltage [2]. Attenuating transient is accompanied by connecting filters or isolating transformers in series with the circuit. High frequency transients will be attenuated while low frequency signal will continue to flow. On the other hand, diverting a transient is accomplished with a crowbar type device or voltage-clamping device. A more detailed description will follow later in this section.

2.1 Low Pass Filter (LPF)

LPF is the most common solution to the transient overvoltage problem. LPF, for example, capacitor is installed between the source of transient and the sensitive loads. The impedance of the LPF forms a voltage divider with the source impedance, thus attenuating the high frequency transients. Some disadvantages of capacitor LPF are; a) high voltage peaks due to resonance with other inductive components, b) high inrush currents upon switching, c) excessive reactive loads on the power system voltage [2]. RC snubber can be used to reduce these side effects of capacitor LPF. However, the added resistance is very costly and large in size. Thus, limits its applicability to industrial applications. Beyond the RC snubber, conventional LC filters are widely used as transient protection. LC filters are effective transient suppressors provided the filter's front-end component can withstand the high voltage associated with the transients [2].

2.2 Isolation Transformers

Isolation transformer works in the way that the transients are block from passing from primary windings to the secondary windings. Isolation transformers are useful in breaking ground loops, i.e. blocking common-mode voltages. However, isolation transformers have disadvantages like: a) provides no differential-mode attenuation, b) provides no voltage regulation [1].

2.3 Crowbar Device

Crowbar device such as gas tubes and carbon-block protectors, involve a switching action through breakdown of gas between electrodes or turn on of a thyristor. The low impedance path after switching on will divert the transient away from the parallel connected loads. Some limitations of crowbar device are; a) loads are unprotected during initial transient rise, b) "Follow-current" or "power-follow" phenomena where

a power current from the voltage source will follow the surge discharge. This power follow current may not be cleared at a natural current zero in AC and DC circuits [2].

2.4 Voltage-Clamping Device

Voltage-clamping device, such as reverse selenium amplifiers, zener diodes, silicon carbide varistors, metal-oxide varistors; have varying impedance that depends on the current flowing through the device or the voltage across the terminals. The variation of the impedance is monotonic which exhibits a turn on action [1]. However, these transient suppressors are ineffective with zero source impedance.

3 New Transient Suppression Approach

For transient suppressor to function with negligible effect during normal operating conditions, the following objectives must be fulfilled [3]:

- a) The suppressor should represent a significant frequency below the internal resonant frequency of transformer,
- b) The suppressor should not saturated with the load current,
- c) The suppressor should be transparent at the system frequency,
- d) The voltage drop across the suppressor must be very low,
- e) The suppressor should have low standby power.

In the present article, diode bridge T-type LC reactor is proposed as the new transient suppressor for dU/dt protection for distribution transformers. The concept is schematically presented in Fig.1 while Fig. 2 illustrates the single phase diode bridge T-type LC reactor.

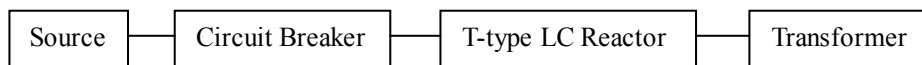

Fig.1. Idea of LC reactor placed prior to protected device.

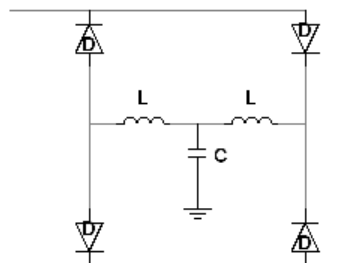

Fig. 2. Single phase Diode bridge T-type LC reactor.

The transient suppressor is connected to each phase of primary winding of three phase transformer. Its configuration is simple and no controller is required. It has negligible effect on the system steady state operation. The inductor and capacitor used in T-type LC filter are typically quite large; resulting in very low resonant frequency. For example, combination of 5H inductor and 1000 μ F capacitor will produce a resonant frequency of as low as 2.25Hz. For 50Hz power supplies, the lowest frequency the filter will ever see is 100Hz, which is well above its resonant point. Therefore, the potential of resonance take place in T-type LC reactor is completely avoided. The only side effect of the reactor will be forward voltage drop across the rectifier diode which resulting in reactor discharge gradually and producing a current ripple through it [4]. The proposed transient suppressor has two modes of operation, charging mode and discharging mode which will further discussed in the following section.

2.1 Charging Mode

The single phase equivalent circuit of charging mode is shown in Fig. 3. When the transformer is energized, a pair of diodes is turn on. A.C. current gets dropped across the first inductor and is not allowed to reach the output. The remaining part of the a.c. component is by passed through the shunt capacitor. In practice, a small amount of ripple still remains in the output voltage. The second inductor will filter the remaining ripples. Thus, the voltage across reactor limits the transient voltage from passing to the distribution transformer soon after any fault with negligible ripple factor [4].

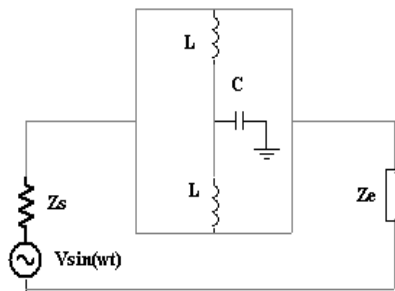

Fig. 3. Charging mode.

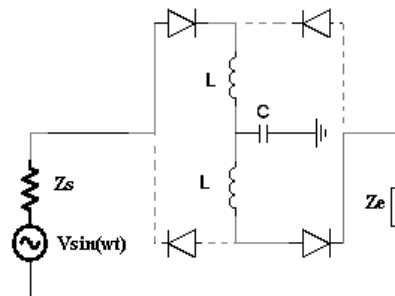

Fig. 4. Discharging mode.

2.2 Discharging Mode

Discharging mode starts when the inrush current reaches its maximum value. In discharging mode, all diodes are conducting because LC reactor released its energy stored during charging state. During discharging state, the LC reactor freewheels and the voltage across LC reactor terminals is nearly zero, behaving like a short circuit, giving no effect on the system operation. The single phase equivalent circuit of discharging mode is shown in Fig. 4.

5 PSCAD/EMTDC Simulation Results

In order to demonstrate the applicability of diode bridge T-type LC reactor to mitigate high dU/dt transients resulting from lightning, PSCAD simulations were performed for a realistic case of distribution transformer (1MVA, 22/0.69kV) connected to a 22kV distribution network. It is assumed that the fault of single line-to-ground occurred at $t = 0.26$ seconds and this fault is removed at $t = 0.31$ seconds. Fig. 5 shows the circuit implementation in PSCAD.

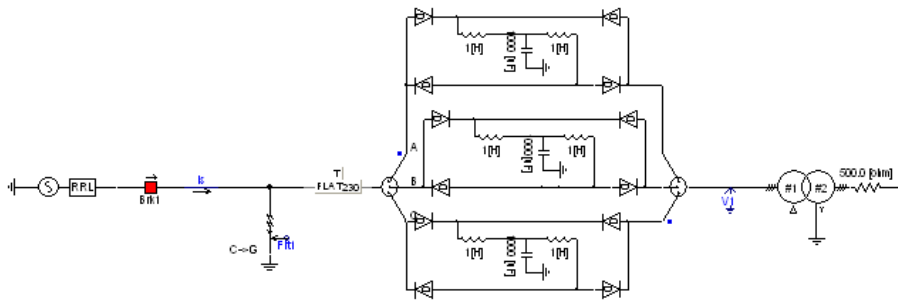
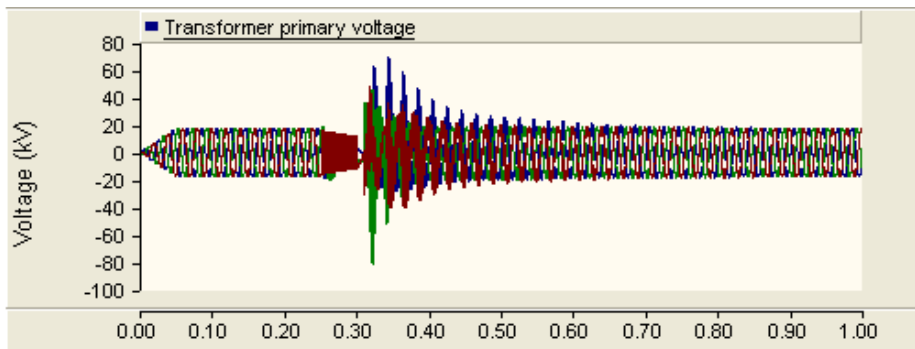

Fig. 5. Single line diagram of the case study.

5.1 Peak Overvoltage Reduction

Voltage waveforms at the transformer primary side are shown in Fig.6 a) no transient protection, b) with transient protection. It is observed that overvoltage for circuit without transient suppressor last for more than 200ms after removal of fault. The unprotected transformer would experience the phase-to-ground voltage of peak value 80kV. By selecting appropriate inductance and capacitance value of LC reactor to be $L = 1H$ and $C = 1000\mu F$, the peak overvoltage can be reduced to 40kV, which is half of the unprotected transformer.



(a) No transient protection.

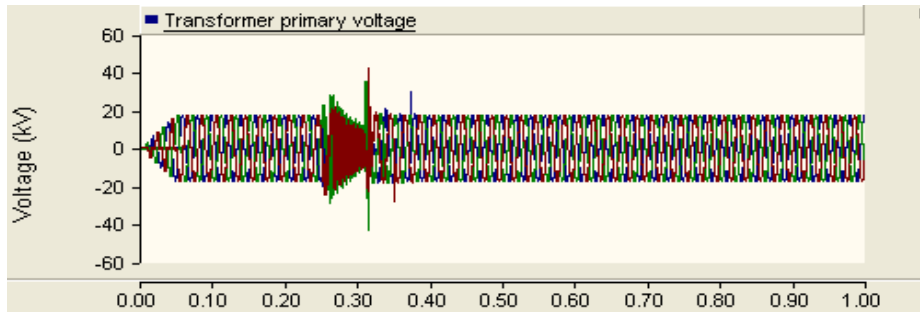

(b) With transient protection.
Fig. 6. Comparison of voltage waveform measured at the transformer primary side.

5.2 dU/dt Reduction

The unprotected transformer experienced a peak overvoltage of exceeding 80kV, characterized by a dU/dt of 2.23 kV/ μ s. If the T-type LC reactor is installed upstream the protected transformer, it will act as a filter, reducing the peak voltage surge to 40kV, in consequence, reducing the dU/dt value to 1.19 kV/ μ s. The results obtained indicated that using the proposed transient suppressor, a reduction in both dU/dt and peak overvoltage value by a factor of two was achieved.

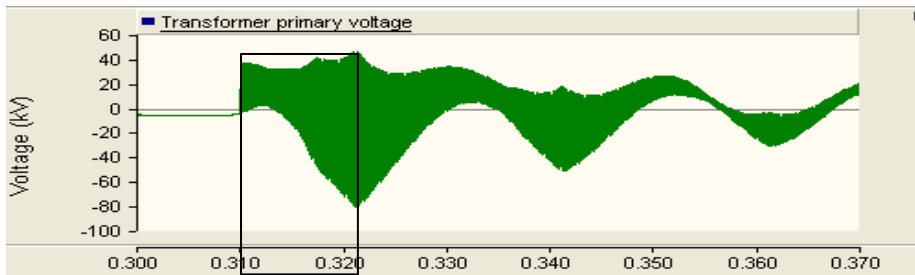

(a) No transient protection.

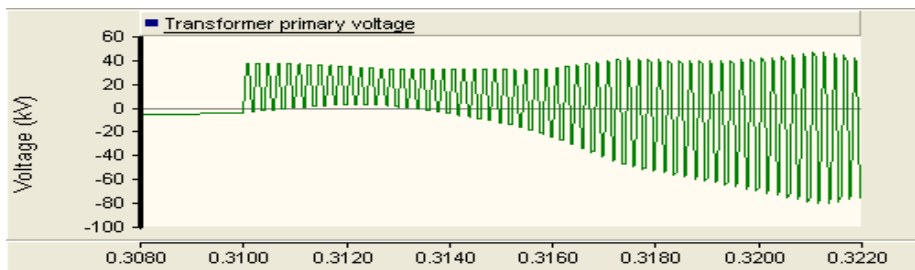

(b) Larger view of (a).

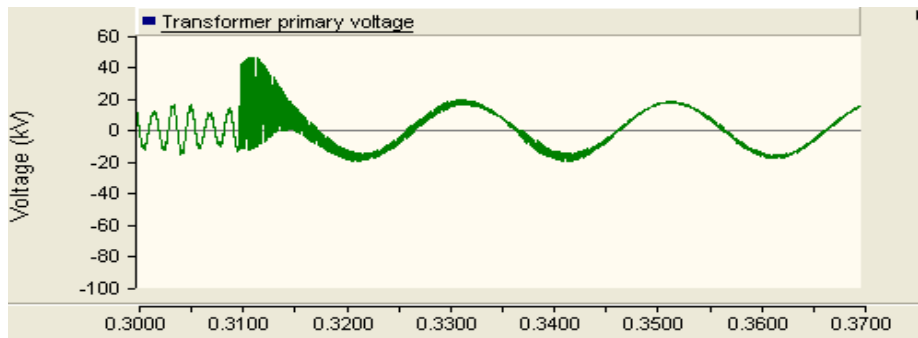

(c) With transient protection.

Fig. 7. Comparison of voltage waveform with transient suppressor and without transient suppressor.

5.3 Restrike Reduction

Multiple restrikes were observed in the case without transient protection as shown in Fig. 7(a). Protecting the transformer with the set of LC reactor significantly reduce the number of restrikes as shown in Fig. 7(c).

5.4 Inrush Current Reduction

The important information derived from Fig.8 is the proposed transient suppressor effectively reduced the peak inrush current more than two times. Besides, it shorten the duration of inrush current which means inrush current dies out faster in the case with transient suppressor.

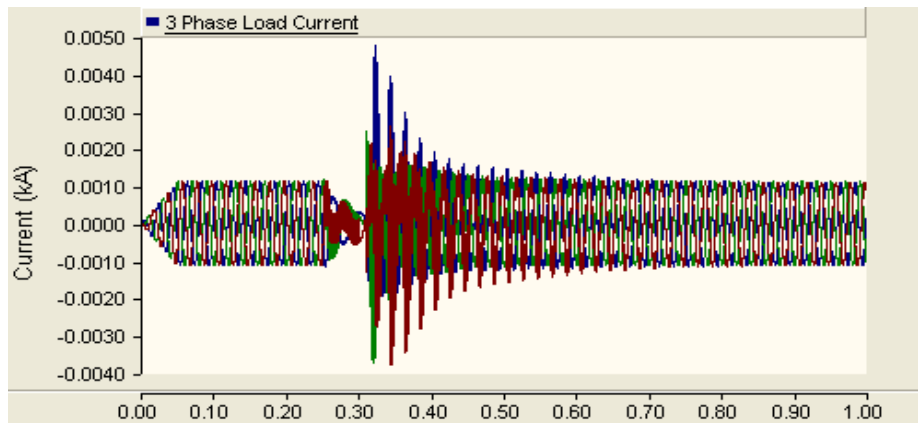

(a) No transient protection.

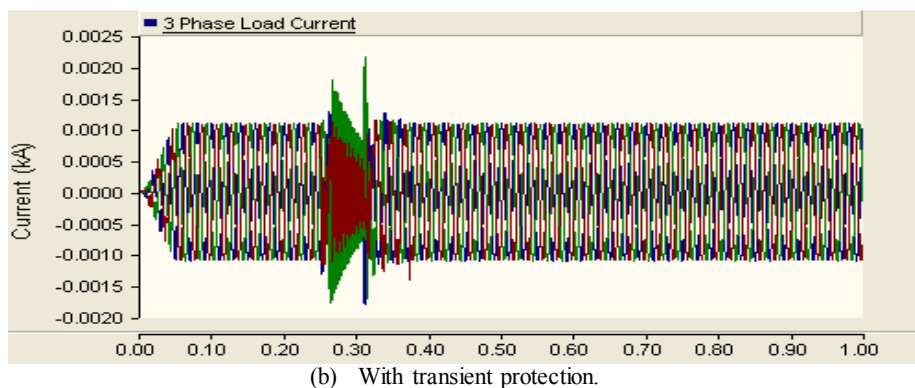

Fig. 8. Comparison of current waveform with transient suppressor and without transient suppressor.

6 Conclusion

A new distribution transformer transient suppressor against transient overvoltage in a form of diode bridge T-type LC reactor was presented. It was demonstrated that the use of these transient suppressor significantly reduces the peak overvoltage and voltage steepness by a factor of two during lightning surges. The proposed transient suppressor also has the ability to eliminate inrush current effectively. In practice, since distribution transformers are used to step down voltage level from high voltage to low voltage, thus, the proposed transient suppressor can be applied to high voltage system by increasing the insulation level of the transient suppressor. Further works are the experimental verification, transient suppressor optimization, and consideration of other application of the proposed transient suppressor to transmission systems.

References

1. Suresh Kumar.K.S, "Transient overvoltages in electrical distribution system and suppression techniques," Available at www.nalanda.nitc.ac.in/nitcresources/ee/.../VoltageTransients.pdf
2. "Application Note: Transient suppression devices and principles", Littelfuse, Inc, 1998. Available at www.littelfuse.com/data/en/Application_Notes/an9768.pdf
3. W.Piasecki, G.Bywalec, M.Florkowski, M.Fulczyk, J.Furgal, "New approach towards very fast transients suppression," in International Conference on Power System Transients (IPST'07), Lyon, France, 2007.
4. M.W.Mustafa, L.B.Keoh, P.A.K.Sazali, "Diode bridge T-type LC reactor as transformer inrush current limiter," International Journal of Electronics Communication and Electricals Engineering, Volume 2 issue 1. Available at <https://sites.google.com/site/ijeceejournal/volume-2-issue-1>