

# A Challenge to Quantized Absorption by Experiment and Theory

By Eric S. Reiter, Unquantum Laboratory, eric@unquantum.net, Pacifica, CA. July, 2012.

## Introduction

In this essay quantum mechanics (QM) implies all of its variants that embrace quantized absorption and emission. There are many reasonable arguments<sup>(1\*, 2†)</sup> against QM. With all its bizarre implications, QM has nevertheless flourished for 100 years. QM endured because a vast body of experimental work can be interpreted to fit its predictions. Therefore, to identify false assumptions behind QM with strong justification, new experimental evidence contradicting QM is required. Such new evidence is presented here. The new evidence is pivotal, requiring its experimental description in detail.

By QM and the photon model, a singly emitted "photon" of energy  $h \nu_L$  must not trigger two coincident detections in a beam-split test,<sup>(3, 4)</sup> where  $h$  = Planck's constant of *action*,  $\nu_L$  = electromagnetic or light frequency. Beam-split coincidence tests of the past have confirmed QM by measuring only an accidental chance coincidence rate.<sup>(5-8)</sup> A series of these new experiments with gamma-rays ( $\gamma$ ) directly contradicts this foundational prediction of QM. The detectors employed had high energy resolution, whereby their pulse-height (energy) is proportional to  $\nu_L$ . The  $\gamma$  detection pulses were within a full-height window, indicating we are not dealing with frequency down-conversion. Tests herein show evidence of a pre-loaded state in the long abandoned accumulation hypothesis, also known as the loading theory.<sup>(9-16)</sup> To measure this *unquantum* effect, a fraction of energy would have to be present in the detector molecules preceding the event of incoming energy. This energy came from previous absorption that did not yet fill a threshold. This contradicts energy conservation in terms of particles.<sup>(17)</sup> The test gives us a choice: we either give up an always-applicable particle construct, or give up energy conservation altogether. We choose to uphold energy conservation. The new evidence violates *particle-energy* conservation.

Tests herein all have a similar strategy. A beam-split test compares an expected chance coincidence rate  $R_c$  to a measured experimental coincidence rate  $R_e$ . Prior tests<sup>(5-8)</sup> gave  $R_e/R_c = 1$ , and admit exceeding unity contradicts QM. Described here are the only tests revealing  $R_e/R_c > 1$ , clearly contradicting the one-to-one probability prediction of QM. Prior tests have pitted QM only against an overly classical model.

After developing the loading theory in 2000<sup>(18)</sup> and suspecting false assumptions in past beam-split tests, a test with  $\gamma$ -rays was undertaken. A test with  $\gamma$ -rays is fair to both the loading theory and photon theory. It is counter intuitive to attempt a test to contradict the photon model with what is thought to be the most particle-like form of light,  $\gamma$ . To trigger a detection event from a pre-loaded state is evidence of unquantized continuous absorption whereby  $h$  is understood as a maximum. This idea of *action* allowed below  $h$  is algebraically equivalent to "Planck's second theory"<sup>(10, 11, 15, 16)</sup> of 1911 (ref. 10, translation available at <http://www.unquantum.net>). In his second theory, Planck took *action* as a property of matter, not light.<sup>(11)</sup> Also, the new tests imply that it was a false assumption to think  $h$  is due to a property light. The loading theory assumes light is quantized at energy  $h\nu_L$  at the instant of emission, but thereafter spreads classically. Similar new beam-split tests with alpha-rays, contradicting QM with  $R_e/R_c > 1$ , are also described herein.

---

\* An early reference; one of many similar cases.

† A recent reference; one of many similar cases.

## Gamma-ray Beam-Split Tests

In a test of unambiguous distinction between QM and the loading theory, the detection mechanism must adequately handle both time and energy in a beam-split coincidence test with two detectors, as shown in the following analysis. Surprisingly, discussions of pulse energy (height) resolution have not been addressed in past tests,<sup>(5-8)</sup> which were performed with visible light and one test with x-rays. Referring to **fig. 1** we will analyze the photomultiplier tube (PMT) pulse-height response to monochromatic visible light.<sup>(19)</sup> A single channel analyzer instrument **SCA** creates a **window** of pulse heights  $\Delta E_{\text{window}}$  to be measured (and timed in other tests); **LL** is lower level and **UL** is upper level (**bold** denotes notation in figures). If we set **LL** to less than half  $E_{\text{mean}}$ , one could argue we favored a loading model because a down-conversion might take place that would record coincidences in both detectors. Also, if **LL** were set too low, one could argue we were recording false coincidences due to noise. If we set **LL** higher than half  $E_{\text{mean}}$ , one could argue we were unfair to the loading theory by eliminating too many pulses that would have caused coincidences. Therefore a fair test requires high pulse-height resolution:  $E_{\text{mean}} \gg \Delta E_{\text{window}}$ . This criterion is not possible with a PMT or any visible light detector, but is easily met with  $\gamma$  and scintillation detectors.

A high photoelectric effect efficiency in the detector at the frequency of chosen  $\gamma$  was judged to enhance the  $\gamma$ -split effect, and was tested to be true. The single 88 KeV  $\gamma$  emitted in spontaneous decay from cadmium-109, and detected with *Nal(Tl)* scintillators fit this criterion<sup>(20)</sup> and worked well. All radioisotopes used in this essay were low-level license-exempt.

The  $\gamma$  test of July 5, 2004<sup>(21 fig. 6)</sup> will be described in detail, and others briefly. After spontaneous decay by electron capture, *Cd-109* becomes stable *Ag-109*. *Cd-109* also emits a low energy x-ray far below **LL**. We know that only one  $\gamma$  is emitted at a time from a coincidence test with the isotope placed between two facing detectors to read close to  $4\pi$  solid angle.<sup>(22)</sup> This test only reveals chance, measured by

$$R_c = R_1 R_2 \tau \quad \text{Eq. 1,}$$

where  $R_1$  and  $R_2$  are the singles rates from each detector and  $\tau$  is a time window that was pre-set to measure coincidence.

The test was performed with two detectors like those shown in **fig. 2**, each being an *Nal(Tl)* crystal coupled to a PMT. The *Cd-109* source was inside a tin collimator placed directly in front of detector #1, a custom made 3 mm thick 40 x 40 mm crystal. Directly behind detector #1 was detector #2, a 1.5" *Bicron Nal-PMT*. This thin-and-thick detector arrangement is tandem geometry. This test was performed inside a lead shield<sup>(23)</sup> that lowered the background rate 1/31.

Referring to **fig. 3**, the components are an *Ortec 460* shaping amplifier, an *Ortec 551 SCA*, and an

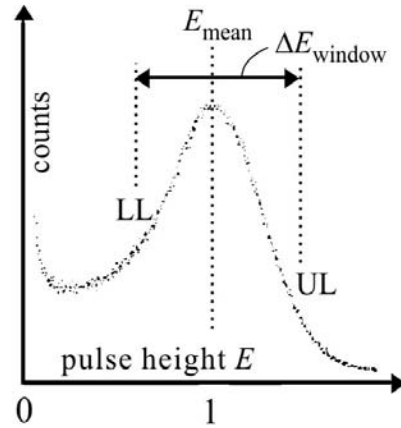

Fig. 1 PMT pulse-height response.



Fig. 2 Two gamma-ray detectors in tandem geometry; a demonstrator unit.<sup>(50)</sup> Detector #1 was used with other components for data shown.

**HP 5334 counter** for each of the two detector channels. For each detector channel, singles rates  $R_1$  and  $R_2$  are measured by (counter pulses)/(test duration). A *Lecroy LT344* digital storage oscilloscope **DSO** with histogram software monitored the analog pulses from each shaping amplifier on **Ch1** (channel 1) and **Ch2**, and the timing pulse outputs from each **SCA** on **Ch3** and **Ch4**. Stored images of each triggered analog pulse assured that the number of misshaped pulses was well below 1%. The scope triggered when a coincidence of pulses on **Ch3** and **Ch4** was present within a time window set at  $\tau = 185$  ns. This **DSO** can process pulse-height  $E$  and time difference  $\Delta t$  histograms after each triggered sweep. To assure exceeding *particle-energy* conservation, **LL** on each **SCA** window was set to  $\sim 2/3$  of the *Cd-109*  $\gamma$  characteristic pulse-height.

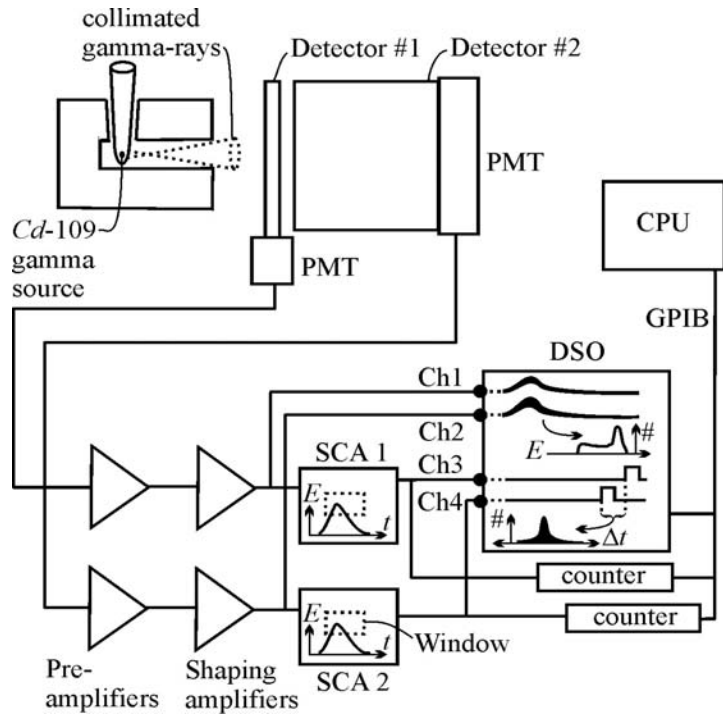

Fig. 3 Gamma-ray coincidence experiment.

Data for this test is mostly from

**fig. 4**, a screen capture from the **DSO**. A control test with no source present is  $\Delta t$  histogram trace **B** of 16 counts/40.1 ks = 0.0004/s, a background rate to be subtracted later. The chance rate from Eq. 1 was  $(291/s)(30/s)(185 \text{ ns}) = R_c = 0.0016/s$ . From trace **A** and numbers on **fig. 4**,  $R_e = 295/5.5 \text{ ks} - 0.0004/s = 0.053/s$ . The *unquantum* effect was  $R_e/R_c = 33.5$  times greater than chance. This justifies further description in terms of classical gamma-rays.

The described test is not some special case. Much critical scrutiny<sup>(21, 23)</sup> was taken to eliminate possible sources of artifact, including: faulty instruments, contamination of *Cd-113* in the *Cd-109*, fluorescence effects, cosmic rays, possibility of discovering stimulated emission, pile-up errors, and PMT artifacts. A good experimental physicist must be his own worst critic. Hundreds of similar tests (including repeats) of various form have successfully defied QM. These tests include those with different sources (*Co-57*, *Am-241*, *Na-22* pair-annihilation  $\gamma$ <sup>(24)</sup>, *Mn-54*, and *Cs-137*) and different detectors (*NaI*, high purity germanium, bismuth germinate, and *CsI*).

*Cd-109* was prepared in two chemical states of matter.<sup>(25)</sup> A salt state was prepared by evaporating an isotope solution. A metal state was prepared by electroplating the isotope in solution onto the end of a platinum wire. The *unquantum* effect from the salt state was 5 times greater than from the metal state. This discovery measures how chemistry affects nuclear electron capture in isotope decay. A similar effect was

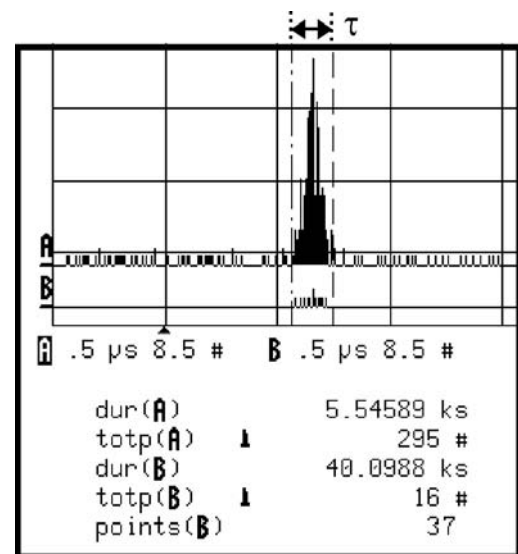

Fig. 4 Gamma-ray  $\Delta t$  from DSO.

reported<sup>(26)</sup> but was not nearly as sensitive or simple. The singles spectrum did not measurably change with this chemical state change, so this sensitivity is due to the *unquantum* effect.

The *unquantum* effect is sensitive to distance.<sup>(27)</sup> The longer wavelength  $\gamma$  from *Am-241* enhances the *unquantum* effect when placed closer to the detectors, while the shorter wavelength  $\gamma$  from *Cs-137* enhances the effect when placed farther from the detector. Therefore, we can see how the spreading cone of a classical  $\gamma$  matches to the size of the electronic scatterer. The confined spatial and temporal qualities of the  $\gamma$  are what trigger the *unquantum* effect.

In addition to tandem geometry, a beam-split geometry was explored successfully. Different materials split a classical  $\gamma$  fraction off to one side while the remaining ray passed through.<sup>(28)</sup> This beam-split geometry was developed into a spectroscopy whereby the pulse-height spectrum of the second detector was expanded. A non-shifted spectrum peak indicates elastic Rayleigh scattering. A shifted spectrum peak indicates non-elastic Compton scattering.

In beam-split geometry, crystals of silicon and germanium were explored with an apertured  $\gamma$  path to obtain angle resolution.<sup>(29)</sup> The *unquantum* effect varied with crystal orientation to reveal a new form of crystallography. This was not Bragg reflection from atomic planes, but rather from periodicity smaller than inter-atomic distance.

The *unquantum* effect is sensitive to temperature of the beam-splitter.<sup>(30)</sup> A liquid nitrogen cooled slab of aluminum delivered a 50% greater *unquantum* effect.

Magnetic effects were explored with beam-split geometry and coincident deflected pulse-height analysis.<sup>(31)</sup> A ferrite scatterer in a magnetic gap revealed enhanced Rayleigh scattering, indicating a stiff scatterer, as one would expect. A diamagnetic scatterer in a magnetic gap revealed enhanced Compton scattering, indicating a flexible scatterer, as one would expect.

The *unquantum* effect's increase/decrease response to several physical variables in the direction that made physical sense solidifies its fundamental validity. Each of the above mentioned modes of *unquantum* measurement represents an exciting discovery in itself.

There is a simple way to measure the *unquantum* effect with a single *NaI*-PMT detector and a pulse-height analyzer.<sup>(23)</sup> Measure the *Cd-109* sum-peak count rate within a pre-set  $\Delta E$  window set at twice 88 KeV, and compare to chance. The result approached chance x 2.

**Figure 5** shows the most impressive  $\gamma$ -split test.<sup>(24)</sup> Here *Na-22* emits a positron that annihilates into two 511 KeV  $\gamma$ . The decay also emits a stronger  $\gamma$  that was caught in a third detector in this triple-coincidence test, with  $R_c = R_1 R_2 R_3 \tau_{12} \tau_{23}$ . One of the annihilation  $\gamma$  was captured by two detectors in tandem. Here  $R_c/R_c = 963$ .

### Alpha-ray Beam-Split Tests<sup>(32)</sup>

Americium-241 in spontaneous decay emits a single 5.5 MeV alpha-ray ( $\alpha$ ) and a 59.6 KeV  $\gamma$ . An  $\alpha$  is the helium nucleus. This sounds like a particle, but consider a helium nuclear matter-wave. If the wave was probabilistic, the "particle" would go one way or another, and coincidence rates would only approximate chance. Hundreds of various tests were performed in three complete vacuum chamber rebuilds.

Two silicon *Ortec* surface barrier detectors with adequate pulse-height resolution were employed in a circuit nearly identical to **fig. 3**. **Fig. 6** shows the detectors and pre-amplifiers in the vacuum chamber. Vacuum pressure was not critical, and tests showed no

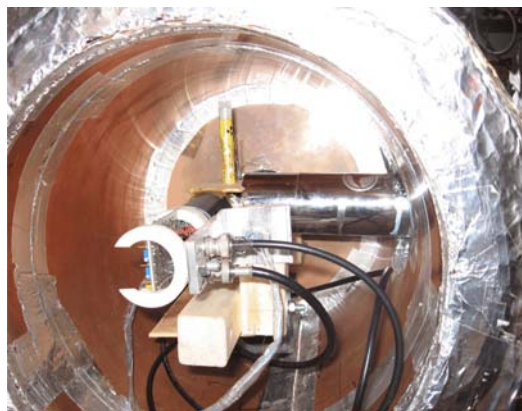

**Fig. 5** Annihilation-gamma triple-coincidence test using *Na-22*. Photo is from test of 9/2007.

difference at  $\sim 10^{-5}$  torr compared to  $\sim 10^{-3}$  torr. These tests were performed under computer CPU control by a program written in QUICKBASIC to interact with the DSO through a GPIB interface. Both SCA LL settings were at 1/3 of the characteristic  $\alpha$  pulse-height, because it was found that an  $\alpha$ -split usually maintains *particle-energy* conservation. The trigger coincidence time window was  $\tau = 100$  ns. The  $\Delta t$  histograms of **fig. 7** were from DSO screen captures.

Data of **fig. 7-a** was a two hour control test with the two detectors at right angles to each other and the *Am-241* centrally located. The chance rate was measured to assure that only one  $\alpha$  was emitted at a time. This arrangement is adequate, and  $4\pi$  solid angle capture is not practical with  $\alpha$ . Any sign of a peak is a quick way to see if chance is exceeded. Background tests of up to 48 hours with no source gave a zero coincidence count.

Data of **fig. 7-b** (Nov. 13, 2006) was from the arrangement of **fig. 6** using two layers of 24 carat gold leaf over the front of detector #1. Mounted on the rim of detector #2 were *Am-241* sources, shaded to not affect detector #2. Every analog detector pulse in coincidence was perfectly shaped.  $R_c = 9.8 \times 10^{-6}/s$ , and  $R_e/R_c = 105$  times greater than chance.

From collision experiments, the  $\alpha$  requires  $\sim 7$  MeV per nucleon to break into components, and even more for gold.<sup>(33)</sup> It would take 14 MeV to create two deuterons. The only energy available is from the  $\alpha$ 's 5.5 MeV kinetic energy. So for any model of nuclear splitting there is not enough energy to cause a conventional nuclear split.

Data from the test of **fig. 7-b** was also plotted from the CPU program shown in **fig. 8**, and was created from pulse heights plotted as dots on a two dimensional graph to show coincident pulse heights from both detectors. The singles **transmitted** and **reflected** pulse-height spectra were carefully "pasted-in." We can see that most of the  $\alpha$  pulses (dots) are near the half-height marks. It is likely that the  $\alpha$  usually just splits into lower kinetic energy *He* matter-waves, but it is possible that there is a resonance effect from the slower  $\alpha$  to cause full-height coincidences. A future test can adjust the  $\alpha$  velocity to answer this detail.

Six dots, circled, clearly exceeded *particle-energy* conservation. Counting just these 6, we still exceed chance:  $R_e/R_c = 3.97$ . This is a sensational contradiction of QM because it circumvents the argument that a particle-like split is somehow still at play.

In search for alternative explanations, we found none and conclude: continuous

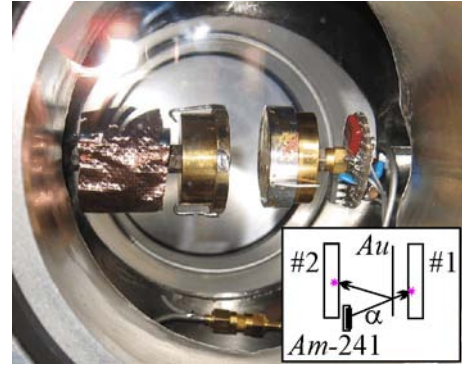

**Fig. 6** Alpha-split test in vacuum chamber.

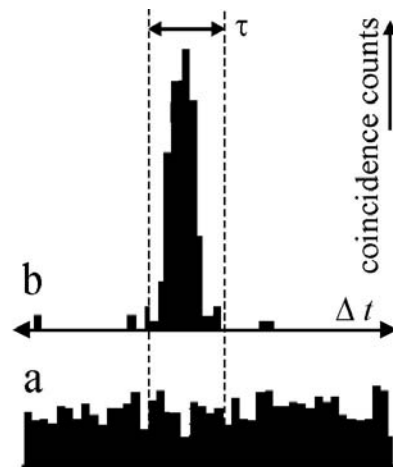

**Fig. 7** Alpha-ray  $\Delta t$  plots.

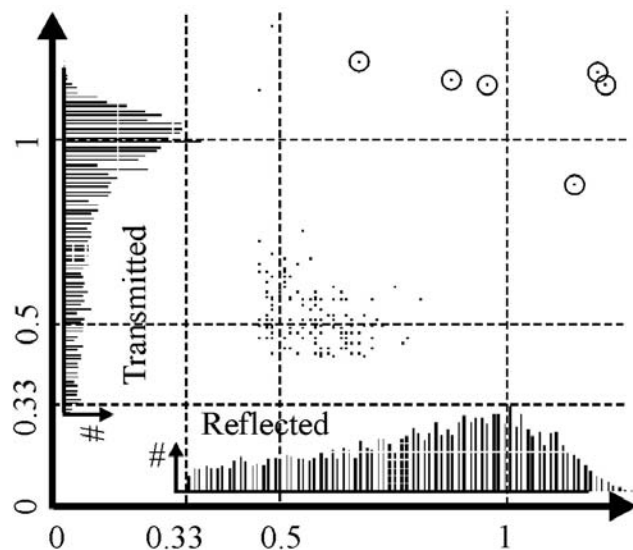

**Fig. 8** Coincident alpha pulse-height pairs.

absorption of an  $\alpha$  matter-wave was split and completed a pre-loaded state of *He* to its detection threshold. Also, the  $\alpha$ -split test demonstrates how the loading theory applies to past interference and diffraction tests with electrons, neutrons, and atoms.<sup>(34)</sup>

Several other materials were tested in transmission and reflection geometries to reveal the usefulness of this matter-wave *unquantum* effect in material science.<sup>(24)</sup> It is not necessary to use gold to exceed chance, and many materials just gave chance.

### History of the Loading Theory and its Misinterpretation

Lenard<sup>(9)</sup> recognized a pre-loaded state in the photoelectric (PE) effect with his trigger hypothesis, but most physicists ignored this idea in favor of Einstein's light quanta<sup>(35)</sup> because the PE equation worked. Planck<sup>(10, 11)</sup> explored a loading theory in a derivation of his black body law that recognized continuous absorption and explosive emission. Sommerfeld and Debye<sup>(12)</sup> explored an electron speeding up in a circle around a nucleus during resonant light absorption. Millikan<sup>(14)</sup> described the loading theory complete with its pre-loaded state in 1947, but assumed that its workings were "terribly difficult to conceive." In author's extensive search, physics literature thereafter only treats a crippled version of the loading theory with no consideration of a pre-loaded state.

Most physics textbooks<sup>(36\*)</sup> and literature<sup>(37†)</sup> routinely use photoelectric response time as evidence that the loading theory is not workable. Effectively, students are taught to think there is no such thing as a pre-loaded state. Using a known light intensity, they calculate the time an atom-sized absorber needs to soak up enough energy to emit an electron. One finds a surprisingly long accumulation time (the longest response time). They claim no such long response time is observed, and often quote  $\sim 1$  ns (the shortest response time) from the 1928 work of Lawrence and Beams<sup>(38)</sup>(L&B). The arguments unfairly compare a shortest response time with a longest response time. An absorber pre-loaded to near threshold explains the shortest response times. The longest response time from L&B was  $\sim 60$  ns. L&B did not report their light intensity, so it is not fair to compare their results to an arbitrary calculation. Energy conservation must be upheld, so an appropriate calculation is to measure the longest response time and light intensity, assume the loading theory starting from an unloaded state, and calculate the effective size of the loading complex.

The loading theory was the first and obvious model considered for our earliest experiments in modern physics. There is no excuse for the misrepresentation outlined in the previous paragraph, and this is only one example of many.<sup>(39)</sup>

### A Workable Loading Theory

The theory is elaborated for the case of the charge matter-wave, for brevity. If we develop three principles, we found they explain "quantum" and *unquantum* experiments.<sup>(18)</sup>

1. de Broglie's wavelength equation is modified to the wavelength of a beat or standing-wave envelope function of  $\Psi$ .
2. Planck's constant  $h$ , electron charge  $e$ , and mass constants like the electron mass  $m_e$  are maximum thresholds such that emission is quantized but absorption is continuous and thresholded.
3. Ratios  $h/e$ ,  $e/m$ ,  $h/m$ , are conserved as the matter-wave expands and thins-out.

In de Broglie's derivation of his famous wavelength equation<sup>(40)</sup>

$$\lambda_{\Psi} = h/m_e v_p, \quad \text{Eq. 2}$$

he devised a frequency equation

$$h\nu_{\Psi} = m_e c^2, \quad \text{Eq. 3}$$

and a velocity equation

$$v_p V_\Psi = c^2. \quad \text{Eq. 4}$$

For Eqs. 2-4, subscript  $\Psi$  is for either a matter wave or a probabilistic wave,  $\lambda_\Psi =$  phase wavelength,  $\nu_\Psi =$  phase frequency,  $v_p =$  particle velocity,  $V_\Psi =$  phase velocity, and  $m =$  electron mass. Eqs. 3 and 4 remain widely accepted, but have serious problems.

Eq. 3 is true when using  $v_L$  instead of  $v_\Psi$  to find a mass equivalent, using  $m$  instead of  $m_e$ . If we measure  $v_p$ ,  $\lambda_\Psi$ , and  $m_e$  for matter diffraction, Eq. 3 is wrong. Our experimental equations use  $h$  associated with kinetic energy, or momentum, not mass-equivalent energy.

As for Eq. 4, one might attempt to extract it from the Lorentz transformation equation of time by dimensional analysis, but its derivation independent of Eq. 2 or Eq. 3 has not been found by the author. Nevertheless, it describes an infinite  $V_\Psi$  in any particle's rest frame. Many physicists use Eq. 4 to justify the probability interpretation of QM,<sup>(41\*)</sup> but this leads to "spooky action at a distance" we are all well aware of.

A much more reasonable frequency equation is the PE effect equation  $h \nu_L = \frac{1}{2} m_e v_p^2$ , with the work function not yet encountered. It is very reasonable to understand that something about charge is oscillating at the frequency of its emitted light, but just how to replace  $\nu_L$  with a charge frequency requires insight. Recall Balmer's 1884 equation of the hydrogen spectrum in terms of frequency in its simplest form:  $\nu_L = \nu_{\Psi 2} - \nu_{\Psi 1}$ . Here  $\nu_\Psi$  is for a non-probabilistic  $\Psi$  matter-wave. The hydrogen atom is telling us that the relationship between  $\nu_L$  and  $\nu_\Psi$  is about difference-frequencies and beats. Consider that this difference-frequency property is fundamental to free charge as well as atomically bound charge. Beats, constructed from superimposing two sine waves are understood from a trigonometric identity to equal an averaged  $\Psi$  wave modulated by a modulator wave  $M$ , as graphed in **fig. 9**. If we take  $M$  as the coupling of light to charge we see that there are two beats per modulator wave, and we can write a relationship between light frequency and the frequency of charge beats:  $2\nu_L = \nu_g$ . Group velocity is commonly substituted for particle velocity, so  $v_p = v_g$ . Substituting the last two equations into the PE equation makes  $h \nu_g = m_e v_g^2$ . Groups are periodic, so we apply  $\nu_g = v_g / \lambda_g$  to derive a wavelength equation (principle 1):

$$\lambda_g = h / m_e v_g \quad \text{Eq. 5.}$$

Notice that both the PE Eq. and Eq. 5 have  $h/m_e$ . Recall several equations applicable to "wave properties of particles:" Lorentz force, PE, Compton effect, Aharonov-Bohm effect, others. They all have ratios like  $e/m$ ,  $h/m$ ,  $h/e$ . Examining  $h/m_e \equiv Q_{h/m}$ , if *action* is less than  $h$  and mass is less than  $m_e$  and the proportion is conserved, we would not be able to tell if those values went below our thresholds ( $h$ ,  $m$ ,  $e$ ) while the charge-wave spreads out and diffracts (principles 2 & 3). Therefore we can write Eq. 5 as  $\lambda_g = Q_{h/m} / \nu_g$  and the PE Eq. as  $\nu_L = \frac{1}{2} Q_{m/h} \nu_g^2$ . At threshold,  $m_{\text{group}} = m_e$  and at sub-threshold we use  $Q$  ratios to emphasize wave nature ( $Q$  for quotient). To understand the PE effect without photons, visualize the pre-loaded state in the  $Q_{m/h}$  ratio. Energy loads up to threshold and an electron is emitted explosively (principle 2); thereafter, the charge-wave spreads classically.

The Compton effect is often claimed to require QM treatment. A classical treatment is in Compton

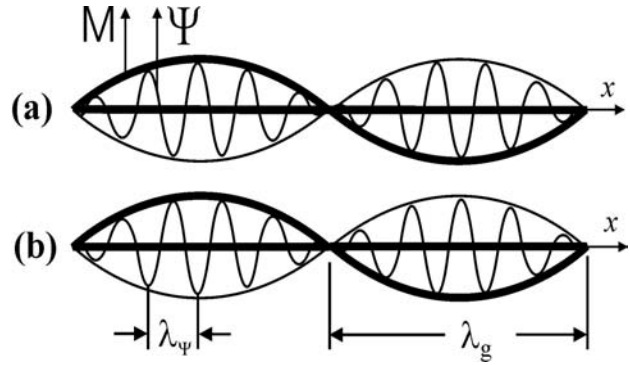

Fig. 9 Matter and antimatter. (a) Two positron beats. (b) Two electron beats.

and Allison's book,<sup>(13 pg. 232)</sup> but it modeled standing de Broglie waves of insufficient amplitude. If charge structures were inherently composed of beats of length  $d$ , it would naturally create the Bragg-grating required for the derivation. Use the Bragg diffraction equation  $\lambda_L = 2d \sin(\phi/2)$ , where  $\phi$  is deflection angle. Substitute for  $d$ ,  $\lambda_g$  from Eq. 5. Solve for  $v_g$  and insert into the Doppler shift equation  $\Delta\lambda_L/\lambda_L = (v_g/c) \sin(\phi/2)$ . Simplify using trig. identity  $\sin^2\theta = [1 - (\cos 2\theta)]/2$  and  $Q_{h/m}$  to yield  $\Delta\lambda_L = (Q_{h/m}/c)(1 - \cos \phi)$ , the Compton effect equation. Furthermore,<sup>(21)</sup> Bothe-Geiger's test of the Compton effect was not a one-to-one particle-like effect as often claimed; the coincidence rate was  $\sim 1/11$ .

What about quantized charge experiments? Measurements of  $e$  are performed upon ensembles of many atoms, such as in the Millikan oil drop experiment. It is an assumption of QM to apply  $e$  obtained this way, to the idea that free charge is always quantized. Charge, capable of spreading out as a wave with fixed  $e/m_e$  ratio for any unit of volume, loading up, and detected at threshold  $e$ , would remain consistent with observations. Furthermore, the electron need not be relatively small. Chemists performing *Electron Spin Resonance* measurements model the electron to be as large as the benzene ring. A QM electron predicts a smeared-out ESR spectrum.

Following is a list of famous experiments and principles re-analyzed with this developed Loading Theory (LT) by the author:<sup>(18)</sup> PE effect, Compton effect, shot noise, black body theory, spin, elementary charge quantization, charge & atom diffraction, uncertainty principle, exclusion principle, Bothe-Geiger experiment, Compton-Simon experiment, and the nature of antimatter as envisioned in **fig. 9**. The LT interprets these fundamental issues with ease.

Some LT concepts:<sup>(18)</sup> The envelope functions of **fig. 9** can be more shallow in the pre-loaded state; the envelope grows during resonant absorption. The envelope of  $\Psi$  is the identity of mass and charge. The maximum beat area at a given frequency is a threshold set by  $h$ . When matter and antimatter meet, the  $\Psi$  waves cancel, collapsing the coupling to light to form two  $\gamma$ . We still embrace probability, but we locate much of it in the undetectable level of a pre-loaded state at the absorber.

## Recent Tests of Others

Helium was diffracted in 1930-'32<sup>(42)</sup> but a 1999 *He* diffraction test<sup>(43)</sup> further elucidates the LT. *He* ions in a beam were sent through concentric circular Fresnel slits to a downstream scanning detector. The detection graph indicated both classical particle trajectories and wave interference patterns. This means that *He* can go across space in either of two states: as a wave or as a particle. This *two-states-of-matter* idea is not *wave-particle duality*.

Our evidence says, if an element can be expressed as a wave, the particle-concept reduces to a contained wave, a soliton. Loading happens in the soliton state. When fast or after an emission, the element can "cut loose" and show itself as a wave, because it is a wave.

There are tests in favor of QM that are not easily explained by the LT that require treatment here. Such tests are *Buckyball*<sup>(44)</sup> and dye molecule<sup>(45)</sup> diffraction, from the same lab in Vienna. We do not assume that such complicated molecules could load-up. Let us examine the dye molecule test. Their data can fit Eq. 2, but four striking anomalies have been identified:<sup>(46)</sup> (1) their fringes should have been blurred-out to twice as wide because there was insufficient velocity resolution in their apparatus; (2) fringe orders were twice as bright as they should be; (3) the molecules fall by gravity, and their difference in measured falls  $d_2 - d_1$  was shorter than expected by a factor of 3.4, where  $d = \frac{1}{2} g t^2 = \frac{1}{2}(\text{acceleration of gravity})(\text{distance particle travels/velocity})^2$ ; and (4) their movie-data reveals a visibly square-wave shaped fringe intensity profile that is characteristic of a shadow pattern. The obvious and strongest source of artifact, electric fields, were not addressed by the Vienna team. It is very reasonable that particles are casting mere shadow patterns that are magnified by static electric fields at the diffraction grating. Therefore, crucial control tests are required.

Another example of objectionable tests are those that employ pairs of emitted  $h\nu_L$  from parametric



down-conversion toward claimed success of quantum cryptography.<sup>(47†)</sup> There are thousands of  $h\nu_L$  pairs emitted, invalidating such claims. Society's investment in photons is so strong that the US patent office grants applications to quantum cryptography with no new physical evidence required from the inventor.<sup>(48)</sup>

Attempts to explain "wave properties of particles" have serious flaws. Consider the double-slit experiment with its wave pattern persisting at low count rates. In a pilot wave model, a particle would need to source the pilot wave, but the particle would not be properly guided because the strongest waves would go through the same slit as the particle. In a recent test employing silicone *walking droplets*,<sup>(49)</sup> waves were allowed to go over (not through) their slits, rendering an extrapolation of those results to the wave-particle problem void.

## Conclusion

The basic physical assumptions shown to fail are:

- light quantization and photons,
- quantized absorption for both matter and light,
- *particle-energy* conservation for both matter and light,
- the particle/probability-wave construct for both matter and light.

Each of those assumptions can be understood as an illusion, with associated phenomena explained by a contained matter-wave particle state, quantized emission, continuous absorption, and threshold/ratio properties of the matter-wave.

Fundamental questions are not easily resolved by experiment because there can be multiple interpretations of their workings and underlying theory. Fundamental questions are best resolved by consistency among many experiments with a conceptually consistent model. Physicists recognize this as a form of beauty.

Many great physicists have warned of inconsistencies within QM and the photon model. For example, in Lorentz's analysis,<sup>(1)</sup> he wrote "...the quantum of light concentrated in small space, and remaining undivided, is not in any way worthy of discussion." (translation)

The  $\gamma$ -split test can be constructed from components found in most physics departments. A low cost  $\alpha$  and  $\gamma$  test circuit could be developed. Software and other assistance is available on request.

## Acknowledgments

Ken Kitlas of Fremont CA graciously helped with many technical issues and equipment loans. After the author explained theory and proposed to perform a beam-split experiment in an untested part of the spectrum, Ken offered the idea to work with gamma-rays.

Mike Kan helped with many technical issues.

## References

1. H A Lorentz, Die hypothese der lichtquantin, *Physik. Zeitschrift*, vol. 11, pgs. 349-359 (1910).
2. T Marshall. [Crisis in Physics web page](#) .
3. N Bohr, *Atomic Physics and Human Knowledge*, pgs. 50-51, John Wiley and Sons Inc, New York (1958).
4. W Heisenberg, *The Physical Principles of the Quantum Theory*, pg. 39, Dover Publications Inc (1930).
5. M P Givens, An Experimental Study of the Quantum Nature of X-rays, *Philosophical Magazine*, vol. 37, pgs. 335-346 (1946).
6. E Brannen & H Ferguson, The Question of Correlation Between Photons in Coherent Light Rays, *Nature*, vol. 4531, pgs. 481-482, (1956).
7. J F Clauser, Experimental Distinction Between the Quantum and Classical Field Theoretic Predictions for the Photoelectric Effect, *Physical Review D*, vol. 9, pgs. 853-860(1974).
8. P Grainger, G Roger, A Aspect, A New Light on Single Photon Interferences, *Annals of the New York Academy of Sciences*, vol. 480, [pgs. 98-107](#), New York (1986).
9. P Lenard, On Cathode Rays, Nobel Lecture (1906); and *Annalen der Physik*, vol. 313, pg.149 (1902).
10. M Planck, Eine neue Strahlungshypothese (1911), *Physikalische Abhandlungen und Vorträge*, vol. 2, pgs. 249-259 (1958) [see eq. 14] Carl Schütte & Co, Berlin.
11. M Planck, *The Theory of Heat Radiation*, pg. 153, (1913) Dover, New York.
12. P Debye, A Sommerfeld, Theorie des Lichtelektrischen Effektes Vom Standpunkt des Wirkungsquantums, *Annalen Der Physik*, vol. 41, pgs.872-930 (1913) Leipzig.
13. A H Compton, S K Allison, *X-Rays in Theory and Experiment*, pg. 47 and pgs. 232-233, second ed. (1935) Macmillan.
14. R A Millikan, Electrons (+ and -), *Protons, Photons, Neutrons, Mesotrons, and Cosmic Rays*, revised edition, pg. 253 (1947) University of Chicago Press, Chicago.
15. T S Kuhn, *Black-Body Theory and the Quantum Discontinuity 1894-1912*, pgs. 235-264, (1978) Oxford University Press.
16. E Whittaker, *History of Theories of Aether and Electricity 1900-1926*, pg. 103 (1953).
17. N Bohr, H Kramers, J Slater, The Quantum Theory of Radiation, in *Sources of Quantum Mechanics*, B L Van Der Waerden, ed. pg. 165 (1967) Dover, New York; *Phil. Mag.* vol. 47, pg. 785 (1924); *Zeits. f. Phys.* vol. 24, pg. 69, (1924).
18. E S Reiter, [An Understanding of the Particle Property of Light and Charge](#) (2001) *viXra.org* 1203.0077.
19. *Photomultiplier Tubes Principles and Applications 1994*, pg. 2-8, Philips Photonics, Brive, France.
20. R D Evans, *The Atomic Nucleus*, [pg. 717](#) (1955).
21. E S Reiter, [Photon Violation Spectroscopy](#) (2005) *viXra.org* 1203.0094.
22. G Knoll, *Radiation Detection and Measurement*, pg. 693 (1979).
23. E S Reiter, [A Serious Challenge to Quantization](#) (2003) *viXra.org* 1203.0092.
24. E S Reiter, [Particle Violation Spectroscopy](#), fig. 7 (2007) *viXra.org* 1204.0032.
25. Ref. 21 fig. 11.
26. J J Kraushaar et al, Comparison of the Values of the Disintegration Constant of  $Be^7$  in  $Be$ ,  $BeO$ , and  $BeF_2$ , *Physical Review*, vol. 90, pgs. 610-614 (1953).
27. Ref. 21 figs.8, 9. 28. Ref. 21 fig. 12. 29. Ref. 21 fig. 13. 30. Ref. 21 fig. 18. 31. Ref. 21 figs. 14, 15, 16.
32. Ref. 24 figs. 2, 3.
33. Ref. 20 pg. 299.
34. P R Berman, *Atom Interferometry* (1997) Academic Press.
35. A Einstein, On a Heuristic Point of View Concerning the Production and Transformation of Light (title translated), *Annalen der Physik*, pgs. 132-148, vol. 17 (1905).
36. R Eisberg, *Fundamentals of Modern Physics*, pg. 79 (1961) Wiley.
37. No Time Lag in the Photoelectric Effect, *The Physics Teacher*, vol 48, pg. 285 (May 2010).
38. E O Lawrence, J W Beams, The Element of Time in the Photoelectric Effect, *Phys. Rev.* vol. 32, pg. 478,(1928).
39. E S Reiter, [Exposure of Physics Misconceptions](#).
40. L de Broglie, *An Introduction to the Study of Wave Mechanics*, pg. 3 (1930) E. P. Dutton and Company Inc, New York.
41. M Born, *Atomic Physics*, pg. 89, fifth edition, (1935) Hafner Publishing Company, New York.
42. I Estermann, R Frisch and O Stern, Monochromasierung der de Broglie-Wellen von Molekularstrahlen, *Zeitschrift fur Physik A*, vol. 73, pgs. 348 to 365 (1932).
43. R Doak et al, Toward Realization of an Atomic de Broglie Microscope: Helium Atom Focusing Using Fresnel Zone Plates, *Physical Review Letters*, vol. 83, Number 21, [pgs. 4229-4323](#) (1999).
44. O Nariz, M Arndt and A Zeilinger, Quantum Interference Experiments with Large Molecules, *American Journal of Physics*, vol. 71, issue 4, pgs. 319-325 (2003) American Association of Physics Teachers.
45. T Juffmann et al, Real-time Single-molecule Imaging of Quantum Interference, [Nature Nanotechnology](#), [pg. 297](#) (2012).
46. [Physforums discussion](#), and on <http://www.unquantum.net>.
47. T Scheild et al, [Violation of Local Realism with Freedom of Choice](#), *Proc.Nat. Acad Sci* (Nov. 1, 2010).
48. D Bethune et. al, Autocompensating quantum cryptographic key distribution splitting of light, US patent # 6,188,768 (Feb.13, 2001).
49. Y Coulder et. al, [Walking Droplets](#), *Europhysicsnews.org*, fig. 3.
50. [San Francisco Tesla Society lecture/demonstration 2003](#), and [Article in San Francisco Chronicle on Maker Faire 2007](#).