

God and His Creation: the Universe

A. Garcés Doz

February 26, 2012

angel1056510@gmail.com

Contents

1	Introduction	4
2	The principle of selection	4
2.0.1	The problem of digits or bits resolution of the parameters of the universe	5
2.1	The problem of the origin and characteristics of the algorithm that produces the selection of functions.	5
2.1.1	The problem of fundamental physical units.	6
2.2	The generalization of the mixture of states	7
2.3	The origin of the causality of the universe	8
2.4	God the great architect, physicist and mathematician	8
3	The different states of the vacuum	11
3.1	Vacuum of electromagnetic field	11
3.1.1	Maximum number of particles in the vacuum	11
3.1.2	Correction of the total particle count of applying the change of scale and the Heisenberg uncertainty principle	13
3.1.3	Number of lattice points of a sphere interpreted as the number of particles	14

3.1.4	Getting baryonic density of the universe Ω_b	15
3.1.5	Obtaining the vacuum energy density Ω_v	15
3.1.6	The state of the Higgs vacuum	22
3.1.7	Extraordinary properties of Table I	25
3.1.8	Relationship of the value of the Higgs mass with the density value Ω_v	31
3.1.9	Table states dependent sum of the groups $SU(n)$ with, n, number of Fibonacci divisor of 240 and the calculation of the boson mass Higgs lighter.	33
3.2	Mass of the neutrino and the mass equivalent to the minimum energy of the graviton	33
3.3	The cosmological vacuum	34
4	Calculation of dimensions 7D-spherical torus and its possible implications.	41
4.1	Principle of holography	44
4.2	11 dimensions Model	45
4.2.1	Observations of some relationships on the number of standard model particles	48
4.2.2	Number of particles of interaction and coupling angles.	49
4.3	The 26 dimensions and the Higgs vacuum	51
4.4	Spines, torus, colors and supersymmetry	56
4.4.1	The supersymmetry	56
4.4.2	The theorem coloration of orientable surfaces	57
4.4.3	Schematic of triangulation of the surface of a torus of genus 1 for the implementation of the theorem of colors.	64
4.4.4	Counting the number of particles in the vacuum by the triangulation of spins	65
4.4.5	Calculation of baryons antibaryons ratio to the number of photons	65
4.4.6	Calculation of the sum of modules of the spins of the 8-color triangles.	68
4.4.7	Unification scale supersymmetry	70
4.5	Particle in a spherically symmetric potential, the Higgs vacuum, the spins and the change of scale according to equation (11)	70

5	The origin of electric charge	72
5.1	Kissing number in 24 dimensions, the GUT unification scale and the Higgs boson	74
6	Cosmological consequences of theory	75
6.1	The Hubble constant: frequency of the cosmological vacuum energy	75
6.2	Creating energy by emptying the space-time to expand	76
7	Connecting the monster group, the superparticle, the Fibonacci numbers and the Higgs vacuum	78
7.0.1	The group M, the Fibonacci series and the symmetry of the vacuum	79
7.0.2	The group M and four-dimensional volume of the center of the torus of the superparticle.	81
7.1	The inflation: a natural consequence of the theory	82
8	The oscillatory phenomenon of radius π, the compactification of spheres in three dimensions and the vacuum Higgs	84
9	Geometric equations of state	88
10	Conclusión	90

Abstract

In this paper we demonstrate how the universe has to be caused or created by an intelligent being: God. And as the multiverse theory, mainly based on the random generation of states infinite universe is very poorly posed from the mathematical point of view, and how this failure leads to the demonstration of its impossibility. The anthropic principle called not taken into account, it is a mere philosophical statement without any physical-mathematical foundation, and therefore lacking the minimum necessary scientific validity. The main parameters are obtained: density of baryons, vacuum energy density, mass of the lightest Higgs boson, neutrino mass, mass of the graviton, among others. Deducting finally naturally within the theory, the inflation factor of the universe. Similarly, the theory implies necessarily the "creation" of matter

1 Introduction

The problem of the origin of the known universe is based primarily on its foundation, which is ignored by the main current theories: a) The theory of quantum fluctuation. b) generalization of the above: the theory of quantum fluctuation in a infinite number of states in which "test" the different initial parameters, mass, length, etc. to generate infinite bubble universes, the multiverse.

As mentioned, the main problem for the origin of the universe is the foundation that is obvious, namely: where and / or mathematical laws arise or algorithms that generate the functions which are based on physical laws we know ?

This is the main problem to solve that is separated by the main explanatory theories of origin, in itself, the universe.

The claim that mathematics is an invention of man leads immediately to the demonstration of its falseness: Since the universe is older than the existence of man, it can not have invented mathematics. Moreover, the mathematical principles underlying the universe are necessarily prior to its existence, as demonstrated.

A very different, is like the man approaches these mathematical relationships and tries to interpret and assimilate specific to your mind using tools developed by approximate or "invented" to understand these interconnected mathematical relations, theorems, axioms, etc., etc., existing.

In principle, we focus on the problem of what we call the principle of selection, to answer the end by the origin of mathematics, understood as properties, relations, theorems, axioms, etc. that are deducted for algorithmic logic properties of natural numbers, for it is well established and proven that the math we know is constructible by natural numbers and the limited knowledge of it, established by Godel's theorem and its equivalent (Turing, etc.)

2 The principle of selection

The principle of selection is that by which, using an algorithm or function unknown

was elected a function or finite number of functions that give rise to mathematical laws that underpin the physical reality within a transfinite set of possible functions, many of them, not algorithmically generated.

From the standpoint of general theory of quantum fluctuations, not answered this problem satisfactorily from a mathematical point of view.

The theory of the multiverse, so simplistic, says that an infinite number of different fluctuations give rise to different universes, bubble-go "testing" different parameters such as mass, length, etc, completely random. And that this probabilistic Ferris wheel of the "sum over histories" makes one of the universes where it is possible the existence of life.

2.0.1 The problem of digits or bits resolution of the parameters of the universe

Another question to be answered is what is the resolution of the numerical parameters in nature, ie:

The universal constant, dimensionless numbers and the main mathematical constants that are used as π , e , etc, do you have an infinite resolution digits (cases π , e), or there is a finite limit digits of resolution.?

Is there a dimensionless constant known or discovered to be a real number algorithmically not constructible or understandable?

2.1 The problem of the origin and characteristics of the algorithm that produces the selection of functions.

If you follow the argument of the theory of the multiverse, there is necessarily an existing program or algorithm that generates the universe completely random all possible features that may exist, since there is not an intelligent being who has "written" this program generator who choose to selectively or non-random. First serious opposition to the principle of cause and effect: the origin of the program.

Assuming the existence of the program generator with the above characteristics, derive the mathematical consequences.

- 1) It is known that the number of functions has a cardinal equal to the set of real numbers \aleph_0 , cardinal greater than the set of natural numbers or the set of sequential orders of a universal Turing machine.
- 2) A sequential algorithm or program type universal Turing machine needed to preserve the principle of cause and effect, a finite time of execution.
- 3) For point 1 it follows immediately that a program function generator type universal Turing machine can not generate all the possible functions. Moreover, and is a demonstration of the above statement, since there is a transfinite number of real numbers not understandable or not generated by any algorithm or function (as demonstrated Chaitin, among others); then you can build a function not generable, adding a real number not understandable, as a term of the same function. Since there are infinitely many real numbers are not understood, it immediately follows that it can generate infinite functions not understandable. At the most you can hope for is to know a finite number of bits of this number (to encode binary programs).
- 4) For point 2 since every program needs to run a finite time, and since the alleged program function generator must also always have a final stop order to give the final outputs or states of universes, bubbles, and since generated infinite states, the total runtime for all possible multiverses with cardinal equal to the set of natural numbers, is total runtime = ∞

5) Since the total runtime of the program random generator function is infinite, and infinite the number of universes, bubbles, the probability that exactly one of them is ours universe, is obviously: $\frac{1}{\infty} = 0$

6) If we add an ad-hoc assumption in support of the theory of the multiverse, in which

supported the existence of a random number generator computer program functions using quantum qbits, then the problem is further aggravated and becomes even more impossible.

7) An algorithm or program generator of this type would require an infinite amount of qbits while generating all possible constructible functions. This will solve the problem of infinite computational time step is generated in finite time all possible execution states generating functions of all possible infinite multiverse.

8) But this ad-hoc added complicates rather than solves, because a) so far has ignored a living "physical" the alleged algorithm generator and the need to have a memory for storing the generated states to increase their efficiency and not repeat function outputs or states already generated. But this statement implies an infinite amount of memory for no quantum algorithm, and also for the memory infinite quantum algorithm.

9) Where is located, which supports both infinite memory and the program itself?. A lot of memory space required for its existence?. A finite run time requires a finite length?. Necessarily this alleged program needs an existence of a prior state of a type of "universe", contrary to the view of the current theories that say nothing and the random fluctuations ignoring the origin of the mathematical laws that create these alleged fluctuations originated the multiverse and universe. The response that the program generates another program leads to an infinite sequence of retrograde same question, in short: an unsolved problem.

10) It is very doubtful, if not impossible for a problem without a solution either logically or algorithmically solvable can cause the universe.

Therefore the theory of multiverses and quantum fluctuations do not allow ignore the serious problems and contradictions that generate math and logic and are simply not possible.

2.1.1 The problem of fundamental physical units.

Another problem is apparently ignored by puerile theories of random fluctuations that gave rise to the universe from nothing, which has proved inconsistent with the need for a program random generator function, which requires the existence of a state of universe previously, the problem of measuring units of mass, time and length, which in combination generate the rest dimensional.

The problem is to respond to reference unit takes the presumed random quantum state that gives rise to the universe to the mass, time and length.

If there is nothing as yet has not caused the universe and there is no frame of reference of any existing mass, length and time, so how you set the unit of mass, time and length?

We believe that the only possible answer is that there must be some natural units of mass, time and length based on dimensionless numbers and that most likely are based on group theory and number of permutations and / or quantity of configurations associated states.

For example, I start from the following assumption: a) the maximum amount of longitudinal space would be a function of all possible permutations of 26 dimensions.

b) The maximum amount of mass produced at the beginning of the universe could be, for example, equal to the order of the largest sporadic simple group known, of the 26 that exist, ie the group called monster.

For maximum longitudinal space for the origin of the universe would have: $26! = 403291461126605635584000000$ natural length units

$$\begin{aligned} \text{Mass of the universe} &= \text{Order of the Monster group} = 2^{46} \cdot 3^{20} \cdot 5^9 \cdot 7^6 \cdot 11^2 \cdot 13^3 \cdot 17 \cdot 19 \cdot 23 \cdot 29 \cdot 31 \cdot 41 \cdot 47 \cdot 59 \cdot 71 = \\ &= 808,017,424,794,512,875,886,459,904,961,710 \end{aligned}$$

And the hypothetical density of the universe in natural units, it would:

$$\frac{2^{46} \cdot 3^{20} \cdot 5^9 \cdot 7^6 \cdot 11^2 \cdot 13^3 \cdot 17 \cdot 19 \cdot 23 \cdot 29 \cdot 31 \cdot 41 \cdot 47 \cdot 59 \cdot 71}{\frac{4\pi}{3} (26!)^3} = 2.9408646473684 \times 10^{-27}$$

Obvious that, surprisingly, this alleged natural mass density of the universe is about to real units chosen by the man, who for the mass is based on the amount of matter contained in one cubic decimetre of water, and the length one ten millionth of the meridian quadrant, in the international system.

Does this mean something is fortuitous coincidence?

Because what is more surprising: natural density / actual density = $\cos(\frac{2\pi}{5}) = \sin(\frac{2\pi}{20}) = \varphi^{-1}$

For the known number, dimensionless, the maximum number of electrons in the universe given by: $\frac{M_U}{m_e}$, where M_U = mass of the universe.

$$\frac{3H_0^2 \cdot (c/H_0)^3 \cdot (4\pi/3)}{8\pi G} = M_U$$

With a value for the inverse Hubble constant of $2.3 \times 10^{-18} s^{-1}$, we have an equivalent amount of electrons = $9.6083239721033 \times 10^{82} \cong \exp \sqrt{6} \cdot 60!$

Curious coincidence that seems to have a relationship with the total number of particles in the vacuum, which as demonstrated below, must be 120. If supersymmetry is inherent in the nature of the universe, we could reduce this number to 60.

2.2 The generalization of the mixture of states

In this section indicate, as will be shown later, as the mixture of states seems that nature extends to the mixing of states of dimensions, lengths dimensionless with respect to the Planck length, maximum number of Wrapped in hyperspheres in n dimensions, grid points in a metric space-time quantified.

One result is that the universe, it seems, a unique solution that corresponds to the sum of the hyper sphere from dimension 1 to ∞ , So that the mix of volumes as a result would give the characteristics of our space-time of 11 dimensions, 7 rolled into torus, 3 extended, and one of time.

This sum has a very approximate value of 44.9993, being the sum of the squares of the rectangular coordinates of a sphere of 7 dimensions, with $x_1 = \text{planck length O-ring 7-dimensional Kaluza-Klein type}$, $x_2 = \text{planck length black hole O-ring 7-dimensional Kaluza -Klein type}$, $x_3 = \text{length derived from the fine structure constant}$, $x_4 = x_5 = x_6 = x_7 = 2$; summation giving the value very close to 44.9992, as shown below.

This result completely invalidates the theory of the multiverse and clearly shows that precisely the amount of mixing of states paradoxically results in the uniqueness of the solution of the existence of a single universe.

The very small difference in the two above values seem to imply some ability of oscillation needed for a very slight asymmetry, but enough to trigger a major energy drain of vacuum tunneling or exponential form.

2.3 The origin of the causality of the universe

A universe with a source that is not possible for a random process from scratch, purely coincidental and that also shows one possible solution to fine tuning the initial parameters is only possible if an intelligent being created it.

A typical question and who created the creator or where it come from?, There is only one possible answer: God is the All.

And here is where you define as rigorously as possible can be understood by all.

In principle we refer to all, all mathematical truths existing or non demonstrable with a set of axioms finite. As Godel showed, for many axioms we add to the mathematics, there is always not decidable statements in this finite set of axioms, that is: there are infinitely many mathematical assertions whose decidability is unknown its value within a finite set of axioms, however large as this.

This would be a mathematical definition of all: this set of theorems, all true assertions of mathematics, regardless of their decidability in a finite human axiomatic.

Since this shown that there this set infinite theorems etc. or the Whole; What is origin or where emanates this All?. The answer: given by the same God in his holy word: "I am the Alpha and the Omega - says the Lord God - who is and who was and who is to come, the Almighty." (Revelation 1:8)

In summary: God is the All, the source of everything is the cause of everything. Therefore, ask that originated the whole is an absurd question, because by definition the whole can not be caused by anything else, it contains everything. God is the cause of all causes. The cause of God, is Himself.

2.4 God the great architect, physicist and mathematician

In the same way that a painter, architect, filmmaker, etc., leaves its mark or personal signature of his work, so impression that this feature is immediately recognizable to the creator of the work, is it possible that God, in his magnanimous love of man has

left a signature or imprint clear, precise and accurate?

The answer is :yes, and it is a mathematical answer.

As demonstrated the mathematical relationship is not possibly be due to chance, mainly because of probability and chance flatly impossible due to an intrinsic feature of this formula implies foreknowledge of the future.

From the top of this quantum mechanics has shown the similarity between the atomic model and the planetary system.

This is where the similarity signature, at least humbly found, the Creator.

For the search of this possible "signature"-relationship was based on the above principle of similarity, literally taken to extremes, so that the electron orbiting the nucleus represent the Earth and vice versa.

Since the force of gravity is interacting with all governing bodies and planetary motions, it was thought that the relationship would be of the gravity.

If indeed the universe has 8 extra dimensions, with a number of very special characteristics in relation to the structure of space-time, which will be shown later, it was thought that this factor may appear because of the similarity with the rule of 8 the last layer of electrons.

The mathematical relationship is:

$$\frac{8m_p^2}{m_{\oplus}(g)} = \frac{m_e \cdot G}{r_{\oplus}(e) \cdot c^2} a)$$

Where m_p =Planck mass; $m_{\oplus}(g)$ =Earth mass to the value of the gravitational acceleration ($g= 9.80665 \text{ m/s}^2$);

m_e =mass of the electron; $r_{\oplus}(e)$ =Earth's equatorial radius= 6378137 m; c =speed of light in vacuum.

$$G = 6.67428 \times 10^{-11} \text{ Nm}^2/\text{Kg}^2 \quad ; m_{\oplus}(g) = [9.80665 \text{ m/s}^2 \times (6378137 \text{ m})^2] / 6.67428 \times 10^{-11} \text{ Nm}^2/\text{Kg}^2 = 5.977284 \times 10^{24} \text{ Kg}$$

And using the value of the mass of the Earth to the value of the gravitational acceleration, according to the equality of a), we have a value for the Planck mass:

$$8m_p^2 = \frac{m_{\oplus}(g) \cdot m_e \cdot G}{r_{\oplus}(e) \cdot c^2} b)$$

By chance it is impossible for the former relationship is casual, since the possible combinations of mass and length ranges of the universe, make it impossible.

And last but not least, it is even more unlikely that using the Earth's mass extracted from the value of g , ad-hoc value, it depends on the local latitude, see this related to the degree of accuracy displayed.

It is shocking that this value of g was chosen by man as a particular latitude, and this relationship exists before man existed.

Only God and his foreknowledge of the future knowledge can perform this wonder of "signature"

As mentioned, the number 8 plays a role in the mathematical structure of a unified theory and has a unique relational characteristics.

1) The sum of the permutations of the prime number dimensions that are less than or equal to 3, $8 = 3! + 2!$

2) $8 = 2^3 = \dim[SU(3)]$ =repetition number of variations of 2 items taken 3 to 3.

We see that this number coincides with the construction of 8 torus in 3 dimensions since for x, y , and forming all possible variations with repetition, imposing that one dimension is folded over itself in a circle, is equivalent to the following algebraic series: $x^2y, xyx; yx^2; xy^2; yxy; y^2x; x^3; y^3$

3) When using the 3-dimensional x, y, z ; imposing again that one of them double back on itself in a circle, you get 21 torus with the following algebraic series, 3 of whom topological surgery have become spheres: $x^2y; xyx; yx^2; x^2z; xzx; zx^2; y^2x; yxy; xy^2; y^2z;$

$yzx; zyx; z^2x; xz^2; z^2y; zyz; yz^2; x^3; y^3; z^3$

$21 = \dim[SO(7)]$

4) If the previous series, given in 3), remove the items permuted, we obtain 9 torus, equal to the amount obtained by point 3)

5) The number 8 is the only one who owns the property such that $2^n = n^2 - 1 = \dim[SU(n)]$ and that in turn is the sum of the prime dimensions permutations of less than or equal to n , besides being the generator of the exceptional Lie group E8, using the maximum amount of 8 dimensional spheres touch each other and a central, which is 240, equal to the amount of generating nonzero roots of the group E8, which contains the 4 remaining exceptional Lie groups.

6) $8 + 3 = 11$ dimensions, $8 \times 3 = 24 = \dim[SU(5)] = 4!$ =permutations of 4 dimensions

7) 24 in turn is the only number for which the quadratic equality checks 24 dimensions: $\sum_{n=1}^{24} n^2 = 70^2$

Later we will appreciate the importance of number 70 to calculate the vacuum energy.

Of all the above it follows that the number of dimensions of the universe is a mixture of states by the application of 3-dimensional operations under items 2), 3) and 4). In later sections these results are more pointed.

Note that this coincides with the following mixture of dimensions: $1 + 2 + 3 + 4 = 10$

And the average for a sum of mixed rolled states of 7 dimensions:

$$(1 + 2 + 3 + 4 + 5 + 6 + 7)/7 = 4$$

3 The different states of the vacuum

Quantum mechanics shows how the vacuum changes its state, not only in terms of real particles that interact with, but also as there are several different types of transition states of the vacuum.

These transition states would be mainly: a) The vacuum state of minimum energy, correspond to the cosmological vacuum derived from the GR.

b) Moving up the value of energy, there would be a vacuum due to the electromagnetic field, dependent on the charged particles and exchange of bosons, photons.

c) The vacuum Higgs field appears as the third step of energy.

d) The vacuum at the GUT scale theories.

e) And finally: the vacuum state to the Planck scale.

3.1 Vacuum of electromagnetic field

In this paper we will focus primarily on the electromagnetic vacuum, the minimum energy, or cosmological and the Higgs vacuum.

It is considered the minimum energy state for the vacuum due to the interaction with electric charges and photons, such as those in which the value of the rest mass of the charged particle is the smallest possible, and also the particle in the vacuum does not have the possibility of decay to a lower-mass is not zero.

This vacuum state corresponds to electron not virtual particle completely stable and not decay into other particles with nonzero mass in a state of no interaction.

3.1.1 Maximum number of particles in the vacuum

It is well known that a virtual photon with sufficient energy can produce a particle-antiparticle pair. Likewise, a couple of real photons with sufficient energy can produce a real pair particle-antiparticle.

Conversely occurs with a virtual particle-antiparticle pair, which can be a photon or two photons to a real particle-antiparticle pair.

The fine structure constant energy level 0 ; Can be considered as the probability that an electron emits or absorbs a photon. In this way with a number of electrons:

$$n(e^-, \alpha^{-1}) = \alpha^{-1} \quad (1)$$

And the probability P emission or absorption for this amount of electrons is 1

$$P(n(e^-, \alpha^{-1}) \longrightarrow 1\gamma) = 1 \quad (2)$$

However, the above process is equivalent also to all possible pairs of real and virtual electrons such that:

$$virtual \left\{ \begin{array}{l} e^- + e^+ \rightarrow \gamma \\ e^- + e^+ \rightarrow \gamma \end{array} \right. \equiv real \left\{ e^- + e^+ \rightarrow 2\gamma \right. \quad (3)$$

Therefore by (1), (2) and (3), we have that the actual maximum number of electrons in this ideal state where there are only electrons and photons (minimum energy state) is:

$$n_r(e^-) = \alpha^{-1} - \frac{\alpha^{-1}}{4} \quad (4)$$

Soon we will show that this apparent extravagant way of counting, it is precisely the one that shows the reality of nature.

Since in this idealized state of minimum energy vacuum, where there are only electrons and photons have been counting the number of electrons needed to count the photons and add the result to get the maximum number of particles for this state minimum energy.

Immediately follows by (3), for the actual pairs of photons:

$$n_r(\gamma) = \alpha^{-1} \quad (5)$$

And the total number of pairs of particles:

$$S_{n_t} = 2\alpha^{-1} - \frac{\alpha^{-1}}{4} = 239.812998397 \quad (6)$$

$$239.812998397 \approx 240 = \zeta^{-1}(-7) \quad (7)$$

It is considered important to note that $240 = \zeta^{-1}(-7)$, this number is the factor in the formula Cassimir effect due to the vacuum electromagnetic as well as the maximum number of hyperspheres that touch each other and a central in 8-dimensional space.

This seems to point to (6), except for a slight asymmetry, the possible maximum number of particles would be 120, and that (6) recounts the total number of pairs.

3.1.2 Correction of the total particle count of applying the change of scale and the Heisenberg uncertainty principle

The Heisenberg uncertainty principle states that:

$$\Delta x \Delta p \geq \frac{\hbar}{2} \quad (8)$$

If we consider a scale change x_1, x_2, p_1, p_2 $x_1 > x_2$; by simple algebraic manipulation yields the following equation, considering the minimum limit of uncertainty given by the factor 2:

$$2\left(\frac{\Delta x_1}{\Delta x_2}\right) = 2\left(\frac{\Delta p_2}{\Delta p_1}\right) = 2\left(\frac{\Delta m_2}{\Delta m_1}\right) \quad (9)$$

Being m_2, m_1 , the respective masses of the particles, whether real or virtual.

If there is an infinite number of particles would exist an infinite number of jumps of scale given by (9). This would imply the existence of infinite energy and therefore the appearance of infinite quantities in the calculations, as is currently the unsatisfactory, although very efficient use of ad hoc method of renormalization.

For this reason we think that space-time has to be quantified with a minimum scale length. The minimum scale length should be the Planck scale.

If this minimum length is defined as:

$$\sqrt{\frac{\hbar G_N}{c^3}} = l_p = l_0 \quad (10)$$

Thus, if we consider a length l_1 , and its uncertainty Δl_1 interpreted as a differential and considering particle-antiparticle pairs, or two real pairs of particles produced by two photons of sufficient energy, it must be for the amount of particles with respect to the minimum length scale of Planck:

$$\Delta l_1 = dl, l_0 = l_p, n(p) = \text{number of pairs} \quad \frac{2dl}{l_0} = \frac{2dl}{l} = 2 \cdot dn(p)$$

$$2 \cdot \int_{l_0}^{l_1} \frac{dl}{l} = 2 \cdot \int dn(p) \quad 2 \cdot n(p) = 2 \left| \ln \left(\frac{l_1}{l_0} \right) \right| = 2 \ln \left(\frac{m_p}{m_1} \right) \quad (11)$$

Being m_p the Planck mass. Using (11) we have that the maximum number of pairs

$$\text{for the electron in the lowest energy state of vacuum is: } 2 \ln \left(\frac{m_p}{m_e} \right) = 2np(e^-)$$

Thus the maximum number of particles to the vacuum state of minimum energy, and using the previous result by (6) and (5), with the most accurate known values of universal constants:

$$Sn_t = 2 \ln \left(\frac{m_p}{m_e} \right) + (n_r(\gamma) = \alpha^{-1}) = 240.09168122877 \quad (12)$$

$$2 \ln \left(\frac{m_p}{m_e} \right) = 103.05568214477$$

$$\alpha^{-1} = 137.035999084$$

We believe that the value obtained by (12), as close to 240, which is the amount of non-zero roots in the representation of E8 group, and likewise the maximum number of hyperspheres that can be packed in a minimum volume 8 dimensional mutually related is not merely a numerological coincidence graceful, if not to the contrary, shows that there must be a theory of strings quite possibly combined perhaps with the loop quantum theory based on the symmetry group E8. Recalling that one can construct the (compact form of the) E8 group as the automorphism group of the corresponding E8 Lie algebra. This algebra has a 120-dimensional subalgebra SO(16).

3.1.3 Number of lattice points of a sphere interpreted as the number of particles

The outcome obtained by (11), $2 \left| \ln \left(\frac{l_1}{l_0} \right) \right| = 2 \ln \left(\frac{m_p}{m_1} \right)$ directly implies that $2 \ln \left(\frac{l_1}{l_0} \right) = \ln \left(\frac{l_1^2}{l_0^2} \right)$ and $2 \ln \left(\frac{m_p}{m_1} \right) = \ln \left(\frac{m_p^2}{m_1^2} \right)$

Considering the spherical wave emission. can interpret the above equalities as amount of lattice points of the surface of a sphere, so that for the electromagnetic field value and its associated photons waves, one would have a dimensionless radius in relation to the length of planck of a value given by:

$$\alpha^{-1} = 4\pi r^2(\alpha^{-1}) \text{ and this radius is: } r = \sqrt{\frac{\alpha^{-1}}{4\pi}} = 3.30226866228015 \quad (13)$$

Is to be noted as this value seems to indicate a fractal value for the dimension 3

3.1.4 Getting baryonic density of the universe Ω_b

The asymmetry between the exact value of 240 and obtained by the formula (12), I mean the difference: $240.09168122877 - 240$; To be a difference between amounts of particle-antiparticle pairs and be less than unity, must correspond to the remainder of this annihilation, which leaves not being symmetric baryonic density. Therefore, the density of baryons in the universe must be: $(240.09168122877 - 240)/2 = 0.045840614385 = \Omega_b$ (14) , value very close match with the experimental cosmological value and taking into account the current values of the constants used.

Automatically we can say that the amount of empty particles are 120 and if the theory of supersymmetry is correct, $120/2 = 60$ would be the amount of s-particles and vice versa.

Therefore a unified theory based on dimensional group E8 and 11 is the most plausible candidate.

3.1.5 Obtaining the vacuum energy density Ω_v

Before presenting the derivation of the calculation is necessary to define the structure of spacetime and the role of the 5 exceptional Lie groups.

3.1.5.1 Framework of spacetime As discussed in the beginning, we will build on the principle of simplicity, referring to the extra dimensions are generated by mixing of states of the 3 spatial dimensions and one temporal.

At first he showed how you can get 8 torus through an internal operation of the 3 dimensions are not curled, which as you can see, is isomorphic to the mix of possible helicity states for a photon states as a mixture of 3-dimensional, isomorphic to turn to 8 states quantum of mixture of 3 qbits.

Consider this method:

$$8 = 2^3 = \dim[SU(3)] = \text{number of variations with repetition of 2 items taken 3 to 3.}$$

We see that this number agrees with the construction of 8 torus in 3 dimensions, since for x, y, and forming all possible variations with repetition; imposing that one dimension is turned on itself in a circle, is equivalent to algebraic series following:

$$x^2y, xyx; yx^2; xy^2; yxy; y^2x; xyz; yxz$$

$$\text{Likewise } 8 = \sum_{n=1}^8 n^2$$

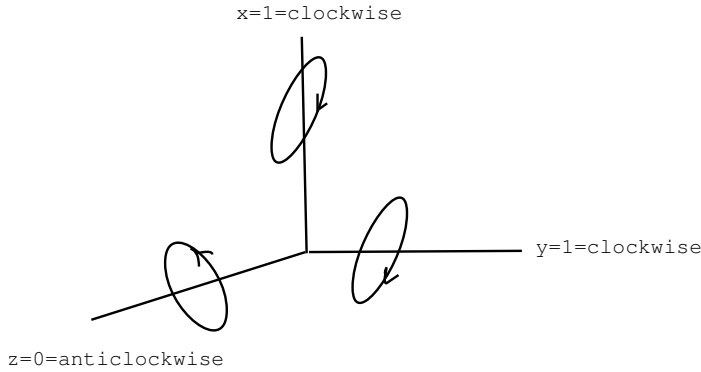

String theory was based at first on a theory of 26 dimensions. Let's go weaving a series of connections that lead us to believe that indeed these 26 dimensions are somehow acting in the background as part of mixed states and generator size, 26, of the 5 exceptional Lie groups.

- a) The sum of the dimensions smaller or equal to 3: $3 + 2 + 1 = 3!$; and the sum of its permutations: $3! + 2! = 8$; $3! + 2! + 1! = 3^2$
- b) Special case: $2^3 = 3^2 - 1$
- c) Prime spherical coordinates with dimensions 2 and 3: $2^2 + 3^2 = 26/2$
- d) If at 8 torus obtained by the series $x^2y, xyx ; yx^2 ; xy^2 ; yxy ; y^2x ; xyz ; yxz$ we change them by the isomorphous series when replacing the values of the coordinates, x, y, by states 1,0; representative turn of the helicities of the states aforementioned mixture of photons, one obtains the series: 110, 101, 011, 100.010, 001, 111, 000 ; all, a symmetric amount of quantity of dimensions with bit 1 of 12, and another 12 with bit 0, ie: 24 dimensions, isomorphic to the amount of permutations-dimensional mixture of 4 dimensions.

The twenty-six dimensions are a function of the number of torus states . With three dimensions are obtained, 9 torus volumes, and with 2 dimensions, 4 torus surfaces. These states take negative and positive values for the dimensions that roll, which allows the generation of twenty-six states-dimensions. The states are summarized in this way:

3 dimensions : $x^2y, x^2z ; y^2x, y^2z, z^2x, z^2y, x^3, y^3, z^3$ Volume torus : $2\pi^2 Rr^2$

$(-x)^2y, (-x)^2z ; (-y)^2x, (-y)^2z, (-z)^2x, (-z)^2y, (-x)^2x, (-y)^2y, (-z)^2z$

2 dimensions : xy, yx, xx, yy Torus surface : $4\pi^2 Rr$

$-x - y, -y - x, -x - x, -y - y$

- e) Taking the arithmetic mean of the mixture of the dimensions with a value 1 (referred Planck length so it) and is counted as a state more, you get 13 dimensions. The same can be done to the dimensions with bit 0, and get another 13 . If you add up all the states obtained for bit 1 and 0 dimensions, have or will generate 26 dimensions: $26 = 3^3 - 1$

The total amount of energy density would be the matrix product of $2^3 \cdot 2 \cdot \Omega_b$; since the amount of possible interactions is the product of pairs 2^3 ; states representing the helicities of the states mixture of photons before mentioned by the series: (110, 101, 011, 100, 010, 001, 111, 000)

But considering that the density of baryons can be part of the generated states, 2^3 , then it would have finally:

$$\Omega_v = (2^3 - 2 \cdot \Omega_b)2 \cdot \Omega_b \quad (15)$$

The calculation gives the value of: $\Omega_v = (8 - 2 \cdot 0.045840614385)2 \cdot 0.045840614385 = 0.725044382451$.Value in total agreement with the experimental cosmological value.

As seen, the asymmetric density given by (14) is the sum of the contributions of the densities for the electrons plus the photons, subtracting the integer parts 103, 137; which are also number of pairs and two primes, indicating quantum entanglement, as being prime numbers, these probabilities (inverse) can not be the product of other odds whole. And still more interesting is to note that both numbers belong to a couple of pairs of twin primes: (101, 103) ; (137; 139). It thus appears that the prime numbers play some role, perhaps in quantum entanglement, because again, the number 240 is right in the middle of another pair of twin primes: (239, 240, 241)

Strengthens this idea of the connection of quantum entanglement, the fact that precisely the group E8, derive a density of packaging of spheres which touch each other and a central, 241 (prime number) of 240 spheres in dimension 8D. 241 Spheres touch each other, implies some kind of geometric-topological property so instantly transmissible by total mutual connectivity. By way of a mesh of connected points, which after suffering a deformation in one of its points, is reflected automatically in all other general or local. This could be the source of the explanation of the effect called quantum entanglement ghost.

Too many coincidences to be fortuitous if one adds the detail that for the pair (101, 103); 101 is precisely the 26 prime number and also: $101 = 10^2 + 1$

Generation of the dimensions of the 5 exceptional groups of Lie These dimensions can be generated with the following series:

$$\dim(G2) = 13 \cdot 1! + 1 \quad ; \dim(F4) = 2 \cdot 2! \cdot 13 \quad ; \dim(E6) = 3! \cdot 13 \quad ; \dim(E7) = 5! + 13$$

$$\dim(E8) = (8! + \sum_{n=1}^6 F_n^2) / 163 \quad ; F_n = \text{Fibonacci number}$$

1) Group G2: Note that for G2, the group of smaller dimension: G2, $\dim(G2) = 1^2 + 2^2 + 3^2$; the vector sum of the dimensions 1, 2 and 3.

2) The sum of the terms numerical factorials: $1 + 2 + 3 + 5 = 11$; $1^2 + 2^2 + 3^2 + 5^2 = 3 \cdot 13$; $5^2 - 3^2 - 2^2 - 1^2 = 11$; and $1 \cdot 2 \cdot 3 \cdot 5 = 30$; $30 \cdot 8 = 240$; $8 = 1^2 + 1^2 + 1^2 + 1^2 + 1^2 + 1^2 + 1^2 + 1^2$

Note that 1, 2, 3, and 5 are numbers followed by the Fibonacci series and divisors of 240.

With the important numeric property, as will be shown later that:

$$1^2 + 2^2 + 3^2 + 5^2 = 39 = \dim(E6)/2 \quad ; 1 + 2 + 3 + 5 = 11 \quad ; \dim[SU(11)] = 240/2$$

$$\exp(39 \cdot \pi/2) \cong 26! \quad ; \exp(39/\pi) + \sqrt{-\sin(\pi^2/2)} \exp \exp([(l_p(26D) + R_H(26D))/2 - 6]^{-1}) = m_H/m_e$$

Higgs boson mass lighter = m_H

- Since the possible values of the spins, imposed by the maximum amount of supercharges (32 supercharges): 0, 1/2, 1, 3/2 and 2; the sum of projections for all the spins in a hypothetical mixture of states, would be:

$$\sum_s 2s + 1 = 15$$

If this sum we generalize and symmetric for all non-extended dimensions, including time, we have:

$$8 \left(\sum_s 2s + 1 \right) = 120 \quad (16)$$

$\sum_s 2s + 1 = 15 = \dim[SU(4)] = \dim[SO(6)]$. These equations seem to indicate that the generaci3n of this mixture of states of the projections of the spins should be related to a generation by an array of Higgs bosons ι_4 ?

The reduction of 26 dimensions to 11 would be by interaction with this matrix SU(4); so that $26 - 15 = 11$

$15 = 8 \text{ gluons} + 3 \text{ weak bosons } (w^+ w^- z) + 1 \text{ photon} + 2 \text{ Higgs bosons} + \text{vacuum Higgs}$; or other particle to be discovered.

For all the above features and their direct connection with the group SO(7), the group G2, being the smallest (hierarchical principle of simplicity) seems the most appropriate as the beginning of a thorough investigation of their relationships with physical particles and possibly some empty states.

F4 Group: This group in turn has its fundamental representation $2 \cdot 13$ dimensions and has rank 4.

E6 Group: This group E8 breaks down as $SU(3) \times E6 = 8 + 78 + 162$. Its fundamental representation has dimension $27 = 26 + 1 = 3^3$. Their number of dimensions is equal to the dimensions of the rotation group of 13 dimensions: $\dim(E6) = \dim[SO(13)]$

His unequivocal connection with numbers followed by the Fibonacci series, divisors of 240 ($240 = 1 \cdot 1 \cdot 2 \cdot 3 \cdot 5 \cdot 8$), is reflected by the amount of mixing of states of the following series:

Table I

1^2
$1^2 + 2^2 = 5$
$1^2 + 2^2 + 3^2 = 14$
$1^2 + 2^2 + 3^2 + 5^2 = 39$
$1^2 + 2^2 + 3^2 + 5^2 + 8^2 = 103$
$\sum = 162$

And $240 = 162 + 78$; which clearly demonstrates a direct relationship of the numbers of Fibonacci dividers 240 and the E6 group, and therefore a direct relationship with the structure of spacetime and the vacuum.

Given, moreover, that these fibonacci numbers, dividers 240, produce the generators groups of the boson-exchange standard model particles, such that: $dim[U(1)] = 1$; $dim[SU(2)] = 2^2 - 1$; $dim[SU(3)] = 3^2 - 1$; $dim[SU(5)] = 5^2 - 1$; be $SU(8)$, a group which can be decomposed as: $dim[SU(8)] = dim[SU(7)] + dim[SU(4)] = 63 = 21 \times 3 = dim[SO(7)] \times dim[SO(3)]$

In this way, and with a Higgs boson in generating not only the mass, if no energy exchange of bosons, then the table I could be transformed as:

Table I.1

$1^2 = 0 + 1H$
$1^2 + 2^2 = 5 = 0 + 1H + (2^2 - 1) + 1H$
$1^2 + 2^2 + 3^2 = 14 = 0 + 1H + (2^2 - 1) + 1H + (3^2 - 1) + 1H$
$1^2 + 2^2 + 3^2 + 5^2 = 39 = 0 + 1H + (2^2 - 1) + 1H + (3^2 - 1) + 1H + (5^2 - 1) + 1H$
$1^2 + 2^2 + 3^2 + 5^2 + 8^2 = 103 = 0 + 1H + (2^2 - 1) + 1H + (3^2 - 1) + 1H + (5^2 - 1) + 1H + (8^2 - 1) + 1H$

Characteristics of Table I.1 This table is composed of a sum of consecutive mix of states, as the sum of the boson-exchange states $U(1)$, $SU(2)$, $SU(3)$, $SU(5)$, $SU(8)$; plus a Higgs boson (H) which gives the mass / energy for each group of bosons.

The first 3 rows of the table has a direct relationship to the Higgs vacuum and the value of the cosmological vacuum, as shown later.

1^2
$1^2 + 2^2 = 5$
$1^2 + 2^2 + 3^2 = 14$

These rows have the distinction of locking in themselves, the 3 spatial dimensions.

With it generates the rest of the table. And the value of the product of the sum of the three states of each row, seems to contain the values of the Higgs vacuum and the cosmological in relation to the Planck mass by the formula (11): $5 \cdot 14 = 70 = \sqrt{\sum_{n=1}^{24} n^2}$; $5 \cdot 14 = 5 \cdot 2 \cdot 7$; $5 + 2 + 7 = \dim(G2)$

As will be shown below: $[\ln(m_P/m_v)] = 70$, where m_v is the mass corresponding to the value of the cosmological vacuum energy.

$5^2 + 2^2 + 7^2 = 2 [\ln(m_P/m_H)] = \dim(E6)$; where m_H is the mass of neutral Higgs boson lighter.

The table generation can be performed with dimension 2, or 2 bits, two states.

$$2^0 = 1 , 2^1 = 2 , 2^2 \pm 1 = 5 , 3 ; 2^3 = 8$$

Likewise the spins can be generated with the following series derived from previous:

$$\frac{2^0}{2} , \frac{2^1}{2} , \frac{2^2}{2} , \frac{2^2-1}{2} , \text{ be satisfied that: } \frac{2^0}{2} + \frac{2^1}{2} + \frac{2^2}{2} + \frac{2^2-1}{2} = 2^2 + 1$$

$$\text{The spin 0: } \frac{2^0}{2} + \frac{2^1}{2} + \frac{2^2}{2} + \frac{2^2-1}{2} - (2^2 + 1) = 0$$

As previously showed, the amount of mixture of all projections of the spins:

$$\sum_s 2s + 1 = 15 = 1^2 + 1^2 + 2^2 + 3^2 ; \text{the first 4 numbers of the Fibonacci series, dividers 240 and that satisfies: } 240/1 \cdot 1 \cdot 2 \cdot 3 = 40 = K(5D) ; \text{ being the dimensional sum: } 1 + 1 + 2 + 3 = 7$$

This way of generating the spins does not seem merely a hobby mathematician or happy coincidence, because:

$\sin[2\pi / \sum_s \sqrt{s \cdot (s+1)}] \cong \varphi/2$; where φ is the limit of two consecutive terms of the infinite series of Fibonacci numbers:

$$\varphi = \frac{1}{2} + \frac{\sqrt{2^2+1}}{2}$$

5 states are mixed with 15 quadratic elements as a sum of spherical coordinates or vector sums, equal in number to the number of Higgs bosons repeated by group of bosons, which points to a group $SU(4)$,generated by the array of 4 Higgs bosons. $15 = \dim[SU(4)]$.

The sum of all numbers in each group generators for the sum-total state table is:

$$1 + (1 + 2) + (1 + 2 + 3) + (1 + 2 + 3 + 5) + (1 + 2 + 3 + 5 + 8) = 39 + 1 = 40$$

The group $SU(5)$ with dimension 24 represents the 24 known elementary particles and is an "isomorphism" or equivalent to paragraph that has developed in Section 3.1.5.1

It would be isomorphic to a hypothetical group of bosons m_X

But as shown in this paragraph, in 4 dimensions, be wanting, if the schema is correct, another 2 particles and that these characteristics have been obtained as an arithmetic mean of the mixture of 12 and 12 dimensions for bit states 1 and 0, leads us to think that one of them, or both, must be Higgs bosons.

Looking at the fifth column of the previous series: $1^2 + 2^2 + 3^2 + 5^2 + 8^2 = 103$; appears the whole: $2 \ln(m_p/m_e)$; and as the sum of vector coordinates of a sphere, which confirms the structure of lattice points on spheres and their equivalence to the amount of particles by changing the scale in relation to the final scale of Planck, or fundamental, sum equivalent to coordinate dimensions.

Consider some other clear examples of the possibilities of partitions of 240, to obtain some good approximations to some essential particle masses.

1 The decomposition of $240 = 162 + 78$, being obtained the number 162 by the table view, in which the last column was $\left[2 \ln(m_p/m_e) \right]$; would indicate that 162 has to be related with the scale of electron mass as reference, so as to represent quantity of particles of the vacuum, has to be a logarithmic form by the change of scale given by the formula (11).

To clarify this logarithmic form we look at the other member is identified quickly as $\left[2 \ln(m_p/m_Z) \right]$ Exactly the decomposition of 240 is given, as is known, by: $E6 \times SU(3) - 8 = 8 + (3, 27) + (\bar{3}, \bar{27}) + 78 - 8 = 81 + 81 + 78 = 240$

It has broken the vacuum, the amount of particle-antiparticle pairs in 3 parts, 2 of them equal, 81×2 ; and $\dim(E6) = 78$

Combinations are now generalized to 3 dimensions, to include its permutations, combinations of dimension 2: spherical surfaces (or torus open and unrolled), toric surfaces, and finally, combinations of dimension 1.

This will get the following final tables:

Table II

x^2y	xyx	yx^2
y^2x	xyy	xy^2
x^2z	xzx	zx^2
z^2x	zxx	xz^2
z^2y	zyz	yz^2
y^2z	yzx	zy^2
xyz	zyx	yxz

Table III

Permutations of 3 dimensions:

xyz
yxz
zyx
zxy
xzy
yzx

Table IV combinations in 2 dimensions:

xy	xz	yz
yx	zx	zy
x^2	y^2	z^2

Table V combinations in 1 dimension:

x	y	z
-----	-----	-----

It is then that for three-dimensional states, the total particle states is equivalent to: $27 = \dim[SO(7)] + \dim[SO(4)] = \dim[SO(7)] + 3!$

If we multiply this sum by the group of rotations in 4 dimensions, we obtain the

number 162, obtained by mixing states of the square sum of the divisors of Fibonacci numbers, the total particle-antiparticle pairs of vacuum, 240, equal to the Kissing number in 8D : $(\dim[SO(7)] + 3!) \times \dim[SO(4)] = 162$

If you perform the sum of states, ie states sum of dimension 3, dimension 2 and dimension 1, of the above tables, we obtain: $S(3D) + S(2D) + S(1D) = 39$ (17)

If this many-particle states, we add their antiparticles, or add the time variable, we obtain a total mixing of states such that: $2 \times [S(3D) + S(2D) + S(1D)] = \dim(E6) = 78$

3.1.6 The state of the Higgs vacuum

In the previous sections has proven to be a vacuum, the amount of particle-antiparticle pairs, is decomposed by simple operations, with the 3 dimensions are not curled, and generate the states and their equivalence to the partition $E6 \times SU(3)$; well as its relationship with the states mix of the sum of the squares of the divisors of 240, all of them, the first 5 numbers of the Fibonacci series.

Focusing on Table I and its complementarity with the E6 group, to obtain 240;

you get to the partition of particles: $81 + 81 + 78 = 240 = (39 + 1) \times 6$

Looking at the table and, it appears that rows 3 and 4, have the respective values of 14 and 39, that is: $14 = \dim(G2)$;y $39 = S(3D) + S(2D) + S(1D) = \dim(E6)/2$

Precisely the sum of states for the Fibonacci number 5, for which: $dim[SU(5)] = 24 = 12 \times 2 = 24 = Kissing\ number(4D)$

If the vacuum state given by the partition resulting from $E6 \times SU(3) \rightarrow 81+81+78 = 240$; is a literal and accurate representation of most probable modes of disintegration of the Higgs vacuum in the energy region 4 dimensional, or of the particles of standar model, through its bosons with nonzero mass highest; then you should have this equivalence:

Table VI $H = Higgs$

81	81	78
$H H$	W^+W^-	ZZ
$2\gamma\ b\bar{b}$	$l\nu l\nu$	$4l$

The sum of particles given by tables II-V, $S(3D) + S(2D) + S(1D)$; you just have to add

the state of dimension 0, or the time, so that: $S(3D) + S(2D) + S(1D) + S(t = 0D) = 40 = 8 \times 5$; or the product of the last 2 Fibonacci numbers dividers $240 = K(8D)$; where $K(nD)$, symbolize the n-dimensional Kissing number. Note that: $S(3D) + S(2D) + S(1D) + S(t = 0D) = 40 = K(5D)$; and $K(8D) = 240 = K(5D) \times K(2D) = K(7D) + K(6D) + K(4D) + K(3D) + K(2D) = 126 + 72 + 24 + 12 + 6$

No wonder that $K(8D) = 240 = K(5D) \times K(2D)$; , given its more than likely related to the maximum number of spins, 5 (0, 1/2, 1, 3/2, 2) ; and the essential role of these for the property: $5! = dim[SU(11)]$

Equivalence with the amount of Standard Model particles and K (5D) If recount the total amount known elementary particles have that:

6 quarks x 3 colors = 18

6 leptons = electron, muon, tau, electron neutrino, muon neutrino and neutrino tau.

8 gluons

3 electroweak bosons

1 photon.

Fulfilled that for the electric charge, their sum is 0, or neutral.

In total: $36 = 6^2$; particles. Be missing, according to this scheme theorized other 2^2 ; maybe Higgs bosons could be 2 and 2 s-higgs partners. These 40 particles is the count of the sum of generators of Table I.1, and completely equivalent to count given by tables II-V: $S(3D) + S(2D) + S(1D) + S(t = 0D) = 40 = K(5D)$

As demonstrated by formula (11), $2\ln\left(\frac{m_p}{m_1}\right)$; is the number of pairs of empty particles (change of scale with respect to the maximum mass or Planck mass).

Referring to Table VI and applying the formula (11):

Table VII

81	81	78
$H H$	H	H
	W^+W^-	ZZ
$\ln\left(\frac{m_p}{m_H}\right)$	$2 \ln\left(\frac{m_p}{m_W}\right)$	$2 \ln\left(\frac{m_p}{m_Z}\right)$
$2\gamma b\bar{b}$	$l\nu l\nu$	$4l$

For this table it appears that you need 4 pairs of bosons and 12 particles for the final products of this decay mode of the vacuum, equivalent to the rupture of the symmetry of the vacuum (240) through $E6 \times SU(3)$, with other modes of decay surely isomorphic to this equivalence.

Calculation of the Higgs boson mass. From Table VII it would, because the photon has zero mass, that: $\left(240 - 2 \ln\left(\frac{m_p}{m_W}\right) - 2 \ln\left(\frac{m_p}{m_Z}\right)\right)/2 = \ln\left(\frac{m_p}{m_H}\right)$; but this result needs corrections due to both the 4 pairs of bosons, as 12 final states.

Since the vacuum Higgs gives mass to particles of the standard model, and as that has developed, it would have 39 particles, minus a Higgs boson or Higgs vacuum the same spot as a particle state, then the Higgs vacuum to give their energy to these 39 particles correspond to a value of $39m(V_H)$; that would be necessary to add the same Higgs vacuum as a state final mix $39m(V_H) + m(V_H)$. Since the above expression is the sum of 2-mass states, the symmetry breaking of the undifferentiated (240), by $E6 \times SU(3)$, equivalent to Tables VI-VII, this expression must equal $78m_H$; so that it would have finally:

$$39m(V_H) + m(V_H) = 2m_H \cdot 39 \quad (18)$$

$$\text{Fulfilled that: } 78 + 40 + 2H = 120$$

As the mass of the Higgs boson should be very next to: $m_H = m(V_H)/(78/40)$

The above expression can be reinterpreted as: $m(V_H)/39 + m(V_H) = 2m_H$ (19); where $m(V_H)/39$ is an average of Higgs vacuum as a function of number of particles.

$2m_H - m(V_H)/39 = m(V_H)$; ie a pair of Higgs bosons or a particle-antiparticle pair of H bosons become WW and ZZ, to give the average mass of the Higgs vacuum, we obtain the same Higgs vacuum.

Where the factor $78/40 =$

$$39/20 = 39/(1 + 1 + 2 + 3 + 5 + 8); 1 \cdot 1 \cdot 2 \cdot 3 \cdot 5 \cdot 8 = 240$$

Applying the formula (11) and (18) we have that: $\ln(m_P/m_H) = \ln[m_p/m(V_H)] + \ln(39/20) = 39.110296960597$

$$\ln(39/20) = \ln(1.95)$$

$(78 + 40)/1.95 = 20 = 12 + 8$; 12 particle decay final states + 4 pairs of bosons.

Is known which is fulfilled: $m_H^2 = 2\lambda m^2(V_H)$

However, has shown that: $m^2(V_H)/m_H^2 = 1.95^2$; so: $2\lambda = 1/(1.95)^2$; and $\lambda = 1/2(1.95)^2$

"Surprisingly," this factor also satisfies, 1.95: $(\sum_q m_q)/m_Z = 1.95$

Where $(\sum_q m_q)$; is the sum of the mass of the quarks.

Where $m(V_H)$,mass value is the value of the Higgs vacuum. Therefore the value of the mass of Higgs boson would be, by formula (18): $(246.2212021 \text{ Gev} + \frac{246.2212021 \text{ Gev}}{39})/2 = m_H = 126.2672 \text{ Gev}$

The formula (19) is consistent with the fact the 2 decay modes WW and ZZ, which produce final products of decay with nonzero mass, $l\nu l\nu$; and $4l$

$$H \rightarrow WW \rightarrow l\nu l\nu$$

$$H \rightarrow ZZ \rightarrow 4l$$

3.1.7 Extraordinary properties of Table I

This section will show the extraordinary properties that have this mixture of states that represents this table.

Physical interpretation of the mixture of states represented by Table I The mixture of multiple states and decay modes are not incompatible empty table I.1

It is a table that is generated by 5 states (rows) as the sum of the squares of the first 5 Fibonacci numbers, dividers 240; amount of particle-antiparticle pairs that represents the state of vacuum. The sum of these squares is completely equivalent to the sum of cartesian coordinates or vector sum of spheres and isomorphic to lattice points and that is totally in perfect agreement with the formula (11).

Since we start from the assumption that the table accurately represents the reality of the mathematical structure of the vacuum and its states, then the generation as part of the first row to the first Fibonacci generator, 1, this must represent the first particle or superparticle, which by decay generates 2 particles, $1 + 1 = 2$; etc

But this interaction is self interacting by matrices (the squares of the Fibonacci numbers), so that the structure initially neutral and symmetric vacuum by particle-antiparticle duality, must correspond, we think, to matrix interactions such as:

$$\begin{array}{ccc} c & \bar{p}_1 & \bar{p}_1 \\ p_1 & \gamma & \gamma \\ p_1 & \gamma & \gamma \end{array}$$

Where p_1 y \bar{p}_1 ; 2 represent particle-antiparticle pairs. In general: p_n particles and \bar{p}_n antiparticles corresponding to the Fibonacci numbers dividers 240. The resulting interaction are photons due to its property of being its own antiparticle, and their primary relationship for vacuum generation with minimum energy charged particle stable with the least possible mass, electron (as shown in paragraph 3.1) , are exactly the right choice as possible, since the last row of the table has been shown to be the integer part of the logarithm of the ratio of the square of the Planck mass and the mass of the electron according to the formula (11), and being the last row represents perfectly a progressive decay of the vacuum for 5 transitions of the same. Completing the decay in the last row with the electron. The latter represents the final stage in which the universe state adopted decoupling of radiation-matter particles, and the possibility of attachment of the electron with protons and neutrons to form atomic nuclei. The sum of all states mix (sum of all rows) the exact equivalence of the symmetry breaking and the creation of the masses of the particles through the Higgs boson in the energy range of the first state of unification, which actually represents a transition state of vacuum.

Where the matrices generate all the possibilities of interaction.

Since this amount of states, by the number 162, is a quadratic sum generated by the electron decay ultimately, necessarily, the 162 root has to be about , according to the formula (11) and Table VII equivalence :

$$\sqrt{162} \approx \ln([m_w + m_z])/m_e$$

$$\sqrt{162 - (1/5 + 1/14 + 1/39 + 1/103)^2} = \ln([m_w + m_z]/m_e) \quad (20)$$

$$240 \sqrt{\left(\sum_{F_n/240} F_n^2\right)/240} \approx 2 \ln(m_p/m_Z) + 2 \ln(m_p/m_W) \quad , \quad \sqrt{\left(\sum_{F_n/240} F_n^2\right)/240} \approx (1 - \tan 2\theta_{13})$$

Being the theoretical value given by (20) of a great accuracy respect to the experimental values.

The masses of the bosons w and z are expressible by:

$$\sin \hat{\theta}(m_Z) (\overline{MS}) \approx \ln(240) - 5$$

$$162/2 - [1 + \cos \hat{\theta}(m_Z) (\overline{MS})] = 2 \ln(m_p/m_W)$$

$$162/2 - [3 - \cos \hat{\theta}(m_Z) (\overline{MS})] = 2 \ln(m_p/m_Z)$$

$$78/162 \approx \sin \hat{\theta}(m_Z) (\overline{MS}) \approx \sqrt{0.23116}$$

If, as mentioned, this table accurately represents the states of the vacuum; necessarily each row and concretely the sum mixture thereof, would be equivalent, except the last row which gives the integer value of the electron mass by formula (11) with a double value, it is 5 transition states of the vacuum, or 5 states of unification.

Therefore, should have approximately the masses of transition-unification of these 5 states of vacuum could be expressed applying the formula (11) and approximately, as:

Table VIII

- Level I : $\lfloor \ln(m_P/m_1) \rfloor \cong 1$ Planck scale
- Level II : $\lfloor \ln(m_P/m_2) \rfloor \cong 5$ GUT scale unification
- Level III : $\lfloor \ln(m_P/m_3) \rfloor \cong 14$ Unification scale unknown
- Level IV : $\lfloor \ln(m_P/m_4) \rfloor \cong 39$ Electroweak unification scale
- Level V : $\lfloor \ln(m_P/m_5) \rfloor \cong 103$ Final scale of minimum energy with smaller non-zero mass and electric charge (electron).
With its associated particles: tau, muon, neutrinos the three associated with the smallest non-zero mass with no electric charge.

Level II GUT unification match perfectly with the theoretical value GUT, because:

$$\ln(\exp(-5) \cdot m_P/m_Z) = 34.43577 ; \text{ a value very close to the theoretical of } \cong 33.2 \cong \ln(m_X/m_Z)$$

$$34.43577 - 2(\varphi - 1) \cong \ln(m_X/m_Z)$$

The effects of particle interaction with the relevant groups in each row must correct the mass value of each level by a calculation equivalent to the renormalization, which at present unknown.

However, for Table I is exactly in conformity with reality, in the sense that it should have negative values for naturally and according to the formula (11) is fulfilled:

$\exp(-n)m_P = m ; m < m_p$, have to contemplate imaginary values for the Fibonacci numbers dividers 240, so that it is necessary to reinterpret the amount of particle-antiparticle pairs of empty, 240, as the difference of "energy" that account for negative values of Table I. This way:

$$240 = 78 - (-162)$$

But for reasons imposed, first by general relativity and secondly by further development to be presented, it is necessary to consider the values of these Fibonacci numbers in terms of quaternions.

General relativity imposes $\rho - 3p$; so you should consider.

Quaternions applied to the states of Table I If we apply the quaternions to Table I, relying on the negative solution for antiparticles as Dirac, we obtain a value-added mix:

$$i^2 162 + j^2 162 + k^2 162 + ijk 162 + 1^2 \cdot 162 + (-1)^2 \cdot 162 + 6 = -2 \cdot 162 + 6$$

Where states have added the 6 Fibonacci number 1, which is repeated by the Fibonacci series, which appears to act as neutral element.

$$1, 1, 2, 3, 5, 8, \dots$$

Therefore, according the broken symmetry by $E6 \times SU(3)$; finally we have a difference of "energy":

$$i^2 162 + j^2 162 + k^2 162 + ijk 162 + 1^2 \cdot 162 + (-1)^2 \cdot 162 + 6 + 78 = -240 = -18^2 + (162 - 78)$$

To "normalize" the previous result is only necessary to change the signs:

$$-1^2 \cdot 162 - (-1)^2 \cdot 162 - 6 - 78 - (i^2 162 + j^2 162 + k^2 162 + ijk 162) = 240$$

We have seen above, in paragraph 3.1.8, as the integer part of α^{-1} can be expressed as the sum of all the photon polarization states for 7, 3 dimensions, and the time dimension represented by 0, $2^7 + 2^3 + 2^0 = 137 = \lfloor \alpha^{-1} \rfloor$

The sum of the baryon density, the density of of the vacuum energy and of matter called dark, we have: $\Omega_b + \Omega_v + \Omega_d = 1$

$$(1 + 2 + 3 + 4) = (7 + 3)$$

$$(\Omega_b + \Omega_v)(7 + 3)^2 = (0.045840614385 + 0.725044382451)100 = 77.0884996$$

$$\dim(E6) - \ln^{-1}(3) \cong (\Omega_b + \Omega_v)(7 + 3)^2$$

$$(\Omega_b + \Omega_v + \Omega_d)(7 + 3)^2 = 10^2 ; 240 - (\Omega_b + \Omega_v + \Omega_d)(7 + 3)^2 = 2\sqrt{\sum_{n=1}^{24} n^2}$$

$$d2\Omega_b/2\Omega_b = (7 + 3)^2 \left[\frac{2}{-162+78} + \frac{1}{-162 \times 78 / (78/162-78)} \right] ; \text{so integrated is obtained:}$$

$$\int d2\Omega_b/2\Omega_b = \ln(2\Omega_b) = C + \left((7 + 3)^2 \left[\frac{2}{-162+78} + \frac{1}{-162 \times 78 / (78/[162-78])} \right] \right) ; \text{and finally:}$$

$$2\Omega_b \cong \exp \left((7 + 3)^2 \left[\frac{2}{-162+78} + \frac{1}{-162 \times 78 / (78/[162-78])} \right] \right) ; \text{a result very close to}$$

$$\text{obtained by equation } \left(2 \ln \left(\frac{m_p}{m_e} \right) + \alpha^{-1} \right) - 240 = 2\Omega_b$$

The difference $-162 + 78$; represents the asymmetry matter antimatter, since counting

with the 4 states of quaternions, we have an approximation to Ω_b :

$$1/\Omega_b \cong (162 - 78)/4 = (162 - 78)/2^2 ; \dim[SO(7)] = (162 - 78)/4$$

$$\text{Fulfilled also that: } \sqrt[16]{(1^2 + 2^2 + 3^2 + 4^2)/4} = \sin^{-1} \theta_w ; \cos \theta_w = m_w/m_z$$

Later notes the importance of $1^2 + 2^2 + 3^2 + 4^2$

If Table I is consistent with the cosmological solutions of general relativity, equivalence could be established such that: $-3p \iff -3 \cdot 162 - (7 + 3) = -496$; or real dimensions in the field of actual group $E8$.That is, be met and only counting the positive solution of Dirac, that:

$$i^2 162 + j^2 162 + k^2 162 + ijk 162 - (7 + 3) + 1^2 \cdot 162 = -496 = -\dim \text{ real } (E8) \iff -3p \quad (21)$$

$$(1 + 2 + 3 + 4 = 7 + 3) ; (1 \cdot 2 \cdot 3 \cdot 4) = 24 \quad \sum_{n=1}^{24} n^2 = 70^2$$

This should include supersymmetry with 32 supercharges high, which force the appearance of the graviton.

Are you 32 supercharges might relate to the table so that I?:

$$2^5 \times 162 = 72^2 = (K(6D))^2 ; \text{where 5 corresponds to the 5 states mixture of the 5 rows of the table.}$$

Here, as will be seen later is appearing a value close to 70, for which show that for the value of the cosmological vacuum: $\left[\ln(m_P/m_v) \right] = 70$

One might propose that the value of the Higgs boson mass of less massive, relative to the electron mass is:

$$(-496)^2 + 32^2 = 40(1^2 + 5^2 + 14^2 + 39^2 + 103^2) = 494080 = 2m_H/m_e$$

$$(m_H/m_e)/40 = (2^5 \times 162 = 72^2 = (K(6D))^2) + 2 \cdot 496$$

Therefore, should be to fulfill that: $\ln(m_P/([494080]/2)m_e) = \ln(m_H/m_e)$; Equation of paragraph 3.1.8: $\ln(m_P/([494080]/2)m_e) = \ln(m_H/m_e) = 39.110535526566$

And this is indeed a very good approximation.

But has to observe that: $32^2 = 2^7 \cdot 2^3$; or the product of all possible states of polarization of the photon in 7 and 3 dimensions. Then, 32 does it represent the supercharges or

the possible states of polarization of the photon to $(7 + 3)/2$; equal the sum of the 4 states of quaternions applied to Table I, more positive energy solution?.

The point of minimum energy of the oscillator to the vacuum is given by:

$E = \frac{1}{2}\hbar\omega$; by what one has a particle density ratio $\hbar\omega/E = 2$; equal to the value obtained for the minimum uncertainty value according to the Heisenberg principle: $2 = \hbar/\Delta p \Delta x$

interpreting 2 as a dimensionless density differential ratio of particles, due to the minimum value of zero point energy, or the minimum uncertainty; and considering a negative energy value by expansion pressure, one would have:

$-2 = d\rho(p)/\rho(p)$; that integrating yields: $\exp -2 = 1/\exp 2$; which is also a density ratio of particles, and therefore a second differential, since being calculated on the zero point of vacuum. Therefore, $(1/\exp 2)^{-1}$, represents particle-number states.

$\exp(2) = 7.389056099$; is the sum of the basic states of possible polarization of the photon in 7 dimensions plus a remainder decimal, which is seen later, has to do with the value of the equivalent mass of the energy of cosmological vacuum in relation to the Planck mass, so that, approximately, is fulfilled with this rest decimal, that:

$$m_P c^2 \exp(-70 - \exp(2) + 7)/1.602176565 \times 10^{-19} C \approx E_v(ev) \cdot \sqrt{2} = (2.32585 \times 10^{-3} ev) \cdot \sqrt{2}$$

Value agrees very well with the experimental value. By the formula (21) has 5 states, 4 of quaternions and 1 in the positive solution of Dirac (equivalent).

These states must be subtracted, so that we obtain the following differential, maintaining a state of "energy" negative:

$$d2\Omega_b/2\Omega_b = -[(\exp 2) - 5]; \text{ and integrating gives us a value highly consistent with } \Omega_b$$

$$\int d2\Omega_b/2\Omega_b = -\int (\exp 2) - 5; \ln 2\Omega_b = C - [(\exp 2) - 5]; 2\Omega_b \approx 0.0917162; \text{ very approximate value to that obtained by formula (14).}$$

The Weyl group , the Fibonacci numbers and the divisors of 240 As is known, the order of the Weyl group of E8 is 696729600, and can be expressed as:

$$(1!1!2!3!5!8!)(1+1+2+3+5) = 696729600$$

And with these numbers Fibonacci divisors of 240, there are these interesting connections : 1. $\{F_n(d)/240\} = \{1, 1, 2, 3, 5, 8\}$

$$m_H/m_e = \sum_{n=1}^6 (-1)^n \cdot \sum_{n=1}^6 (F_n)^n + 4 \cdot \sum_{n=1}^6 (F_n)^2 = 247040 = [\dim \text{real}(E8)]^2 + 32^2$$

$$\sum_{n=1}^6 F_n = 20 ; \sum_{n=1}^6 (F_n)^2 = 104 ; \sum_{n=1}^6 (F_n)^3 = 26^2 - 2 = (26 + i\sqrt{2})(26 - i\sqrt{2}) ; \sum_{n=1}^6 (F_n)^4 = 4820 ;$$

$$\sum_{n=1}^6 (F_n)^5 = 36170 ; \sum_{n=1}^6 (F_n)^6 = 278564$$

$$2. \exp[(11 = 1 + 2 + 3 + 5) + (1/1^2 + 1/2^2 + 1/3^2 + 1/5^2 + 1/8^2)] + 2 \left(\sqrt{\sum_{n=1}^{24} n^2} + [1/1 + 1/1 + 1/2 + 1/3 + 1/5 + 1/8]^{-1} \right) = m_H/m_e = 247040$$

$$3. (1/1! + 1/2! + 1/3! + 1/5! + 1/8!) \cong (1 + \sin(2\pi/\varphi^2))$$

$$4. \left(1/[(1!)^2 + (2!)^2 + (3!)^2 + (5!)^2 + (8!)^2] \right) \cdot \left(1 + 1/2\pi \sum_{n=1}^6 F_n \right) \cong (n_b - \bar{n}_b)/\gamma \cong 6.2 \times 10^{-2}$$

Where F_n ; is the nth Fibonacci number.

$$5. \exp(4\pi) \cdot (9000/9178) \cong 1 \cdot 5 \cdot 14 \cdot 39 \cdot 103$$

6. The lower order of the 26 sporadic groups, the Mathieu group 11, constructed with the group of permutations of sets of 11 elements with order 7920.

$$7920 = (\dim[SU(13)] + 162)4! = 11!/7! \left(70/2 \right) \cdot \left(7920 - 2\pi\alpha^{-1} \right) - \ln^2(\alpha^{-1}) = 247040 = m_H/m_e$$

The order of the Mathieu group can be expressed as a group under the group SU(89), where 89 is the 11th Fibonacci number: $7920 = 89^2 - 1$

$$7. 162 \text{ can also be expressed by: } 1^3 + 1^3 + 2^3 + 3^3 + 5^3 ; \dim(E6) = 2(1^2 + 2^2 + 3^2 + 5^2)$$

$$8. \left[2 \ln(m_p/m_e) - 1/\left(\sqrt{\varphi^6 - 1}\right) \right] \pi \cong \varphi^{12} + 1$$

$$9. \exp[(2 + (\varphi - 1)/2)^2] + 1/\varphi^{10} = m_\mu/m_e$$

10 The sum of amount of possible permutations for each row of Table II: $1! + 2! + 3! + 4! + 5! = 153 = 1^3 + 5^3 + 3^3 ; (153 + \sqrt[4]{2}) = \ln^2(m_H/m_e)$

$$(1!2!3!4!5!) \cdot 7 + 5 \cdot 32^2 = 247040 = m_H/m_e$$

10. Row sum values, except the value 1, Table I: $(162/\pi) - \exp -[(1/5 + 1/14 + 1/39 + 1/103)^{-1}] \cong \ln(m_p/m_e)$

$$[\dim(F4) - (1/1 + 1/1 + 1/5 + 1/14 + 1/39 + 1/103)^{-1}]\pi = 162.00092 \cong 162$$

$\sqrt{(1/1 + 1/1 + 1/5 + 1/14 + 1/39 + 1/103)^{-1}} \cong (1 - \tan 2\theta_{13})$; θ_{13} = neutrino oscillation angle vacuum (call set would be empty angle), related, as will be shown later, with lengths 7 dimensional relationship or ratio relative to that of Planck. $\theta_{13} = 9.433531269^\circ$

Numeric connections that can not be casual In the context of all Developed so far, will present a numerical correlations can not be casual, we think, and need further study on them.

1. $(78/162) - \sin \widehat{\theta}(m_Z) (\overline{MS}) \cong 1/[\ln^2(m_P/m_H) - 2\ln(m_P/m_H)]$
2. $\lambda^{-1} \cong (8 - 2\Omega_b) - 1/[2\exp(1/2)]$ be 1/2 ; the minimum value of uncertainty given by: $(\Delta x \Delta p)/\hbar = \frac{1}{2}$

Although you can perform an approximation if one takes into account, applying the formula (11), that $(\Delta x \Delta p)/\hbar = \frac{1}{2}$; can be considered as the differential ratio of the minimum value of uncertainty that coincides with the minimum value of the ratio of the oscillator energy zero point vacuum, regarding $\hbar\omega$;and therefore interpretable according to the formula (11) as ratio of amount of particles. It's actually an equivalence.

$$E(0)/\hbar\omega = 1/2 = dn/n ;$$

Since the vacuum "creates" virtual particle antiparticle pairs, one might propose:

$$(E(0)_+/\hbar\omega) + (E(0)_-/\hbar\omega) = (dn_+/n) + (dn_-/n)$$

$$\text{integrating: } (\int (dn_+/n) = 1/2) + (\int (dn_-/n) = 1/2) = 2\exp(1/2) + C$$

1. It is known that the Heisenberg uncertainty principle is fulfilled: $H_x + H_y \geq \ln(\pi e)$.
2. $\ln(m_P/m_H) \cdot (\ln(\pi e) + 1) \cong \varphi^{10}$; $\varphi = \lim_n \rightarrow \infty \frac{F_n}{F_{n-1}}$; where F stands for the numbers of the Fibonacci series.

3.1.8 Relationship of the value of the Higgs mass with the density value Ω_v

Be shown as the value obtained for the parameter Ω_v has a close relationship with the fractional part of the fine structure constant for energy = 0

Breakdown of the value of the fine structure constant and its physical meaning This constant has an integer part equal to 137 and some decimal = 0.035999084

Integer part: It seems that the whole is the sum of the photon polarization states for dimensions 7, 3 and 0, or time. In fact: $2^7 + 2^3 + 2^0 = 137$

And also this decomposition corresponds to: $K(7D) + 11D = 126 + 11 = \dim[SO(7)] \cdot \dim[SO(4)] + K(3D) - 1$

Since the theoretical model followed so far the decimal part is a fraction of the baryonic density, $2\Omega_b$; the inverse of this part decimal represents amount of pairs of particles, ie: $n_d(p) = 1/0.035999084 = 27.778484585886$; and that closely approximates to the dimension of the rotations in 8D, $\dim[SO(8)] = 28$, the 2nd perfect number after 6, $28 = 2^4(2^3 - 1)$; taking the number of standard model particles, excluding the triplicity of quarks due to color, since we are counting only the photon and electroweak plus 4 theorized = $6l + 6q + 3B_{wz} + 1\gamma + 8g + 2H + 2sH$ (*Higgsinos?*) = $28 = 2\dim(G2)$

However, the number of particles involved in purely electroweak forces are 12, 6 leptons, 3 electroweak bosons, the photon and Higgs, necessarily 2. That if we exclude the quarks. Counting quarks and electroweak bosons discounting, there are also 12 particles.

This would be thus the contribution, missing the coupling of density Ω_v ; and since the inverse square of the inverse density is a probability, ie number of particles, then theoretically you could write the following equation:

$$2(12 + 1/\Omega_v^2) \approx n_d(p) = 1/0.035999084 = 27.778484585886$$

But necessarily, it seems that there should be a contribution of the Higgs boson as a probability / density negative to give up their energy to create the masses of the particles and the 3 leptonic electroweak bosons, and considering the coupling of Ω_v ; equal to: $1/\left(\ln\left(\frac{m_p}{m_H}\right) - \Omega_v\right) = 1/\left(39.110296960597 - 0.725044382451\right)$

$$\text{By equation (15) and (16) it would: } 2(12 + 1/\Omega_v^2) - 1/\left(\ln\left(\frac{m_p}{m_H}\right) - \Omega_v\right) = 2(12 + 1/(0.725044382451)^2) - 1/\left(\ln\left(\frac{m_p}{m_H}\right) - \Omega_v\right) = 27.7784765637622$$

Seems that a more accurate value is obtained by:

$$2(12 + 1/\Omega_v^2) - 1/\left(\ln\left(\frac{m_p}{m_H}\right) - \Omega_v + 1/\left[\ln\left(\frac{m_p}{m_H}\right)/\sin\hat{\theta}(m_Z) (\overline{MS})\right]\right) = 27.778484904363$$

The most approximate value of the Higgs boson mass has been obtained previously by the factor 1.95 and the involvement of Ω_v , Leads us to ask whether once he has given both the dark mass, like the observable universe by the asymmetry with respect to 240, there is only the density of the vacuum itself, so it is very likely that this density is precisely the generator of the equivalent mass ratio of Higgs vacuum and neutral Higgs boson itself.

We propose that the Higgs boson mass as a function of Ω_v ; can be expressed as:

$$m_H \approx m(V_H)\Omega_v/\sqrt{2} \quad (20) \quad ; \quad \Omega_v = 0.725044382451$$

$$\ln(m_P/m_H) \approx 39.110563587139 \quad (22); \quad 126.233621\text{Gev}$$

3.1.9 Table states dependent sum of the groups $SU(n)$ with, n, number of Fibonacci divisor of 240 and the calculation of the boson mass Higgs lighter.

Like was obtained breaking the symmetry of the vacuum with Table I; you can get directly the breaking of this symmetry respect to the boson mass Higgs lighter, to obtain its mass in relation to the electron mass.

For this purpose, a table is generated sum of states with the groups $U(1)$, $SU(n)$; n being a Fibonacci number divisor of 240. The table shall be drawn with partial sums $dim[SU(n)]$, $dim[U(1)]$;the same way that was generated Table I

Tabla IX

$dim[U(1)]$					
$dim[U(1)]$					
$dim[U(1)]+$	$dim[SU(2)]$				= 153
$dim[U(1)]+$	$dim[SU(2)]+$	$dim[SU(3)]$			
$dim[U(1)]+$	$dim[SU(2)]+$	$dim[SU(3)]+$	$dim[SU(5)]$		
$dim[U(1)]+$	$dim[SU(2)]+$	$dim[SU(3)]+$	$dim[SU(5)]+$	$dim[SU(8)]$	

$$\ln^2(m_H/m_e) \cong 153 + \ln 153/(\sqrt{5} + 2)$$

3.2 Mass of the neutrino and the mass equivalent to the minimum energy of the graviton

In the formula (5) also can be considered breaking the symmetry of the vacuum if it contemplates the inclusion of neutrinos, which so far have not been considered. If the photonics part of the rupture of vacuum is given by the inverse of the fine structure constant, as already shown. Simply stating the decay $\gamma \rightarrow \nu + \bar{\nu}$; yields a minimum value for the smaller mass of the 3 neutrinos, given by the formula (11):

$$m\nu c^2 = m_P c^2 \exp(-\alpha^{-1}/2) = 3.422931 \times 10^{-22} = 2.1364261 \times 10^{-2} ev \quad (23)$$

Value that matches the experimental estimates, according to which $m\nu_e < 2.2 ev$ and the combined mass of cosmological neutrinos would be estimated less than 0.68 eV.

We consider this value as a minimum, referring to the electron neutrino, being then an approximate value would need to know the small quantum corrections.

Mass equivalent to the energy of a graviton+++ Proceeding in the same way as for the mass of the neutrino, but considering that the graviton is its own antiparticle, then breaking the vacuum would be given by:

$240/2 = 120 = 5! = 60 \cdot 2$; giving us an equivalent mass of the energy given by:

$$m_g = m_P \exp(-120) = 1.66881 \times 10^{-60} Kg \quad (24);$$

value agrees well with estimates based on various cosmology and quantum theories.

But we can deduce a result which by its simplicity seems to indicate the value given by (24). If the gravitational potential for masses of the order of the Higgs boson energy differs little from the expression Newtonian corrections except perhaps for high masses near the GUT or Planck mass, in terms exponential repulsive as proposed by several theories of quantum gravity, and since Higgs field gives mass to particles (which emit gravitons under certain conditions of motion), is it possible that the value of the energy of the graviton roughly match the value of the self-energy gravitational potential for the boson mass Higgs lighter at a distance equal to its wavelength?

Let us examine:

$$m_H = 247040 \cdot m_e; \lambda_H = \hbar/m_H c; m_g c^2 = m_H^2 G/\lambda_H; \text{ Applying the formula (11), it would have: } \ln[m_P/(m_H^2 G/c^2 \lambda_H)] = 117.3316065797 \quad (25)$$

And unexpectedly you have the following results: a) $3 \ln(m_P/m_H) \cong 117.3316065797$; b) $\exp(120 - 117.3316065797) \cong \ln(m_H/m_e) + 2$; c) $\exp(120 - 117.3316065797 - 2) \cong m(V_H)/m_H$

Appearing again the Fibonacci numbers, divisors of 240: $\ln(m_H/m_e) + 2 \cong 26/2 + (1/1^2 + 1/2^2 + 1/3^2 + 1/5^2 + 1/8^2)$

Although an almost exact result is given by: $\ln[(m_H/m_e) - 2(70 + [1/1 + 1/1 + 1/2 + 1/3 + 1/5 + 1/8]^{-1})] + 2 \cong 26/2 + (1/1^2 + 1/2^2 + 1/3^2 + 1/5^2 + 1/8^2)$

$$\ln(m_H/m_e) - 1/R_H^4(26) + 2 \cong 26/2 + (1/1^2 + 1/2^2 + 1/3^2 + 1/5^2 + 1/8^2)$$

Again there is an approximate value of the cosmological vacuum.

3.3 The cosmological vacuum

See again Table II

x^2y	xyx	yx^2
y^2x	yxy	xy^2
x^2z	xzx	zx^2
z^2x	zxx	xz^2
z^2y	zyz	yz^2
y^2z	$yz y$	zy^2
xyz	zyx	xzy

A torus has the same volume as the surface of an n-dimensional sphere, ie a kind of holography in this sphere.

Both areas such as the torus have a positive external curvature and an inner, for the

external and internal surfaces. When turning on itself a dimension in a three dimensional cartesian coordinate system, as in Table II, in reality is equivalent also to perform a 90° turn of 2 adjacent coordinates, so that, for example, the coordinate x , and y become indistinguishable and form a circular winding. This 90° turn produces curvature negative internal and external positive.

Are quaternions and octonions which allow us to make this turn and get the internal negative curvature.

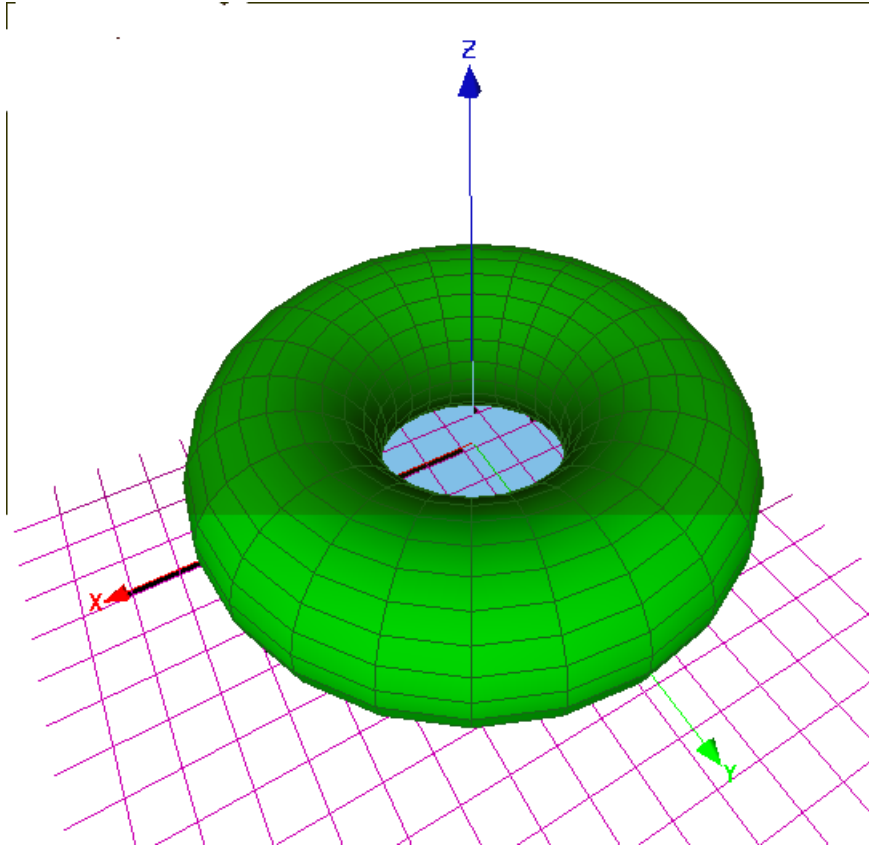

The three states that are applied to each row, changing the coordinate sequence to get all combinations of each row of the table, except the last, in the which are wound 2 dimensions sequentially together to produce a torus, are the following equivalent (we could have chosen any winding coordinate):

1

$$x = y \quad (ix)^2 = -x^2$$

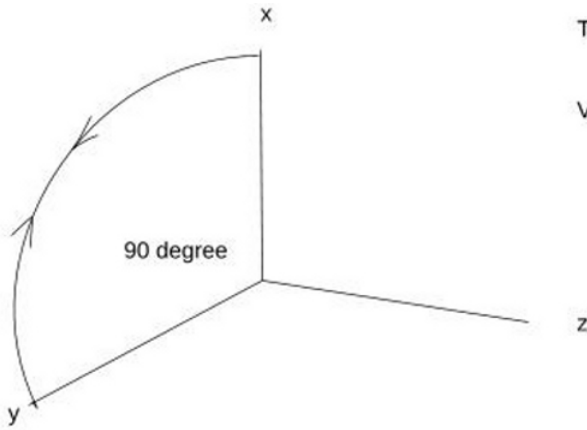

Torus creation state

$$\text{Volume Torus} = 2(\text{PI})^2(x^2y)$$

2

Torus creation state

Volume Torus

$$2(\text{PI})^2x^2y$$

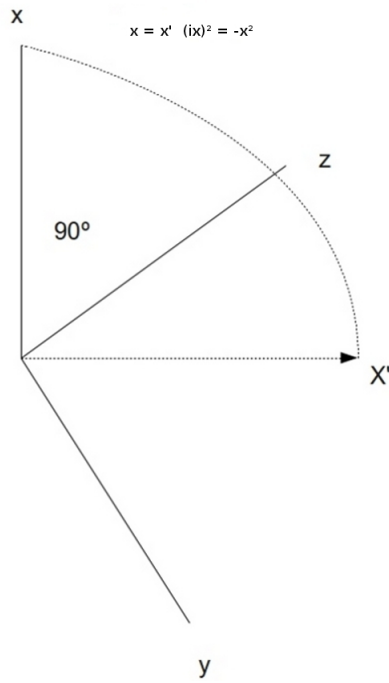

3

Torus creation state

$$x = z \quad (ix)^2 = -x^2$$

Volume Torus

$$2(\pi)^2 x^2 y$$

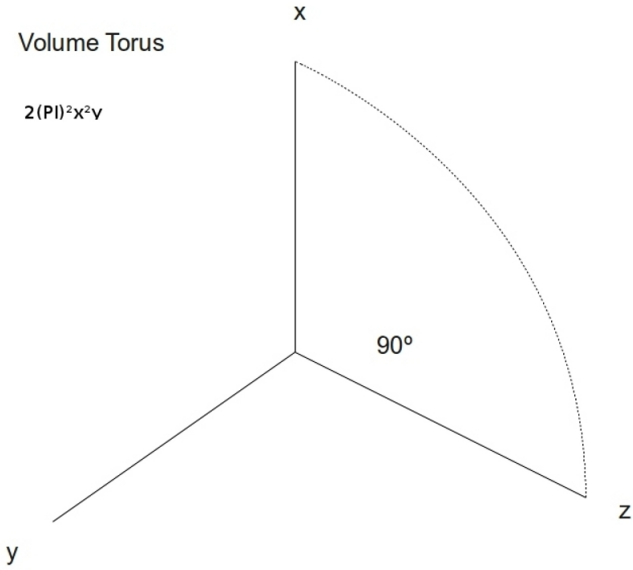

Therefore, for each row of the table and for the coordinate that is wound, let x, y, or, z shall apply the operation consecutively for each imaginari quaternion i, j, k : $x^2, xyz ; \dots, (ix)^2 ; (iy)^2 ; (iz)^2 \dots, (kx)^2$; except the last row, which applies the operation to 2 of the coordinates $xyz \dots$, sequentially, to get a torus. States are added: $(-x)^2, (x)^2 \dots$, representing the negative and positive energy solution for the relativistic equation: $E^2 = p^2 c^2 + m^2 c^4$

With this operation, adding the positive and negative states, we obtain a total of:

21×3 ; negative states by the three quaternions $i ; j ; k$ and positive and negative state by applying the 2 possible solutions to the relativistic equation, they cancel each other, and we are 63 states of negative energy. This result is consistent with the sum of the positive energy density more negative pressure, discounting antimatter-matter asymmetry corresponding to the negative solution of the equation relativistic cosmological solutions of general relativity, since it satisfies the equivalence:

$$63 = \dim[SU(8)]$$

$$-3 \cdot (21 \text{ states}) + (21 \text{ states}) \iff -3p + \rho$$

A negative area automatically imply a negative pressure and a negative energy density as pressure and energy density are a function of a force divided by area, as is well known.

The length of the dimensions become unit value, as a scaling function, applying the formula (11)

$$x = 1, y = 1, z = 1 \quad l_p/l_p = 1$$

In Table II, the value of the 21 states, by its length defined above, is the same, although the permutation, or variation is different.

The operation of creating the 70 states of negative energy torus is simply applied to each pair of dimensions of the 3 axes, x, y and z, the product $ixiy = i^2 xy$; (which is the basic algebraic expression of the surface of a torus), and repeating this operation,

first with the 7 imaginary octonions more the 3 imaginary values of the quaternions, having the direction of rotation, ie if, for example, x is z bends, and vice versa. Time dimension is added independently.

In this way, as shown in the figure, are obtained 70 states of negative energy, given by:

$$7 \times 7 + 3 \times 7 = 70 \quad \sum_{n=1}^{24} x_n^2 = 70^2$$

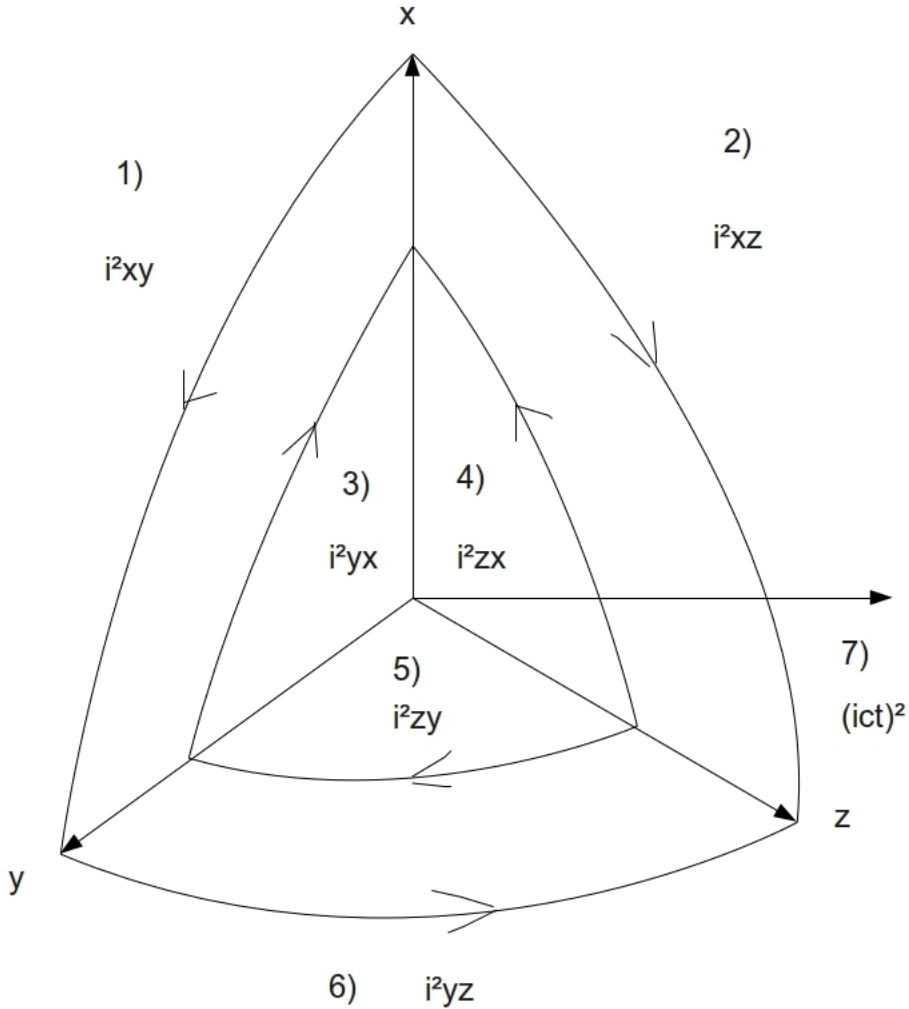

$$70 = 7 \text{ octonions} \times 7 \text{ states} + 3 \text{ quaternions} \times 7 \text{ states}$$

Creation of 70 toric states of negative energy
with the octonions and quaternions.
One state for time dimension.

To break the symmetry of 240, E8 group, by E6 x SU (3), consider the matrix product and the interaction of the sum of the basis states, which are given by negative values of the multiplication table of octonions and quaternions, ie values imaginary octonions and quaternions squared imaginary.

The product: $-7 \times -3 = 21$

The matrix of elements: $(7 + 3)^2$; interaction matrix-valued energy-negative states.

The breaking of the symmetry of E(8) by E(6) x SU(3), can be obtained as:

$$\left|21 - 100\right| = 79 ; \left|21 - 140\right| = 161$$

The apparent discrepancy (79, 161) and (78, 162), comes from the matrix, in fact, a group SU (10) with dimension 99, and that the state 1 is the 161 lacks, for 1 also represents the vacuum state with value 0; $2^0 = 1$. That is the reason of the occurrence of 163 and 168, if each row of the table I added the number repeated the Fibonacci series. 1 represents one of the group U (1) and the other represents the value of the vacuum state 0, but counts as 1 state. Being 168: $dim[SU(13)] = 168$

Thus, whereas the net energy is the energy difference of positive and negative, we have finally that the net energy is:

$$(0 - (-99)) + (0 - (-140)) + (0 - (-1)) = 240$$

Here is where the involvement of the formula (11), since 140, is to get 70 other states simply by making the imaginary octonions and quaternions take a negative value, thereby allowing 70 other negative states: $-i \cdot -i = i^2$;

If applied to table I, the entire operation with the 7 imaginary octonions and 3 imaginary quaternions have a total of states: $10 \times 21 = 70 \times 3 = 210$

And again, shows the to equal relativistic equivalence: $\rho - 3p \iff 70 - 3 \times 70 = -2 \times 70 = -140$

If we consider only positive states of compacted dimensions, using the 2 possible values of the root of the equation relativistic total energy, or what is the same:

$1x1y.....$; $-1x-1y.....$; gives the dimension of the group G2, and is met: $140 - 7 = dim(E7)$; $140 - 14 = dim[K(7D)] = 126$

However, given that the number of particles of the vacuum, not counting antiparticles, are 120, then subtracting the negative amount given by the group SU(10), we have the integer value of the inverse of the density of baryons:

$$21 = -7 \times -3 = \left[\Omega_b^{-1}\right] = 2 \cdot 11D - 1 = dim[SO(7)]$$

We are therefore faced with a simultaneous multistate or mixture. 24 dimensions that are exactly the permutations of 4 dimensions, we perceive extended. The difference between quantity of particles, states and dimensions seems to melt, leading us to conclude that the vague concept of mass as quantity of material should be pointed out as the number of particles having mass by the winding at the quantum level, and this compactification of space is literally the mass . The distinction between space, matter and energy is diluted. Energy is the mass in motion or vibration, the moving space-time-warp.

Applying the formula (11), it must be for the value of vacuum is due to meet: $\left[\ln(m_P/m_v)\right] = 70$

Would lack the interacción corrections. One possible way to calculate this correction is to consider the following argument:

Discussed above, and for the Higgs boson mass, formula (22) is satisfied: $\ln(m_P/([494080]/2)m_e) = \ln(m_H/m_e) = 39.110535526566$; a value quite close to that of standard model particles 40, according to this theory. Possibly this asymmetry has to be due precisely to the negative energy contribution of cosmological vacuum. The most logical is that if you obey the assumptions of this theory can be use the formula (11), and considering the vector sum of states-particles as lattice points-number of particles would have finally:

$$40^2 - [\ln(m_H/m_e) = 39.110535526566]^2 = 70.36601082522 = \ln(m_P/m_v) \quad (26)$$

$$\left[m_P c^2 \exp(-70.36601082522) \right] / 1.602176565 \times 10^{-19} C = 2.3800812 \times 10^{-3} \sqrt{2} \text{ ev} ;$$

$$\text{Value coincides precisely with the experimental value of } \approx 2.39 \times 10^{-3} \text{ ev} \quad (27)$$

This value, likewise, seems to be consistent to that obtained according to:

$$m_H/m_e = \sum_{n=1}^6 (-1)^n \cdot \sum_{n=1}^6 (F_n)^n + 4 \cdot \sum_{n=1}^6 (F_n)^2 = 247040 = [\dim \text{ real}(E8)]^2 + 32^2$$

$$\sum_{n=1}^6 F_n = 20 ; \sum_{n=1}^6 (F_n)^2 = 104 ; \sum_{n=1}^6 (F_n)^3 = 26^2 - 2 = (26 + i\sqrt{2})(26 - i\sqrt{2}) ; \sum_{n=1}^6 (F_n)^4 = 4820 ;$$

$\sum_{n=1}^6 (F_n)^5 = 36170 ; \sum_{n=1}^6 (F_n)^6 = 278564$; If one considers the reciprocals of the numbers derived from Table I and VIII, as a summation of densities of particles, counting to the sixth power, indication perhaps of the dimensionality of a torus in 7 dimensions with a volume of sixth power, or equivalent to the surface of a sphere in 7 dimensions.

It would have, with $F_n(M162)$; Referring to the mixed-state numbers of the sums of Fibonacci numbers of the divisors of 240 rows of Table I (5, 14, 39 and 103, 4-dimensional states): $\text{sum}(1/5^n + 1/14^n + 1/39^n + 1/103^n, n = 1..6) = 0.363026777741724$; in an approximation to the value obtained by the fractional part of (26) 0.36601082522

The square root of 2 is explained, we think, several facts: the cosmological relativistic expression: $\rho - 3p = -2\rho$

Perhaps, only if the negative vacuum energy can be tunneled to give positive energy in processes such cooperation could match those of the experiment neutrinos Opera, the coincidence could be explained the expression relativistic and the transfer of energy to neutrinos and they return it back to this vacuum in a closed loop (so that no Cherenkov radiation), and being a virtualized process does not follow the quadratic equation relativistic acquiring this tunnelwinds a speed exceeding that of light with limit values. This would have related to the lightest neutrino mass, electronic and maybe the other 2, since it would be next to this energy vacuum, thus allowing, together with the low interaction of the neutrino have the way clear for this interaction with this state of vacuum.

One might even think that neutrino oscillations are caused by this interaction with the vacuum.

A positive energy in certain circumstances, it would make sense if this vacuum has a self-interaction so that:

$2\rho = \sqrt{(\rho\sqrt{2})^2 + (\rho\sqrt{2})^2}$; formula consistent with the value of zero point vacuum and the relativistic expression, as well as the Heisenberg uncertainty principle.

$$2E = \hbar\omega ; 2\Delta p\Delta x \leq \hbar \geq 2\Delta E\Delta t$$

The oscillation of neutrinos (as well as the rest): $\Delta m_{13}^2 \cong 2.32 \times 10^{-3} eV^2$ by this interaction or interference with the vacuum, if you notice that the theoretical results have been presented, would have the formula (11) and do tunneling?:

$$(23) [40^2 - \ln^2(m_p/m_H) - (\alpha^{-1}/2)] = \ln(m_\nu/m_\nu) = \lambda_\nu/\lambda_\nu$$

$$[2.39 \times 10^{-3} eV \cdot \exp(\cos \theta_w \lambda_\nu^2/\lambda_\nu^2)]^2 = 2.32 \times 10^{-3} eV^2$$

The 21 basis states are the product of the 7 dimensions rolled and 3 extended. Likewise, we must: $\zeta(-7) = 1/240 ; \zeta(-3) = 1/120$

-7 And -3 are precisely negative values of the multiplication table of octonions and quaternions, ie: there is an "isomorphism" between the amount of wound dimensions (7), extended the 3 and negative values of multiplication tables of quaternions and octonions.

If states previously obtained by the application of quaternions to Table II, we substitute using the octonions, 126 states are obtained, which is precisamnete the kissing number of spheres in 7 dimensions. Having that: $[dim(G2)]^2 - 70 = 126$

An asymmetry between positive and negative states automatically lead to a repulsive force instability expansive.

We believe that the universe arose by a single particle, and by expanding the energy-space-time left the value of the vacuum residue, leaving the negative value observed.

The equivalence between mass, energy and space-time imply that if you create space for expansion beyond the edge of the observable universe, with a speed exceeding that of light, you have to create matter-energy as are mass amounts of particles, which in turn have a mass that is, ultimately, number of dimensions-states, their transformations, distortions, etc.. This creation of matter would not be incompatible with the universe inside the sphere with the light speed limit, except the tunnel effect of neutrinos between the vacuum and themselves. Once the limit of the universe is overtaken by another layer limit the expansion, the previous layer has created a lot of space, has drained the energy of space-time (it has "cooled" the space-time) by ray emission gamma γ ? and other particles; apply the energy conservation within the part of the bubble expansive with limiting velocity equal to c, since the vacuum has remained in the minimum energy state possible and creating matter only occurs on the edge limit expansion.

4 Calculation of dimensions 7D-spherical torus and its possible implications.

With everything that has shown so far, one reaches the conclusion that spacetime is structured in 7 dimensions that bend, or rolled due to a repulsive force regarding an energy center; more 3 extended dimensions and time dimension. This center would be

that of a torus or its equivalent: the center of a sphere. The volume of the torus is equal to the surface of a sphere d dimensional, as is known. The surface of a sphere in d dimensions has dimension d-1, so that for a radio unit:

$$S_{d-1} = 2\pi^{d/2}r^{d-1}/\Gamma(d/2) \quad (28) \quad (\text{"Black holes and the Existence of extra dimensions"})$$

There is extensive literature on the calculation of the size of the compacted dimensions Kaluza-Klein type, which are those that coincide exactly with the ideas of this theory.

We refer to this literature, namely: "Black holes and the Existence of extra dimensions" Rosemarie Aben, Milenna van Dijk, Nanne Louw.

The d dimensional gravitational potential is given by:

$V(r) = -G_{d+4}mM/r^{d+1}$; where m and M are the masses, where M is the mass compacted into a "cylinder". G_{d+4} ; is the Newton gravitational constant in a space-time (4 + d) dimensional. ("Black holes and the Existence of extra dimensions").

$G_{d+4} = 2G_N \sum d/S_{d-1}$; $\sum d = (2\pi r)^d$; this last expression is the compactification in circles d times.

The d dimensional Planck length is expressed as: $l_P(d) = \left(\hbar G_{d+4} / c^3 \right)^{1/(d+2)}$ (29) ("Black holes and the existence of extra dimensions").

The ratio of (29) and the Planck length, is a dimensionless number that means the amount of times the Planck length is contained in the d dimensional Planck length:

At this rate it now as we symbolize $l_p(D) = l_P(d)/l_P$

$$l_P(d)/l_P = \frac{\left(\hbar G_{d+4} / c^3 \right)^{1/(d+2)}}{\left(\hbar G_N / c^3 \right)^{1/2}} = \left(2(2\pi)^d / \left[2\pi^{d/2} / \Gamma(d/2) \right] \right)^{\frac{1}{d+2}} \quad (30)$$

The ratio of the length of a black hole d dimensional respect to the Planck length would be:

$$R_H(D) = R_H(d)/l_p = \left(4(2\pi)^d / \left[2\pi^{d/2} / \Gamma(d/2) \right] \cdot (d+1) \right)^{\frac{1}{d+1}} \quad (31) \quad (\text{"Black holes and the existence of extra dimensions"}).$$

Propose that the torus 7 dimensional are formed by a smaller radius of compactification which coincides with (31) and a larger radius which coincides with (30)

This includes a torus-sphere radius black hole solution, because if a black hole due to similar laws of evaporation at that scale, then it is a candidate for the massive emission of photons, which in turn decay into particle-antiparticle pairs .

As we have seen the breakdown of symmetry of the vacuum in its final state involves stabilization in a photonic and an electronic part, which would confirm this choice.

The ratio of the Planck length with itself: $l_P/l_P = 1$

And finally the length corresponding to that derived from the fine structure constant (13), which we call as: $l_\gamma = r = \sqrt{\frac{\alpha^{-1}}{4\pi}} = 3.30226866228015$

The calculation of (26) and (27) give the following values:

$$l_P(7D) = 3.0579009561024 \quad ; \quad R_H(7D) = 2.956949058224$$

Therefore, we have 4 size or 4 lengths.

Considering the formula (11) and crosslinking particle number as sum of squares or coordinates cartesian spherical, it would:

$$l_P^2(7D) + R_H^2(7D) + l_\gamma^2 + 1^2 = 29.999284308147 \cong 1^2 + 2^2 + 3^2 + 4^2 = 30 \quad (32)$$

However, the above expression is also a solution with negative lengths, so that: $(-l_P(7D))^2 + (-R_H(7D))^2 + (-l_\gamma)^2 + 1^2 = 29.999284308147 \cong 1^2 + 2^2 + 3^2 + 4^2 = 30$

$$1 + 2 + 3 + 4 = 7 + 3 \quad ; \quad 4! = 24 = \dim[SU(5)] \quad ; \quad 26 - \dim[SU(4)] = 11D$$

In total: 59.9985686162932 ;particles. Fulfilling an isomorphism between the amount of particles and 2 possible solutions to the total energy, according to the equation of special relativity: $E = \sqrt{p^2c^2 + m^2c^4}$; you have 2 solutions, one positive and one negative energy.

If supersymmetry exists, then it will automatically have the 120 particles that were previously obtained as the maximum number of particles from the vacuum: $2 \cdot 59.9985686162932 = 119.99713723259 \cong 120$

This indicates very slight asymmetry in all probability, the difference from 120 should be related to the baryonic density, as in previous sections showed.

If in (32) are used imaginary values of quaternions, including ijk , 120 particles are obtained, considering

$$\text{the net amount with respect to 0 particles (0 energy): } (0 - \sum_{\{i,j,k,ijk\}}^c [(cl_P(7D))^2 + (cR_H(7D))^2 + (cl_\gamma)^2 + (c1)^2] \cong 120 \quad (33)$$

If done the same with the values of the imaginary octonions have:

$$0 - \sum_{\{e_1, e_2, e_3, e_4, e_5, e_6, e_7\}}^o [(ol_P(7D))^2 + (oR_H(7D))^2 + (ol_\gamma)^2 + (o1)^2] \cong 210 \quad (34), \text{ this expression being isomorphic to the expression of general relativity: } -3p \quad ; \text{ and again reaches the same result as in previous sections, because: } \rho = p \quad ; \quad (30) \quad 210/3 =$$

$$\left[\ln(m_P/m_v) \right] = 70 = \sqrt{\sum_{n=1}^{24} n^2} \quad ; \quad \dim[SU(5)] + \dim[SU(4)] = \dim(E6)/2$$

$$\text{Taking approximately that: } 120 - \Omega_b / \ln^2(2 \cdot [l_P^2(7D) + R_H^2(7D) + l_\gamma^2 + 1^2]) \cong 4 \cdot [l_P^2(7D) + R_H^2(7D) + l_\gamma^2 + 1^2]$$

By (32), which represents the positive energy solution, we have finally:

$$l_P^2(7D) + R_H^2(7D) + l_\gamma^2 + 1^2 + 0 - \sum_{\{e_1, e_2, e_3, e_4, e_5, e_6, e_7\}}^o [(ol_P(7D))^2 + (oR_H(7D))^2 + (ol_\gamma)^2 + (o1)^2] \cong 240 \quad (35)$$

The following figure below shows the coordinates $l_P(7D)$; $R_H(7D)$; l_γ ;in the center of the torus, with the transfer of Rh (7D)

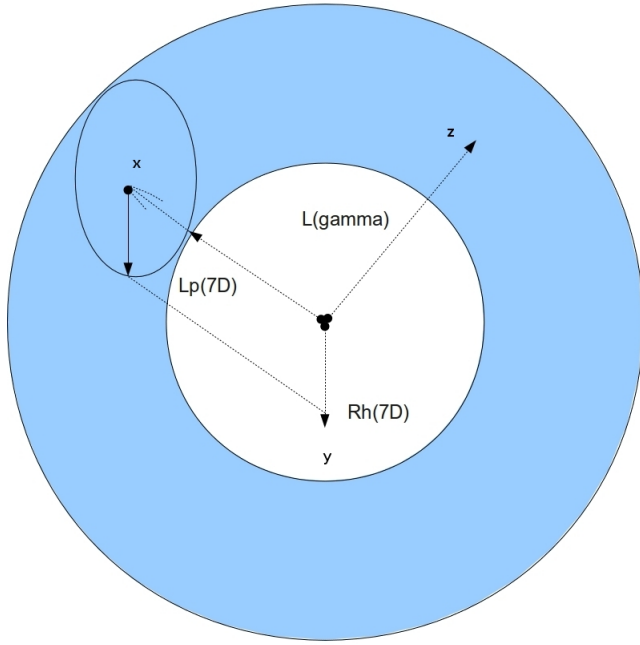

4.1 Principle of holography

Clearly and repeatedly shown an encoding of information, number of particles on a surface as the sum of the squares of cartesian coordinates of d-dimensional spheres. This reiteration suggests existence of a principle or law of holography in the information, at least in 2D. Note that every natural number can be expressed as the sum of 4 spherical coordinates of integer values, as is well known, that is: based on 4 dimensions.

The holographic principle would be a confirmation of the theories proposed by Gerard 't Hooft and improved and promoted by Leonard Susskind, among others.

And this makes perfect sense, since the quadratic equations are the fastest in solving algorithmic level and appear with great frequency in all areas of physics.

Do note, that there is not an algorithm which employs only basic operations, along with the roots, to obtain solutions to algebraic equations in one variable with degree greater than or equal to 5.

The quadratic equation whose solution, known to all:

$x = (-b \pm \sqrt{b^2 - 4ac})/2a$; algorithmically can be decomposed by 8 main terms:

1. 2 terms by the 2 solutions \pm
2. 1 term by $-b$

3. 1 term by $\sqrt{\quad}$
4. 1 term by b^2
5. 1 term by $-4ac$
6. 1 term for the operation of division
7. 1 term by $2a$

A total of 8 terms, and counting the operational elements of each term, we obtain

14 basic elements; so that for a space of 3 and 4 dimensions, we have:

$$2^3 \text{ qubits} ; 2^4 \text{ qubits} > 14$$

In short: with the space of 3 and 4 dimensions can compute a 2D holography in a single computation step.

We think this is mostly the holographic principle encoding fundamental physical characteristics derived from certain surfaces.

It has 4 dimensions, missing another 7 to complete the alleged 11 dimensions.

4.2 11 dimensions Model

Since it has a coordinate $x = 1 = l_p/l_p$; we would fail to introduce four-dimensional coordinates with: $x = 1 = l_P(x)/l_P(x)$; $y = 1 = l_P(y)/l_P(y)$; $z = 1 = l_P(z)/l_P(z)$; $l_P(ct)/l_P(ct) = 1 = t(ct)$

By the Heisenberg uncertainty principle, with the minimum value of uncertainty, and the minimum energy of the oscillator zero point, we have, as has been seen that:

$2E \cdot t = \hbar\omega t = 2\Delta E\Delta t = 2\Delta x\Delta p$; implying that for each coordinate $l_p/l_p = 1$; can coexist at least 4 states of uncertainty as other extra dimensions, or the 4 states of zero point for the 4 coordinates, x, y, z and t.

This result would be equivalent to the mixing of polarization states of photons that allowed us to obtain the integer value of the fine structure constant, given that:

$$11^2 + 2^4 = 137 = 2^7 + 2^3 + 2^0$$

In this way, the sum of cartesian coordinates of this sphere 11 dimensional, would give a value:

$$l_P^2(7D) + R_H^2(7D) + l_\gamma^2 + l_P^2(x) + l_P^2(y) + l_P^2(z) + l_P^2(ct) + 2^2 + 2^2 + 2^2 + 2^2 = 48.999284308147 \cong 7^2 \quad (36)$$

$$7^2 = \dim[SU(10) - 1]/2 ; (120 = 5!) - \sqrt{7! + 1} = 7^2$$

Since there are 7 curled up dimensions $l_p(7D)$; $R_H(7D)$, by (36) it would have 7^3 ; Particle-dimensions-states.

$$\lfloor \ln(m_p/m_e) \rfloor = 103$$

$$7^3 = 240 + 103 = K(10D) + 7$$

It is assumed that the structure of space-time-energy is multistate and can take different configurations.

As was shown in paragraph 3.1.10, the coupling angles depend on the number of particles involved.

Since according to (32) and the existence of supersymmetry, there are 60 particles and 60 other companions, would have a first torus angle $\theta_{t1} = 2\pi/2(l_P^2(7D) + R_H^2(7D) + l_\gamma^2 + 1^2)$

And this angle is practically equal to: $(l_\gamma - R_H(7D))/l_\gamma \cong \sin(2\pi/2[l_P^2(7D) + R_H^2(7D) + l_\gamma^2 + 1^2]) \cong \sin^2 2\theta_{13}$ (37)

Could be interpreted as a coupling angle because the length $R_H(7D)$ oscillates back the length l_γ ; and counting a minimum uncertainty = 2, and its projection as a spherical coordinate, you would: $(l_\gamma - R_H(7D))/l_\gamma = 4 \cdot (\sin \theta_{13} \cos \theta_{13})^2 = \sin^2 2\theta_{13} \cong \sin \theta_{t1}$

Clearly indicates an oscillatory phenomenon-vibration between 2 lengths.

This angle, which is very close to current experimental value, which is still a substantial percentage of inaccuracy, is: $\theta_{13} = 9.433531^\circ$

The angle of oscillation of neutrinos in vacuum, we think that this angle is exactly θ_{13} ; the intimate relation of the neutrino as immediate energy scale of cosmological vacuum.

This last equation would indicate, on the other hand, a parametric coordinate of a torus, because: $x(\frac{\pi}{2} - \theta_{t1}, 2\pi) = R \cos(2\pi) + r \cos(\frac{\pi}{2} - \theta_{t1}) \cos(2\pi) \cong R_H(7D) \cos(2\pi) + 4l_\gamma \cdot (\sin \theta_{13} \cos \theta_{13})^2 = l_\gamma$

For symmetry and allow another oscillation, this time between $l_P(7D)$ and l_γ

Assuming that the length l_γ is an oscillatory state $l_P(7D)$;by vibrating the torus, presents a graph of the oscillation of the inner contour of the torus, made with the math 8.0.4 program.

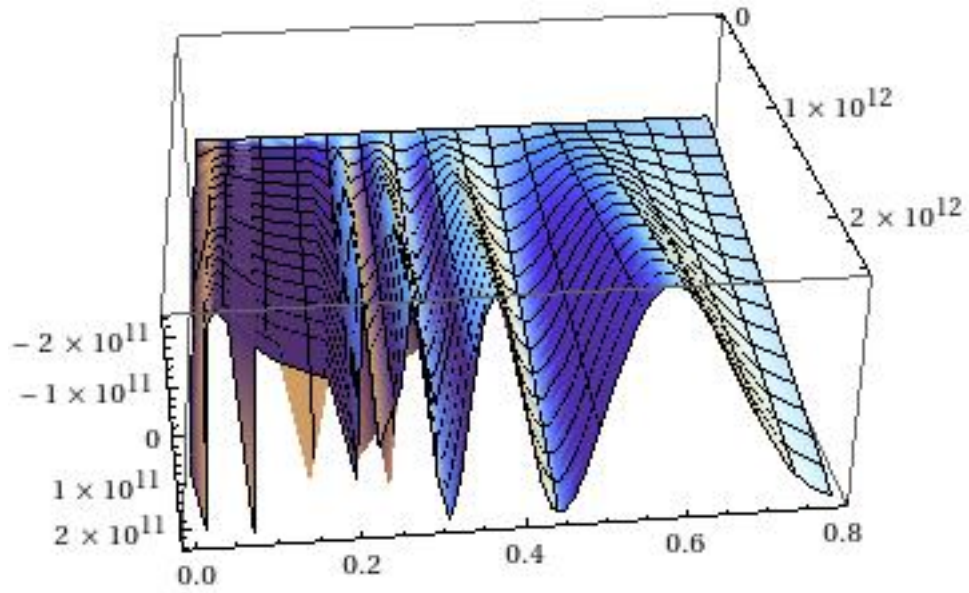

Graph I oscillation

Plot3D $\left[3.0579009561024 + \left((3.05790095610241 - 2.9569490582249) \times \text{Sin} \left[\frac{2 \times \text{Pi}}{x} \right] \right) / \dots \dots \right.$
 $\left. \dots \dots \left(0.164646176 \times \text{Sin} \left[\frac{2 \times \text{Pi}}{y} \right] \right), \{x, 0, 0.7853981\}, \{y, 0, 2416609733531\} \right]$

$$l_\gamma \cong l_P(7D) + (l_\gamma - R_H(7D)) \sin(2\pi/8) / \cos\left(\theta_{13} \sin(2\pi/26)\right)$$

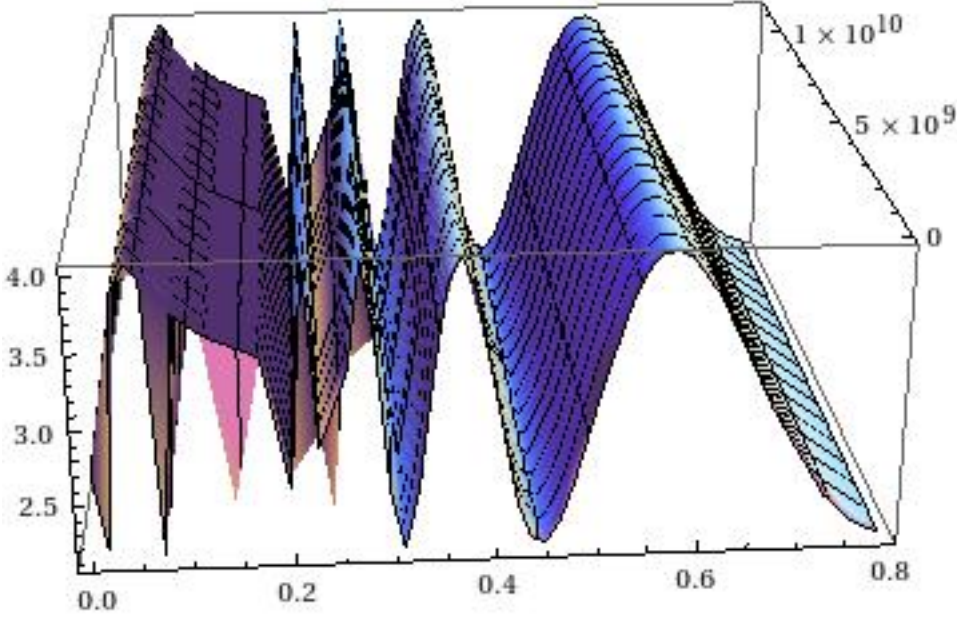

Graph II oscillation Plot3D $[3.0579009561024 + ((3.05790095610241 - 2.9569490582249) \times \text{Sin} [\frac{2 \times \text{Pi}}{x}])] / \dots$

..... $(0.1047197551197 \times (\text{Tan} [\frac{2 \times \text{Pi}}{y}] - 1)) , \{x, 0, 0.7853981\}, \{y, 0, 11634749432\}$

$$l_\gamma \cong l_P(7D) + (l_\gamma - R_H(7D)) \sin(2\pi/8) / \cos\left(\left[\frac{2\pi}{60}\right] (\tan[2\pi / \sum_s \sqrt{s(s+1)}] - 1)\right) ; s \in \{0, 1/2, 1, 3/2, 2\}$$

4.2.1 Observations of some relationships on the number of standard model particles

The current standard model consists of a family of 3 with 3 charged leptons neutrinos associated with spin 1/2 or fermions.

Then have the 6 fermions with color charge and electric charge +2 / 3, -1 / 3

In total there are 12 fermions. Meanwhile, you have 12 bosons in the group SU(3), with 8 gluons, 3 bosons of the group SU(2) and photon group U(1). It can be seen as it appears the series 3, 6, 12 and 24

3, for the 3 families or generations of leptons, quarks. The 6 as the total number of quarks and leptons to electroparticles: electron, muon, tau neutrinos and their 3 partners.

The 12 for the total number of leptons and bosons exchange, so it equals the sum of quarks and electroparticles. 24 as the sum total.

This count is identical or "isomorphic" to the count given in paragraph d) of paragraph 3.1.5.1 and equals the number of permutations of 4 dimensions.

Finally we have that: $K(2D) = 6$, $K(3D) = 12$, $K(4D) = 24$

6 quarks x 3 colors = 18 quarks, 18 quarks + 6 leptons + 12 bosons = 36 = $K(3D) + K(4D)$

$K(3D) + K(4D) + 3$ family groups = 39 = $\lfloor \ln(m_P/m_H) \rfloor = \dim(E6)/2$

4.2.2 Number of particles of interaction and coupling angles.

There is a general natural angle that seems to generate all the others. This angle is a direct function of the seven windings by the application of the squares of the imaginary octonions, to generate the energy states of the vacuum toroidal states by the seventy views. The value of symmetry of the vacuum, 240, obtained by (35). This angle is simply the ratio of seven windings and spherical cartesian coordinates of (35):

$$(\pi/2) - (2\pi/60) = (2\pi \cdot 7/30) = \theta_0 \cong \frac{\pi}{2} - \theta_{t1}$$

$$(\pi/2) - (2\pi/2[l_P^2(7D) + R_H^2(7D) + l_\gamma^2 + 1^2]) = (2\pi \cdot 7/[l_P^2(7D) + R_H^2(7D) + l_\gamma^2 + 1^2])$$

$$[l_P^2(7D) + R_H^2(7D) + l_\gamma^2 + 1^2] \cong 30$$

$$\sum_{n=e_o}^{e_\tau} (n \sqrt[4]{l_P(7D)})^8 + (n \sqrt[4]{R_H(7D)})^8 + (n \sqrt[4]{l_\gamma})^8 + (n \sqrt[4]{l_P/l_p})^8 \cong 240$$

The properties of this angle are the following:

1. $\theta_0 = \theta_w + \theta_c + \theta_\varphi + \arcsin(1/[240 - 60])$, or $\arcsin(1/[(3^3 - 1)/2]^2)$ θ_w ; $\cos \theta_w = m_W/m_Z$ Cabibbo angle = θ_c ; $\theta_\varphi =$ Golden angle = $\pi - (2\pi/\varphi^2)$, $\varphi =$ Golden ratio
2. $\theta_0 \cong \theta_w(GUT) + \theta_1$
3. $\theta_0/[dim[SU(2)] \cos(2\pi/60)] = \theta_w$
4. $\theta_w(GUT) \cong \theta_0(3 \sin \theta_{thd1} - 2)$
5. $3 \text{ colors} \cdot 6 \text{ quarks} + 8 \text{ gluons} = 26$, $\theta_c \cong \theta_0/[R_H(26)/\cos(\theta_{13}/dim[SU(3)])]$

If calculated the angle of curvature needed to obtain Ω_b^{-1} ; solving the equation: $[l_P(7D) + R_H(7D) \cos \theta_1]R_H(7D) - \Omega_b^{-1} \cos \theta_1 =$

0

Angle is obtained: $\theta_1 = 46.23076128^\circ$; a value very close to $360/8 = 45^\circ$

This angle seems to have a definite relation to the tetrahedron (supersymmetry, colors), it can be expressed as a function of the Weinberg angle of unification, the GUT scale.

Tetrahedron: Angle between an edge and a face (θ_{thd1}). Height: for a regular tetrahedron of edge length a: ($H = (\sqrt{6}/3)a$).
 $(\sqrt{6}/3) = \sin \theta_{thd1}$

Radius of circumsphere: $R = (3/8)a$; $3/8 = \sin^2 \theta_w(GUT)$

$\theta_1 \cong \theta_w(GUT) / \sin \theta_{thd1}$; $\theta_w(GUT) = 37.7612439070351^\circ$; $37.7612439070351^\circ / \sin \theta_{thd1} = 46.24788\dots$

This angle has a curious property: $r = 1$; $\theta_1 = 2\pi / [(\sqrt{240 + r^{10}\pi^5/120})/2]$; where $r^{10}\pi^5/120$ is the volume of a sphere 10 D with unit radius.

Looking at the values of angles for the electroweak force and the exchange interaction of quarks, we find that the angles are a feature that seems to depend on total number of particles that interact.

Specifically, for the electroweak angle given by: $\cos \theta_w = \frac{m_W}{m_Z}$

Table I, adding another element as the first row, the repeated number of the Fibonacci series, 1, as the Fibonacci sequence is generated from 0, is obtained as the sum total of the number 163 and states the average particles: $\frac{163}{6}$

For the electroweak force fermionic particle number are 12, 6 quarks and 6 electroparticles (electron, muon, tau, neutrinos: their partners), and the number of bosons exchange, without the strong force of color, are 3 bosons, w +, w-, z, plus the photon (4 bosons). The total for the quarks and electroparticles, get 2 equal groups of $6 + 4 = 10$ particles.

With the fine structure constant and the average given by $163/6$, it seems possible to obtain with great precision electroweak angle factor given by the mass of the W and Z boson.

$$\theta_w = 2\pi / \left\{ 10 / \left(\sqrt{(\alpha^{-1} - 137)^{-1} - 163/6} \right) \right\}$$

$$[1 - (\ln 24 - 1)/10]^2 + 163/6 \cong (\alpha^{-1} - 137)^{-1}$$

With the expression (22) will have to: $\ln(m_P/m_H) \cdot \sin(2\pi/40) = 10[(\alpha^{-1} - 137)^{-1} - 163/6]$

Strong force for change flavors of quarks, the Cabibbo angle main, there are 18 quarks due to the 3 color charges, plus 9 exchanges flavor elements given by the CKM matrix and isomorphic to 9 CKM matrix elements by 3 colors in total: 27-state particles.

And the approximate angle of Cabibbo

$$\theta_{c12} \cong 2\pi/27$$

But as in the previous case the electroweak angle, appears to be a dependency, with the strong coupling constant to the energy scale of the Z boson.

$$\theta_{c12} = 2\pi / \left(27 + \alpha_s(m_Z) \cdot \sqrt{27} \right)$$

And the 2 angles appear to be a common relationship, given by a similar generating function: $\theta_{c12} = 2\pi / (27 + [\sqrt{27} / \{8 + \ln(40/27)\}])$; where $\sqrt{27} = \sqrt{3^2 + 3^2 + 3^2}$; is the vector sum of the elements of the CKM matrix for the 3 color charges; 8 are the gluons and $\ln(40/27)$; is the difference of the sum of probabilities $1/n(p)$,integrating the differential $dn(p)/n(p)$; where $n(p) = 40$ and 27 respectively, being 40 the total amount of particles K (5D) and 27 are the amount of CKM matrix elements multiplied by the 3 color charges. Fulfilling as has been shown that: $\frac{40 \cdot 6}{27 \cdot 6} = \frac{240}{162} \cong (1 + \sin[2\pi/\varphi^2])$; $40 - 27 = 13 = 3^2 + 2^2 = 8g + 1\gamma + 1w^+ + 1w^- + 1z + 1H = CKM(9) + 1\gamma + 1w^+ + 1w^- + 1z$

$$\theta_w = 2\pi / (12 + 2 \cdot \ln(40/27)) ; 2 = \sqrt{1^2 + 1^2 + 1^2 + 1^2} ; 1w^+, 1w^-, 1z, 1\gamma$$

$$\text{Precisely } 26 = 6q \cdot 3c + 8g = 6q + 3l + 3\nu + 1w^+ + 1w^- + 1z + 1\gamma + 8g + 2H$$

$$\text{And } 2^2 - 1 = \dim[SU(2)] , 2^3 = \dim[SU(3)]$$

The angle of oscillation of neutrinos in vacuum. The characteristics of neutrinos and especially its nonzero mass value so close to the value of cosmological vacuum, along with the more than probable overcoming the speed of light by tunnel effect between this vacuum of negative energy and neutrinos, suggests that it is linked to lower particle nonzero mass, and considering that the physical states always tend to adopt the minimum energy state, we can hypothetically imagine a decay process starting from the particle more massive of 40 theorized in this model, to a state of space-time 4 and 5 dimensional holography possibly E6 group, you can reach the final state of neutrino traveling these 40 particles or states of space-time-energy.

Later show how this angle seems to depend on dimensionless values of certain lengths in dimension 7 with respect to the Planck length.

This angle because of the definitions so far would be approximately:

$$\theta_{13} = 2\pi/40$$

One observation, perhaps not trivial, is that the product of the number of elements of the CKM matrix of quarks and that of the matrix elements of neutrino oscillation is precisely: $240 - \dim(E6)/2 = 162/2$; y que $40 = \dim[SU(9)]/2$

More than likely not a coincidence: $\tan \theta_c = \sin^2 \hat{\theta}(m_Z) (\overline{MS})$; $\theta_c = 13.04^\circ$

4.3 The 26 dimensions and the Higgs vacuum

The introduction of twenty-six dimensions, it seems more than a theoretical device. Show, as with the values of these dimensions, following the Kaluza-Klein compactification is obtained very simply, the amount of vacuum particles, the known number 240

There is a deeper geometry of the unknown to its foundations, but we can glimpse some essential features.

The main features of the underlying geometry, are derived by assuming a formula that expresses the total number of particles in the symmetric vacuum. This formula is as follows. Kaluza-Klein lengths, including a black hole, as the second toroidal dimension.

$$l_P(26) = l_P(26)/l_P = \left(2(2\pi)^d / \left[2\pi^{d/2}/\Gamma(d/2)\right]\right)^{\frac{1}{d+2}}$$

$$R_H(26) = R_H(26)/l_p = \left(4(2\pi)^{26} / \left[2\pi^{26/2}/\Gamma(26/2)\right] \cdot (26+1)\right)^{\frac{1}{26+1}} = 6.43989730373194 \quad (38)$$

First, it must be noted that the twenty-six dimensions, are incorporated into the dimension of the group F4 (26 x 2). The sum of the squares of all numbers Fibonacci consecutive divisors of 240, is exactly twice the dimension of the group F4, or four times the dimension 26

$$\sum_{F_n/240} F_n^2 = 1^2 + 1^2 + 2^2 + 3^2 + 5^2 + 8^2 = 26 \cdot 4 = 2dim(F4) \quad (39)$$

The radius of a sphere as a function of the Kaluza-Klein two lengths on twenty-six dimensions:

$$R_S(26) = \sqrt{l_P^2(26) + R_H^2(26)} = 9.23017780651394 \quad (40)$$

The total amount of vacuum particles (K (8D) = 240):

$$26R_S(26) \cong 240 \quad (41), \quad 26R_S(26) = 239.984622969362$$

The very slight asymmetry with respect to 240, seems to depend on the angle as a function of the twenty-six dimensions:

$$240 - 26R_S(26) \cong [\exp(\sin^{-1}(2\pi/26)) - \ln(4/\pi)]^{-1}$$

$$26R_S(26) + [\exp(\sin^{-1}(2\pi/26)) - \ln(4/\pi)]^{-1} = 240.0000001017$$

If the theory we are developing, is consistent with reality, the formula 40 implies necessarily that the radius of this sphere of twenty-six dimensions to be consistent with the theory, must be the sum of spherical cartesian coordinates, but with roots integers. Strictly, it seems necessary, to preserve the product $104 = 26 \times 4$, (39), that the roots of these integers allow applying the squared values of quaternions get the same value in different states, that is:

$$R_S(26) = (i\sqrt[4]{x_1})^4 + (i\sqrt[4]{x_2})^4 + \dots + (i\sqrt[4]{x_n})^4 \quad (42)$$

The interpretation of the formulas 40, 41 and 42, is very clear: the length of the twenty-six dimensions seems to consist of four-dimensional volumes. This result would confirm as operations with the three basic dimensions and time by mixing different states, generate the compacted dimensions. This compactification, again, would confirm the fundamental role of the curvature by the octonions and quaternions for. Likewise, the fractality of space-time would be very likely. Also explain how the angle θ_{13} , derived from the ratio of the length corresponding to the length of light planck, minus the length toroidal black hole in seven dimensions with respect to the length of the light planck would, following the formula 11, one function of the application of this scaling law (formula 11) using what might be a minimum length that would generate the other. This length would be the fourth root of the sum of twenty-six dimensional sphere with unit length, relative to that of Planck. Likewise, this algebra quarters dimensional roots of integers would correspond to the generation of states of different electric charges.

$$\exp(-\sqrt[4]{26}) \cong (l_\gamma - R_H(7D)) / l_\gamma \cong \sin^2 2\theta_{13}$$

Twenty-six dimensional sphere with radius unity (l_p/l_p):

$$26 = \sum_{26} (i1)^4$$

$$\sum_{F_n/240} F_n^2 = 104 = \sum_{26} (i1)^4 + \sum_{26} (j1)^4 + \sum_{26} (k1)^4 + \sum_{26} (1 \cdot 1)^4$$

$$(i\sqrt[4]{1})^8 + (i\sqrt[4]{1})^8 + (i\sqrt[4]{2})^8 + (i\sqrt[4]{3})^8 + (i\sqrt[4]{5})^8 + (i\sqrt[4]{8})^8 = 104$$

$$(i\sqrt[4]{1})^8 + (j\sqrt[4]{2})^8 + (k\sqrt[4]{3})^8 + (1\sqrt[4]{5})^8 + (-1\sqrt[4]{8})^8 + (1\sqrt[4]{1})^8 = 104$$

With the octonions:

$$\sum_{n=e_0}^{e_7} (n\sqrt[4]{1})^8 + (n\sqrt[4]{2})^8 + (n\sqrt[4]{3})^8 + (n\sqrt[4]{5})^8 + (n\sqrt[4]{8})^8 + (-1^2\sqrt[4]{1})^8 = \dim \text{real}(E8) + 2\dim[SU(13)]$$

$$\sum_{n=e_0}^{e_7} (n\sqrt[4]{1})^8 + (n\sqrt[4]{2})^8 + (n\sqrt[4]{3})^8 + (n\sqrt[4]{5})^8 + (n\sqrt[4]{8})^8 + (-1^2\sqrt[4]{1})^8 = \dim \text{real}(E8) + K(10D)$$

K(10D) is the kissing number of 10D; $\dim \text{real}(E8) = 2 \cdot 248$

Surprisingly, this radius of this sphere of twenty-six dimensions, can be expressed in terms of the Fibonacci numbers, divisors of 240, using the formula (42)

$$R_S(26) \cong (i\sqrt[4]{1})^4 + (i\sqrt[4]{2})^4 + (i\sqrt[4]{3})^4 + (i\sqrt[4]{5})^4 + (i\sqrt[4]{8})^4 + (2/\lfloor \ln(m_p/m_e) \rfloor)$$

$$(i\sqrt[4]{1})^4 + (i\sqrt[4]{2})^4 + (i\sqrt[4]{3})^4 + (i\sqrt[4]{5})^4 + (i\sqrt[4]{8})^4 + (2/\lfloor \ln(m_p/m_e) \rfloor) = 9.23017694791611$$

$$(i\sqrt[4]{1})^4 + (i\sqrt[4]{2})^4 + (i\sqrt[4]{3})^4 + (i\sqrt[4]{5})^4 + (i\sqrt[4]{8})^4 + (2/\lfloor \ln(m_p/m_e) \rfloor) \cong 9.23017780651394 = R_S(26)$$

$$26[(i\sqrt[4]{1})^4 + (i\sqrt[4]{2})^4 + (i\sqrt[4]{3})^4 + (i\sqrt[4]{5})^4 + (i\sqrt[4]{8})^4] + 1/(\sum_{p \leq 7} \sqrt{p})^2 \cong 240, \quad p = \text{prime number}$$

$$[(l_P(7D) + R_H(7D))/2]^{-2} + 39 = \ln(m_H/m_e)$$

$$\sqrt{26(\sqrt[4]{1} + \sqrt[4]{2} + \sqrt[4]{3} + \sqrt[4]{5} + \sqrt[4]{8})} \cong 12 + \ln \ln 26$$

$$(l_P(7D) \ln \ln 26 - 3)^2 = (\alpha^{-1} - 137)^{-1} - 163/6$$

1. $\exp[\sqrt{26(\sqrt[4]{1} + \sqrt[4]{2} + \sqrt[4]{3} + \sqrt[4]{5} + \sqrt[4]{8})}]/(m(V_H)/m_e) \cong \ln(\sqrt{1} + \sum_{p \leq 7} \sqrt{p})$; p = prime number

2. $\left((m(V_H)/m_e)/\exp[\sqrt{26(\sqrt[4]{1} + \sqrt[4]{2} + \sqrt[4]{3} + \sqrt[4]{5} + \sqrt[4]{8})}]\right)^4 + 6 = \sqrt[4]{1} + \sqrt[4]{2} + \sqrt[4]{3} + \sqrt[4]{5} + \sqrt[4]{8} - [10(l_P(26) - 6)]^{-4}$

3. $\sqrt{\sin^2 \theta_w(GUT) + (2\dim(E6) + (1^{-2} + 2^{-2} + 3^{-2} + 5^{-2}))^{-2}} + 6 = 6.6124053911345 \cong l_p(26) = 6.61240539117563,$ 240-
 $(1^3 + 1^3 + 2^3 + 3^3 + 5^3) = \dim(E6), \quad \sin^2 \theta_w(GUT) = 3/2^3$

4. $\exp\left(2\sqrt{l_P^2(26) + R_H^2(26)/2}\right)/\ln[l_P(26)] = 247068.979781173 \cong m_H/m_e$

5. $\pi R_S(26) = 28.997458788272 \cong l_P^2(7D) + R_H^2(7D) + l_\gamma^2 = 28.999284308147$

6. $\sum_{n=e_0}^{e_7} (n\sqrt[4]{l_P(7D)})^8 + (n\sqrt[4]{R_H(7D)})^8 + (n\sqrt[4]{l_\gamma})^8 + (n\sqrt[4]{l_P/l_p})^8 = 239.97967030618$

7. We believe that this equation confirms without doubt the reality of this algebra dimensional, fourth roots of integers :

$$\sum_{n=e_0}^{e_7} (n \sqrt[4]{l_P(7D)})^8 + (n \sqrt[4]{R_H(7D)})^8 + (n \sqrt[4]{l_\gamma})^8 + (n \sqrt[4]{l_P/l_p})^8 + (\Omega_b^{-1} \sqrt[4]{26})^{-1} + \exp - (10 \sin 2\theta_{13})^2 = 240$$

$$8. (l_P^2(7D) + R_H^2(7D) + l_\gamma^2) - \pi R_S(26) \cong \left(24^2 / \cos(2\pi / \sum_{F_n/240} F_n) \right)^{-1}$$

$$9. \left[l_P^2(7D) + R_H^2(7D) + l_\gamma^2 + \pi^2 - \frac{l_\gamma^2}{(l_P(26) + R_H(26))^2} \right] / \sin(2\theta_{13}) \cong 120$$

$$10. 10/(\varphi^3 + 2) \cong \sqrt[4]{l_p(26)}$$

Monstrous moonshine

$$j(\tau) = \frac{1}{q} + 744 + 196884q + 21493760q^2 + 864299970q^3 + \dots$$

where $q = \exp(2\pi i\tau)$, and

$$1 = 1$$

$$196884 = 196883 + 1$$

$$21493760 = 21296876 + 196883 + 1$$

$$864299970 = 842609326 + 21296876 + 2 \cdot 196883 + 2 \cdot 1$$

⋮

- $\left(l_P^3(26) \exp(l_p(26)) / \sqrt{\ln(l_\gamma)} \right) + 2\pi = 196884.00169004$

- a) $\left(l_P^3(26) \exp(l_p(26)) / \sqrt{\ln(l_\gamma)} \right) + 2\pi - \left[(\alpha^{-1} / \ln^2 \varphi) - 1 / (\ln 247040 + [\dim(SU(8)) + \ln 247040]^{-1/2}) \right]^{-1} = 196884$, $\varphi =$
golden ratio

- b) $\left(l_P^3(26) \exp(l_p(26)) / \sqrt{\ln(l_\gamma)} \right) + 2\pi - \left[\tan(2\pi / \sum_{F_n/240} F_n) + 24 \right]^{-2} = 196884$

- $744 \cong \exp(l_P(26)) - \frac{\sqrt{-\ln(\sin^2 2\theta_{13}) + 1}}{\sqrt{l_P^2(26) + R_H^2(26)}} = 743.99999497123$

- $744 \cong \exp(l_P(26)) - \frac{\sqrt[3]{26} + 1}{\sqrt{l_P^2(26) + R_H^2(26)}} = 743.999987535805$

- $\exp(l_P(26)) - \frac{\sqrt[3]{26} + 1}{\sqrt{l_P^2(26) + R_H^2(26)}} + \left(\frac{m(V_H)}{6m_e} - \frac{\exp(l_P(26))}{6 \sqrt[4]{l_P(26)}} \right)^{-1} = 744.000000000001$

- $744 = (5! = 120) + (624 = (\sum_{F_n/240} F_n^2)6 = \dim[SU(25)])$
- $\dim[SU(25)] = 24 \cdot 26 = 5^4 - 1$
- $11D = 8D(\text{octonions}) + 3D(\text{cuaternions} - 1) = 7D(\text{octonions} - 1) + 4D(\text{cuaternions})$ $8D \cdot 3D = 24D$, $7D \cdot 4D = 28D$, $(8D \cdot 3D) + (7D \cdot 4D) = 52D = \dim(F4) = (\sum_{F_n/240} F_n^2)/2$
- $[(8D \cdot 3D) + (7D \cdot 4D)]/2 = \sum_{26} (i1)^4 = 26$

Monster Group

- Sum of the exponents of the primes dividing the order Monster group: 95

$$l_P^2(26) + R_H^2(26) + \pi^2 - 1 / [l_P(26) + R_H(26) + R_H(7D) / \tan(6\pi / \sum_{F_n/240} F_n)] = 95.0000000889041$$

- $O_r(M) =$ Order Monster group
- $(\sum_{p/O_r(M)} \sqrt[4]{p}) = 31.1587231903925$, $8(\sum_{p/O_r(M)} \sqrt[4]{p}) \cong \dim(E8) + (1 + \sin \theta_w(GUT))^2$
- Mathieu group M11, Order = $11!/7!$. Maximal subgroups of M11: M10 = A6.23, Or = 720 ; L2(11), Or = 660 ; M9:2 , Or = 144 ; S5, Or = 120 ; 2S4, Or = 48
- $O_r(M11) = 7920 \cong [(247040 = \dim \text{real}^2(E8) + 32^2) + (\ln 8 - 1)^8] / (\sum_{p/O_r(M)} \sqrt[4]{p}) - \ln(\sum_{n=1}^{24} n^2) = 7920.0000078599$
- $(\sum_{p/O_r(M)} \sqrt[4]{p}) + (\sum_{F_n/240} \sqrt[4]{F_n}) + [(l_\gamma - R_H(7D))^{-1} - 2] / O_r(M11) = \ln[m_p / (\sin(2\pi / \sum_{F_n/240} F_n) + 1)m_H]$

The 26 dimensions do not appear directly. The same way that the 8 dimensions correspond to the possible states of polarization of the photon in 3 dimensions; so same the 26 dimensions are generable by variations with repetition of three dimensions, taken from 3 to 3. The reason for the reduction of the 26 dimensions to 11, is its reduction by the matrix of the 4 bosons Higgs?, by the group SU(4) and the impossibility of that photons can adopt more than 2 polarization states; which prevents the direct manifestation of $3^3 - 1$

This result is not incompatible with the generation of the 26 dimensions, obtained in section 3.1.5.1

Negative values of the squares of the octonions and quaternions, result in the product matrix 21, which when added to the 5 possible states of the spins, satisfies the equality $3^3 - 1 = 26 = 21 + 5$. The 4 Higgs bosons?, and the spins must have a direct relationship with the group SU(4), which is the only one that can reduce the dimension from 26 to 11, with $26 - \dim [SU(4)]$

$$\text{And: } 3^3 + 2^3 = \dim[SU(6)] = \left(\sqrt{\sum_{n=1}^{24} n^2} / 2 \right) , 3^3 - 1 + 2^3 = F_7 + F_8 , F_7 F_8 + 1 = 2 \cdot 137$$

4.4 Spines, torus, colors and supersymmetry

This section will demonstrate how the spins, the supersymmetry and the theorem of toric colored surfaces of genus g , are directly related to the introduction of several assumptions consistent with the quantum theory.

One result is that the application of some techniques of LQG theory are naturally incorporated.

A torus of 7 dimensions can be generated, as has been shown, by the application of the squares of the imaginaries of the octonions, causing it to curve 7 times in a mixture state; for example: choosing the dimensions x, y ; and obtaining 7 curls with negative internal curvature by applying the operation: e_1^2xy, \dots, e_7^2xy

4.4.1 The supersymmetry

The rules involve three basic operations supersymmetry transformation of fermions into bosons:

$$1/2_s - 1/2_s = 0_s ; 1_s - 1/2_s = 1/2_s ; 2_s - 1/2_s = 3/2_s$$

These are the states of transformation of fermions on bosons.

We believe that a unified theory, is based on the existence of a single superparticle which contains in itself all the characteristics of symmetry, spins, groups, etc. that the rest of particles generated by instability own of the superparticle. It could also be interpreted, perhaps, as the expansion produced by a black hole that emits its energy as photons. It has been shown in previous chapters and in fact, the mass-energy are nothing but configurations and topological transformations of spatial dimensions and time dimension along with the movement occurs, and therefore allows any geometric-topological transformation.

The origin of the universe is not that arose with an amount of energy equivalent to the current universe, if not the indistinguishability of space-time-energy when there was not any breaking of symmetry, and therefore, decay to lower levels of energy states allowed by the instability mentioned above, the expansion of this superparticle-torus, breaking the outer surface and in a very short time, as created space, this space emptied their topological configurations -geometric and led to the currently existing mass-energy. The residue of the drain d dimensional spacetime, produced our four-dimensional spacetime, as well as the value of the vacuum (cosmological).

The torus surface ripped, open, and emptied as was expanding energy (to create space for expansion), decreased its negative curvature to finish closing on a sphere, the point where it ended inflation. Necessarily and naturally must meet the formula (11).

Superparticle If supersymmetry is real and exists necessarily all spins must be incorporated in this superparticle as a mixture of states, or different configurations, according to consistent rules with quantum theory.

These rules could be:

1. The statistics of fermions and bosons should require that the spins of fermions and bosons are separated. If so does not happen atraci3n force that tends to congregate bosonic would produce instability. The same way the repulsive force of the fermions would produce instability. In short: For the superparticle is sufficiently stable for some time, it is necessary that

fermionic and bosonic spins be separated by to avoid instability. Although this argument is debatable, it seems that is true, as shown below.

2. The spins must incorporate the three basic operations to exchange of fermions bosons of supersymmetry.
3. The sum of the modules must be different spins, which constitute a differentiated state and you may assign a "color" different. The square of the spin module can be considered a surface.
4. If all states were equal, differences in curvature of these states, using the LQG, or its inverse, the difference in areas between states, seems to imply zero instability. By contrast, an asymmetry produced areas of differences, or differences in surface roughness seems appropriate to generate an instability that results in an expansion.
5. As the spin angular momentum, vibration and have dimension L^2T^{-1} ; necessarily the spins must settle at the toric surface, making this acquires an oscillatory motion-vibratory. This oscillatory motion allows oscillation of the length $l_P(7D) \iff l_\gamma$
6. As a result of Section 4, the location of the spins on the surface, and being the states of undetermined spin, except for any values of its projection on the z axis as a convention, then necessarily these states are spin projections of the spins.
7. The number of possible configurations must be exactly the amount of particle-antiparticle vacuum: 240
8. The spins can also be on the inner surface of the torus.

4.4.2 The theorem coloration of orientable surfaces

This theorem specifies the minimum amount needed to color an orientable surface, so that no region of the surface with a common border with the same color. The expression that calculates the minimum amount of colors is:

$$n_c = \lfloor (7 + \sqrt{1 + 48g})/2 \rfloor \quad (43)$$

The three-dimensional torus with $g = 1$ requires 7 colors. And this configuration allows us to incorporate supersymmetry and all mixtures of spin projections if split-torus surface with $g = 1$, with 7 colored triangulations different, adding the neutral color (or not color) that will correspond to 4 bosons of spin 0. The extension will triangulations in the plane of a tetrahedron, the spins being represented in each of 4 triangles that meet at a common point, and a fourth spin represented by the height of the tetrahedron which meets at the same point that the 3 above.

If you perform the equivalence of the investment anti-colors sign from + to - through investment of time, resulting in a shift equivalence of matter to antimatter. Therefore, we postulate the existence of the anti-colors. Counting, that colors or triangulations of spins can exist in the outer surface and inner torus and with the anti-colors, there are total 32 states.

The tetrahedron triangulations of spins and operation of supersymmetry The tetrahedron has a number of features that appear to be closely linked with the structure of the vacuum and spins. Some of these characteristics, are the following:

1. The amount of isometries of the tetrahedron form a group structure equivalent in size to the group $SU(5)$. $dim[SU(5)] = 24 = 4!$
2. The four faces of the tetrahedron are equivalent the close of the three planes of the three dimensions by a fourth dimension. Permutations of the four sides of the tetrahedron are equivalent to the total isometries of the tetrahedron, also equivalent to the dimensional states mixture of four dimensions by their permutations, 24
3. Counting internal and external surfaces of the tetrahedron and applying the permutations of these surfaces, you get forty-eight states, $24 + 24$. $24 + 24 = dim[SU(7)]$
4. The eight colors would be isomorphic, also, the number of faces of the tetrahedron, internal and external, for their surfaces.
5. 5 are the spins.
6. If for each spin, with its corresponding value, forms a tetrahedron of side equal to s ; is calculated the height of this tetrahedron and with this heights, one for each spin-tetrahedral, becomes the vector sum of a 5 dimensional sphere, we obtain this equality: $h(s) = s\sqrt{6}/3$

$$\sum_s h^2(s) = \sum_s s ; [((1/2)\sqrt{6}/3)^2 + ((1)\sqrt{6}/3)^2 + ((3/2)\sqrt{6}/3)^2 + ((2)\sqrt{6}/3)^2 + ((0)\sqrt{6}/3)^2 = (1/2) + 1 + (3/2) + 2 + 0$$

7. The amount of standar Model particles until the rank of the Higgs boson mass, counting the triplicity of quarks by the 3 colors, looks like it could be 40 particles, equal to the amount of hyperspheres maximally compactable and touching each other in a 5-dimensional space.

8. The module of any spin, followed by a general formula that depends on the groups $U(1)$, $SU(2)$, $SU(3)$, $SU(4)$ and $SU(5)$: $(dim[SU(n)] - 1)/4 = s(s + 1) = (n^2 - 1)/2$

9. The sum of the cartesian coordinates of a sphere of 4 dimensions, without the spin 0, which coincide with the spins, holds: $\sum_{s \neq 0} s^2 = (1^2 + 2^2 + 3^2 + 4^2)/4$; coordinates sphere arithmetic sum. $(l_p^2(7D) + R_H^2(7D) + l^2\gamma + 1^2)/4 \cong \sum_s s^2$

10. The "matrix" given by: $(\sum_s s)(\sum_s s) = [\sum_s s(s + 1)]/2 = dim[SU(5)]/2 = 26/2 - 1/2$

$$(\sum_s s)(\sum_s s) = [\sum_s s(s + 1)]/2 = (\sum_s h^2(s))^2$$

11. It is likely that the number of faces, edges and vertices of the tetrahedron, as well as its two angles, angles between face and side and the dihedral angle, have a very close relationship not only with the structure of the vacuum, but also with the groups $SU(3)$, $SU(2)$ and $U(1)$ Eight-faces, internal more external $\Leftrightarrow SU(3)$

Six sides of the tetrahedron $\Leftrightarrow 1e + 1\mu + 1\tau + 3\nu \Leftrightarrow 6$ quarks

Three sides of a triangle of the tetrahedron $\Leftrightarrow 1e + 1\mu + 1\tau \Leftrightarrow 3\nu$

Four faces/vertex of tetrahedron: $\Leftrightarrow 1w_+ + 1w_- + 1z + 1\gamma \Leftrightarrow 1H + 1H + 1H + 1H \Leftrightarrow 4D \Leftrightarrow$ Four non - zero spin \Leftrightarrow

$$\dim[SU(2)] + \dim[U(1)]$$

The operation of supersymmetry can be done with the sides of a tetrahedron, and taking two adjacent sides, assigning the spins 2 and 1, according to the following formulas, (equivalent to the figure below): $s = 1$; $s = 1/2 = 1 \cdot \cos(2\pi/6)$; $s = 2$; $s = 3/2 = 2 \cdot \sin^2(2\pi/6)$

Repeating the above process for possible combinations of 2 contiguous sides, 6 sides of the tetrahedron gives exactly the total amount of the sum of all projections of the spins, if one includes the height of tetrahedron that generates 3 combinations with 3 sides.

For point 3, above, has for forty eight states:

$$\sum_s h^2(s) = \sum_s s \quad ; \quad 48 \sum_s s = 240 \quad ; \quad 240 = \dim[SU(7)] \sum_s s = \dim[SU(7)] \sum_s h^2(s)$$

The above equation shows the direct relationship, again, between the amount of particles of the vacuum and certain surfaces, and how are you take internal and external surfaces.

Obtaining the 120 particles of the vacuum, without the antimatter can be performed as a function of the sum of squared modules of the spins, depending on the angle of coupling due to supersymmetry, sixty particles, plus their sixty super-partners.

Sum of the divisors of the twenty-four permutations of the four faces of the tetrahedron is equal to sixty. And applying point 3 : $2 \sum_{d/24} d = 60 \text{ particles} + 60 \text{ s - particles}$

$$[\sum_s s(s+1)] / \sin(2\pi/60) + 2^{-2} + 3^{-2} + 5^{-2} + 8^{-2} = 120.001389... \cong 120 + (24[l_P^2(7D) + R_H^2(7D) + l_\gamma^2 + 1^2])^{-1} \cong 120$$

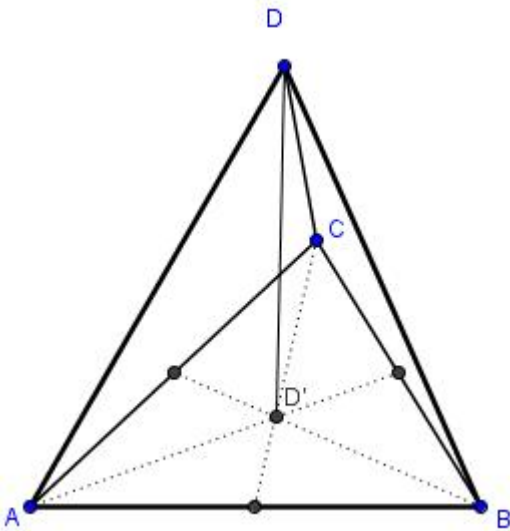

The sum of the 6 sides of the tetrahedron plus the height vector (7) are isomorphic to the amount of colors for a torus with $g = 1$

Other very clarifying relationships are as follows:

1. $\exp[l_P(26)]/60 + 1/(10 \sin 2\theta_{13})^2 = 12.50014818 \cong 25/2 = \sum_s s(s+1)$

2. $26 \sin \hat{\theta}(m_Z)(\overline{MS}) = 12.50056638 \cong 25/2 = \sum_s s(s+1)$; $\sin \hat{\theta}(m_Z)(\overline{MS}) = 0.23116$

3. $\exp[l_P(26)]/60 + 1/2 \ln(m_p/m_H) \cong \ln(m_H/m_e)$

4. $\ln^{-1}(60) \cong l_\gamma - l_p(7D)$

5. Considering the toroidal surface dependent seven dimensional lengths calculated, and the seven compactifications, and the sixty particles or sixty s-particles: $7[l_p(7D)R_H(7D)4\pi^2 - \left(\frac{l_p^2}{l_p^2} 8 \ln 2 \sum_s \sqrt{s(s+1)}/\sqrt{3}\right)]/60 - \Omega_b \cong \ln(m_p/m_H)$;

$$7[l_p(7D)R_H(7D)4\pi^2 - \left(\frac{l_p^2}{l_p^2} 8 \ln 2 \sum_s \sqrt{s(s+1)}/\sqrt{3}\right)] \cong 60[\sin(2\pi/K(5D)) + \dim(E6)/2]$$

6. Dihedral angle of the tetrahedron: $\arccos(1/3) = \theta_{Dthd}$

7. $[\sum_s s(s+1)]/\sin \theta_{Dthd} + \left(2/\sum_{n=1}^{24} n^2\right) = \ln(m(V_H)/m_e)$; $m(V_H) = \text{mass equivalent Higgs vacuum}$

8. Number of colors needed to color a toroidal surface of genus twenty-six: $n_c(g=26) = (7 + \sqrt{48 \cdot 26 + 1})/2$; $n_c(g=26) = 21.1705970470723 \cong (8 \ln 2/\sqrt{3}) \sum_s \sqrt{s(s+1)} - 10 \sin^2(2\theta_{13}) \sin \theta_{13}$; $n_c(g=26) \cong n_c(g=7) + 8 + (\ln 137)/10$; $n_c(g=$

$$26) + (\pi^2/6) - 1 = 21.8155311139205 \cong \Omega_b^{-1} + 1/(2n_c(g=26) - 7)^2$$
 ; $\pi^2/6 = \text{inverse probability that two numbers are coprime}$

9. Tetrahedron: angle between an edge and a face; $\theta_{thd1} \exp[(\sum_s s(s+1)/\sin \theta_{thd1}) - (26/2)]^2 - \sin^{-4} \theta_1 = m_\mu/m_e$ If calcu-

lated the angle of curvature needed to obtain Ω_b^{-1} ; solving the equation: $(l_P(7D) + R_H(7D) \cos \theta_1)R_H(7D) - \Omega_b^{-1} \cos \theta_1 = 0$

Angle is obtained: $\theta_1 = 46.23076128^\circ$; $(\exp[(\sum_s s(s+1)/\tan \theta_{thd1}))/2 + (2^2(2^3 - 1) + \sin(2\pi/\varphi^2)) = m_\tau/m_e$; $4^2 + \sin \theta_{thd1} =$

$$16.8164965809277 \cong m_\tau/m_e$$

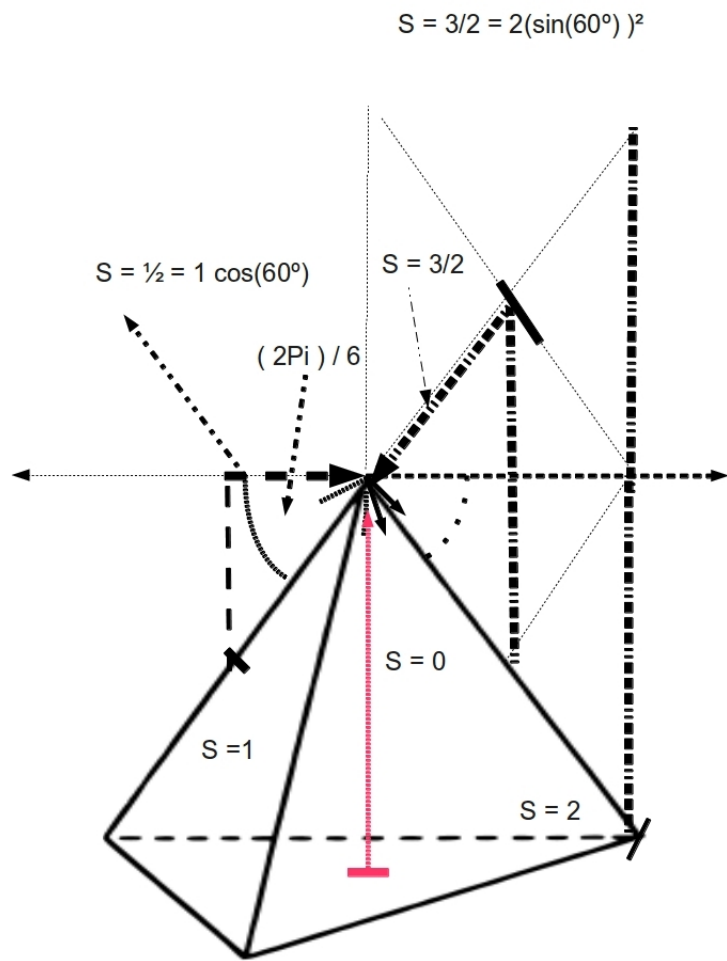

Figure supersymmetry transformation by the tetrahedron

The extension in the plane of the graph in the figure above creates 4 regions that are colourable with 4 colors so that no common border region (spin) has the same color.

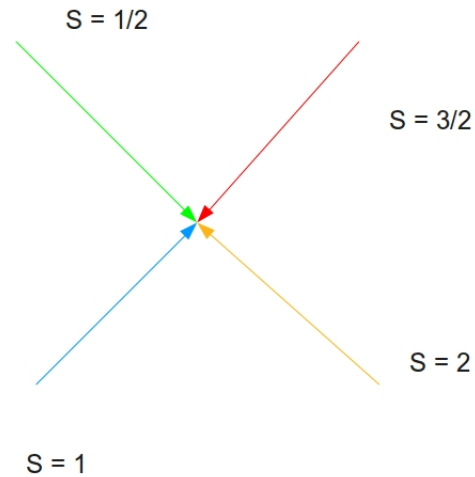

Figure spin tetrahedron graph extension

With these settings you can incorporate supersymmetry and other combinations of spins, with the premise that all-spin triangles have no common border inside (the four color theorem says this imposition). The choice of this geometric figure has a number of features strongly agree with certain symmetries and views, groups and states of the spins.

The following figure shows the arrangement of the spins, and then its extension in the plane, which becomes a graph that can be applied to calculate areas as LQG.

5 of the larger triangles, or "colors" will be the combination of 5 spins taken from 4 by 4.

One of them, as will be seen in the diagram below, incorporates one of the 3 operations supersymmetry. The remaining 2 will be the 2-triangles "colors" of the 2 remaining supersymmetry operations, leaving a neutral triangle without spines. In total 8 different colored triangles, the sum of the modules of the spins. The triangle with 4 spins 0, to fulfill the rule that two spins have no common border will need to remove 2 of them.

The colors of the triangle-triangle incorporate supersymmetry for spin start, another operator for spin 1/2, one for the result or supersymmetric particle and one in the center with spin 0.

To be made larger by 4 triangle equilateral triangles, these will have an angle on each side of $2\pi/6$; $y \cos(2\pi/6) = 1/2$

4.4.3 Schematic of triangulation of the surface of a torus of genus 1 for the implementation of the theorem of colors.

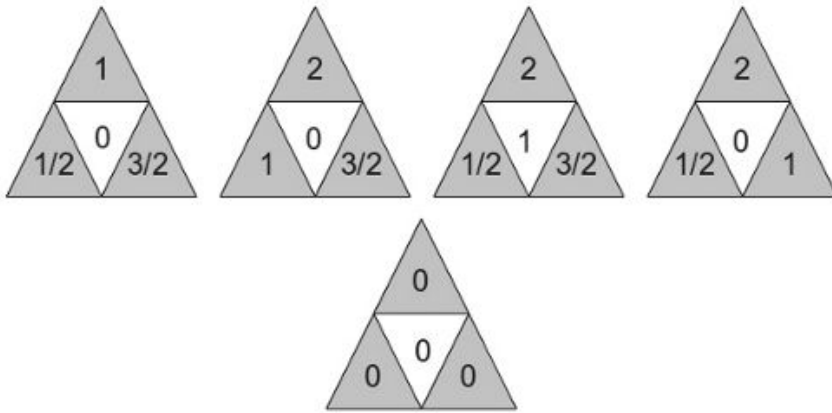
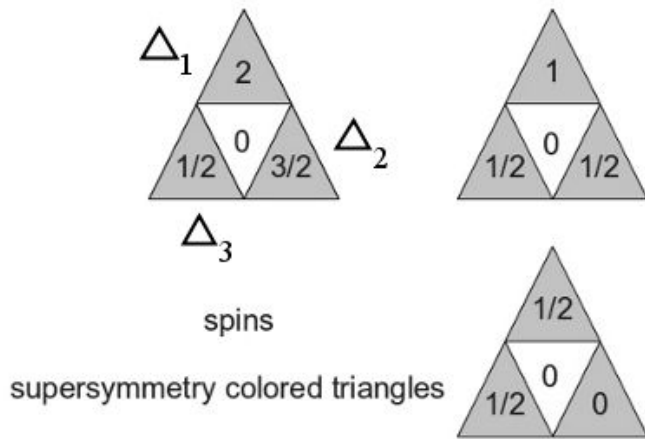

all combinations of spins colored triangles

spins sum modules

$$\sum_s \Delta(\sqrt{s(s+1)})$$

Having discounted 2 spins 0, leaving 30 spins, which allows to locate exactly 2 copies of all possible values of the projections of the spins, including negative values, and therefore incorporate the antimatter, and the total number of projections of the spins is 15, counting the spin projection 0 has a value 0.

4.4.4 Counting the number of particles in the vacuum by the triangulation of spins

There are 2 possibilities for the count: 1) The inner surface of the torus, with negative curvature, also have spin, in which case just enough to take into account the 3D torus with $g = 1$. In this case the number of total particles of the vacuum, counting antimatter, will be: $60 \times 4 = 240$ 2) Without spines on the inner surface of the torus, which implies that you must enclose the 8 torus of the 4 projections torus successive 3D, meaning that again: $30 \times 8 = 240$

$$2^8 - 2^4 = 240$$

For reasons that were clarified later, we favor the first option: on the inner surface there is also spins.

4.4.5 Calculation of baryons antibaryons ratio to the number of photons

Table I of all projections of the spins All projections of the spins, 15, are summarized in the following table:

$s = 2$	-2	-1	0	1	2
$s = 3/2$	-3/2	-1/2	1/2	3/2	
$s = 1$	-1	0	1		
$s = 1/2$	-1/2	1/2			
$s = 0$	0				

Table II of all the projections of the spins of the 8 triangles colors

$\tilde{\Delta}_1$	2	3/2	1/2	0
$\tilde{\Delta}_2$	1	1/2	1/2	0
$\tilde{\Delta}_3$	1/2	1/2	0	0
Δ_4	1	3/2	1/2	0
Δ_5	2	3/2	1	0
Δ_6	2	3/2	1/2	1
Δ_7	2	1	1/2	0
Δ_8	0	0		

In total, this matrix has 30 projections of spins, which allows us to include projections of the spins of their antiparticles. Noting that the amount of projections of table II is twice of Table I, for the spins; 2, 3/2, 1/2, and there is an asymmetry for the spin 1 and spin 0, the triangle 8 is considered neutral because it has no spin fermion or boson. The spin asymmetry of 1: 4 spins Table I, $|(4 \times 2) - 5 = 3|$

The asymmetry of spin 0: 3 spins table I, $|(3 \times 2) - 8 = 2|$; $(\Delta_8 \rightarrow 1s_0 ; \sum_{s=0} \sqrt{s(s+1)} = 0)$

Now on the Table II apply the time reversal operation for all spins, keeping the 2 states: matter and antimatter. This will involve negative return half of the spins 2, 1/2 and 3/2. For the spin 1, can only be do this for four of the spins 1, leaving one without mating. The spin 0, since the vector sum: $0 + 0 = 0 - 0$; its final value did not change.

$$T |p, s_z, c \rangle \propto | -p, -s_z, c \rangle$$

This time reversal operation can be considered equivalent to change colors, anti-colors, and the latter would change the sign from + to - projections of the spins.

The resulting operation will offer the following final state:

$\tilde{\Delta}_1$	-2	-3/2	1/2	0
$\tilde{\Delta}_2$	-1	-1/2	1/2	0
$\tilde{\Delta}_3$	-1/2	1/2	0	0
Δ_4	1	-3/2	-1/2	0
Δ_5	2	3/2	-1	0
Δ_6	-2	3/2	-1/2	1
Δ_7	2	1	1/2	0
Δ_8	0	0		

And finally the total count: $\tilde{\Delta}_1 + \tilde{\Delta}_2 + \tilde{\Delta}_3 + \Delta_4 + \Delta_5 + \Delta_6 + \Delta_7 = 4s_0 + 4s_0 + 1s_1 = 8s_0 + 1s_1$

If we admit the existence of the same configuration of triangulations of projections of spins within the inner surface of the torus, then performing the same process, it will have for the inner and outer surfaces a total amount:

$$4s_0 + 4s_0 + 4s_0 + 4s_0 + 1s_1 + 1s_1 = 2^2s_0 + 2^2s_0 + 2^2s_0 + 2^2s_0 + 1^2s_1 + 1^2s_1 = 18$$

This result shows the sum for the 2 surfaces, external and internal, are the cartesian coordinates of a sphere of 6 dimensions. The reverse is the curvature of the field. 18 are because the amount of particles that asymmetric process occurs. This process is equivalent to do on the inner surface with negative curvature produced by compacting a dimension by $(ix)^2$; operation by adding the temporary investment bend time $(ict)^2 = t \cdot -t$

Of this form, you get the same amount, 18, as sum of the coordinates of a 6 dimensional sphere, being the inverse of this quantity of particles a curvature, but in this case must be negative and must necessarily correspond to a value almost exact to the curvature of the inner surface of the torus with an angle θ_{13} , $R_H(7D)$, $l_P(7D)$

If calculated the curvature of the inner surface of this torus, we obtain: $K_c(7D) = -\cos \theta_{13} / (l_P(7D) + R_H(7D) \cos \theta_{13}) R_H(7D)$

$$K_c(7D) = -1/17.9095625109294 ; -1/(2^2s_0 + 2^2s_0 + 2^2s_0 + 2^2s_0 + 1^2s_1 + 1^2s_1) \approx K_c(7D)$$

$K_c(7D)$; represents, then, the curvature due to the baryon asymmetry, which corresponds to densification or compactification of dimensions, ie: the nonzero mass. Nonzero mass and dimensions compactification are equivalents.

In section 3.1.2 and by (12) was obtained after breaking the symmetry of the vacuum (240), some baryonic (electrons) as:

$$2 \ln\left(\frac{m_p}{m_e}\right) = 103.05568214477 ; \text{ and some photonic } \alpha^{-1} = 137.035999084$$

Can we think that the fractional parts of the baryonic and photonic are curvatures?. Yes, if we admit the existence of anti-colors, and the 6 dimensions we have the group SU(6) with dimension 35, and the group U(1) of electromagnetism.

With these elements we have:

$$l_P^2(7D) + R_H^2(7D) + l^2\gamma + 1^2 = 29.999284308147; (28) \quad l_P^2(7D) + R_H^2(7D) + l^2\gamma + 1^2 - (\alpha^{-1} - 137)^{-1} = \dim[U(1)] + 1.220799722261$$

$$(l_P^2(7D) + R_H^2(7D) + l^2\gamma + 1^2 - (\alpha^{-1} - 137)^{-1} - \dim[U(1)])^{-1} + \dim[SU(6)] = 2 |K_c^{-1}(7D)| \quad (44)$$

This result suggests that the center of the torus is dominated by a photonic spherical configuration, and therefore, presumably electric charge, which repels the ring (for this reason curve dimensions), suggesting that an electric charge has the same sign. Likewise, there is indication that the central dimensions of the torus may be not compactified, 4D

The result of (41) seems to confirm the existence of the anti-colors.

For the fractional part of the baryonic part of breaking the vacuum by (28), must be met:

$$2 \ln\left(\frac{m_p}{m_e}\right) = 103.05568214477 ; \left(2 \ln\left(\frac{m_p}{m_e}\right) - 103\right)^{-1} \cong |K_c^{-1}(7D)| / \cos^4(\theta_{13} \sin \theta_c) \cong |K_c^{-1}(7D)| + \sin^4 \theta_W$$

$$|K_c^{-1}(7D)| ; \text{ is a value of minimum asymmetry, and therefore can be considered as a differential.}$$

The fact that either a minimum is checked by the following inequality:

$$(240.09168122877 - 240)/2 = 0.045840614385 = \Omega_b \quad (14) \quad |K_c^{-1}(7D)| < 1/\Omega_b$$

It thus has a differential minimum for matter antimatter asymmetry, which is equal to an internal angle dependent curvature of the torus; and this curvature is, specifically for a given value, its maximum, the value of the baryonic density of the universe.

If calculated the angle of curvature needed to obtain Ω_b^{-1} ; solving the equation: $(l_P(7D) + R_H(7D) \cos \theta_1) R_H(7D) - \Omega_b^{-1} \cos \theta_1 = 0$

Angle is obtained: $\theta_1 = 46.23076128^\circ$; a value very close to $360/8 = 45^\circ$

This angle seems to have a definite relation to the tetrahedron (supersymmetry, colors), it can be expressed as a function of the Weinberg angle of unification, the GUT scale.

Tetrahedron: Angle between an edge and a face (θ_{thd1}). Height; For a regular tetrahedron of edge length a: $(H = (\sqrt{6}/3)a)$. $(\sqrt{6}/3) = \sin \theta_{thd1}$

Radius of circumsphere: $R = (3/8)a$; $3/8 = \sin^2 \theta_w(GUT)$

$$\theta_1 \cong \theta_w(GUT) / \sin \theta_{thd1} ; \theta_w(GUT) = 37.7612439070351^\circ ; 37.7612439070351^\circ / \sin \theta_{thd1} = 46.24788...$$

This angle has a curious property: $r = 1$; $\theta_1 = 2\pi / [(\sqrt{240 + r^{10}\pi^5/120})/2]$; where $r^{10}\pi^5/120$ is the volume of a sphere 10 D with unit radius.

Interpretation of the formula for area of LQG theory If the existence of the 8 colors, applied to the tetrahedral triangulations that have been shown, is consistent with LQG theory, then the area could be interpreted as LQG, given by $(8\pi \ln 2l^2 \sum_s \sqrt{s(s+1)})/\pi\sqrt{3}$; as circular type areas multiplied by the 8 colors, with a deformation factor.

These surface roughnesses of the surface of torus, asymmetrical, would be the causative late instability thereof and also, perhaps, the origin of the inflation-expansion of the superparticle torus. Results very indicative of the possible reality of this conjecture that involve the lengths 7D which have been calculated, are the following:

1. Relationship between the torus area, depending on $R_H(7D)$, $l_P(7D)$, the circular area $\pi R_H^2(7D)$, and 13 colors needed to color a torus of genus 8: $13\pi R_H^2(7D) \cong 4\pi^2 R_H(7D)l_P(7D)$ $13 = \lfloor (7 + \sqrt{48 \cdot 8 + 1})/2 \rfloor$
2. Unlike average radius of circular areas: $\sqrt{[\pi r^2(\alpha^{-1}) - \pi R_H^2(7D)]/2} = \ln(m_P/m_v) - (\alpha^{-1}/2)$

Now proceed to the final calculation of the objective of this section.

Assuming an initial symmetry of baryons antibaryons which degenerated into an asymmetry by subsequent decay processes, and assuming an inflation expansion type black hole with massive emission of photons, then, at first the number of photons and baryons was exactly the same as the process $\gamma \rightarrow b + \bar{b}$

Since the matter antimatter asymmetry has been shown to genre baryonic density according (14), then it holds that before the matter antimatter symmetry breaking: $n(\gamma) = n(b) = n(\bar{b})$

Subsequently the matter antimatter symmetry breaking for the amount Ω_b of baryons, corresponds to a photon, being $-d(\Omega_b^{-1}) = d(n(\bar{b}) - n(b))$

Therefore can establish: $-d(\Omega_b^{-1})/\Omega_b^{-1} = d(n(\bar{b}) - n(b))/n(\gamma) = -\Omega_b^{-1}/1\gamma$

$$\int -d(\Omega_b^{-1})/\Omega_b^{-1} = -\Omega_b^{-1} + C = -\ln[(n(\bar{b}) - n(b))/n(\gamma)]$$

$$\exp -(\Omega_b^{-1}) \cdot C = (n(b) - n(\bar{b}))/n(\gamma)$$

And, surprisingly, it holds that the constant C is equal to: $\sqrt{[\pi r^2(\alpha^{-1}) - \pi R_H^2(7D)]/2}$

$$\text{Finally: } \exp -(\Omega_b^{-1}) \cdot \sqrt{[\pi r^2(\alpha^{-1}) - \pi R_H^2(7D)]/2} = (n(b) - n(\bar{b}))/n(\gamma) \cong 6.2 \times 10^{-10} \quad (45)$$

4.4.6 Calculation of the sum of modules of the spins of the 8-color triangles.

The sum of all modules equivalent to those 8 colors shall be as follows:

$$\sum_{\tilde{S}} \Delta \sqrt{s(s+1)} = \sum_{S=\{2, 1/2, 3/2\}} \Delta \sqrt{s(s+1)} + \sum_{S=\{1, 1/2, 1/2\}} \Delta \sqrt{s(s+1)} + \sum_{S=\{0, 1/2, 1/2\}} \Delta \sqrt{s(s+1)}$$

$$\sum_S \binom{5}{4} \Delta \sqrt{s(s+1)} - \sum_{S=\{2, 1/2, 3/2\}} \Delta \sqrt{s(s+1)}$$

$$\sum_{c=1}^8 \Delta_c \sqrt{s(s+1)} = \sum_{\tilde{S}} \Delta \sqrt{s(s+1)} + \sum_S \binom{5}{4} \Delta \sqrt{s(s+1)} - \sum_{S=\{2, 1/2, 3/2\}} \Delta \sqrt{s(s+1)} = 31.5431967056885$$

Where $\sum_{\tilde{S}} \Delta \sqrt{s(s+1)}$; is the sum of the modules of the spins for the three triangles of supersymmetry.

Observations on the possible connections of this sum of modules of the spins. 8 x 4 tetrahedral color triangles inside triangles: 2^5

Sum of the amount of all projections of all the spins (15), minus the zero projection of spin 0.

$$14 = \left(\sum_{c=1}^8 \Delta_c \sqrt{s(s+1)} \right) / \sqrt[4]{26} + \left[(8 \ln 2 / \sqrt{3}) \sum_{\tilde{S}} \Delta \sqrt{s(s+1)} \right]^{-1} = \dim(G2)$$

Formula :

$$l_P^2(7D) + R_H^2(7D) + l^2\gamma + l_P^2(x) + l_P(y) + l_P^2(z) + l_P^2(ct) + 2^2 + 2^2 + 2^2 + 2^2 = 48.999284308147$$

$$\sum_{n=1}^{11} l_n^2 = l_P^2(7D) + R_H^2(7D) + l^2\gamma + l_P^2(x) + l_P(y) + l_P^2(z) + l_P^2(ct) + 2^2 + 2^2 + 2^2 + 2^2$$

$$40^2 - [\ln(m_H/m_e) = 39.110535526566]^2 = 70.36601082522 = \ln(m_P/m_v)$$

Application area according to LQG

$$\left(8 \ln 2 \sum_{c=1}^8 \Delta_c \sqrt{s(s+1)} / \sqrt{3} \right) \sum_{n=1}^{11} l_n^2 \cong \left(40^2 - [\ln(m_H/m_e) = 39.110535526566]^2 \right)^2 \cos^2(2\pi/248)$$

1. This sum of modules of all the configurations shown in the figure, multiplied by 8/2, which would correspond to the projection at once, the three-dimensional torus $g = 2$, which would generate a 4 dimensional torus $g = 4$; would give the following surface with a unit length equal to l_P/l_P :

$$S = 1^2 \cdot 4 \sum_{c=1}^8 \Delta_c \sqrt{s(s+1)} \cong 120 / \sin(2\pi/5)$$

The angle is a function of the 5 spins. Discounting the spins 0, no color and a single spin of the fourth central triangle, non-zero (spin 1), it has 21 non-zero spin. $21 = (-7) (-3)$

$$21 = -7 \times -3 = [\Omega_b^{-1}] = 2 \cdot 11D - 1 = \dim[SO(7)]$$

Where the equivalent mass of the Higgs vacuum and the Higgs boson mass lighter and neutral have been normalized to the mass of the electron.

$$m(V_H) = 481842.934 ; m_H = 247040$$

$$2. \sin(2\pi/5) \cdot 1^2 \cdot \sum_{c=1}^8 \Delta_c \sqrt{s(s+1)} = 29.999362771725 \cong l_P^2(7D) + R_H^2(7D) + l^2\gamma + 1^2 = 29.999284308147$$

3. The sum of the spin module multiplied by the 4 x 2, to fill the vacuum with 240 particle antiparticle pairs:

$$\sin(2\pi/5) \cdot 1^2 \cdot 8 \sum_{c=1}^8 \Delta_c \sqrt{s(s+1)} = 240 - \exp - \left(10 [\tan^2(3\pi/10)]^{-1} \right)$$

$$4. \sin(2\pi/5) \cdot 1^2 \cdot 2 \sum_{c=1}^8 \Delta_c \sqrt{s(s+1)} \cong 2(l_P^2(7D) + R_H^2(7D) + l^2\gamma + 1^2)$$

5. Applying the formula of the area by LQG theory:

$$\sqrt{3} \left(8 \ln 2 \cdot 1^2 \cdot \sum_{c=1}^8 \Delta_c \sqrt{s(s+1)} / \sqrt{3} \right) + \cos \hat{\theta}(m_Z)(\overline{MS}) \cong \ln^2(m(V_H) \sqrt[4]{2} / m_e)$$

$$6. \left(8 \ln^2 2 \cdot 1^2 \cdot \sum_{c=1}^8 \Delta_c \sqrt{s(s+1)} / \sqrt{3} \right) + 1/\sqrt{26} \left(8 \ln 2 \cdot 1^2 \cdot \sum_{c=1}^8 \Delta_c \sqrt{s(s+1)} / \sqrt{3} \right) = 70$$

$$\ln^2 2 \cong \sin \hat{\theta}(m_Z)(\overline{MS}) \cong \ln(240) - 5$$

$$\exp -\sqrt[4]{26} \cong \sin^2 2\theta_{13} \cong \sin(2\pi/60)$$

$$7. l_P(26) = l_P(26)/l_p = \left(2(2\pi)^{26} / \left[2\pi^{26/2} / \Gamma(26/2)\right]\right)^{\frac{1}{26+2}} = 6.61240539117563$$

$$l_p^2(26) \left(8 \ln 2 \cdot \sum_{c=1}^8 \Delta_c \sqrt{s(s+1)} / \sqrt{3}\right) \cong (l_p^4(7D) - 10)^2$$

8. 8-color triangles tetrahedral x 4 interior triangles: 2^5

$$R_H^2(7D) \left(8 \ln 2 \cdot \sum_{c=1}^8 \Delta_c \sqrt{s(s+1)} / \sqrt{3}\right) \sin(2\pi/32) \cong \ln^2 \left(m(V_H) / \cos^2(2\pi/32) m_e\right)$$

$$9. \left(\sum_{c=1}^8 \Delta_c \sqrt{s(s+1)}\right) / \sin(2\pi/32) \cong \ln^2 \left([m_W + m_Z] \cos(2\pi/60) / m_e\right)$$

$$10. \left(8 \ln 2 \cdot \sum_{c=1}^8 \Delta_c \sqrt{s(s+1)} / \sqrt{3}\right) / \dim[SU(3)]^{\sqrt[4]{5}} = \alpha_s^{-1}(m_Z) \cong (0.1184)^{-1}$$

$$11. \left(8 \ln 2 \cdot \sum_{c=1}^8 \Delta_c \sqrt{s(s+1)} / \sqrt{3}\right) + \sum_{c=1}^8 \Delta_c \sqrt{s(s+1)} \cos^2 \theta_{13} = \alpha^{-1}(m_z) = 128.968$$

$$12. \sum_{c=1}^8 \Delta_c \sqrt{s(s+1)} + \cos^{-4} \theta_w \cong \ln(m_{GUT}/m_Z)$$

$$13. \sum_{c=1}^8 \Delta_c \sqrt{s(s+1)} \cong 32 \cos \theta_{13} - (32 + \sin^{-2}[2\theta_{13}])^{-1}$$

14 The equivalence with the term -3p of general relativity.

$$3 \ln 2 \left(8 \ln 2 \cdot \sum_{c=1}^8 \Delta_c \sqrt{s(s+1)} / \sqrt{3}\right) + \exp -(\sin^{-1}(2\pi/32)) = 3 \times 70$$

15. Electroweak effective angle

$$\sin_{eff}^2 \theta_w(m_Z) \cong 0.23146 ; (2 + \sin_{eff}^2 \theta_w(m_Z)) \sum_{c=1}^8 \Delta_c \sqrt{s(s+1)} \cong 70 + (\sqrt{3/20}) \cong \ln(m_P/m_v) \rightarrow \cong 2.39 \times 10^{-3} eV$$

4.4.7 Unification scale supersymmetry

Area as LQG

$$\left[\left(8 \ln 2 / \sqrt{3}\right) \sum_{\hat{s}} \Delta \sqrt{s(s+1)}\right] / \cos \hat{\theta}_W(\hat{m}_s) \cong (\ln(m_H/m_e) = 39.110535526566) \cos 2\theta_{13} \cong \ln(E_P/E_{\hat{s}})$$

Where E_P ; is the energy of the Planck scale, and $E_{\hat{s}}$; is the energy scale of the supersymmetry.

4.5 Particle in a spherically symmetric potential, the Higgs vacuum, the spins and the change of scale according to equation (11)

The radial potential derived from the solution of the Schrödinger equation:

$$-\frac{\hbar^2}{2m_0 r} \cdot \frac{d^2 u(r)}{dr^2} + V_{eff}(r)u(r) = Eu(r)$$

Which is precisely a Schrödinger equation for the function u(r) with an effective potential given by:

$$V_{eff}(r) = V(r) + \frac{\hbar^2 s(s+1)}{2m_0 r^2}$$

$V(r) = 0$, or solving the vacuum in the basis of spherical harmonics.

$$V_{eff}(r) = \frac{\hbar^2 s(s+1)}{2m_0 r^2}$$

The Higgs vacuum, and specifically the value of the Higgs boson mass of less massive (minimum energy state) to be consistent with a spin value neutral, or zero, necessary for the matter-antimatter symmetry, must be, necessarily a function of the sum of the values of energy due to the sum of these energy values for the values of angular momentum of the spins. The projection, by convention the z axis, of all possible states of the spins for all possible spins, 0, 1/2, 1, 3/2 and 2 should be zero counting antimatter. There are thirty states. A self-interaction of this vacuum that eventually decays to a state of minimum mass, nonzero, electric charged and stable, that is: the electron. This decay must comply with the change of scale, according to equation (11)

The thirty states of matter-antimatter self-interaction of the Higgs vacuum: $30 = 2 \sum_s 2s + 1 = 1^2 + 2^2 + 3^2 + 4^2 \cong l_p^2(7D) + R_H^2(7D) + l_\gamma^2 + 1^2$

$$\text{Energy values by the angular momentum: } V_{eff}(r) = \frac{\hbar^2 s(s+1)}{2m_0 r^2} = E_s = \frac{\hbar^2 s(s+1)}{2m_0 r^2}$$

Isolating the spins, and having a radius of self-interaction $l_p^2/l_p^2 = l_p^2(7D)/l_p^2(7D) = R_H^2(7D)/R_H^2(7D) = l_\gamma^2/l_\gamma^2 = 1$; equation can be written as:

$$s(s+1) = \frac{E_s 2m_0 r^2}{\hbar^2} \quad ; \quad E_s 2m_0 r^2 = (E \cdot t)^2 \quad ; \quad s(s+1) = \frac{E^2 t^2}{\hbar^2}$$

The Heisenberg uncertainty principle states that: $\Delta x \Delta p \geq \frac{\hbar}{2}$; whereby the above equation can be written as:

$$s(s+1) = \frac{(\Delta x \Delta p)^2}{\hbar^2}$$

Performing the sum for all spins, we have: $\sum_s s(s+1) = \sum_{x_1, p_1}^{x_5, p_5} \frac{(\Delta x \Delta p)^2}{\hbar^2}$

The states corresponding to antimatter, or the second solution of Dirac:

$$\sum_s s(s+1)_{(-)} = \sum_{x_1, p_1}^{x_5, p_5} \frac{(\Delta x \Delta p)^2}{\hbar^2} (-) \quad ; \quad \text{And the total sum: } 2 \sum_s s(s+1) = \sum_{x_1, p_1}^{x_5, p_5} \frac{(\Delta x \Delta p)^2}{\hbar^2} + \sum_{x_1, p_1}^{x_5, p_5} \frac{(\Delta x \Delta p)^2}{\hbar^2} (-)$$

Since the Higgs vacuum decays to its minimum energy state with nonzero mass (and stable) and electric charge: the electron. It must meet the equation (11) by changing the scale, so you can see the following equation:

$$\frac{dx^2}{x^2} = \sum_{x_1, p_1}^{x_5, p_5} \frac{(\Delta x \Delta p)^2}{\hbar^2} + \sum_{x_1, p_1}^{x_5, p_5} \frac{(\Delta x \Delta p)^2}{\hbar^2} (-) = 2 \sum_s s(s+1)$$

$$\frac{dx^2}{x^2} = 2 \sum_s s(s+1) = \ln(m_H^2/m_e^2) \quad ; \quad \int \frac{dx^2}{x^2} + C = \ln(m_H^2/m_e^2) = 2 \sum_s s(s+1)$$

$\ln(m_H/m_e) = \sum_s s(s+1) - C/2$; Using Tables V and VII, the number of symmetry between fermions and bosons of the standard model, $12 = 4! / 2$, the constant $C / 2$: $C/2 = 1/\ln(m_Z/m_e)$

So they finally holds: $\ln(m_H/m_e) = \sum_s s(s+1) - 1/\ln(m_Z/m_e) = 12.41730112$

5 The origin of electric charge

Dimensional analysis of electric charge allows express it as: $\sqrt{L^2 T^{-1}}$

A natural dimensionless number arises from the ratio: $\sqrt{\hbar}/e_{+-} = 64.095518722565$

This dimensionless number is quite next to the quantized load factor for the magnetic monopole solution given by Dirac: $\alpha^{-1}/2$

The integer part of $\lfloor \sqrt{\hbar}/e_{+-} = 64.095518722565 \rfloor = 64$; can be generated, if one considers that the curl obtained by the application of the squares of the octonions, is equivalent to a torus 8D, so that for each curl, there is a load with absolute value of 8 units of e (isomorphism with 8 colors).

That is, the 32-spin triangles that make up the eight largest triangles, or colors, it would seem to imply that it should be a sum of electric charges equal to eight.

Dimensional analysis that has shown requires that for a quantized electric charge e, the area or the inverse of a spherical curvature, whether negative or positive; due to 2 possible solutions: $\pm\sqrt{\hbar}/64.095518722565 = \pm e$

The negative electric charge, he notes, it is a topological property direct negative curvature inside the torus. And the positive electric charge is due to the external curvature of the torus.

The set of all possible values of electric charge can be generated for each winding or compactification, dividing the circle compacted in 4 states, corresponding to the quaternions with an angle $\pi/2$ Each state will be the product of the index of state: 1, 2, 3, 4 ; multiplied by the curvature (given by the square of the quaternion of the index of state) elevated to the state index, and dividing the result by the number of states of negative curvature (3 of 3 imaginary square of the quaternions). The complete set will be formed by the sign reversal symmetry for matter antimatter.

Index of each state is isomorphic to each of the four dimensions, in turn isomorphic to the four quaternions.

$$\left\{ + \left\{ (i^2)^1 1/3, (j^2)^2 2/3, (k^2)^3 3/3, (1^2)^4 4/3 \right\} ; - \left\{ (i^2)^1 1/3, (j^2)^2 2/3, (k^2)^3 3/3, (1^2)^4 4/3 \right\} \right\} = \dots,$$

$$\left\{ + \left\{ -1/3, 2/3, -3/3, 4/3 \right\} ; - \left\{ -1/3, 2/3, -3/3, 4/3 \right\} \right\}$$

Again the isomorphism with the number 8

Following the ideas of Section 4.3, and using the octonions, it would generate the integer value of sixty-four, integer part, which corresponds to the ratio between the root of Planck's constant and electric charge.

$$\sum_{n=\epsilon_0}^{\epsilon_7} \left\{ (n^2)^1 1/3, (n^2)^2 2/3, (n^2)^3 3/3, (n^2)^4 4/3 \right\} = S(+ -)$$

Matter: $S(+ -) \rightarrow 8(|3(4/3 + 1/3)| + |3(2/3 - 1/3)| + |-1| + |+1|) = 64$

Antimatter: $\overline{S(+ -)} \rightarrow 8(|3(-4/3 - 1/3)| + |3(-2/3 + 1/3)| + |+1| + |-1|) = 64$

Matter + antimatter : $S(+ -) \cup \overline{S(+ -)} \rightarrow 8(|3(4/3 + 1/3)| + |3(2/3 - 1/3)| + |-1| + |+1|) + 8(|3(-4/3 - 1/3)| + |3(-2/3 + 1/3)| + |+1| + |-1|) = 128$

Possible polarization states of the photon as a function of seven dimensions: $2^7 = 128$

$[\alpha^{-1}] = 2^7 + 2^3 + 2^0$ Seven dimensions compacted, three extended. and zero space-time.

Clearly, the spins are precisely the quantification of the 4 states of rotation by an angle units $\pi/2$, With zero spin, spin equal to 0. $1/2$ rotation, $(1/2 + 1/2)$ spin, $(1/2 + 1/2 + 1/2)$ spin, $(1/2 + 1/2 + 1/2 + 1/2)$ spin; 0 twists.

Later will be observed the importance of the length of circle given by $\pi(\pi/2)$

An electrical charge with absolute value of 8 units and, for each winding, is completely equivalent to the existence of X bosons, quarks and particles with positive and negative charge of a unit of e.

Indeed: The X bosons have an electric charge of $4/3$, $1/3$

Quarks and squarks: $2/3$, $-1/3$

Finally, particles with unit charge $+1$, -1

The sum, counting the colors of the quarks, s-quarks and bosons X: $|3(4/3 + 1/3)| + |3(2/3 - 1/3)| + |-1| + |+1| = 8$

The fraction : $(|3(4/3 + 1/3)| + |3(2/3 - 1/3)| + |-1| + |+1|)/3$, as discussed below, has a direct relationship with the determination of the X boson mass, or GUT scale unification.

$(|3(4/3 + 1/3)| + |3(2/3 - 1/3)| + |-1| + |+1|)/3 = 1/\sin^2 \theta_w(GUT)$

These results suggest that the superparticle have an electric charge the same central mark is located on the surface of the torus, causing a repulsion that would wind states of dimension 3. Within the surface of negative curvature of the torus there would be a distribution of electric charge self-repulsive force offsetting the outside, allowing a minimum of stability of the torus. Likewise, it could present properties of a magnetic monopole.

$(8/3) = \dim[SU(3)]/(\dim[SU(2)] \times \dim[U(1)])$

$(8/3)4\pi - [(10\pi/28)(\alpha_{em1}^{-1}(m_Z) - \alpha_{em2}^{-1}(m_Z))] = A$; $[(10\pi/28)(\alpha_{em1}^{-1}(m_Z) - \alpha_{em2}^{-1}(m_Z))] = \ln(m_X/m_Z)$

Sum of the divisors of 24:

$\dim[SU(5)] = \dim[SU(3)] \times \dim[SU(2)] \times \dim[U(1)] = 24$ $\sigma(24) = 60$; $\sigma(24) - 24 = 3colors \times 6quarks + 1e_- + 1\mu_- + 1\tau_- + 3\nu + 2w_{+-} + 1Z + 1\gamma + 8gluons$

Sum of the squares dividers 24, except 24: $\sum_{d/24 \ d < 24} d^2 = 2[\alpha^{-1}] = 2 \cdot 137$

Number divisors of 24: $\tau(24) = 8$

$$\sqrt{\hbar}/e_{+-} = 8^2 + 1/(10 \sin 2\theta_{13})^2 - 1/(24[240 + (\sum_{d/24} d^2 - 24^2)/\{2 - (1/10A)\}]) \quad , \quad \dim[SU(5)] = 24$$

$$240 + (\sum_{d/24, d < 24} d^2)/2 = 377$$

$$1/(24[240 + 137 - (1/10A)]) \cong 1/24[(\sum_{n=1}^{12} F_n) + l_p^{-1}(7D) + R_H^{-1}(7D)] \quad F_n = \text{Fibonacci number series}$$

The value, almost equal, the formula to 64, is also explained by the interaction matrix of the 8 values obtained above in absolute value. Form a matrix of interaction that can be interpreted in two ways: a) 8 x 8 matrix of particle-antiparticle interaction. b) An array of self-interaction of single particles or antiparticles. The first case would indicate that the existence of particles electrically charged would be limited to 32 as upper limit. In the second case, there would be an upper limit of 64 particles with electric charge.

$$\text{Torus genus 2: } n_c(g = 2) = (7 + \sqrt{1 + 48 \cdot 2})/2$$

$$\sqrt{\hbar}/e_{+-} + (n_c(g = 2) - 4 \text{ colors}) - (\sqrt{\hbar}/e_{+-})^{-3/2} \cong \alpha^{-1}/2$$

Advancing a result of a later section:

$$(R_H^4(7D)\pi^2/2 - \sqrt{\hbar}/\pi e_{+-}) + \sin^2 2\theta_{13} = 4\pi^2 R_H(7D)l_p(7D)$$

5.1 Kissing number in 24 dimensions, the GUT unification scale and the Higgs boson

The standard model to the energy scale of electroweak unification, regardless of the boson Higgs, consists of twenty-four particles. This number shows a symmetry about the number of fermions and bosons, 12 fermions and 12 bosons. Twelve is the kissing number in three dimensions. 12 is also the sum of: $\dim(SU(3)) + \dim(SU(2)) + \dim(U(1))$. Twenty-four is the kissing number in four dimensions. Finally, to 24 dimensions, the kissing number is 196560

The eight dividers of 24, are: 1, 2, 3, 4, 6, 8, 12, 24

These dividers can be made the following table of equivalence:

Bosons:

$$1 \quad 1\gamma \rightarrow U(1) \quad 3 \quad w_+ \quad w_- \quad Z \rightarrow SU(2) \quad 4 \quad w_+ \quad w_- \quad Z \quad \gamma \rightarrow SU(2) \times U(1) \quad 8 \text{ gluons} \rightarrow SU(3)$$

Fermions:

$$6 \rightarrow 6 \text{ quarks} \rightarrow 3_-(e, \mu, \tau) + 3\nu$$

Fermions + Bosons:

$$12 \quad (6 \text{ quarks} + 3_-(e, \mu, \tau) + 3\nu) + 8 \text{ gluons} + w_+ + w_- + Z + \gamma = 12 + 12$$

Bosons X:

$$24 \rightarrow SU(5) \rightarrow SU(3) \times SU(2) \times U(1)$$

Lack an equivalent to the number 2. And, it seems that the only possible candidate is the boson Higgs:

$$2 \rightarrow H \quad H_+$$

1. $\sin_{eff}^2 \theta_w(m_Z) = 0.23146 \quad (4\pi/3) + \pi \ln^2(\pi^2/2) - (3^2 + 2^2 + 2 \sin_{eff}^2 \theta_w(m_Z))^{-2} = \ln K(24D) = \ln 196560$
2. $\ln K(24D) \cong (4\pi/3) + 8$
3. $K(24D) \sqrt[4]{(24/8\pi)} \cong (m_Z + m_w + m_H)/3m_e$
4. $\ln(m_H/m_e) + 1 \cong \ln[2(m_Z + m_w/m_e)]$
5. $K(24D)\sqrt{\ln 21} \cong \sqrt{(m_Z/m_e)^2 + (m_w/m_e)^2 + (m_H/m_e)^2}$
6. $\ln(m_X/m_e) = (8/3)4\pi - \frac{24(8^2 + 1/(10 \sin 2\theta_{13})^2 - \sqrt{\hbar}/e_{+-})}{240 \left(240 + \left(\sum_{d/24} d^2 - 24^2 \right) / 2 \right) \left(8^2 + 1/(10 \sin 2\theta_{13})^2 - \sqrt{\hbar}/e_{+-} \right) - 10}$
7. $\ln(m_X/m_e) = [4\pi/\sin^2 \theta_w(GUT)] - \frac{24(8^2 + 1/(10 \sin 2\theta_{13})^2 - \sqrt{\hbar}/e_{+-})}{240 \left(240 + \left(\sum_{d/24} d^2 - 24^2 \right) / 2 \right) \left(8^2 + 1/(10 \sin 2\theta_{13})^2 - \sqrt{\hbar}/e_{+-} \right) - 10}$
8. $\Omega_b = \cos \theta_1 / [(l_p(7D) + R_H(7D) \cos \theta_1) R_H(7D)] \quad \theta_1 = 46.230^\circ$
9. $[4\pi^2 - (1 + \sin \theta_1/2)]^2 + K(24D) = \sqrt{(m_Z/m_e)^2 + (m_w/m_e)^2 + (m_H/m_e)^2}/3$

6 Cosmological consequences of theory

6.1 The Hubble constant: frequency of the cosmological vacuum energy

Since the cosmological vacuum has a negative energy of about $\cong -2.39 \times 10^{-3} eV$; according to formula (23) and the equivalence with the cosmological equation of general relativity, such that:

$$\rho - 3p = -2\rho$$

To maintain consistency with quantum theory must meet:

$$\hbar\omega_{(-2\rho)} = E_{(-2\rho)}$$

Since it is fulfilled according:

$$40^2 - [\ln(m_H/m_e) = 39.110535526566]^2 = 70.36601082522 = \ln(m_P/m_v); \text{ then it must meet:}$$

$$E_{(-2\rho)} = m_P c^2 \exp -(2[40^2 - \ln^2(m_H/m_e)])$$

If calculated this frequency -2ρ , we have:

$$E_{(-2\rho)}/\hbar = \omega_{(-2\rho)} = (m_P c^2 \exp(-2[40^2 - \ln^2(m_H/m_e)]))/1.0545716287769 \times 10^{-34} J \cdot s = \dots$$

$$\dots = 1.4867807860044 \times 10^{-52} J/1.0545716287769 \times 10^{-34} J \cdot s = 1.4098433386916 \times 10^{-18} Hz$$

This is the frequency of repulsive energy -2ρ

The inverse of this frequency is a time equal to:

$$(1.4098433386916 \times 10^{-18} Hz)^{-1} = 7.0929866642349 \times 10^{17}$$

And what actually is this time is the inverse of the constant Hubble with a correction factor:

$$7.0929866642349 \times 10^{17} / \exp([(l_\gamma - R_H(7D))^{-1/2} - 1]^2) = 4.336 \times 10^{17} s$$

$$([l - R_H(7D)]^{-1/2} - 1)^2 \approx 2[40^2 - \ln^2(m_H/m_e)] - 140 - \sin(2\pi/26)$$

$$H_0 = \omega_{(-2\rho)} = (m_P c^2 \exp(-(140 + \sin(2\pi/26)))/\hbar = 1/4.336 \times 10^{17} s$$

In a later section show that exactly met:

$$H_0 = (r(\alpha^{-1})l_p/c) \exp\left(\sinh(\pi^2/2) + \cosh(\pi^2/2)\right) = 4.3376434552555 \times 10^{17} s$$

$$H_0 = \left[\left(\sqrt{\hbar G_N/c^3} \sqrt{\alpha^{-1}/4\pi}\right)/c\right] \exp\left(\exp(\pi^2/2)\right) = 4.3376434552555 \times 10^{17} s$$

That is: The Hubble constant is the frequency repulsive vacuum energy.

And since the age of the universe is a function of the Hubble constant, leads to the unequivocal conclusion that the universe appears to have a number of years that does not correspond to reality, by the incorrect interpretation of what really is the Hubble constant. It follows, that the age of the universe is not so far is maintained.

What is the actual age of the universe?. We do not know, but certainly not 13.75 billion years.

6.2 Creating energy by emptying the space-time to expand

Previous sections showed the equivalence: $\rho - 3p \iff 70 - 3 \times 70 = -2 \times 70 = -140$

That is, the part of the repulsive negative pressure corresponds to -3×70

What has been shown in paragraph 3.1.2 and the formulas (8), (9) and (11); one has that this negative pressure, can be translated in function of their mass equivalent or equivalent length, as:

1. $\Delta x \Delta p \geq \frac{\hbar}{2}$ (8)

2. $2\left(\frac{\Delta x_1}{\Delta x_2}\right) = 2\left(\frac{\Delta p_2}{\Delta p_1}\right) = 2\left(\frac{\Delta m_2}{\Delta m_1}\right)$ (9)

$$3. \ 2 \left| \ln \left(\frac{l_1}{l_0} \right) \right| = 2 \ln \left(\frac{m_P}{m_1} \right) \quad (11)$$

$$-3p \rightarrow [3 \ln(m_P/m_v)] = [3 \ln(l_v/l_P)] \quad (46)$$

Now we calculate the density with the values deduced by the formula $70.36601082522 = \ln(m_P/m_v)$

$$\rho = m_v / \frac{4\pi}{3} l_v^3 = m_P \exp - (70.36601082522) / \frac{4\pi}{3} [l_P^3 \exp(3 \times 70.36601082522)] = 7.10965 \times 10^{-27} \text{ Kg/m}^3$$

$$\text{Fulfilled, logically, that: } \rho = m_v / \frac{4\pi}{3} l_v^3 = (3H_0^2 / 8\pi G_N) \Omega_v \quad (45)$$

With the current data must be $(3H_0^2 / 8\pi G_N) \cong 9.511 \times 10^{-27} \text{ Kg/m}^3$

Finally, with the value deduced with this theory for $\Omega_v = 0.725044\dots$

$$0.725044 \times 9.511 \times 10^{-27} \text{ Kg/m}^3 = 6.8958 \times 10^{-27} \text{ Kg/m}^3 \approx 7.10965 \times 10^{-27} \text{ Kg/m}^3$$

Thus, by (8), (9), (11) and (36) matter must be created to meet the equality (11) by changing the scale. Scale change, which occurs also when increasing by expansion space. We have seen that the distinction between space, time and matter-energy is purely caused by different configurations that takes the underlying geometry of space.

These different configurations are the observer categorized as mass, energy, space and time. But the border, at the quantum level, the level of the last length scale quantified, does not exist.

The mass would be the dimensions compacted following the change of scale given by (11)

Therefore the density of the universe remains constant with time.

The nature of the decay of empty space-time expansive changing its configuration to result in a remnant of mass-energy, there remains a more precise knowledge of these geometric-topological changes, of which this theory makes a humble research.

This "creation" of matter must happen at the very edge of the expansion front, with speeds greater than light, where special relativity does not apply. Rather it was feasible to consider as a simile, that this "creation" of tunnel effect is a matter that does not meet the special relativity. But not really be a tunnel effect.

Exactly is the space to expand, set up or expanded in a space, perhaps infinite dimensional, which "creates" matter by increased length, and therefore if length increases, occurs a change of scale; which implies which must meet (11)

Spacetime, matter-energy, basically the same.

But logical assumptions, we think that this decay or creation, transformation, change configuration space expansion, should take the lowest possible energy, which points to a decay of photons, neutrinos and electrons.

$$\text{Observe as: } 9.511 \times 10^{-27} \text{ Kg/m}^3 / 6 \approx 3 \times 2(m_e + m_{proton}) / m^3$$

$$3 \times 2(m_e + m_{proton}) / m^3 > 9.511 \times 10^{-27} \text{ Kg/m}^3 / 6$$

These relationships suggest the creation of 3 pairs of hydrogen atoms if there were matter antimatter symmetry, possibly indicating a decay mediated by photons, perhaps, of the 3 known neutrinos.

7 Connecting the monster group, the superparticle, the Fibonacci numbers and the Higgs vacuum

In this section we show how there is a clear connection between the group M , the toric surface dependent $l_P(7D)$, $R_H(7D)$, Fibonacci numbers and finally the value obtained for the mass of the lightest boson Higgs in relation to the mass of the electron.

As was shown in section 3, the mass of the electron is a special reference scale in nature. We show that this finding (mass of electron) is consistent with the treatment of mass, not zero, as states topological compactified dimensions and densities of hyperspheres mutually related in dimension 8 (symmetric vacuum by 240).

The state of vacuum, particle-antiparticle pairs, has been shown that this constituted by the maximum amount of spheres that are touched mutually already a central, in a space of 8 dimensions. The breakdown of this vacuum by way of electromagnetism, divided this into two parts: a non-zero mass compacted states, and a zero mass at rest or not compacted mass. The share of non-zero mass corresponds to electron-positron pairs, compactness or density compared to the Planck mass, governed by equation (11)

Shown, equally, that the sum of both terms (14), gives rise to an asymmetry respect to 240, which is the kissing number of 8D, which corresponds to the baryonic density of the universe; in turn dependent of the curvature inner ring of the superparticle.

A curl by layers of toric surfaces by the 8 octonions, leaves 7 dimensions compacted by circular layers $(2\pi)^7$; more one for the dimension of time or oscillation of the dimensions of space. Therefore, it is conceivable that an initial natural angle of curvature inside-outside (both equal but opposite in sign) corresponds to the 3D torus $2\pi/8$

The density of compactification of hyperspheres in 8D is: $\pi^4/384$; and the inverse of this value is then a differential minimum of particles per change of scale, and that therefore must be governed by equation (11). Thus we have: $\pi^4/384 = \rho[K(8D)]$, $\rho^{-1}[K(8D)]$

$$2d(\rho^{-1}[K(8D)])/\rho^{-1}[K(8D)] = 2d(\ln(m_P/m_e))$$

The share of the matter antimatter asymmetry with an angle of $2\pi/8$, is expressed by: $2K(2\pi/8, l_P(7D); R_H(7D)) = 2 \cos(2\pi/8)/[(l_P(7D) + R_H(7D) \cos(2\pi/8))R_H(7D)]$

Therefore, can be expressed the compacted part of the vacuum as:

$$(240 + 2K(2\pi/8, l_P(7D); R_H(7D)) - \alpha^{-1}) = 2d(\rho^{-1}[K(8D)])/\rho^{-1}[K(8D)] = 2d(\ln(m_P/me))$$

$$(240 + 2K(2\pi/8, l_P(7D); R_H(7D)) - \alpha^{-1}) = 2 \int d(\rho^{-1}[K(8D)])/\rho^{-1}[K(8D)] = 2 \int d(\ln(m_P/me))$$

$$(240 + 2K(2\pi/8, l_P(7D); R_H(7D)) - \alpha^{-1}) = 2 \exp(384/\pi^4) = 2 \ln(m_P/me) + C$$

Finally, the calculation is consistent with experimental data:

$$2 \cos(2\pi/8)/[(l_p(7D) + R_H(7D) \cos(2\pi/8))R_H(7D)] = 0.092889547262927$$

$$(240 + 0.092889547262927 - 137.035999084) = 2 \exp(384/\pi^4) = 2 \ln(m_P/me) + C$$

And the constant C, dependent on the accuracy of the fine structure constant, the mass of the electron, Planck's constant, that of gravitation, gives a value of:

$$(240 + 0.092889547262927 - 137.035999084) - 2 \ln(m_P/me) = C$$

$$\text{This constant appears to be exactly: } 2\pi\alpha^{-1} - (C)^{-1} = 10/\{(8/3)4\pi - [(10\pi/28)(\alpha_{em1}^{-1}(m_Z) - \alpha_{em2}^{-1}(m_Z))]\}$$

As developed in Section 3, we have the equation (4):

$$n_r(e^-) = \alpha^{-1} - \frac{\alpha^{-1}}{4} \quad (4)$$

This equation is improvable to approximate (11), for the electron mass in relation to the Planck mass, by:

$$n_r(e^-) = \alpha^{-1} - \frac{\alpha^{-1}}{4} + \tan^{-4}(3\pi/10) \cong 2 \ln(m_P/m_e)$$

The inverse of the fine structure constant α^{-1} ; seems to be a function dependent $\rho^{-1}[K(8D)]$:

$$\exp(\rho^{-1}[K(8D)] + (10 \sin(2\pi/60))^{-1/2}) + (\rho^{-1}[K(8D)]240 + \sqrt{5 + \sqrt{\ln \dim[SU(4)] - 1}})^{-1} = \alpha^{-1}$$

$$(\pi^2/2 - 1)^4 + (40^2 - \ln^2(m_p/m_H) - 70 + 1)^{-4} \cong 240$$

$$\rho^{-4}[K(8D)] - \exp(384\rho[K(8D)] - 97) - \exp\left(\sqrt{240 \cos^2 2\theta_{13}}\right) = 240$$

Recalling that $(2\pi/60)$, corresponds to an angle of 60 particles, with corresponding 60 supersymmetric particles.

7.0.1 The group M, the Fibonacci series and the symmetry of the vacuum

The order of the group M is: $2^{46} \cdot 3^{20} \cdot 5^9 \cdot 7^6 \cdot 11^2 \cdot 13^3 \cdot 17 \cdot 19 \cdot 23 \cdot 29 \cdot 31 \cdot 41 \cdot 47 \cdot 59 \cdot 71$

By simple observation. is found that is the product of fifteen prime numbers, 6 of them elevated to the Powers 46, 20, 9, 6, 2 and 3

These powers follow a pattern generated with the 3-dimensional space, turn the first 3 numbers of the Fibonacci series (except for the 1 repeated): 1, 2 and 3

$$2, 3, 3 \cdot 2 \cdot 1 = 3! = \dim[SO(4)], 3^2, 20 = 9 + 6 + 2 + 3 = \sum_{n=1}^6 F_n$$

$$(20 + 9 + 6 + 3 + 2) + 6 \text{ powers} = 46$$

$$4! = 24 = 9 + 8 + 7 \quad , \quad (9 + 8 + 7)10 - 9^2 - 8^2 - 7^2 = 46 = 240 - 9^2 - 8^2 - 7^2$$

$$\dim[SO(9)] + \dim[SO(8)] + \dim[SO(7)] + \dim[SO(2)] = 46 + 20 + 9 + 6 + 3 + 2 = 240 - 153 - 1$$

Two other outstanding properties, which are thought not by chance:

$$1. \quad \sum_{p/Or(M)} (\ln p/p^2) = 0.4718727042 = \sin \theta_w \quad ; \quad \cos \theta_w = m_w/m_Z$$

2. 10D sphere coordinates generated in the first 10 prime numbers dividing the order of the group M, their arithmetic mean:

$$(2^2 + 3^2 + 5^2 + 7^2 + 11^2 + 13^2 + 17^2 + 19^2 + 23^2 + 29^2)/10 = 239.729 \approx l_p^2(7D) + R_H^2(7D) + r^2(\alpha^{-1}) \quad \left(\sum_{p \leq 29/Or(M)} (\ln p/p^2) \right) / 2 =$$

$$\sin^2 \widehat{\theta}_w(M_Z)(\overline{MS}) = 0.2311651517$$

Arithmetic mean squares sum up to 26 dimensions:

$$(\sum_{d=1}^{26} d^2)/26 + 3/2 = 240$$

These first 6 primes have the property that the sum of its cartesian coordinates, corresponding to a sphere of 6 dimensions, has these four very remarkable properties:

$$1. \quad \text{The sum of 6 spherical coordinates given by these first 6 prime numbers: } 2^2 + 3^2 + 5^2 + 7^2 + 11^2 + 13^2 = 377 = 240 + \lfloor \alpha^{-1} \rfloor$$

$$2. \quad \text{The sum of all primes dividing the order of the group M: } (2 + 3 + 5 + 7 + 11 + 13 + 17 + 19 + 23 + 29 + 31 + 41 + 47 + 59 + 71) = 2^2 + 3^2 + 5^2 + 7^2 + 11^2 + 13^2 + 1$$

3. 377 is the 13 number of the Fibonacci series. Item 2 provides an sphere of 7 dimensions.

$$4. \quad (2 + 3 + 5 + 7 + 11 + 13) = 41 \quad \sqrt{41^2 - 153 + [(\alpha^{-1} - 137)^{-1} - 163/6]^{-1}} \approx \ln(m_p/m_H)$$

Number 153 Table IX

The sum of the rest of prime numbers of the order of M group has this remarkable property:

$$\left\lfloor \left[\sqrt{(17 + 19 + 23 + 29 + 31 + 41 + 47 + 59 + 71)} + 7 \right] / 2 \right\rfloor = \text{colors number torus } g = 7$$

$$\left\lfloor \left[\sqrt{(17 + 19 + 23 + 29 + 31 + 41 + 47 + 59 + 71)} + 7 \right] / 2 \right\rfloor = \left\lfloor n_c(g = 7) = (7 + \sqrt{48 \cdot 7 + 1}) / 2 \right\rfloor$$

The sum of the cartesian coordinates of a sphere 15 dimensional, the primes dividing the group M:

$$(2^2 + 3^2 + 5^2 + 7^2 + 11^2 + 13^2 + 17^2 + 19^2 + 23^2 + 29^2 + 31^2 + 41^2 + 47^2 + 59^2 + 71^2) = 15770$$

The sum of cartesian coordinates of a sphere 8 dimensional obtained by:

$$\sum_{p/Or(M)} p^2 - \sum_{p \leq 13/Or(M)} p^2 = \sum_{p > 13/Or(M)} p^2 = 15393$$

This sphere of 8 dimensions has this remarkable property:

$$(\sum_{p>13/O_r(M)} p^2)4^2 + 2(\sum_{p\leq 13/O_r(M)} p^2) - 2 = 247040 = (\dim \text{real}(E8))^2 + 32^2 = m_H/m_e$$

The above expression can be changed by:

$$247040 = (\dim \text{real}(E8))^2 + 32^2 = (\sum_{p/O_r(M)} p^2)4^2 - 71^2 (= 7! + 1) - 240 + 1$$

Number 153 Table IX

$$\text{Another remarkable property: } \sum_{p/O_r(M)} p^2 = 153 \cdot 2 \ln(m_p/m_e) + (\ln 240 - 3)$$

7.0.2 The group M and four-dimensional volume of the center of the torus of the superparticle

If the 7 dimensions correspond to 7 torus compacted layers of dimension 3, mixed state, or put another way: if the last layer of the compactification is a 3D torus, then the 4 dimensions should not compacted spherical volume correspond to the center of the torus.

And this volume is: $R_H^4(7D)(\pi^2/2) = 377.2637873439$

$$[\{(\sum_{p/O_r(M)} 1/p^2) + \dim[SO(10)]\}/(\sum_{p/O_r(M)} p) - 1] + \sum_{p\leq 13/O_r(M)} p^2 \cong R_H^4(7D)(\pi^2/2)$$

$$240 - \dim[SU(10)] = \lfloor 2 \ln(m_p/m_v) \rfloor$$

And for the surface of a torus dependent of $2\pi/60$; we have:

$$\sin^{-1}(2\pi/60)4\pi^2 - (\ln 247040 - 12) = R_H^4(7D)(\pi^2/2)$$

Considering four spherical surfaces with radius $l_p(7D)$, $R_H(7D)$, $r(\alpha^{-1})$, 1 ; we have:

$$(l_p^2(7D) + R^2(7D) + r^2(\alpha^{-1}) + 1^2)4\pi = 376.9821247817$$

$$(l_p^2(7D) + R^2(7D) + r^2(\alpha^{-1}) + 1^2)4\pi + \cos^2 \theta_w = 377$$

All these results demonstrate the indistinguishability between surface-ring, four-dimensional volume, spherical surfaces. A multistate topological while an unambiguous connection with the group M, whose scope deep know.

In the next section will show the importance of these results to establish the primeval inflation factor expansion of the universe.

A final result of this section:

If one considers $\pi^2/2$; as the fourth power of a radius given by $\pi \sin(2\pi/8)$; we have the following four-dimensional volume of a sphere 4D:

$$(\pi \sin(2\pi/8))^4(\pi^2/2) = 120 + \sin(2\pi/6^2)$$

7.1 The inflation: a natural consequence of the theory

In this last part will show up as inflation is a mandatory consequence of the theory. Some of the results presented have not been rigorously deduced from a complete mathematical formulation; but by its internal logic and consistency, accuracy and connections that are established, we think that should be considered as deriving from a unified theory that will undoubtedly be established, based on some string theory must take into account the number theory, topology, groups, etc..

In fact, we think that this theory itself contains all the math. Although it sounds very daring, we postulate this conjecture.

In section 5 were obtained as electrical charges quantized topological states dependent curvatures of the torus, so the same as are the spines.

These results were obtained as fundamental consequence of the division of a circle or curl at an angle of $\pi/2$. A natural arc length is considered as a function of radius π ; in this way one has, by one hand, a quantified arc $\pi^2/2$; which can also be treated as a dual status: radio-angle. Therefore, if added this duality, it would have:

An arc length quantum, minimum, of rolling up $\pi^2/2$; which corresponds to a minimum radius of $(\pi^2/2)/2\pi = 2\pi/8 = \pi/4$ (Octonions and quaternions). And an angle $\pi^2/2$

And here, it appears naturally as a 4 dimensional volume of a unit radius about the Planck length equal and isomorphic to: $(\pi^2/2)1^4 = \pi^2/2$

It has been shown in previous sections that for an 8D torus with circular windings is necessary the introduction of the octonions, which allow for the square of its values, get the 8 curls, and 7 negative curvature. Curvatures that must contemplate as views from within the inner part of the surface of torus.

The need for a dynamic, changing, oscillation, etc., requires the purchase time coordinate values that run these octonions, producing curvatures, curls. That is, for the surfaces of the torus: $(cte_1)(ct'e_1)$; $cte_1 = x_1$, $ct'e_1 = x'_1$;, $(cte_7)(ct'e_7)$

The states of curls obtained by introducing the speed of light and time, can be covered qualitatively and equivalents at speeds quadratic negative, so that: $-c^2tt' = -xy$

The minimum arc quantified, for the fulfillment of relativity, should be expressible through these negative quadratic speed as: $l' = \pi^2/2$; $l_0 = 1 = l_p/l_p$

$$l' = l_0 \sqrt{1 - (-\pi^4/4 + 1)} = l_0 \sqrt{1 - (-\frac{\pi^4+4}{4})}$$

By simple algebra will automatically prove the veracity of this result, when unifies electromagnetism and gravity through a natural mass that generates an electrical charge, as follows:

$$\pm \sqrt{(m_P^2 (\frac{4}{-\pi^4+4})^2 G_N)/c} = \pm e' ; \pm e' = 4\sqrt{\hbar}/(\pi^4 - 4)$$

And with very good approximation is fulfilled, verifying the duality angle arc length $\pi^2/2$:

$$\pm e' / \pm e = \left([r(\alpha^{-1}) - R_H(7D)] / [1 + R_H(7D) - r(\alpha^{-1})] + 3 \right)^2 \cos(\pi^2/2)$$

The inescapable conclusion is that the superparticle there a speed greater than c , a result that does not contradict relativity.

We have, for a minimum unit of measurement coordinate, say x , is satisfied: $-c^2 tt'/y = -x$; $-x = -1 = -l_p/l_p$

By the hyperbolic functions and following the modified special relativity by rolling through the octonions, we have:

$$-x' = -x \cosh(\pi^2/2) + citi \sinh(\pi^2/2) = -x \cosh(\pi^2/2) - ct \sinh(\pi^2/2) = \exp -(\pi^2/2)$$

By applying equation (11), by changing the scale, it must meet: $\exp -(\pi^2/2) = \ln(l_{X'}/l_P)$

Finally, we have an inflationary expansion factor limit: $\exp(\exp(\pi^2/2))$

This value is fully consistent with the limit of the fine structure constant of electromagnetism, which implies the decoupling of radiation and on the other hand, is a value next to $2 \ln(m_P/m_v)$. It has both of the end of inflation: decoupling radiation and obtaining the value of the vacuum energy by emptying the spacetime creation-energy inflationary expansion to occur, caused by the instability of the superparticle, in what we conjecture is a real dimensional infinite space. It will show how this infinite dimensional space is more than pure theory, but still: we argue that there can not be multiverses for the reason that the infinite summation in the sums of the volumes of hyperspheres of radius unity, the infinite dimensional space is less than the sum of the cartesian coordinates for a given spherical dimensional space 11 defined in paragraph 4.2: $l_P^2(7D) + R_H^2(7D) + l^2\gamma + l_P^2(x) + l_P(y) + l_P^2(z) + l_P^2(ct) + 2^2 + 2^2 + 2^2 + 2^2 = 48.999284308147$

Moreover, the same summation but extended to the surfaces of these hyperspheres is a value below the area of the torus defined by $4\pi^2 l_p(7D) R_H(7D) = 356.966116156334$

The sum in the limit to infinity of all surfaces and volumes of spheres d dimensional conducted with the 8.04 mathematica program , to a value of $d = 10000$, gives this result:

$$\sum_{d=1}^{10000} \pi^{d/2} / \Gamma(d/2 + 1) = 44.9993260893828.... = \sum_{d=1}^{10000} V(d) < l_P^2(7D) + R_H^2(7D) + l^2\gamma + l_P^2(x) + l_P(y) + l_P^2(z) + l_P^2(ct) + 2^2 + 2^2 + 2^2 + 2^2$$

$$\sum_{d=1}^{10000} 2\pi^{d/2} / \Gamma(d/2) = 291.022289824972... = \sum_{d=1}^{10000} S(d) < 4\pi^2 l_p(7D) R_H(7D)$$

With the length of the torus given by $l_\gamma l_p = r(\alpha^{-1}) l_p$; you get exactly the Hubble constant to limit inflation factor deduced:

$$H_0 = \left[\left(\sqrt{\hbar G_N / c^3} \sqrt{\alpha^{-1} / 4\pi} \right) / c \right] \exp \left(\exp(\pi^2/2) \right) = 4.3376434552555 \times 10^{17} s$$

Therefore, the present volume of our universe grew up in a time of $[\exp(\pi^2/2) + \ln(l_\gamma)] t_p = 140.24024636634 \cdot t_p$

Clearly, the mass of the universe responds to the same limit inflation. Taking the minimum mass planck, of a black hole in seven dimensions, it has a mass for the universe exactly at the end of inflation, in:

$$M_U = m_p(7D) \exp(\exp[(\pi^2/2)]) ; m_p(7D) = \hbar/c R_H(7D)$$

$$\rho^t = m_p(7D) \exp(\exp[(\pi^2/2)]) / [(4\pi/3) \{R_H(7D) l_p \exp(\exp(\pi^2/2))\}^3]$$

$$\rho^t / \rho_c \cong (\sin(2\pi/26) + \Omega_b)$$

This result seems impossible for the possible arguments that there was no time for evolution to create galaxies, etc, etc, has only one answer, in our humble opinion, God, Father ommipotent was not idly by and do not know details of their creative work. What the limited and finite intelligence of man seems impossible, is not so for an infinite intelligence and boundless as that of God.

The mathematical results are what they are, and they speak for themselves.

The two sums of all hyperspheres volumes and surfaces seem to be related to the dimensionality necessary for the existence of our universe and is an additional mathematical argument seems to leave no doubt of the interconnection dependent infinite dimensional space, which can only generate a space-time only solution: our universe.

1. $\sum_{d=1}^{\infty} \pi^{d/2}/\Gamma(d/2 + 1) + \sum_{d=1}^{\infty} 2\pi^{d/2}/\Gamma(d/2) \approx 336.021615914355$; 336, is precisely the Kissing number of $K(10D)$
2. $\sqrt{\sum_{d=1}^8 (K(d))^2} + \sqrt{[\ln(m_p/m_H)] + \tan(2\pi/6)} = 291.022290288253 \approx \sum_{d=1}^{\infty} 2\pi^{d/2}/\Gamma(d/2)$
3. For a 3D volume of a sphere with unit radius:

$$\sinh(4\pi/3) + \cosh(4\pi/3) + \sum_{d=1}^{\infty} 2\pi^{d/2}/\Gamma(d/2) \approx 4\pi^2 l_p(7D) R_H(7D)$$

- $\ln \alpha^{-1} = 4\pi/3 - \ln \ln \varphi + (1/\sum_{p \leq 137} p^2) \varphi = \text{Golden ratio} ; p = \text{prime number}$
- $\sum_{p \leq 137} p^2 = (m_Z/m_e) - (m_e + m_\mu + m_\tau)/m_e - \pi/4$
- $\ln \alpha^{-1} \approx \pi^2/2 - 2/(136 + \tan(3\pi/10))$
- $\sum_{d=1}^{\infty} 2\pi^{d/2}/\Gamma(d/2) \approx (97 \cdot 3 + 1/\sum_{d=1}^{\infty} \pi^{d/2}/\Gamma(d/2 + 1)) \approx 97 \cdot 3 + (1/10 \sin(2\pi/24))^4$
- $97^2 - 4\pi^2 l_p(7D) R_H(7D) + 10(1 - \Omega_v - \Omega_b) \approx 24(R_H^4(7D)\pi^2/2)$

8 The oscillatory phenomenon of radius π , the compactification of spheres in three dimensions and the vacuum Higgs

In this section we show that the minimum energy state of the Higgs vacuum, represented by the mass of the lightest Higgs boson, corresponding to a direct function of the oscillation of the radius π ; which generates the three radii $l_p(7D)$, $R_H(7D)$, l_γ , and its direct relation to the maximum possible compactification of spheres in three dimensions and his density factor.

Wrapped in the d-dimensional hyperspheres allows us to give a possible solution to certain minimum energy states, such as the vacuum, by the properties of packing in the smallest space possible the maximum amount of "wavelengths." Moreover, this type of Wrapped has another interesting property: all hyperspheres touch each other and a central location. This property may be related to topological quantum entanglement. If this is so, then there must be a topological invariant related to the total mutual connectivity of these hyperspheres that accounts for the "instantaneous transmission of information." We can go further and

propose a scale invariance, a topological invariant distribution hyperspheres defined by a fractal, a fractal dimension. They show that this possibility is quite likely.

1. Other sections have shown how the packing of hyperspheres in 8 dimensions, determines the ratio of the Planck mass and the mass of the electron, which in turn by its sum with the inverse of the fine structure constant, allowed us to calculation of the matter antimatter asymmetry and the value of the mass density of baryons in the universe.
2. Without knowing the exact mathematical nature of the geometry involved, if it has been possible to identify several crucial aspects of it. a) The information in holography surfaces of spheres with cartesian coordinates, as sums of squares. b) The sum of the squares of the top three Planck length. c) The seven-dimensional compactification. d) the equivalence of the formula (11) with such sums as representing different quadratic partitions breaking the vacuum. e) The determination of the quantification of the possible values of the electric charge by introducing the minimum arc angle $\pi^2/2$. f) The direct and natural deduction of inflation and its limit value by the introduction of this arc-angle.
3. The finding that the combination of ten dimensions taken by $\binom{10}{7}$, or its equivalent $\binom{10}{3}$; gives exactly the amount of vacuum particles, 120. The inability to be a mere chance, just the product of the maximum number of spheres which touch each other, and a central, three-dimensional, by the ten dimensions, allows us to obtain, again these 120 particles. $K(3D) \cdot 10 \text{ dimensions} = 120 = \dim[SU(11)] = (5 \text{ spins})!$
4. The combinations of eight dimensions taken by $\binom{8}{4}$ (Octonions and quaternions); gives the sum of the spherical cartesian coordinates with the integers from one to 24, $70^2 = \lfloor \ln^2(m_p/m_v) \rfloor$
5. The packaging of the 24 spheres in four dimensions mutually related, yields 240 as the product: $24 \cdot 6D \cdot 6$ being the dimension of area of the sphere in seven dimensions and $6 = K(2D)$; $K(4D) = K(3D)K(1D) = K(2D)4D$
6. Obtaining 240, as the sum of : $K(2D) + K(3D) + K(4D) + K(6D) + K(7D) = 240$; and : $K(5D)K(2D) = 240 = 2K(3D)10D$
7. All these results lead us fairly safe to say that the mass of the lightest Higgs boson should be able to be expressed as the minimum energy state of the vacuum as a direct function of the angle of oscillation, the maximum amount of compacted spheres in three dimensions, 12, and his density in these three-dimensional compactification.
8. The mass of the electron as a reference mass by its nature less massive particle with electric charge, and as the electric charge is a topological effect of the compactifications.
9. The key role of the Fibonacci spiral and the associated numbers, even without knowing the full extent of the role of this series of numbers with very peculiar properties.
10. The numerical results are too accurate to ignore them, taking into account the highly unlikely chance of the same.

The equations confirm, without a doubt, we think, the oscillatory nature of the three radius as a function of π . Also, as indeed the mass ratio, mass Higgs boson and electron mass, complying with the formula (11), is an oscillatory function of this phenomenon and of the 12 spheres $K(3D)$, and his density of compactness $\rho(K(3D)) = \pi/\sqrt{18}$

If this approach is correct, you should be able to obtain the Higgs boson mass in relation to the Planck mass by an equation as simple as the following, taking into account the angle given by the 8 dimensions $2\pi/8 = 4/\pi$:

From equation (8), (9), (11); and the space-time quantification by cartesian coordinate spheres, we have:

$$\Delta x \Delta p \geq \frac{\hbar}{2} \quad (8) \quad 2\left(\frac{\Delta x_1}{\Delta x_2}\right) = 2\left(\frac{\Delta p_2}{\Delta p_1}\right) = 2\left(\frac{\Delta m_2}{\Delta m_1}\right) \quad (9)$$

$$\Delta l_1 = dl, l_0 = l_p, n(p) = \text{number of pairs} \quad \frac{dl}{2l_0} = \frac{dl}{l} = 2 \cdot dn(p)$$

$$2 \cdot \int_{l_0}^{l_1} \frac{dl}{l} = 2 \cdot \int dn(p) \quad 2 \cdot n(p) = 2 \left| \ln\left(\frac{l_1}{l_0}\right) \right| = 2 \ln\left(\frac{m_p}{m_1}\right) \quad (11)$$

$$\text{Four dimensions} \quad l_\gamma^2 + l_p^2(7D) + R_H^2(7D) + \pi^2 = \ln[(m_p/m_H)(\pi/4)]$$

$$\text{Eight dimensions} \quad 2(l_\gamma^2 + l_p^2(7D) + R_H^2(7D) + \pi^2) = 2 \ln[(m_p/m_H)(\pi/4)]$$

Where $\pi/4$ is the partition of the circle corresponding to the eight dimensions. Eight dimensions obtained by the square of the negative and positive values of the radius that have been shown. Negative values correspond to the inverse of the negative curvatures of the spheres inside.

$$\left(\sqrt{l_\gamma^2 + l_p^2(7D) + R_H^2(7D) + \pi^2} + \ln \sum_{n=1}^6 F_n \right) \cong \sqrt{l_p^2(26) + R_H^2(26D)} \cong (\sum_{n=1}^6 \sqrt{F_n} - 1) + \exp -[\rho^{-1}(K(8D))]$$

And that is indeed, regardless very small effects of quantic corrections.

The sums of the masses of the quarks in relation to the mass of the Higgs boson (the lightest) and the sum of the masses of the leptons and the Z boson, W, photon, in relation to the same mass, can be expressed in terms of the groups SU(3) and SU(2), as:

$$\left(\sum_q m_q \right) = m_H / \sin(3 \cdot 2\pi/24) = \sqrt{2} m_H$$

$$\left(\sum_B m_B \right) + \left(\sum_l m_l \right) = m_Z + m_{W^+} + m_{W^-} + m_\gamma + m_e + m_\mu + m_\tau + 3m_\nu$$

$$\left(\sum_B m_B \right) + \left(\sum_l m_l \right) = m_H / \sin(2 \cdot 2\pi/24) \cos(2\pi/60)$$

The Higgs boson mass is also expressed, it seems, by:

$$24 = 8 \cdot 3, 8 + 3 = 11D$$

$$(K(24D) / \tan(2\pi/24)) [\sin(2\pi/5) \sin(3 \cdot 2\pi/24) \sin(2 \cdot 2\pi/24)] + F_{13} = m_H / m_e = 247040$$

$$(196560 / \tan(2\pi/24)) [\sin(2\pi/5) \sin(3 \cdot 2\pi/24) \sin(2 \cdot 2\pi/24)] + F_{13} = m_H / m_e = 247040$$

$$F_{13} = \text{thirteenth Fibonacci number} = 377, \quad \left[\varphi^{13} + 1 \right] = \sum_{d=1}^8 K(d) = 522 = 496 + 26, \quad K(d) = \text{kissing number}$$

$$247040 / \left(\sum_l m_l \right) / m_e \cong \exp(8 \ln 2 / \sqrt{3} + 1) + \rho(K(8D))$$

$$m_H / (\sum_l m_l) \cong (\alpha^{-1}/2) - \sqrt{-l_p(7D) \cos(2\pi/\varphi^2)} \quad , \quad \varphi = \text{Golden ratio}$$

Barely a few days, has been measured with greater precision the W boson mass. With this value, with an estimated error of about 19 MeV, seems to set the cosine of the Weinberg angle as a function of an array of four non-zero spins, and isomorphic to the quantity of items in the multiplication table of quaternions, and possibly isomorphic to the matrix generated by the quantity of Higgs bosons. The sinus of same angle is also dependent of the sixteen matrix elements.

1. $m_w = 80.378 \text{ Gev} \pm 19 \text{ Mev} \quad ; \quad m_Z = 91.1876 \text{ Gev} \quad ; \quad (m_Z/m_W) = \cos^{-1} \theta_w$
2. $\sin^{-16} \theta_w / [l_p^{-1}(7D) + R_H^{-1}(7D)] \cong 247040 = m_H/m_e$
3. $\sqrt[16]{(1^2 + 2^2 + 3^2 + 4^2)/4} \cong \cos^{-1} \theta_w$
4. $\sqrt[4]{\exp(\cos^{-16} \theta_w)} \cong [R_H(26) + l_p(26)]/2$

The 4D fractal dimension of space-time should be $(2 + \sqrt{5}) = \varphi^3$

$$\varphi^3 = [4 ; 4, 4, 4, 4, 4, \dots]$$

If this fractal dimension has this value, then the fine structure constant should be a function of the fractal dimension.

$$\alpha = 2 \exp(\varphi^3) - [\tan^{-2}(3\pi/10) + \sin(2\pi/8)] + 11^2/(240 \cdot 10)^2$$

Increasing the radius Pi to the radius of the light, seems to have a very close relationship with the phenomenon of inflation. An increase in wavelength, string, etc., involves a decrease in energy (emission?): This increase or oscillation appears to be fairly accurately expressed as:

1. $\pi / \sin^2(\pi^2/2) = 3.3022723740283 = 2\pi/(1 - \cos \pi^2) \cong l_\gamma = 3.30226866228015 \quad , \quad \cos \pi^2 \cong 26/2 \quad - [(\alpha^{-1} - 137)^{-1} + (2/\pi)^8]/2 \cong 1 - \Omega_v^{-2}$
2. $\pi / \sin^2(\pi^2/2) - (m_e/\sqrt[8]{2}m_H) = \pi / \sin^2(\pi^2/2) - 1/(247040 \sqrt[8]{2}) = 3.30226866206243$
3. $l_\gamma \cos^2 2\theta_{13} = R_H(7D) = l_\gamma(1 + \cos 4\theta_{13})/2 \quad , \quad 4\theta_{13} = \theta_w(GUT)$
4. $l_\gamma - (1 - \sqrt{\alpha^{-1}/240}) = 3.0579030510666 \cong l_p(7D)$
5. $R_H(26D)/l_p(26D) \cong \cos^2 \theta_{13}$
6. $[\sin^{-2}(2\theta_{13})4\pi - \cos^{32}(2\theta_{13})] \cong 120 \quad , \quad \sin^{-2}(2\theta_{13}) = l_\gamma/(l_\gamma - R_H(7D))$
7. $[\sin^{-2}(2\theta_{13})4\pi] \cong [(\ln \dim[SU(4)] - 1)^{-2} + 240]/2$
8. $(\ln(\dim[SU(4)] - 1)^{1/2} \cong \exp - (\frac{26^2}{10^2} [1 + \ln^{-1} 26]) + [(1/5 + 1/14 + 1/39 + 1/103) + 1] \text{ (Table I)} \quad , \quad (1/5 + 1/14 + 1/39 + 1/103) + 1 = \Delta$

9. $[\ln^2(m_H/m_e)\rho(K(3D))]/\sin^2(\pi^2/2) - [\Delta - (10^2\Delta^{16})^{-1}]^{-16} = 120$
10. $\dim[SU(3)] + \dim[SU(2)] + \dim[U(1)] = K(3D) = 12$
11. Sphere surface 26D: $S_s(26D) = (l_p^{25}(26D)\pi^{13})/239500800$
12. $(\ln(S_s(26D)/l_p(26D))^{-4} + K(3D) + (2^{-2} + 3^{-2} + 5^{-2} + 8^{-2})) = \ln(m_H/m_e) = \ln(247040) , 2 \cdot 3 \cdot 5 \cdot 8 = 240$
13. $\text{radius} = \pi , 4\pi(\pi^2)/\cos^{16}\theta_{13} - 1/R_H^2(26D) = \ln^2(m_H/m_e)$
14. $\tan(\arccos[\exp\{\ln(\pi^2/2) - (\ln \pi + 1)\}]) \cong (\ln(\dim[SU(4)]) - 2)^{-1} = 1/(\ln(15.000005944323) - 2)$
15. $\left(\frac{24}{K(2D)}\right) / \rho(K(3D)) + \sqrt{\left(\frac{24}{K(2D)}\right)} - \ln^{-1} 4 = m_Z/m_e + \sum_l m_l/m_e$
16. $3(\text{colours})(\sum_q m_q)/m_e + (\sum_l m_l)/m_e + (m_Z + m_{W_+} + m_{W_-} + m_\gamma)/m_e \cong [K(3D)/K(1D) = K(2D)^8/\ln(\pi^2/2) \cong \exp(13 + \cos(2\pi/12))$

9 Geometric equations of state

In conclusion, we present a geometric equations related to each other can be derived from an equation of state, which clearly indicates that the center of the torus of the superparticle has a charge of the same sign as the surface of the torus. This repulsion is probably generates instability in the superparticle, and subsequent superluminal inflation.

Possibly, this equation is a partial result of a fundamental equation or equations that fully describe all the features of the superparticle.

- geometric equation of state of the superparticle, no time-dependent:

1. $f(R_H(7D)) = f(x) = V_{\text{sphere}}[4D(R_H(7D))] = R_H^4(7D)\pi^2/2$
2. $f(x) - f'(x)(2l_p(7D)/x^2) + \sin^2 2\theta_{13} = \sqrt{\hbar}/\pi e_\pm ; \sin^2 2\theta_{13} = (l_\gamma - x)/l_\gamma$
3. $f(x) \cos 2\theta_{13} \cong f'(x)(2l_p(7D)/x^2)$

Derived expressions: guess

- $2l_p(7D)/x^2 \cong \cos \theta_1 / \cos^2(2\pi/60)$
- $f(x) - (\sinh(\pi^2/2) + \cosh(\pi^2/2)) + (\alpha/\rho[K(24D)]) - 2 = 240 ; \rho[K(24D)] = \text{density sphere packing } 24D$
- $\rho[K(24D)] = \pi^{12}/12!$

- $\ln(m_p/m_v) = (70 + \sin \theta_1/2)$; $\ln^2(m_p/m_v) + (\hbar/e_{\pm}^2) - K^{-1/2}(x, \theta_{\varphi}) = 24f(x)$; $K(x, \theta_{\varphi}) = (\cos \theta_{\varphi}/(x \cos \theta_{\varphi} + l_p(7D))x)$

$$\theta_{\varphi} = 2\pi - (2\pi/\varphi^2) \ ; \ \varphi = \text{Golden ratio}$$

- windings due to the squares of the imaginary octonions 7 for the sum of the inner and outer surfaces of the torus: $7 \cdot 2 \cdot f_l(x)(2l_p(7D)/x^2)$

- $(\ln[-24f(x) + 7 \cdot 2 \cdot f_l(x)(2l_p(7D)/x^2) + \hbar/e_{\pm}^2]/10)(\sinh(\pi^2/2) + \cosh(\pi^2/2)) \cong \ln 24!$

- $(l_{\gamma}^2 8 \ln 2/\sqrt{3}) \sum_s \sqrt{s(s+1)} + \sqrt{\sum_s \sqrt{s(s+1)}} + 2(\sin 2\theta_{13} + 1) = 240$

- $2\pi \sum_{\bar{S}} \Delta(\sqrt{s(s+1)} + \sin^4 \theta_{Td} \cong \sqrt{\hbar}/e_{\pm})$; $\theta_{Td} = \text{Angle between and edge and a face of regular tetrahedron}$

- $7 \cdot 2 \cdot f_l(x)(2l_p(7D)/x^2) - \pi^4 - \tan^2 2\theta_{13} = 70^2 = \sum_{n=1}^{24} n^2$

- $\sin \theta_w + \cos^2 \theta_w \cong \ln^2 l_p(7D)$

- $\sin^2 \theta_{13} \cong 4\pi/(120 - \ln \ln l_p(7D))$

- $f(x) - (1 - 2 \sin^2 \hat{\theta}(m_Z) (\overline{MS})) = (3/2)^6 S_{sphere}(7D) = (3/2)^6 16\pi^3/15$

- $2(\rho^{-1}[K(24D)]/\alpha^{-1} + 1) \cong \sin^{-2} \theta_{13}$

- Sphere surface 10D $r^9 \pi^5/12 \quad \ln(7 \cdot 7^9 \pi^5/12) + 3l_p^2(7D)x + 3x^2 l_p(7D) + x^3 + l_p^3(7D) - \left(\frac{\sqrt{5}-1}{\sqrt{5}}\right)^2 = 240$

- $3l_p^2(7D)x + 3x^2 l_p(7D) + x^3 + l_p^3(7D) + (\sqrt{3} + 3)^2 = 240$

- The Monster group $4 \cdot O_r(M) \cong \sin 2\theta_{13} \cdot 10^{55}$

- $\beta = \left(10^{55} \sqrt{\exp -[(1/x + 1/l_p(7D))^{-2}]}\right)/4$; $\ln \beta + [240x^2 - (1/x + 1/l_p(7D))]^{-1} = \ln(O_r(M))$

- Oscillation of the light radius l_{γ} ; $4\pi l_{\gamma}^2 = \alpha^{-1}$

- $\pi/\sin^2(\pi^2/2) \cong l_{\gamma} \quad \pi \cos(\pi^2/2) \cong \cos \theta_1$

- $\pi/\sin^2(\pi^2/2) - [\rho^{-1}[K(24D)] + \ln(\sqrt{5})]^{-2} \cong l_{\gamma}$

- $1 + \sin^2(\pi^2/2) \cong m(V_H)/m_H$

- $l_{\gamma} = [\pi/\sin^2(\pi^2/2)] - 1/\sqrt[8]{2}(m_H/m_e)$

- Oscillation of radius π

- $\pi + \sin(\pi^2/2) \cong (1 + \sin \theta_w)^2$

- $\pi - \tan(\pi^2/2) + 2 \cong \sin^{-1}(2\pi/60)$

- $\pi^2/2 + \sqrt{\pi + \sin(\pi^2/2) - 1} + \exp -[\sinh([\ln 240 - 4]^2) + \cosh([\ln 240 - 4]^2)] \cong x + l_p(7D) \cong x + l_p(7D)$
- Summations in function of prime numbers contained in the intervals: $\pi(137)$; $\pi(240)$
- $\pi(137) = 33 = \sum_{n=1}^8 F_n \quad \sum_{p \leq 137} p^2 = (m_z/m_e) - (m_e + m_\mu + m_\tau/m_e) - \pi/4 = 174764$
- $\pi(240) = 26 \cdot 2 = \dim(F4)$
- $\sum_{p \leq 240} p^2 = 874695$; $(\sum_{p \leq 240} p^2)/(1 + \cos \theta_w)^2 = m_H/m_e = 247040$
- $\sum_{p \leq 240} p = 5589 = \sum_{n=1}^{24} n^2 + 2(4\pi^2 x^2) - (1 + \Omega_v/2)$
- Lengths 26 dimensions
- $\ln(60!/26!) - (18^2/10^2) \cong \ln(O_r(M))$
- $\ln(60!/26!) - (2^7 - 1) + \sqrt{\sum_{n=1}^{24} n^2} = 40^2 - \ln^2(m_p/m_H)$
- $R_H(26) = R_H(26)/l_p = \left(4(2\pi)^{26} / \left[2\pi^{26/2}/\Gamma(26/2)\right] \cdot (26 + 1)\right)^{\frac{1}{26+1}} = 6.43989730373194$
- $l_p(26) = \left(2(2\pi)^{26} / \left[2\pi^{26/2}/\Gamma(26/2)\right]\right)^{\frac{1}{26+2}} = 6.61240539117563$
- Sphere surface 26D $l_p^{25}(26) \left(2\pi^{26/2}/\Gamma(26/2)\right) = S_s(26D)$
- $\exp\left([\ln(S_s(26D))R_H^2(26)]^{-1} + \ln(26) + 10\right) + [\ln(l_p(26)) + 1]/10 = \sqrt[4]{2}(\text{mass higgs empty})/m_e$
- $\sqrt[4]{2}(\text{mass higgs empty})/m_e = 481842.934\sqrt[4]{2}$
- $\ln \varphi \cdot (1 + 2 + 3 + 4)^{(1+2+3)} + \exp(R_H(26)) + \ln 3 \ln(l_p^4(7D)) = (\text{mass higgs empty})/m_e$

10 Conclusión

The intent of this humble investagación was not go as far as the end it was. I honestly think it has been shown that the existence of God is a scientific fact and must be deducted. We think also that there is a topology, geometry Characteristics of a special, unique solution. This geometry underlying that determines all the properties of our physical universe. A universe in an infinite dimensional space, which in turn determines how our universe only possible four-dimensional extended (includes time), and seven other compacted. The distinction made by the observers, depending on the scale of energy, of mass energy, space and time, is merely produced by the different geometric configurations, this topological space. The same uncertainty principle of Heisenberg shows the inseparability of space-time-energy-mass. All quantified length of space is inseparable from a certain amount of energy-mass, because the same

mass-energy is merely a geometric-topological configuration different from this same spacetime. Similarly, the electric charge, color charge, etc., are properties and / or geometric topological invariants. All these geometric and topological properties are derived, we think, single number: 10565, the sum of its digits gives the number 26 ($10 + 5 + 6 + 5$). And this number is the name of God, of his letters: YHVH In Hebrew, for over 2000 years, these letters have a value. Y = 10, H = 5, V = 6, H = 10. This number 10 5 6 5 and the sum of its digits, contains in itself all that is shown in this work. This is not the objective of this research, and escaping from what man can understand scientifically. In short: God created everything that exists with its own name. It may sound crazy, but it is so. The numbers in the Fibonacci series contain a connexion with our physical world, of which we currently only able to glimpse some features. Again, our intention was not to reach so far, but we think this humble work contains some, possibly, the skeleton of a theory of unification.

References

- [1] Black holes and the existence of extra dimensions, Rosemarie Aben, Milenna van Dijk, Nanne Louw
- [2] Particle Data Group, http://pdg.lbl.gov/2011/html/computer_read.html