

# **On the Structure of Matter**

**Contents:**

**1. Introduction**

**2. Assumptions**

**3. Logarithmic Spirals**

**4. Explained Phenomena**

**5. Alternative Model of the Hydrogen Atom**

**5.1 Structure**

**5.2 Stability**

**5.3 Electric Charges**

**5.4 Magnetic Monopoles**

**5.5 Spectral Lines**

**6. Symmetries**

**6.1 Neutron Decay**

**6.2 Spin**

**6.3 Antimatter**

**6.4 Time Arrow**

**7. Alternative Standard Model**

**8. Conclusions**

**Appendix Alternative Standard Model**

## **1. Introduction**

The current worldview is based on the assumption that all matter formed shortly after the Big Bang in virtually one event and that its elementary components have remained unchanged since then. Nature is understood to consist of fixed, static quantum objects whose structures are independent of time, where particles with mass form localised, closed systems, i.e. possess a radius. Matter exists alongside space-time. This static point of view leads to a profusion of phenomena which are not understood, to postulates instead of proofs, to fundamental contradictions between quantum theory and classical physics, to an ever-increasing number of free parameters in the mathematical formalisms, and to a breakdown of the GTR (General Theory of Relativity) and QT (Quantum Theory) when describing nature on the scale of the Planck length.

The paper develops a fundamentally new understanding of how nature works, where matter in its manifestations is considered not to be constant, but the result of continuous energy flows. Matter does not exist alongside space-time, it is its component. A quantum object only seems to be invariable, and the impression of being able to observe the same quantum object continuously, independent of time, is deceptive. Space-time and the quantum objects embedded in it cease to exist and are formed anew at every point in time. Its structures are not localised as a rule.

This paradigm shift towards a dynamic perspective allows a consistent description of nature across all ranges of scale. Breaks and contradictions between quantum theory, Newtonian theory, the GTR and cosmology disappear. A uniform, self-contained worldview is created.

The concept introduced is linked directly to the world within our experience and is therefore relatively easy to verify. This is facilitated by the fact that it is associated with a fundamental simplification of physics because the number of free parameters is drastically reduced.

The alternative structure of the quantum objects and how they function is explained using the example of the hydrogen atom.

The author sees the far-reaching consequences of the concept presented for other scientific fields, including cosmology, but this paper does not deal with further considerations.

## **2. Assumptions**

Central to the development of an alternative model of nature is the reassessment of known phenomena such that unimpeachable observations (raw data) do not enter into considerations as interpretations, i.e. they are not subjectively assessed (processed), as happens in the generally acknowledged theories, but are regarded as objectively given. All postulates are avoided.

**Firstly:** Complex numbers are not a peculiarity of mathematics. Rather, real numbers are a special case of complex numbers. Complex values, and thus the wave function as well, mirror physical reality. Quantum objects thus have a complex structure. This assumption is supported by the fact that complex numbers are not simply a more elegant way of describing the physical phenomena and a multitude of other fundamental phenomena at the quantum level, they are the only way of describing them.

From these statements follows the existence of a complex universe, consisting of two, real and imaginary worlds mutually giving rise to and continuously forming each other. Events involving mass in the imaginary world are not observable from the point of view of our real world and cannot be measured, but they exist. In the case of massless electromagnetic quanta and fields which propagate with the speed of light, the imaginary region and the real region coincide. We can observe and measure them as complex structures and events. This primal symmetry between the two worlds forms the central system of nature. It is the basis of the CPT symmetries and conservation laws. They are manifestations of this primal symmetry.

**Secondly:** Energy is also symmetrical. The positive and negative energy values  $E = \pm\sqrt{m^2+p^2}$  which result from the energy-momentum relation of the Klein-Gordon equation correspond to physical reality. There are thus two types of energy in the form of positive energy (+E) and negative energy (-E). These types of energy correspond to the terms electric and magnetic. (The negative energy therefore has nothing to do with Guth's negative energy of the gravitational field). The two types of energy can perform the same work. Their work capacity is the same. Both types of energy flow in continuous flows towards or away from the complex universe, the equilibrium of real and imaginary universes.

The total energy of the complex universe overall and of each of its complex structures is always equal to zero. The endeavours of all systems to reach this state determine the structures and the processes of nature.

**Thirdly:** The curvature of space-time (ST) is the expression of different ST densities.

Space thus not only has geometric properties which link space, time and matter. Space is energy and its geometry is a function of this energy. It thus follows that ST is a form of energy. ST thus becomes a structured medium to an (albeit extremely weak, but quite normal) electromagnetic field. It is therefore no longer a passive volume wherein processes occur, but an active, dynamic component of all processes. Since ST is a form of energy, the equation  $E=m*c^2$  applies to it. ST can therefore convert into mass and mass into ST. ST (the space-time field) is formed by ever-decreasing energy packets in the form of electromagnetic quanta. For practical reasons a smallest quantum can be defined, which represents an energy packet of  $6.6*10^{-34}$  joules (cut-off). This quantum is termed a space-time quantum (STQ) below. STQs are therefore the structure which can explain the formation of the whole universe with space, time and matter.

**Fourth:** The occurrence of vast numbers of logarithmic spirals in nature and engineering, and the similarities between the description of quantum objects and the properties of such spirals (infinite range of the wave function, right and left rotation of quantum objects (spin), wave-particle duality, comparable with the wave-like character of the spiral arm, and the high density of the central region of a logarithmic spiral) point to the pivotal role which logarithmic spirals play in the organisation of nature.

This results in the assumption that all components of the nature which surrounds us, all quantum objects including the STQs, consist of energy flows in the form of logarithmic spirals and that these thus form the fundamental structure of nature.

In reality they are three-dimensional (conical) spirals. For reasons of simplicity only two-dimensional (flat) spirals are considered below.

### 3. Logarithmic Spirals

Logarithmic spirals are self-similar structures which are symmetric under similarity transformation with unique properties:

They coil themselves around in the centre an infinite number of times and thus approach a point which approaches zero, but always remains finite. In mathematical terms this is an approach to an asymptotic point.

In physical terms it is a “finite singularity”, a state which always remains calculable and results in finite values (no singularity problem). Up to three singularities of this type can occur at one point. Towards the outside the logarithmic spiral extends to infinity.

In mathematical terms, the logarithmic spiral is a curve with constant gradient which can be differentiated or integrated any number of times without changing. Only the reference point on the curve and thus the scale changes with every operation.

In physical terms this means that, in a nature which is organised according to this principle, a natural law which is valid on an arbitrary section of the spiral must apply everywhere, i.e. it must be valid on all scales from the micro-scale through to cosmic dimensions, that natural laws are scale-invariant and there can be no ranges of validity.

In mathematical terms the logarithmic spiral is a curve whose curvature increases exponentially towards the axis of rotation.

In physical terms the (flat) logarithmic spiral describes an “energy string” of STQ which rotates around the centre and becomes exponentially denser and denser towards it. (In reality, the spiral arms are funnels similar to tornado spouts which become infinitely wide towards infinity and become one-dimensional strings towards the centre (asymptotic point). The logarithmic spiral is thus a two-dimensional spiral or vortical field. For electric spirals (eS) the STQs move from a “singularity” towards infinity. These spirals therefore generate a local excess of space-time. Magnetic spirals (mS), in contrast, consist of STQs which flow in the opposite direction, i.e. towards the centre of the spirals into a “singularity”. They generate a local deficiency of space-time. The space-time densities produced by this mechanism, which are spatially and temporally different, and the endeavours of eS and mS to “short-circuit” so that energy can flow along the shortest route from the eS of one quantum object into the mS of another quantum object, lead to a “primal force” which manifests itself as the familiar interactions. All interactions are therefore variations on the same force which simply manifests itself on different scales, in different regions of the spirals. (The mechanism is explained using the example of electric attraction).

The logarithmic spiral can be described in polar coordinates by the function  $r = r_0 \cdot e^{(k \cdot \varphi)}$ , where  $r$  is the radius from the coordinate origin to the point under consideration.  $r_0$  is the radius of a starting point on the polar axis from which its further course can be observed and thus enables the spiral to be scaled so that a meaningful section of the picture can be obtained.

If  $\varphi > 0$ , a point on the spiral moves away from the centre; in terms of its direction of motion, it is an outwardly rotating spiral. If  $\varphi < 0$ , the spiral approaches the central point, it is an inwardly rotating spiral.

The factor  $k$  describes the gradient of the spiral. It is of crucial importance for the description of the processes in the quantum objects.

The closer  $k$  gets to zero, the closer together are the spiral arms. In the range of distances from the axis of rotation considered by quantum mechanics, the distances between adjacent turnings are approximately constant for low  $k$  values, and the energy flow can be approximated by the wave motion of a one-dimensional string.

Since spiral variations are mentioned repeatedly below, the following abbreviations and symbols are assigned to them for the sake of simplicity:

Inwardly turning spiral = magnetic spiral (mS)  $\rightarrow\bullet\leftarrow$  .

Outwardly turning spiral = electric spiral (eS)  $\leftarrow\bullet\rightarrow$  .

Right-handed spiral  $\rightarrow\bullet\text{---}R$  . Left-handed spiral  $\rightarrow\bullet\text{---}L$  .

#### 4. Explained Phenomena

As the not yet understood phenomena below show, describing the quantum objects as spiral energy flows (as vortical fields) leads to the immediate clarification of a large number of fundamental problems of quantum physics:

##### 4.1 Energy

The energy turns out to be a measure of the distance of a physical system from the equilibrium of the complex universe, a state without space, without time and without energy, i.e. as a distance from nothing. The endeavour of all physical systems to reach this state of zero energy becomes the fundamental law of motion for matter.

##### 4.2 Mass

Mass forms in the central region of electromagnetic vortical fields starting from a defined energy density. Mass is thus the manifestation of an electromagnetic field with an extremely high energy density, i.e. extremely compressed space-time. The energy density of the electromagnetic quantum beam becomes the electromagnetic mass density. The mechanism by which the mass is formed can be described using the example of an mS as follows: as it approaches the central region, the energy density in the spiral arm increases exponentially and the speed of the STQ decreases. When a certain distance from the axis of rotation is reached, the speed drops below a certain value, massive quanta are formed. The quanta which arrive subsequently push the now massive quanta to ever-lower orbits, and are decelerated further in the process. Their speed decreases from turning to turning as their mass increases. In the immediate vicinity of the axis of rotation, the speed of the quanta is close to zero in a volume which tends to zero and the mass/energy density is almost infinite. Mass is therefore formed by the deceleration of electromagnetic quanta and is made up of a series of shells.

### **4.3. Wave-Particle Duality**

The Copenhagen interpretation states that quantum objects are particles as well as waves. The experimental setup determines whether the particle or the wave properties of a quantum object are imaged. Their structure and thus the mechanism whereby particle or wave properties are formed have so far remained a mystery. Describing quantum objects as energy flows in the form of logarithmic spirals means duality becomes classical physics: the central region of the quanta with its high energy density represents the particle character with defined momentum and precisely measurable spatial coordinates.

The higher the energy density, the greater is the mass field present in every quantum, the lower its speed (of light) and the more evident the particle characteristic (the speed of electromagnetic quanta is therefore not a constant). This leads in consequence to De Broglie's matter waves.

The spiral arms extending to infinity represent the wave character of the quanta. The spiral arms can be approximated to a wave because the gradient  $k$  of the spirals is very small, so that in the range considered by quantum mechanics the separations between two subsequent spiral turnings remain virtually the same and can be described as a wavelength. ( $E = h \cdot c / \lambda$  is the approximation for  $E = h \cdot c / a \cdot k$ , where  $a$  is a proportionality factor). Particle-wave duality thus simply considers different regions of the same logarithmic spiral, from which it follows that if the parameters of the wave (the spiral) are known, precise statements on the "particle region" can also be made, and vice versa. This also makes the physical character of the wave function comprehensible: it is an image, an approximation of the overall (real) energy spiral(s) or a part thereof as a wave, and thus contains the complete (real) information on a complex quantum object.

### **4.4 Quantum Entanglement**

Quantum entanglement turns out to be the interaction between the spiral arms of two or more quanta. The simplest case is formed by two simultaneously created light quanta moving in opposite directions which are "linked" to each other via their spiral fields. At close range, they can be described as a quantum-mechanical state. This does not apply to larger distances, however, because the entanglement decreases exponentially with increasing distance. Typical cases of entanglement are electromagnetic fields (e.g. light rays), electric and magnetic fields, the bonds within atomic nuclei, and the chemical bonds between the atoms.

### **4.5. Quantum Fluctuations**

The quantum fluctuations of the vacuum turn out to be disturbances of the (extremely weak) space-time field by the (real) spiral arm segments of quantum objects located in an arbitrary volume. Superpositioning processes (of temporally or spatially coherent segments of the spiral arm) lead to extraordinarily dynamic spatial and temporal changes in the number of STQ in the volume under consideration, i.e. to changes of the space-time density and therefore the local energy density. It is these density changes which lead to interactions with the quantum objects which are in the volume observed. There is therefore no need for virtual particle-antiparticle pairs which form out of nothing and annihilate each other immediately (and thus no local violation of the energy conservation law) to explain the vacuum fluctuation.

#### **4.5 “Aether”**

Since the space-time field moves with the speed of light and quantum objects are nothing but small or large local disturbances of this field, all (almost) massless quanta move not in but **with** this field. Light is therefore a wave of STQ (the wave function of quantum mechanics describes precisely this fact). “Aether” as a medium does not exist, but there is a wave-like quantum field consisting of energy vortices which structures space.

#### **4.7. Modes of Oscillation**

While the (almost) massless quanta move with the field and can therefore have only two modes of oscillation, massive quantum objects have a much lower speed, have a “slip” with respect to the space-time field, and can therefore oscillate in three planes. Or expressed in another way: while the difference between real and imaginary regions can be neglected for low-energy electromagnetic quanta and they therefore move in both worlds, massive quantum objects are fixed in their worlds such that the greater their energy, the stronger this fixation.

#### **4.8. Uncertainty**

The uncertainty of quantum states, the impossibility of determining the dimension of a pair of values which have an effect, such as momentum and position, or energy and time, simultaneously and accurately, and the probability statements of quantum theory turn out not to be an intrinsic property of the micro-world, but the result of the quantum fluctuation, the interaction of a quantum object under observation with an electromagnetic field of similar strength. Just as in thermodynamics the pressure in a vessel is a statistical quantity, but one which could, in principle, be calculated exactly, i.e. with knowledge of the states of the individual gas molecules, the states of quantum objects can also be exactly determined in principle, which equals the restoration of determinism and the causality principle in the quantum world.

The example of the hydrogen atom is now used to show that all matter can be represented by the combination of a maximum of three spiral fields. Further phenomena are discussed in this context.

### **5. Alternative Model of the Hydrogen Atom \***

#### **5.1. Structure**

Experimental data shows that the nucleus of the hydrogen atom or the proton consists of three quarks, two up quarks and one down quark. It has also been proved that the proton is not spherical. Translating this fact into a spiral structure leads to the assumption that the two up quarks are eS and the down quark is an mS, their central regions being compressed to mass. Each of the spirals can rotate about its own axis or they can all rotate about a common axis. The spatial arrangement of the three spirals must be as symmetrical as possible for energetic reasons. This only applies to two structures:

\* The determination of the precise parameters is reserved for the mathematical simulation.



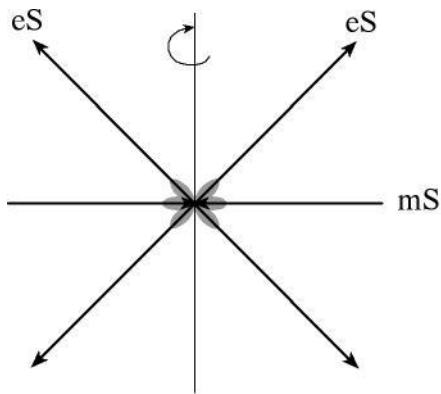

Fig. 1a

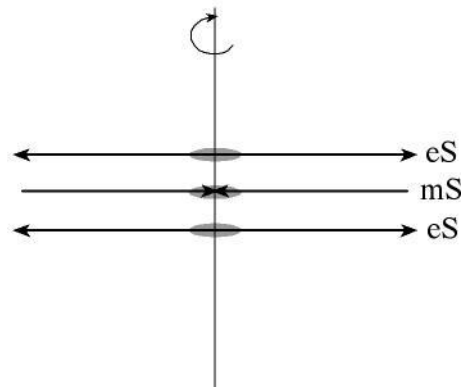

Fig. 1b

We will see later how the two structures are realised in nature; structure 1a as the hydrogen atom and structure 1b as the proton.

In Figure 1a the two eS are arranged symmetrically to the mS, forming an angle of  $90^\circ$  between them. Their centres are in the immediate vicinity of the centre of the mS. In Figure 1b one of the two eS runs above and one below, parallel to the mS. All three spirals rotate about the same axis.

In contrast to current ideas about the atom, this hydrogen atom contains neither a proton nor an electron. As is also described by the wave function, it has no bounds and extends into infinity.

Let us now look at the structure of the hydrogen atom in more detail.

From the two centres of the eS constant energy flows in the form of STQs move in the direction of space-time, i.e. in the direction of infinity. The structure of the eS is therefore constant. Neither the diameter of the mass disc (of the up quarks) nor the gradient of the spirals changes, the structures of the eS are independent of time.

In contrast to the eS, the mS “sucks in” energy from the direction of space-time, STQs move towards the axis of rotation. In equilibrium, the energy flowing in in the real region and the energy flowing out through the central opening (tunnel) into the imaginary region are equal. The energy flowing in increases the pressure around the axis of rotation such that a link, a tunnel between the real and the imaginary world, is created and energy can flow between the two worlds, i.e. is exchanged between our real world and the imaginary world. Towards these tunnels space-time asymptotically approaches zero, but remains finite, and the energy asymptotically approaches infinity, but always remains a finite quantity. The centres of the spirals are therefore “finite singularities”. Singularities are therefore not the exception but the rule in nature. In the micro-world they are in the centre of quantum objects, in the macro-world in the centre of black holes.

This now poses the question as to what happens if, in the real region, more energy temporarily flows into the mS than can flow out through the tunnel (with constant diameter). The answer is: the energy is intermediately stored by the gradient of the mS decreasing and thus the radius of the mass disc increasing.

This means that the extra energy introduced is stored intermediately as mass (this process will be discussed in more detail below). The structures of the mS are therefore time-dependent. The mass of “elementary particles” is therefore not constant, but depends on their excitation state. (The mass of the down quarks/(mS) should therefore be temperature dependent and in the ground state at 0 K correspond to that of the up quark/(eS)). (Currently, the ground state of an atom is defined by the lowest possible energy level of the orbital electrons). This would also explain why the measurement error for the down quark is greater than for the up quark (up quark 1.5-3.3 eV/c<sup>2</sup>, down quark 3.5-6.0 eV/c<sup>2</sup>).

On the imaginary “rear” of the hydrogen atom there is a mirror structure, where the reverse processes occur. Instead of the two eS there are two mS, in which the energy flows towards the centre, and instead of the mS there is one eS, in which the energy which flows in in the real mS flows out. In other words: on the imaginary rear of the hydrogen atom there are two down quarks and one up quark, i.e. one neutron. The latter explains why the neutron is slightly heavier than the proton, incidentally: at the same ambient temperature, i.e. the same excitation state, the two mS in the neutron intermediately store twice as much energy as the proton with only one mS.

## 5.2. Stability

What is the explanation for the fact that the atomic structure presented remains permanently stable? Which forces or which force can bring this about? It is currently assumed that for distances less than 10<sup>-14</sup> metres the Coulomb repulsion of the protons is compensated by an even stronger attraction in order for the nucleus (of composite atoms) to remain stable. This force, termed the strong interaction or strong nuclear force, is caused by the exchange of gluons (electrically neutral, massless particles) between the nucleons. In addition to an extremely short range this force is supposed to have a property which cannot be observed anywhere else in nature: it increases with distance, but approaches a fixed value (QCD). All other forces known to us become weaker as the separation between the interacting objects increases. In the structure of the hydrogen atom described above (as in composite atoms) the nuclear force is generated by a mechanism which is well-known from hydrodynamics: locally different flow velocities produce pressure differences which result in a force which pushes molecules of one medium into another medium with lower pressure. In the hydrogen atom, the energy flows flowing with different velocities (the velocity in the energy-rich spirals is lower than that of the weak space-time field) give rise to a force of attraction, often called suction effect, which keeps the three spirals together. The smaller the separation between the spiral arms and hence the velocity of the energy flows becomes, the stronger the “suction effect”, the strong nuclear force. At a distance of 10<sup>-14</sup> metres from the centre it is not detectable, but approaches infinity towards the axis of rotation. The formation mechanism of the strong nuclear force will be found again with the other interactions.

## 5.3 Electric Charges

The stronger the excitation state of the hydrogen atom (the larger its mass, the more specific the mass of the mS), the stronger the two eS are attracted towards the mS, the angle between the eS and the mS decreases.

If the excitation state reaches a certain value, the ionisation energy, the angle becomes so small that both eS fold in the direction of mS. Two new stable structures form, the proton and the electron:

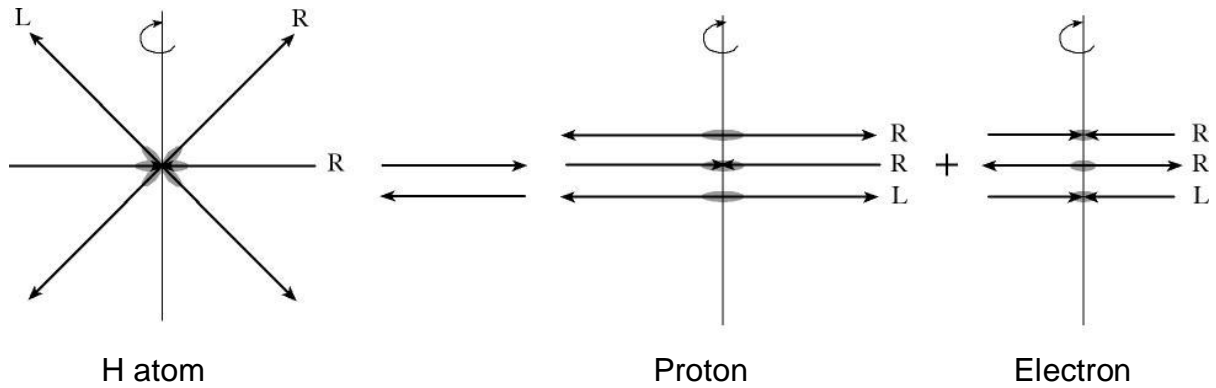

Fig. 2

opposite electric charges therefore always form simultaneously (the reason why the universe overall must be electrically neutral).

In both structures the three spirals are arranged parallel to each other and rotate about a common axis. The electron has a mirror proton structure, where the gradient of the spirals and thus the rest mass is lower than that of the proton spirals.

It is obvious that the electron is not an elementary point particle, as has been assumed so far, but possesses an internal structure. In this structure there is no room for an elementary charge or smaller charge carriers which together result in an elementary charge. And under no circumstances can this electron be understood as a kind of spherical capacitor on whose surface tiny charge carriers are distributed. If this is the case, there is only one plausible explanation for the phenomenon of the elementary charge: the three parallel vortical fields of the proton and the electron themselves cause the phenomenon of the electric charge. As will be shown later, the same applies to mirrored parallel vortical fields and magnetic charges as well.

The observation of quantised quantum Hall plateaux of  $e/3$  each (currently interpreted as new phases of matter) confirms this electron structure. It would be wrong to assign a charge of  $e/3$  to every vortical field, however. This is demonstrated by charged mesons which also possess an elementary charge, but which only consist of two parallel spirals. In this case, the elementary charge is therefore already generated by two parallel vortical fields, so that  $e/2$  would have to be assigned to each of them.

When a hydrogen atom is converted into a proton and an electron, two equally large, opposing elementary charges are created. An elementary electric field thus forms whose strength varies with the separation of the charges. If the energy excess of the electron is not sufficient for it to move far enough away from the proton, a recombination occurs.

Since proton and electron have been formed by the addition of energy and thus have more energy overall than the hydrogen atom, they strive to return to the H-structure by releasing the binding energy. This manifests itself in the attraction of opposite charges.

Like structures, in contrast, cannot form a new, energetically more favourable structure. Like charges therefore repel each other. Basically, it is not charges which generate electric and magnetic fields, but electromagnetic fields which give rise to the phenomenon of charges. The Coulomb force is therefore identical with the force with which the proton field and the electron field attract each other. The two fields can exist independently of each other, or jointly form an elementary electric force field. The same applies to the Lorentz force of moving charges and the electromagnetic field.

The schematic below illustrates the mechanism whereby the forces of attraction and repulsion are created:

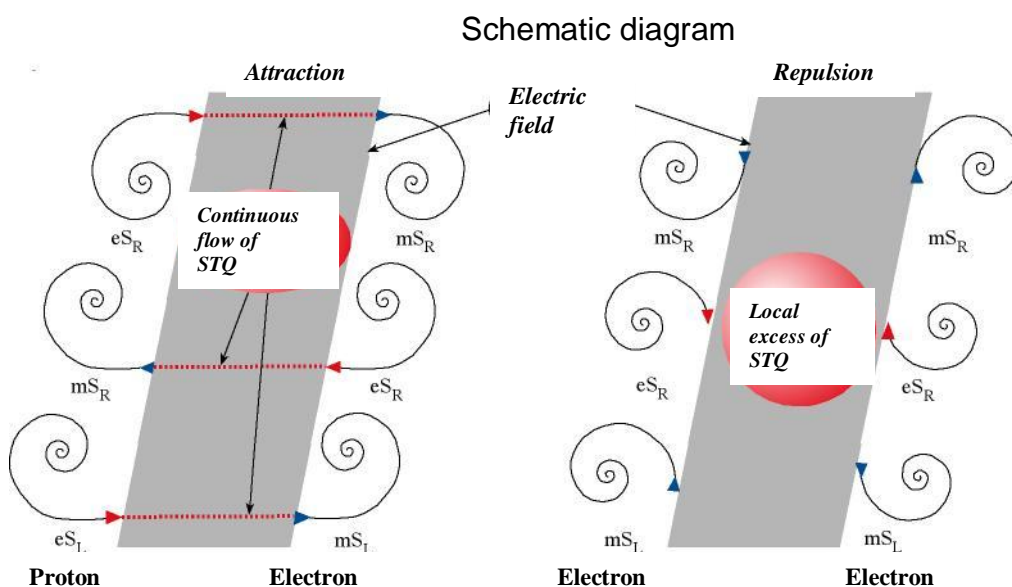

Fig. 3

As can be seen, the spiral arms shorten when opposite charges approach each other by forming double spirals. The energy of an eS does not flow to infinity, but directly into an mS. The connecting line which forms between the two spirals is the line of force of the electric field. The shorter this line, the stronger the field, the stronger the force of attraction. With charges of the same sign no double spirals can form and the eS cause a local ST excess which becomes larger and larger as the two quantum objects approach each other. The two charges repel each other. The same mirrored process leads to the attraction or repulsion of magnetic charges.

As can be seen, the electromagnetic interaction is also based on the same interplay of pressure and suction, of relative excess and relative lack of STQs, i.e. the same mechanism which creates the strong interaction. The electromagnetic force is therefore also a variation on one and the same primal force. (The treatment of the gravitational attraction would exceed the scope of this paper. It shall merely be noted that gravitation is caused by the “suction effect” of free mS arms due to the excess of neutrons which large masses have and thus due to the decrease of the space-time density).

### 5.4 Magnetic Monopoles

In the transition from one universe into the other mS become eS and vice versa. As has already been shown, at the imaginary “rear” of a real hydrogen atom with the eSeSmS structure there is therefore an imaginary neutron with the mSmSeS structure. The different quantum objects in the real and the imaginary world give rise to each other. This means that the same quantum objects must exist in both worlds. If a real electron is mirrored as an imaginary monopole S, an imaginary electron which is mirrored as a real monopole S in our real world also exists. The existence of charged monopoles thus derives from the existence of protons and electrons, and their structure from the structure of these quanta. The real process

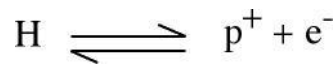

therefore goes hand in hand with the imaginary process

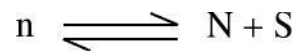

and vice versa.

The key to understanding the monopoles is as follows:

Electrical charges are formed when energy is supplied to a hydrogen atom and it is ionised, i.e.

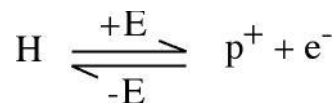

the recombination takes place with the energy being released.

Hydrogen is therefore a more stable system, a more stable structure, than the proton-electron structures. If more energy is supplied than is required for the ionisation of the hydrogen atom, the kinetic energy of the electron increases and it can leave a sample when its momentum exceeds a certain value.

After the ionisation of the hydrogen atom an elementary electric field is thus generated whose strength varies with the separation of the charges.

The mechanism whereby monopoles are generated proceeds the other way round. Energy must be removed from the (excited) neutron in order for it to decay into an N monopole and an S monopole.

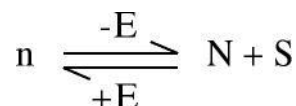

The energy is removed by an external magnetic field (magnetic energy is negative).

The monopoles therefore form along the force lines of an external magnetic field which penetrate a material.

If there are many (excited) neutrons on such a line of force, many monopole pairs (dipoles) are generated. These elemental magnets align as if on a chain and their field strength adds up to the total strength of the magnet like the voltage of batteries connected in series.

In a stationary magnetic field both charge carriers are therefore fixed to their position, the elementary magnetic field is constant, there is a non-zero magnetic charge density  $\rho_m$  between the two monopoles, the monopoles are source and sink ( $(\nabla \cdot \mathbf{B} = 4\pi\rho_m)$ , which causes the break in symmetry in relation to the electric field to disappear, while the magnetic macro-field always remains source-free ( $\nabla \cdot \mathbf{B} = 0$ ).

This makes it possible to understand why permanent magnets can be divided up any number of times, their strength decreasing but north and south pole remaining as they are. This is also the reason why neutron stars have an extremely strong magnetic field.

Just as the ionisation energy reflects the structural situation in the inside of a substance, the magnetisability depends on the structure of a substance, on the number and arrangement of the neutrons and their interaction with neighbouring atoms.

If energy is supplied to the N monopole - S monopole system, the exact opposite happens to what could be observed for the proton-electron pair: the S monopole cannot distance itself from the N monopole, the system falls back into its initial state instead, a neutron again forms from the two monopoles, and the magnetic state disappears.

This is the reason why the magnetism of a substance decreases when the substance is heated and disappears completely above a certain temperature, why cold bodies are easier to magnetise than warm ones, and why at low temperatures magnetic fields of any configuration can be frozen solid in superconductors.

Above all, this is the reason why all attempts to detect the monopoles have been doomed to fail so far, because the corresponding experiments always involved energy being supplied (electron microscopy, collision experiments), which causes an immediate recombination of the monopoles to form neutrons.

We thus observe a type of reversed photoelectric effect. With the photoelectric effect, energy is supplied to a sample and above a certain energy electrons which did not exist before escape.

With magnets, monopoles which previously existed disappear when energy is supplied.

The schematic below again explains the energy balance of the two connected events - the ionisation of the hydrogen atom and the decay of the neutron into monopoles:

Region	Process		
Real Imaginary Complex	H (2eS 1mS)	→	p <sup>+</sup> (2eS 1mS) + e <sup>-</sup> (2mS 1 eS)
	n (2mS 1eS)	→	N (2mS 1 eS) + S (2eS 1mS)
	Hn (3eS 3mS)	→	p <sup>+</sup> N (3eS 3mS) + e <sup>-</sup> S (3mS 3eS)
Energy balance	0	0	0

Fig. 4

It should be noted that the explanations above also explain why the wave function as the description of the state of a quantum must be rotated through 360° in order for it to change its sign (rotation of the real hydrogen quantum by 180° → imaginary neutron; rotation of the imaginary neutron by 180° → real hydrogen atom with opposite spin).

As has been shown, magnetic dipoles are not generated by electric currents, i.e. by moving electric charges. Neither are they the monopoles predicted by the GUTs (Grand Unification Theories), which should be a factor of around  $10^{17}$  heavier than a proton. They should therefore definitely be detectable in principle using the possibilities currently available to us. The discussion of the mutual formation of electric, magnetic and electromagnetic fields due to the motion of charges would far exceed the scope of this paper. The discussion is limited to the example of a moving electron to illustrate the fundamental mechanism on which Maxwell's equations are based:

- (real moving  $e^-$  = electric current = moving electric field)
  - (imaginary moving S monopole = magnetic flux = moving magnetic field)
  - (superposition of both fields to form the real electromagnetic field (there is no difference between real and imaginary regions for low-energy electromagnetic quantum fields)).
- Processes which are linked to the release or the consumption of electromagnetic quanta (with supply or release of energy) thus always consist of three simultaneously occurring processes.

### 5.5 Spectral Lines

Spectral lines are the result of processes in the inside of the atom and are important indicators of its structure. It will be shown below that, based on the alternative structure of the hydrogen atom, i.e. of a structure with no proton and no electron shell surrounding the atomic nucleus, the generation of spectral lines and the characteristics of the radiation emitted can be explained more completely than with the models which are currently valid.

Let us first return to Figure 1a and cut the structure in the xy-plane.

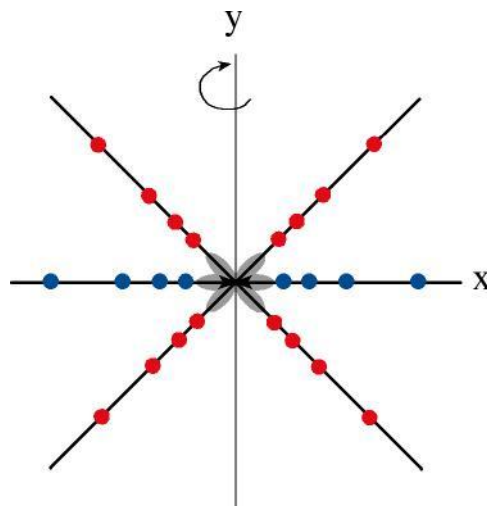

Fig. 5a

The two eS (red) and the mS (blue) become intersections which mark the separation of the spiral arms. The structure exhibits no distinguishing features. If the intersecting plane is turned in the direction of the xz-plane, the intersections of the eS shift continuously to the outside and the intersections of the mS towards the inside.

If the  $xz$ -plane is reached, a completely different picture emerges:

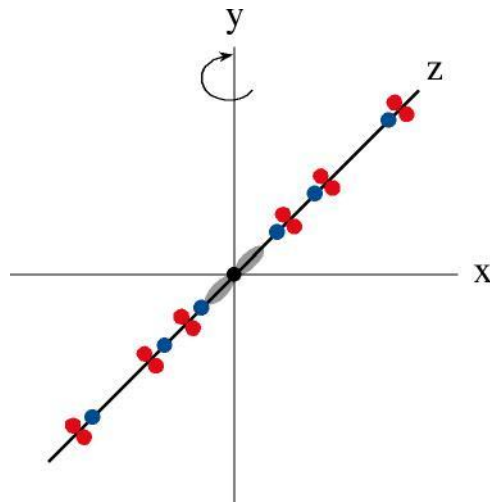

Fig. 5b

After each rotation of the two eS distinctive points appear in the  $zx$ -plane, where the right-handed and left-handed eS approach each other very closely. The distance of these points to the mass disc increases with a constant factor. As the distance of the two spiral arms from the centre increases, a point where the two spiral arms almost touch becomes an ever-increasing arm segment on which an ever-increasing number of points on opposite sides are located (shown as circles for simplification).



Fig. 5c



Since the structure rotates about the y-axis, the following image results:

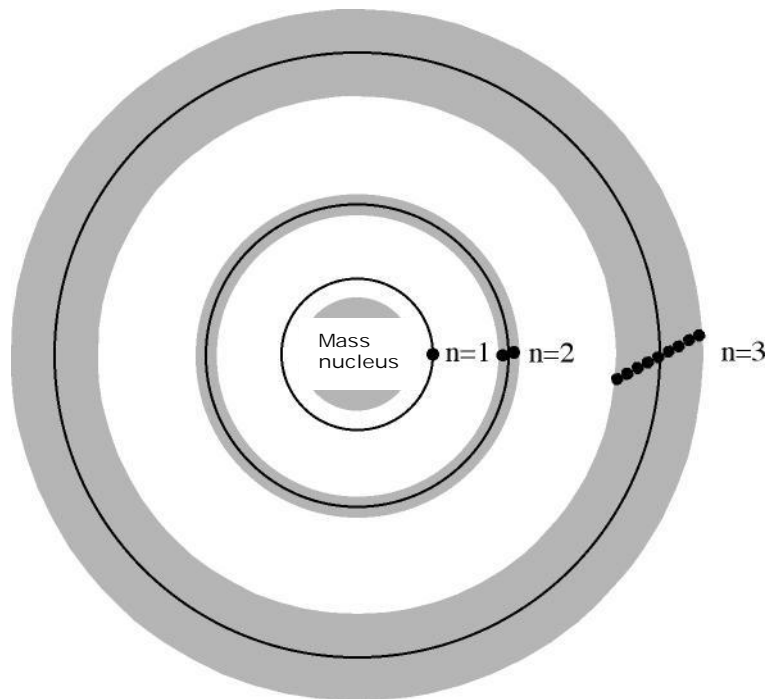

Fig. 5d

Bohr's model of the atom appears with its non-radiative orbits! The central, emphasized orbit corresponds to the point of closest approach of the two arms, i.e. a pair of quanta which are directly opposite each other. This orbit represents the principal energy level and the principal quantum number  $n$ . The grey area contains the other quantum pairs which are located on the two segments of the arc, whose energy level is specified by  $m$  and  $l$ . When the above image is expanded, the same number of energy levels as in Bohr's model ( $E_n = 2n^2$ ) can be presented. The number two here again represents spin up and spin down, i.e. the two quanta of the left-handed and right-handed eS which are located opposite each other.  $n^2$  represents the number of quanta which can be accommodated at level  $n$  on an arc segment. So if, for example, the two eS arms approach each other above the level of the mass disc for the third time ( $n = 3$ ), 9 quanta can be accommodated on an arc segment. Nine quantum pairs therefore form, which corresponds to 18 possible energy levels.

Now that we have shown that special points or special regions exist in the atom outside the mass region, we can now turn to the mechanism whereby spectral lines are generated. First we explain the characteristics of a region in which two quanta moving in opposite directions with the speed of light come close to each other. Since these quanta also consist of vortical fields and their spiral arms extend to infinity, the result is an interaction between the two quanta which weakens the structure of the atom at these points. These special points therefore prove to be points of weakness, predetermined breaking points, shearing points in the structure of the atom. (With composite atoms, rings of shearing points form which in turn again form various superposition states. This results in shearing points of the 1st, 2nd, ..... nth order, depending on the atomic number).

The further these points are from the centre (and thus also the more quantum pairs are arranged next to each other), the less energy is required to destroy the structure at these locations. To destroy here means to shear off the outer part of the spiral arm. If a photon, i.e. an energy packet of defined size, now impacts on such a point, and if its energy is large enough, one of the two spiral arms is sheared off, depending on the angle of impact. The sheared off part “wraps itself” with the speed of light around the point of its greatest curvature along the sheared off part of the spiral arm to form a spiral of its own, a photon. We observe this process as the emission of the photon. Its direction of motion thus correspond to the position of the spiral arm before the separation. The time the photon is emitted, its energy and the direction of its emission can therefore be accurately determined, in principle. Since two quanta are directly opposite each other in the shearing points, under normal conditions it is sometimes the left-handed spiral and sometimes the right-handed spiral which is sheared off, the two events having equal probability. Doublets form in the spectrum. If the energy of the incident photon is large enough to shear off the spirals at point P, they can also do this at all points whose distance from the centre is larger than that of P. For the hydrogen atom this results in series of spectral lines (Lyman, Balmer, Paschen series etc.).

Fields influence the excitation state of the atom (this can lead as far as field ionisation, as is well known) and hence the geometry of its structure. The effect is a further splitting up of the spectral lines (normal Zeeman effect in the magnetic field, Stark effect in the electric field). If the pulses of the incident photons are shortened more and more (ultra-short pulses) the spiral arms cannot form as quickly as they are sheared off (they “regrow” only  $3 \cdot 10^{-7}$  metres in a femtosecond). Only pieces of the spirals are now sheared off, the frequency/energy of the photons emitted is reduced.

We can see that no instantaneous events are required to explain the emission of photons. The Figure below illustrates this mechanism again, which is interpreted as an instantaneous transition between two energy states:

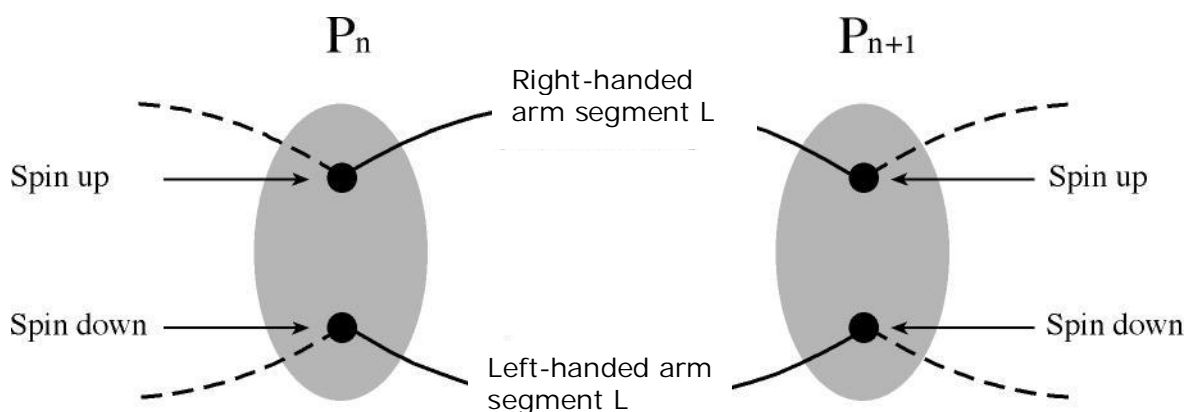

Fig. 6

We consider two arbitrary, neighbouring shearing points  $P_n$  and  $P_{n+1}$ , where  $P_n$  is closer to the axis of rotation of the eS. The arm segments L represent the energy  $\Delta E$ .

They can be assigned to both points, depending on the point of view: the arm cut off at  $P_n$  is longer by  $L_{P_n P_{n+1}}$  than the one cut off at  $P_{n+1}$ , or the arm cut off in  $P_{n+1}$  is shorter by  $L_{P_n P_{n+1}}$  than the one sheared off in  $P_n$ . Since quantum mechanics assigns  $\Delta E$ , i.e. the arm segment, to an electron, and there are only two states for the arm segment, i.e. sheared-off or not sheared-off, the transition of the electron between the two energy levels must happen instantaneously. Hence the spin up and spin down superposition state postulated, and thus the abandoning of determinism as well as the abandoning of locality by postulating instantaneous events, are a result of an approximation process, where non-massive energy states are assigned to a massive quantum object, the electron.

As the spiral arm of an eS is sheared off, action, i.e. the impinging of a photon, and reaction, i.e. the emission of a photon, occur immediately one after the other. This process can therefore not explain the spontaneous emission of photons, the apparently arbitrary time intervals between excitation of an atom and emission of the energy surplus. There must therefore be a further emission mechanism.

To this end we consider the interaction of the two eS and the mS. We choose the proton structure because it is clearer. The events in the hydrogen atoms are identical. The section of a part of the proton structure in the xy-plane clarifies the situation:

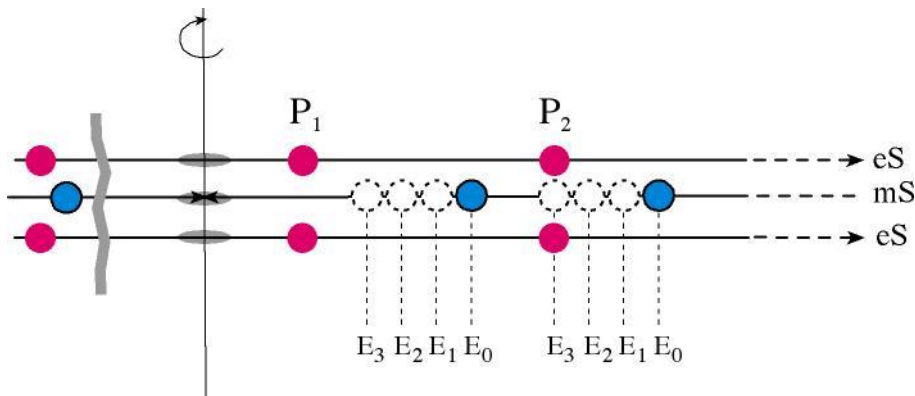

Fig. 7

The two eS are above or below the mS. The gradient of the eS is constant. The shearing points  $P_1$  and  $P_2$ , which are formed by two quanta which are opposite each other (red), are always in the same place. Since the mass of the down quark is greater than that of the up quark, the gradient of the mS is thus also greater than that of the eS even in the initial situation. When energy is supplied, it grows further, when energy is released, it returns to the initial situation. The quanta of the mS (blue) which are in the sectional plane thus move either to the left or the right depending on the excitation state of the proton. The gradient of the mS is therefore a function of  $\Delta E$  (excitation state minus ground state). If the energy  $E_1$  is supplied, the mS quanta move to the left. This process does not result in emissions of any kind. If  $E_2$  is supplied, the mS quanta move further to the left, the process not being observable from the outside either. When an amount of energy  $E_3$  is supplied, both eS arms are sheared off at the point  $P_2$  (when the gradient of the mS changes, only one shearing point is ever triggered), two quanta are emitted (bunching). If this process happens in a controlled way, we call it stimulated emission. Atoms are gradually “pumped up” with energy.

When defined energy states are reached, one additional quantum per atom is sufficient to cause a kind of discharge. Equally large pieces of the spiral arms are sheared off at all eS, i.e. photons of the same energy and the same orientation are emitted simultaneously (laser). The greater the energy supplied, the further the shearing point shifts towards the mass discs, the radiation emitted becomes harder. We usually know neither the exact excitation state of the atom nor the interfering radiation acting on the atom. If a defined energy portion (quantum) is now incident, the point in time when a shearing off point is reached is difficult to determine. The impression of spontaneous emission is created. If, however, the state of the atom and that of the incident photons were accurately known, the time of an emission could be precisely determined.

In practice this is not possible, however, because even a vacuum interacts with the atoms by virtue of its energy. As already explained, the vacuum energy here represents the totality of innumerable spiral arm segments of eS and mS which cross any arbitrary volume from all directions.

Using the examples above it has been shown how the atom reacts to the irradiation of energy, by emitting it immediately or storing it temporarily, by increasing the gradient of the mS and thus increasing the mass region. In addition to the irradiation of energy in the form of photons (this includes a rise in temperature of the surroundings) it is also possible to supply energy to the atom by increasing the energy of the atom itself. This happens when the atom is moved with a certain speed. Put a different way: the total momentum of the atom can be increased by quanta from the surroundings impacting, or by increasing its own speed. The higher the speed of the atom (the smaller  $\Delta v = c - v$ ), the more excitation energy is stored as mass. The relativistic increase in the rest mass of a massive particle is therefore not an apparent mass change from the point of view of an observer at rest, but a real change in mass depending on the relative speed of the massive particle compared to the speed of light.

The same mechanism is also the basis of the Doppler effect, where, depending on the direction of the relative velocity of transmitter and receiver, the mass point of electromagnetic quanta increases (blue shift) or decreases (red shift) so that the particle character of the quanta comes out more strongly or less strongly.

This interaction between the immediate release of energy absorbed or its temporary intermediate storage as additional mass is easiest to follow with electrons which are accelerated in a synchrotron. The gradient of the mS of the electrons increases as their angular velocity, the energy supplied is stored intermediately as mass. At the same time synchrotron radiation is emitted at every shearing point reached, the radiation becoming harder, the closer the shearing point comes to the axis of rotation. Since the shearing points are located closer and closer together towards the centre, more and more of the energy supplied is re-radiated, and an ever-decreasing portion can be stored intermediately as mass. More and more energy is therefore required to achieve a further increase in mass. The infinite increase in rest mass which is theoretically possible is thus not achievable in practice. Every synchrotron has a technical limit (orbital frequency of the electrons and diameter of the synchrotron) where an equilibrium between energy supplied and energy radiated forms. At constant angular velocity an arm segment of the mS oscillates about a shearing point and the frequency of the radiation emitted agrees exactly with the orbital frequency of the electrons.

A very fine, polarised X-ray with fixed direction of emission is produced. If the speed of the electrons is decreased, the process happens sort of backwards: the mass of the electrons decreases and X-ray bremsstrahlung is emitted.

The mechanisms described, which lead to the emission of radiation, make it clear that the hydrogen atom (just like the proton) consists of two regions, an active region which radiates energy, and a passive region which absorbs energy. The atom can thus be considered as a combination of a transmitter and a receiver.

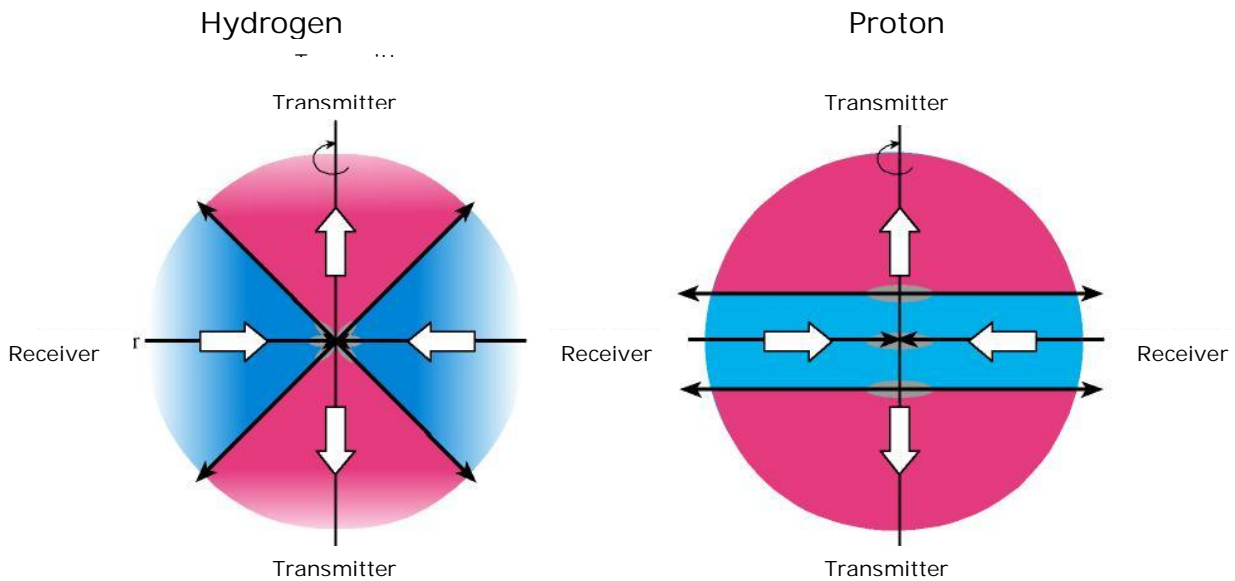

Fig. 8a

Fig. 8b

If atoms are now uniformly aligned by fields, or localised in bi-refractory crystals, for example, it is possible to directly address both regions by irradiation with suitable photons and to achieve a wide variety of effects. It is thus possible to generate photons of different frequency (signal photon and idler) or a broad spectrum of photons with desired frequencies (doubling of the incident frequency is also possible), extremely fine emission beam and specified direction of emission at the same time.

## 6. Symmetries

We speak of symmetries if characteristics of a system, i.e. in the broadest sense the natural laws, remain unchanged after certain transformations. But why is this so? What forces nature to symmetry? We have already provided the fundamental answer to this question: the universe is a complex structure whose total energy and the energy of each of its complex sub-structures is always zero (the universe is a structured nothing).

In concrete terms this means that symmetries are the expression of how nature strives to ensure a state of zero energy at any arbitrary point in space and at any arbitrary point in time (systems therefore do not strive for a state of lowest energy, but zero energy). This state of zero energy is realized everywhere in the complex universe. In our, the real part of the universe (as in the imaginary part), this high degree of symmetry only exists in the universe as a whole (and for the electromagnetic quanta which move with the speed of light). Our universe is electrically neutral overall, for example, i.e. there is always an equal number of positive and negative electric charges. And the sum of all positive and negative energies also equals zero. But there are local disturbances: in a structure, but also in whole regions, there can be more positive (interstellar hydrogen clouds) than negative energy (neutron stars) or vice versa. Charges can have different spatial and temporal distributions. There are therefore different degrees, different levels of symmetries. But nature in its entirety always remains symmetrical. There can therefore be no breaks in symmetry in the complex universe and we are well advised to analyse processes with so-called breaks in symmetry in detail.

### **6.1. Neutron Decay**

Let us take the symmetry between hydrogen atom and neutron, for example. At 0 Kelvin the two quanta are completely symmetrical, even their masses are equal. If the temperature is increased, i.e. energy is supplied, the excitation state of the neutron with its two mS increases twice as fast as that of the hydrogen atom with its one mS. The symmetry between the two quanta is increasingly lost. Decisive for the subsequent processes is not this symmetry between the two real quanta, however, but the symmetry with their imaginary companions. The symmetry of the real hydrogen atom with its imaginary neutron is thus increasingly destroyed by the continuous supply of energy, because in the imaginary region the energy flows remain constant. The system real hydrogen/imaginary neutron becomes more and more unstable. If a certain point is reached, the ionisation energy, the hydrogen atom decays into proton and electron. This recreates the symmetry on the complex level (total energy = zero). The process understood as a break in symmetry proves in reality to be a reaction of the system to the recreation of the symmetry. As has already been mentioned, although the two mS of a free neutron mean its excitation increases twice as fast as that of the hydrogen atom, the free neutron therefore becomes unstable earlier under the same conditions. With the decay into proton and electron the symmetry is also recreated here on the complex level. An antineutrino is formed with the excess energy. Here, too, an apparent break in symmetry is thus a process to recreate symmetry. Since the neutrons possess two mS, they are supplied with different amounts of energy by the quantum fluctuations/vacuum energy, whose energy densities are locally and temporally very different. Sometimes more energy flows in the one mS, sometimes more in the other. Occasionally there are simultaneous energy spikes in both mS. Under the same macroscopic conditions the neutrons therefore decay at different points in time (at room temperature 5 out of 10 neutrons in around 15 minutes). It is probable that radioactive decay in general is based on this mechanism. If free neutrons are bound in non-radioactive substances, the conditions change. In both mS, the same energy flows flow with a strength below the decay energy due to the bonds/fields/entanglements with the neighbouring atoms.

The neutrons remain stable. If the excitation energy reaches a substance-specific value by temperature increase, cooling or the effect of fields, however, the complex symmetry is recreated by changes to the structure of the substance (and possibly the structure of the neutrons and the hydrogen atoms as well).

This process, called phase transition, is therefore also not a break in symmetry, but the recreation of the symmetry on a complex level.

The transformations discussed can basically be summarised in three symmetry operations:

Operation	Structural Change	Result
Mirror the direction of rotation of quantum objects (QO) in real space	Spin up/R ↔ Spin down/L	Matter ↔ Matter
Mirror the quantum objects in real space	eS ↔ mS	Matter ↔ Anti-matter
Mirror the quantum objects in complex space	(+E) Electrical energy ↔ (-E) Magnetic energy	Real QO ↔ Imaginary QO

Fig. 9

## 6.2. Spin

The first symmetry level contains 180° rotations of quantum objects in three-dimensional space. The physics of the quanta is conserved in its entirety. The rotations are detected by means of the quantum spin. We remember that the arms of the spirals are formed from electromagnetic quanta which move on curved orbits. Each of these quanta thus has an angular momentum. The sum total of these momenta is the angular momentum of the spiral. Its magnitude is specified by the speed of the quanta and the parameters of the spirals. The spin is therefore the angular momentum of a logarithmic spiral formed from electromagnetic quanta and in this sense an intrinsic property of quantum objects. It characterises the rotational speed and the direction of the axis of rotation of quantum objects of the same type. If a quantum object consists of several spirals, the individual spins  $s = \pm 1/2 \hbar$  in steps of  $\pm 1/2$  add up to form the total spin:

- 3 spirals = fermions, leptons = spin (of one half)  $\pm 1/2$ ,
- 2 spirals = bosons (electromagnetic quanta, mesons) = (integer) spin 0, 1 (the spin 2 of the mesons  $f_2(1270)$  and  $a_2(1320)$  contradicts the meson structure assumed),
- 1 spiral = neutrino = spin  $\pm 1/2$ ,
- composite atoms = sum of the L+R spirals = spin).

Spin is therefore quantised and can be measured using the magnetic moment associated with it by the interaction with a magnetic field. Regardless of the direction chosen with respect to the measuring field, one always obtains the total spin and not only a partial value.

This means the same as that the axes of rotation of the quantum objects can only orientate themselves parallel (spin up) or anti-parallel (spin down) with respect to the field (whereas classical angular momentum can assume any angle with respect to a direction specified by the field and can thus assume any values).

The cause for the peculiarities of the quantum mechanical angular momentum compared to the mechanical angular momentum thus lies in the structure of the quanta and the interaction mechanism between the quantum objects and the (magnetic) field thus caused, which incidentally is identical to the generation mechanism of the Lorentz force. Even the quantum mechanical spin obeys the laws of classical physics.

## **6.2 Antimatter**

On the second symmetry level all elements of the structures are mirrored in three-dimensional space.  $mS$  turn into  $eS$  and vice versa. The measurable effect is a change in the sign of the charge. A positive charge turns into a negative charge and vice versa, something which is called charge symmetry. As we can see, the term “charge symmetry” does not describe the symmetry between matter and antimatter in its complexity, because it is not a change of charges, but the change in the direction of flow of the energy flows. This explains why even neutral particles form antimatter, although no charges are involved. On closer inspection, charged antimatter is nothing more than an enlarged or reduced copy of charged matter. The positron is a reduced proton, for example, and the antiproton an enlarged electron. It is as if nature were testing whether a 200-tonne truck reduced to the size of a 0.1-tonne car, and a 0.1-tonne car expanded to the size of a truck would be successful on the roads.

Matter and antimatter have the same physics, but if they come into contact with each other, this is virtually a head-on collision of the two structures overall as well as each individual quantum which forms the spiral arms. The momenta of each individual quantum pair and of the two structures overall add up to zero. Structures of equal size are downright blown to pieces. They annihilate and new structures form. If one of the particles is much larger than the other one, however, as is the case with the proton and the electron, which behave like matter and antimatter with respect to each other, the larger structure is conserved in the contact, albeit in a modified form, the energy of the smaller structure being incorporated into it.

## **6.3 Time Arrow**

On the third symmetry level the real structures are mirrored in complex space, so that their imaginary counterparts are formed at their “rear”. Conversely, imaginary structures are mirrored in our real world. As has already been explained, the nature of this symmetry lies in the equilibrium of positive and negative energy flows in the cosmos overall. On this level, the physics of structures changes while the complex total energy remains zero. The information connected with these energy flows is conserved, however.

According to Feynman-Stückelberg the Dirac equation, which assigns a corresponding state with negative energy to each quantum state with positive energy, describes the dynamics of an electron with positive energy as well as that of its antiparticle,



the positron, with negative energy. The state of negative energy is explained here with a positron which moves backwards in time, mathematically speaking. Consequently, CPT symmetry for this purpose means that each state with negative energy and negative time arrow can be assigned to every state of positive energy and positive time arrow.

Thus if all observables are mirrored, a quantum object with positive energy turns into an object with negative energy and vice versa. Since in the current view of things neither particles with negative energy nor a reversal in time is observed, the process with negative energy is therefore assigned to a hypothetical anti-universe.

The problem of negative energy remains unsolved, it is simply moved from our real world into a hypothetical anti-world. As has been shown, positive and negative energies are physical phenomena of our real world.

With the electric logarithmic spirals, energy flows from the imaginary universe into our real one. The past of this energy is in the imaginary world, its present and future are in the real world. The time arrow points towards our real world. The energy is positive. With the magnetic spirals the energy flows out of our real world into the imaginary universe. The past and present of this energy are in our world, the future in the imaginary one. The time arrow points in the opposite direction away from our universe. The energy is negative. Hence, our real world (and the imaginary universe) contains quantum objects with overall positive energy and thus positive time arrow, and quantum objects with overall negative energy and negative time arrow. When we solve the question as to the direction of net energy flow in our universe we will know in which part of the complex universe we are. The T-symmetry is thus much more far reaching and is not exhausted with a formal, mathematical reversal of time.

## 7. Alternative Standard Model

In the Appendix the structures discussed and the mechanisms of their transformations are summarised in an overview of the fundamental stable quanta. The quantum objects are grouped together according to their structure, i.e. according to the number of spirals/vortical fields which form them. In the first row are the quanta from which the quanta below are formed by symmetry operations.

The largest group with three spirals is derived from the hydrogen atom.

Stable structures are not known in the group of two crossed or parallel spirals.

The third group is formed by massive quantum objects with one spiral. It contains the neutrinos and the antineutrinos. If the neutrino is an  $mS_L$ , then the antineutrino must be an  $eS_L$ . (Left-handed antineutrino and right-handed neutrino would then be  $eS$  and thus "sterile". They would only be subject to gravitation). Neutrinos thus represent the two fundamental structures which make up all massive matter. Neutrinos and antineutrinos can thus be understood as free quarks, and the question remains as to whether it would be possible to describe all matter as resonance states of neutrinos and antineutrinos. This would possibly offer a completely new approach to be able to explain the universe without Big Bang and without a break in symmetry between matter and antimatter.

Objects without rest mass, i.e. the electromagnetic quanta, have a special status. They represent the complex reality with their crossed spirals. Since their basic structure does not change in any symmetry operation, they are the only quantum objects which can be assigned to both the real world and the imaginary world.

If the gradient  $k$  of  $mS$  is decreased by  $\Delta k$  by supplying energy, the overview expands downwards. The 2nd and 3rd particle generations form as unstable resonance states and possibly even further, higher energy levels. All mesons, which consist of two spirals (parallel arrangement of the spirals = charged mesons), must be assigned here. The expansion of the model in this direction corresponds to the reductionist method of physics, the expectation that our knowledge will increase if we use higher and higher energies to split baryonic matter into smaller and smaller structures and fuse them into new quantum objects.

When the overview is expanded towards the left, the periodic system of the elements, then larger and larger masses and finally black holes follow. At the end there is probably a central black hole, which determines the speed of light and the fundamental laws of our universe.

If the overview is expanded towards the right, electromagnetic quanta with lower and lower energy follow. When nothing structures to zero-dimensional complex energy points, the beginning of the universe has been reached. Time and space start to form and develop the properties they have today in a continuous process.

## 8. Conclusions

The physics of matter can be explained without contradictions on the basis of the model presented. The contradictions between the current quantum mechanical description of nature and classical physics and GTR are removed.

The uncertainty relation is put into perspective and, in principle, the state of quantum objects can be determined exactly. Quantum mechanics therefore leaves the statistical level. It becomes deterministic and local like classical physics and the theory of relativity. The causality law regains its full validity. The fundamental features of quantum theory remain correct, but it also becomes complete.

Nature proves to be an extraordinarily finely structured, emergent (self-organising) fractal system of only two fundamental elements, the STQs as energy carriers and the logarithmic spirals (vortical fields) as the mode of energy transport. Temporal and spatial changes in space-time density create a fundamental force which is evident in the form of the familiar interactions in the different ranges of scale.

This creates the prerequisites for the unification of quantum theory, classical physics and the theory of relativity. The description of all natural phenomena with the aid of only one fundamental structure and only one fundamental force moves to within our grasp.

It is obvious that the model of the structure of matter presented has fundamental effects on the overall current worldview. The universe turns out to be a complex structure where real and imaginary worlds which mirror each other form an inseparable physical unit. The two parts and each of their structures are phenomena which form as the result of flows of positive and negative energy with different strengths, the total energy always remaining zero. Our world is only the real part of this complex universe. The constancy of the quantum objects and the large times scales of the processes occurring in the macro-world turn out to be an illusion. The universe as a whole and each of its complex structures cease to exist at every point in time and form anew at every point in time. A world whose matter is supposed to have formed in one act, a big bang, is not compatible with a universe such as this which is based on continuous processes. Cosmology also is on the verge of a paradigm shift.

## Alternative Standard Model of Particle Physics

