

LHC signals between 121-130 GeV interpreted with non Standard Model Quantum-FFF theory.

Leo Vuyk,
Architect,
Rotterdam, the Netherlands.
LeoVuyk@Gmail.com

Abstract,

In Quantum Function Follows Form theory, (Q-FFF) the Higgs particle is interpreted as a massless transformer particle able to create the universe by transforming its shape after real mechanical collision and able to merge with other shaped particles into composite geometrical knots called Quarks and some Leptons (Muons and Tauons).

Singular particles are; the two Leptons: the Electron and Positron, different shaped Photons, Gluons and neutrinos all originated out of one single transformed Higgs.

As a result, Q-FFF theory leads to a NON Standard Model of elementary particles, also described in this paper.

As a consequence the recent Large Hadron Collider (LHC) results, showing special values between 121-130 GeV for the predicted signal of the massive Standard Model (SM) Higgs, should be interpreted as the result of one or more different composite particle decay- and collision processes and not as the result of Higgs decay.

In this paper I present some possible transformations after the collision of (Non- SM) Proton particles interpreted as Quark- Gluon cloud collisions, into the observed production and decay results such as, gg into Di-Photons, ZZ into 4 Lepton or WW into LvLv .

Introduction,

According to Quantum-FFF Theory, it is assumed that the vacuum is seeded with massive numbers of massless Higgs particles, all energetic oscillating inside and along a chiral tetrahedral based vacuum lattice system and as such, the origin and bearer of all energy in the universe. (reference: 16: Construction Principles for Chiral "atoms of Spacetime Geometry") If by a local energy excess, two Higgs particles collide with enough energy, it is assumed that at first an Electron and Positron emerges by the mutual transformation of the two Higgs particles.

Due to the propeller shape of the Fermions, these Fermions start to spin by a constant collision and scattering process with the Higgs vacuum, changing Higgs particles continuously into different forms of Photon/Gluons and Gravitons

As a result, I found, that many "elementary" particles should not be elementary, but compound constructions or KNOTS made up by transformed Higgs particles.

Even the Muon and Tau Lepton should be compound particles having the same shape as one of the different coloured "naked" Down- respectively Charm Quarks. (figure: 6)

Thus, Muon- and Tau particles are supposed to be "naked" Quarks not protected by a Gluon cloud, but directly bombarded and driven by the Higgs vacuum lattice.

As a consequence of this Non Standard Model I will describe some examples of possible collision and decay processes which could be responsible for the recent LHC findings between 121 and 130 GeV.

In Q-FFF theory the Non Standard Model (Non SM) Higgs is presented as a massless complex 3-D ring (torus) shape divided in four equal pieces which are connected by three disc-like hinges, which can rotate into only four 90 degree-positions with the possible coding: L,R,O and U.

The result is that each singular particle only can be coded by three of these four letters, e.g. as ORO, OLO, UOU etc. (figure 1)

I will start with the description of how we could interpret the recent LHC findings however, I will use terms and codings of the so called alternative Standard Model described later in this letter starting with figure 1.

Quantum-FFF theory based description for the recent LHC results for Di-Photon, ZZ and WW decay signals.

1: Non SM Transformation of Gluons into Photons: $gg \rightarrow \gamma\gamma$

The most important discovery channel for a SM Higgs boson at the LHC, is the Di-Photon signal original coded $gg \rightarrow \text{Higgs} \rightarrow \gamma\gamma$

However in Q-FFF theory the two Gluons are able to transform directly into two Photons, without the production of a SM Higgs, but by the mechanical aid of four massless oscillating Higgs particles out of the vacuum.

The most obvious Gluons which are assumed to be able to such a direct transformation are the Gluons coded: LOL or ROR, since they have the form and symmetry needed for external dual in tandem oscillating (ring shaped) Higgs particles to transform both “arms” of one Gluon LOL or ROR at the same time and create a “general Photon” used for the range of visible light to gamma rays, coded UOU .

Thus we need 4x Higgs bosons not for decay product, but for internal particle change by rotation.

(for particle coding see figure: 1)

2: The ZZ production by Quark collision and decay into 4x Leptons.

In Q-FFF theory, the Z particle, is a compound particle (knot)of the Electron and Positron coded (OLO+ORO) (See figure 10)

To produce a ZZ combination we need the ingredients (Electron ORO and Positron OLO) of 2x d and 2x u Quarks.

(For Quark generations see figure: 4 and 6)

As a consequence, the decay of the ZZ (2x OLO+2xORO) into 4 Leptons is as follows:

A: ZZ decay simply by falling apart into 2x Electrons arbitrarily coded 2x(ORO) and 2x Positrons 2x(OLO).

Or:

B: ZZ decay into Muons. The Electrons and Positrons released by the ZZ, seem to be also able to attract Gluons out of the Quark Gluon plasma and form Muons.

1x OLO is supposed to transform by addition of two Gluons (ROR) into 1x (OLO+2xROR)= Muon+) see figure 6.

1x ORO is supposed to transform by addition of two Gluons (LOL) into 1x (ORO+2xLOL= Muon-) see figure 6.

C: ZZ decay into 4xTauons is not possible (and not observed in the LHC) only by the ingredients of the two ZZ, since each Tau particle needs 2x Electrons or 2xPositrons as a composite base.

Consequently, according to Q-FFF theory, there is only room to decay ZZ into 2x Tau Leptons.

3 The WW production by Quark collision and decay into LvLv.

In Q-FFF theory, the W particle is a compound particle of (2xOLO+1xORO=W+) or (2xORO+1xOLO=W-) (See figure 10).

However, there is something strange here:

To produce a set of W+W+ particles we need the TOTAL Electron and Positron ingredients of only TWO colliding Protons.

However, to produce a set of W-W+ particles we need ingredients of THREE colliding Protons or at least an extra Quark, since we need 3x colliding d- Quarks (ORO+2xLOL) and 3x u Quarks (OLO+ROR) out of Proton nuclei. Inside two protons we count 2x duu. As a consequence, we need at least three protons because for the production of W+W- we are short of one d quark, which we have to find somewhere else in a third proton. Thus we count in total: 3xOLO, 3xORO; all the ingredients needed for the W+W- combination.

However we also count 3x ROR and 6x LOL Gluons/Photons left behind in the Gluon sea, or partly needed for the Muon production we need only. (2x ROR + 2x LOL)

The decay the W+W- into 2x Leptons and 2x neutrinos (LvLv) has also some other neutrino problems. (see Matt Strassler: 12-11-2011, Seeking and Studying the Standard Model Higgs Particle) <http://profmattstrassler.com/>

According to Q-FFF theory this could be solved, because we get not 2x neutrinos but 4x neutrinos!

A: For W+W- decay into Electron Positron pairs we get not LvLv but LvvLv!):

In Q-FFF theory, a Positron OLO and Electron ORO can be transformed by dual Higgs oscillations into respectively LLL respectively RRR.

Consequently:

W+W- (3x OLO and 3x ORO=total) can be transferred into 1x OLO Positron and 1x ORO Electron plus 2x LLL and 2x RRR Muonic neutrinos. **(We count 4xNeutrinos!)**

B: For W+W- decay into Muon + Muon - pairs we also get LvvLv

In Q-FFF theory, a Positron OLO and Electron ORO can be transformed by dual Higgs oscillations into respectively LLL respectively RRR.

W+W- (3xOLOand 3x ORO) can also be transferred into 1x OLO Positron and 1x ORO Electron added with 2x LLL and 2x RRR Muonic neutrinos.

Thus we count again 4x Neutrinos!

However, to produce Muons we need additional Gluons (2x ROR + 2x LOL) out of the Gluon sea, which merge with the Electron and Positron into Muonic knots.

As a result we get:

1x OLO+2xROR (Muon +) plus 2x LLL Muonic Neutrinos and

1x ORO+2xLOL (Muon -) plus 2x RRR Anti Muonic Neutrinos (figure 1)

In Q-FFF theory, a Positron OLO and Electron ORO can be transformed by dual Higgs oscillations into respectively LLL or RRR.

ALTERNATIVE STANDARD MODEL

of elementary (single) particles with click-on potentials to form compound Quarks- and Leptons.

Explanation of the codes:
 U= Up rotation (180 degrees)
 O= Unchanged circle.
 L= Left rotation (90 degrees)
 R= Right rotation (90 degrees)

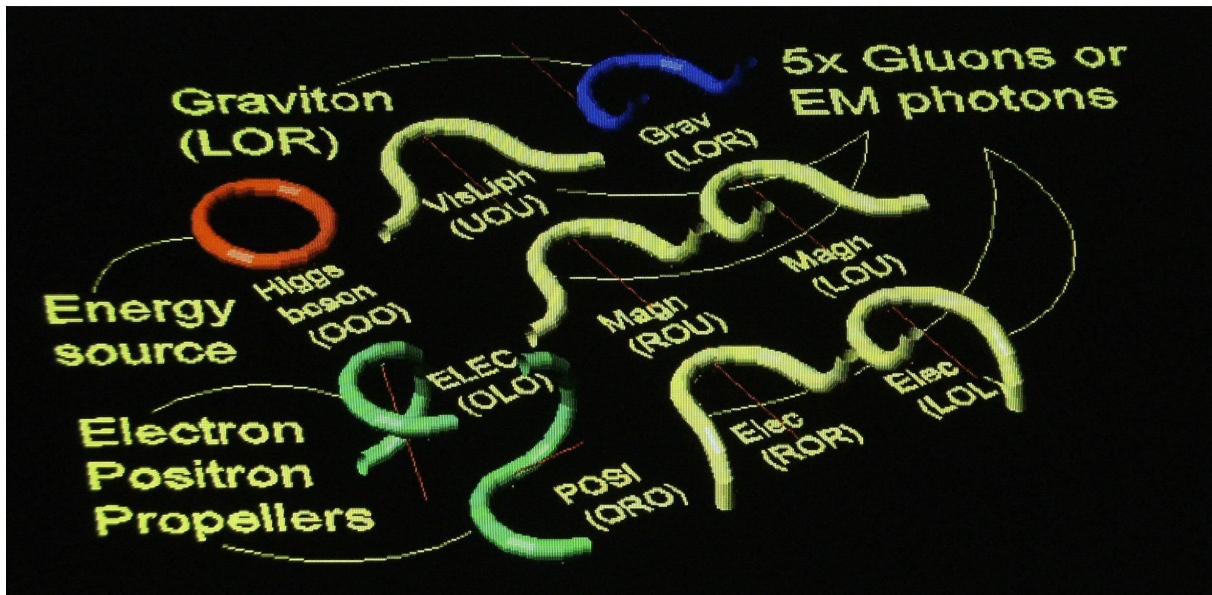
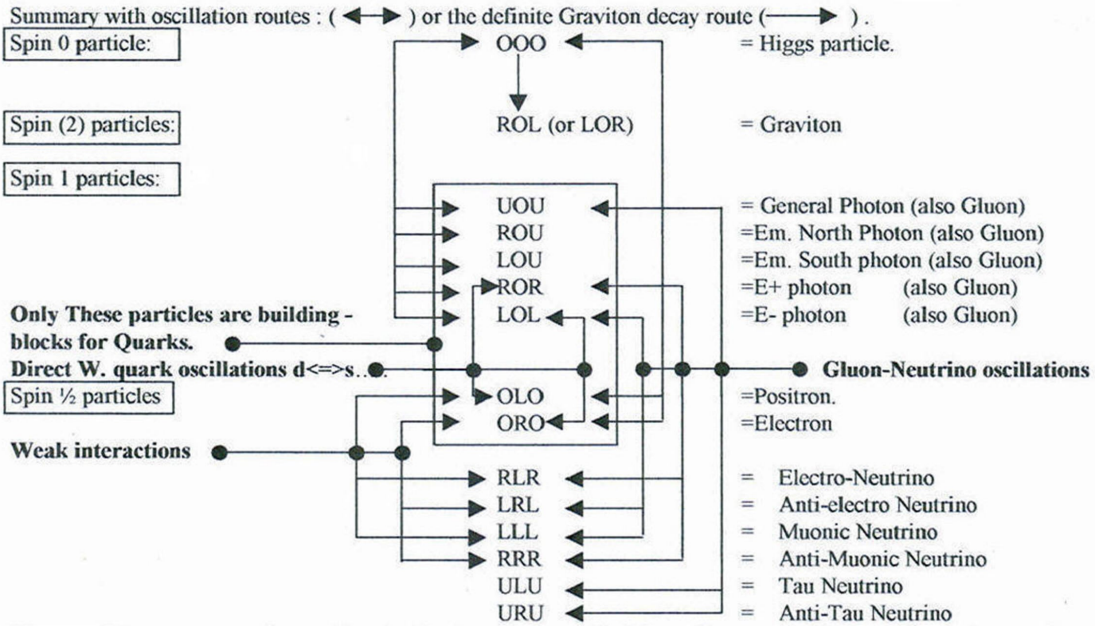
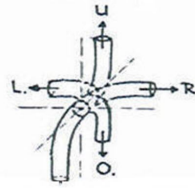

Figure 1, 3D image of Basic Singular Particles;
 ONE Higgs boson (OOO), TWO basic single mirror symmetrical Fermions: the Electron and Positron (OLO and ORO), ONE Graviton (LOR), TWO sets of mirror symmetrical monopole Gluons/Photons (ROU-LOU, ROR-LOL) One symmetrical Gluon Photon (UOU).

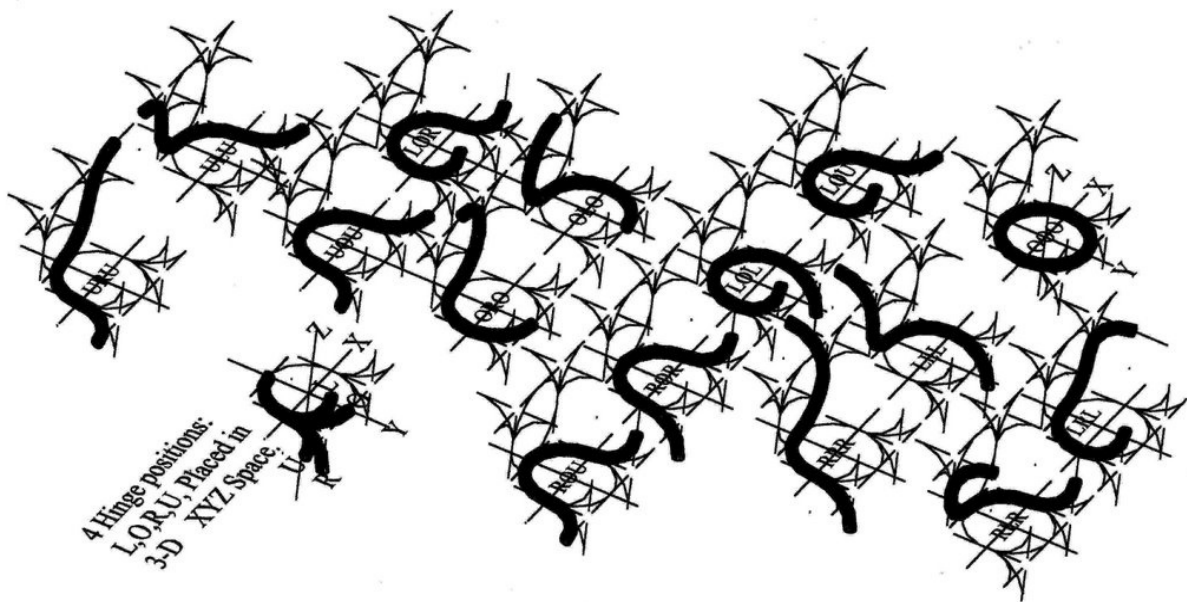

Figure 2, 3D image of all Singular particles including 3 sets of mirror symmetrical Neutrinos: RLR-LRL, RRR-LLL, URU-ULU.



Figure 3, 3D image of the Leptons: Electron, Positron, (singular ORO or OLO) , Muons (naked d quarks ORO+2xLOL or OLO+2xROR) and Tauon particles (naked Charm Quarks 2xORO+2xLOL or 2xOLO+2xROR)



Figure 4, 3D-Image of all 36 Quarks: UP-DOWN-STRANGE-CHARM-BOTTOM-TOP.

Geometry of the GOD particle based on four ELBOW MACARONI shaped arms connected with three hinges. These hinges are only able to rotate in steps of 90 degree rotation, coded with: O, L, R, and U relative rotations.

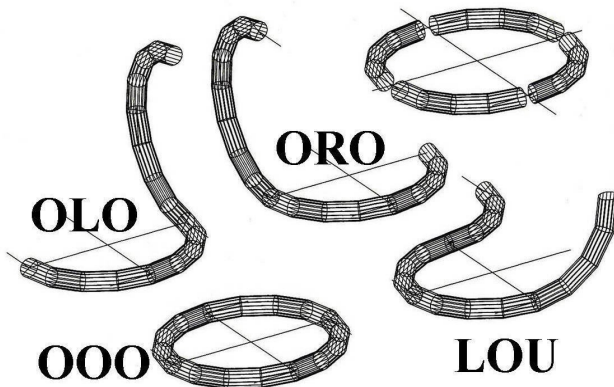

Figure 5.

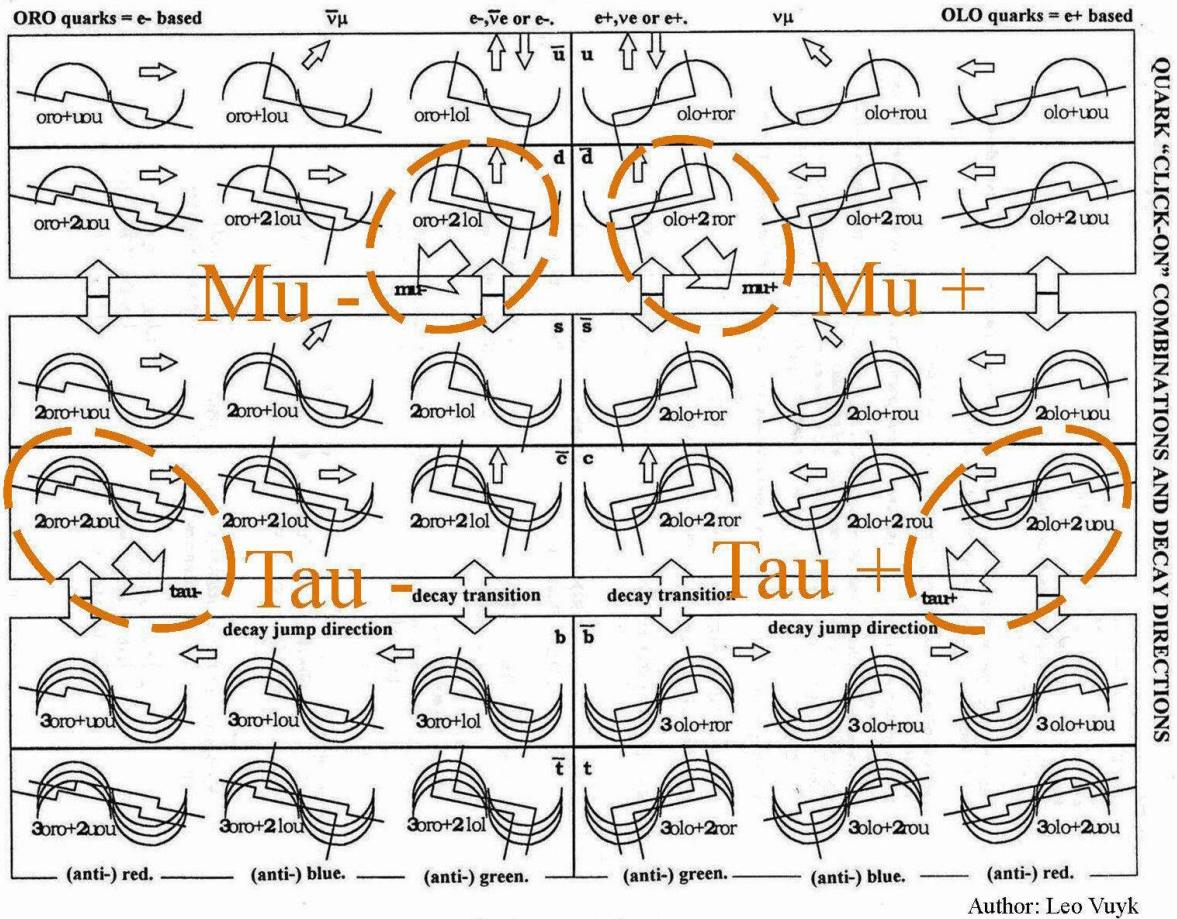

Figure 6, Simplified 2D image of Leptons and Quarks including indications for Decay routes indicated by arrows.

The Weak force, how change a d-quark (ORO+LLL+LRL) into an u-quark (OLO+ROR) in the case of Neutron-- Proton decay.

semi-leptonic processes

$$n \Rightarrow p + e^- + \bar{\nu}_e$$

$$ddu \Rightarrow duu + e^- + \bar{\nu}_e$$

The principle interaction is :

$$d \Rightarrow u + e^- + \bar{\nu}_e$$

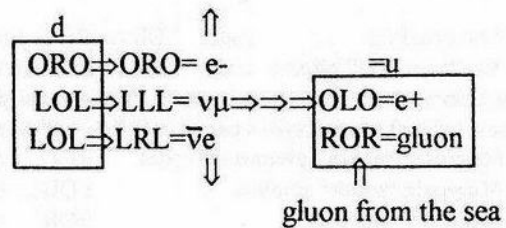

Figure 7, The WEAK force in action by a complex exchange of particles and without a clear sign of the Weak particle. Conclusion there is no need for a massive Weak particle in this system. The massless Higgs particle, seems to do the job properly by transformation of two compound Gluon particles (LOL) attached to the Electron (ORO): (LOL into LLL) and (LOL into LRL) . In succession, the (LLL) particle is changed into (OLO) a Positron, able to combine with a free Gluon (ROR) out of the SEA of Gluon plasma.

THE DECAY OF QUARKS AND LEPTONS

According to my model: elementary particles have a **sub-quantum structure**, caused by the postulate that a kind of Higgs particle is the **basic elementary particle**. (see the relation with the model page: 4)

Two Higgs particles can change form by collision into an electron and positron pair.(ORO+OLO)

Each Higgs particle can change form by collision with a quark or lepton into one of the **6 different possible types of photons:**

- 1: **The graviton** code: LOR (or ROL) can not "click-on" to e+ or e- particles to form quarks.
 - 2: **The "general" photon** code UOU. can "click-on" to e+ or e- particles, to form quarks for all "red, anti-red" (the colors are my own choice) quarks. The general photon has no quark confinement function, so is not a "real" gluon. **The 4 (gluon) photon types can also "click-on" to e+ or e- they are:**
 - 3: **Magnetic "north" photon** (in code) ROU. combining for all "positive/blue, anti-blue" quarks.
 - 4: **Magnetic "south" photon** LOU. combining for all "negative/blue, anti-blue" quarks
 - 5: **Electric + photon** ROR. combining for all "positive/green, anti-green" quarks.
 - 6: **Electric - photon** LOL. combining for all "negative/green, anti-green" quarks.
- Quarks** are "click-on" combinations of e- and e+ with 5 different types of photons: 4 gluon types and 1 general type. (so: quarks are not elementary)

Together with 1,2 or 3 electrons, 3 photon types can "click on" and combine into different **negative charged quarks**.

The **electron**: ORO can combine with LOL, LOU (gluons) and UOU (general photon)

Together with 1,2 or 3 positrons, 3 photon types can "click on" and combine into different **positive charged quarks**.

The **positron**: OLO can combine with ROR, ROU (gluons) and UOU (general photon)

Higgs boson (in code) OOO

The H-bosons is responsible for:

A: all .photon/gluon production, as continuous collision product with all masscarrying particles.

(OOO+lepton/quark= photon/gluon+lepton/quark

B: spontaneous pair production (OOO+OOO=ORO+ OLO (e- and e+)),

Z	=ORO+OLO	Z-boson (electron + positron can "click" together, without annihilating each other)
Wo, W+ and W-		don't exist as particles.
e-	=ORO	electron.
e+	=OLO	positron.
ve	=RLR	electr. Neutrino.
$\bar{\nu}_e$	=LRL	anti-electr. Neutrino.
ν_μ	=LLL	muonic neutrino.
$\bar{\nu}_\mu$	=RRR	anti- muonic neutrino.
ν_τ	=ULU	tau neutrino
$\bar{\nu}_\tau$	=URU	anti- tau neutrino

For quark click-on combinations: see page 25 (opn).

Quark "up-grading" due to subjoining of extra ORO's (or OLO's) (energy addition) and extra gluons, joining from the "sea" of gluons (energy addition)

e- → \bar{u} → d → s → \bar{c} → b → \bar{t}

→ ORO → 1 ORO → 1 ORO → 2 ORO → 2 ORO → 3 ORO → 3 ORO.
 1gluon → 2 gluon → 1 gluon → 2 gluon → 1 gluon → 2 gluon.

e+ → u → \bar{d} → \bar{s} → c → \bar{b} → t

→ OLO → 1 OLO → 1 OLO → 2 OLO → 2 OLO → 3 OLO → 3 OLO.
 1gluon → 2 gluon → 1 gluon → 2 gluon → 1 gluon → 2 gluon.

The **muon** is equivalent with the naked (anti) green d(own)-quark

The **tau** is equivalent with the naked (anti) red b(ottom)-quark

The differences between:

e- and \bar{u} , is one gluon,
 \bar{u} and d, is one gluon,
d and s, is one gluon changed form into an e-
s and \bar{c} , is one gluon,
 \bar{c} and b, is one gluon changed form into an e-
b and \bar{t} , is one gluon .

Quark “down-grading or decay” is going down the energy ladder, “spitting out” e-, e+’s and gluons in their original form (unchanged) or changed into neutrino’s.

Quark stability is originated by the sub-quantum structure of the quark
If the structure has

1: an A-symmetric form (such as the (anti-)blue u-,s- and b-quarks), the ability to spin, and the stability is minor to those with a symmetric form.

2: more components, this will lead to:decrease of stability and mass increase due to more protuberances (more vulnerability for Higgs impulses) resp. more production of gravitons)

Lifetimes and decay routes of quarks should be dependant of these rules, but we see interesting changes:

The preferred (anti-) red-blue- green sequences of the decay ladders are changing between the charm and the bottom quarks.

The differences in the sequences of charges related to the mass ladder is not clear. Further investigation is needed.

Systematic summary of basic quark decay modes.

e- and e+ \Rightarrow UOU = general photon (annihilation)

$\bar{u} \Rightarrow e^-, \bar{\nu}_e$	$\left \begin{array}{l} \text{ORO} \Rightarrow \text{ORO} = e^- \\ \text{LOL} \Rightarrow \text{LRL} = \bar{\nu}_e \end{array} \right.$	$u \Rightarrow e^+, \nu_e$	$\left \begin{array}{l} \text{OLO} \Rightarrow \text{OLO} = e^+ \\ \text{ROR} \Rightarrow \text{RLR} = \nu_e \end{array} \right.$
$\bar{u} \Rightarrow e^-$	$\left \begin{array}{l} \text{ORO} \Rightarrow \text{ORO} = e^- \\ \text{LOL} \Rightarrow \text{gluon sea} \end{array} \right.$	$u \Rightarrow e^+$	$\left \begin{array}{l} \text{OLO} \Rightarrow \text{OLO} = e^+ \\ \text{ROR} \Rightarrow \text{gluon sea} \end{array} \right.$
$\bar{u} \Rightarrow \bar{\nu}_\mu$	$\left \begin{array}{l} \text{ORO} \Rightarrow \text{RRR} = \bar{\nu}_\mu \\ \text{LOL} \Rightarrow \text{gluon sea} \end{array} \right.$	$u \Rightarrow \nu_\mu$	$\left \begin{array}{l} \text{OLO} \Rightarrow \text{LLL} = \nu_\mu \\ \text{ROR} \Rightarrow \text{gluon sea} \end{array} \right.$

(d (anti-)green is also: μ)

$d \Rightarrow e^-, \bar{\nu}_e, \nu_\mu$	$\left \begin{array}{l} \text{ORO} \Rightarrow \text{ORO} = e^- \\ \text{LOL} \Rightarrow \text{LRL} = \bar{\nu}_e \\ \text{LOL} \Rightarrow \text{LLL} = \nu_\mu \end{array} \right.$	$\bar{d} \Rightarrow e^+, \nu_e, \bar{\nu}_\mu$	$\left \begin{array}{l} \text{OLO} \Rightarrow \text{OLO} = e^+ \\ \text{ROR} \Rightarrow \text{RLR} = \nu_e \\ \text{ROR} \Rightarrow \text{RRR} = \bar{\nu}_\mu \end{array} \right.$
---	---	---	---

$\pi^- \Rightarrow \mu^-, \nu_\mu$	$d = \mu^-$	$\pi^+ \Rightarrow \mu^+, \nu_\mu$	$\bar{d} = \mu^+$
$d\bar{u}$	$\bar{u} \left \begin{array}{l} \text{ORO} \Rightarrow \text{RRR} = \bar{\nu}_\mu \\ \text{LOL} \Rightarrow \text{gluon sea} \end{array} \right.$	du	$u \left \begin{array}{l} \text{OLO} \Rightarrow \text{LLL} = \nu_\mu \\ \text{ROR} \Rightarrow \text{gluon sea} \end{array} \right.$

$K^- \Rightarrow \mu^-, \nu_\mu$	$\bar{u} = \left \begin{array}{l} \text{ORO} \Rightarrow \text{RRR} = \bar{\nu}_\mu \\ \text{LOL} \Rightarrow \text{gluon sea} \end{array} \right.$	$K^+ \Rightarrow \mu^+, \nu_\mu$	$u = \left \begin{array}{l} \text{OLO} \Rightarrow \text{LLL} = \nu_\mu \\ \text{ROR} \Rightarrow \text{gluon sea} \end{array} \right.$
$s\bar{u}$		$\bar{s}u$	

$s = \left \begin{array}{l} \text{ORO} \Rightarrow \text{ORO} \\ \text{ORO} \Rightarrow \text{LOL} \\ \text{LOL} \Rightarrow \text{LOL} \end{array} \right. = \mu^-$	$\bar{s} = \left \begin{array}{l} \text{OLO} \Rightarrow \text{OLO} \\ \text{OLO} \Rightarrow \text{ROR} \\ \text{ROR} \Rightarrow \text{ROR} \end{array} \right. = \mu^+$
---	---

Three different kinds of Weak interactions.

Hydronic decays:

$$\Lambda_0 \Rightarrow \pi^- + p$$

$$uds \Rightarrow udd \Rightarrow \bar{u}d + uud$$

The principle interaction is:

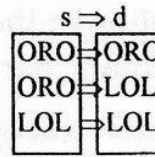

$s \Rightarrow d$ and pair production (addition) of u and \bar{u} from the Higgs and gluon "sea"

semi-leptonic processes

$$n \Rightarrow p + e^- + \bar{\nu}_e$$

$$ddu \Rightarrow duu + e^- + \bar{\nu}_e$$

The principle interaction is :

$$d \Rightarrow u + e^- + \bar{\nu}_e$$

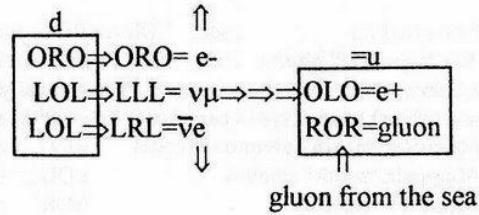

leptonic processes

$$\mu^- \Rightarrow e^- + \bar{\nu}_e + \nu_\mu$$

$$d \Rightarrow e^- + \bar{\nu}_e + \nu_\mu$$

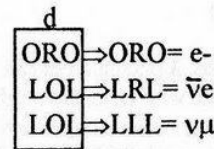

Some electromagnetic decays.

$$\pi_0 \Rightarrow \gamma + \gamma \quad \text{ORO+OLO anihilation} \Rightarrow 1x \gamma$$

$$u\bar{u} \Rightarrow 2 \gamma$$

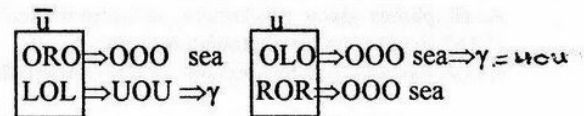

$$\eta_0 \Rightarrow 2\gamma \quad \text{ORO+OLO anihilation} \Rightarrow 1x \gamma$$

only: $\bar{d}d$ decays $\Rightarrow 2\gamma$
so first: $\bar{s}s \Rightarrow \bar{d}d$.

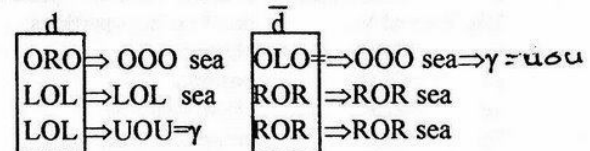

$$\Sigma_0 \Rightarrow \Lambda_0 + \gamma$$

$$uds \Rightarrow sdu + \gamma \quad d \Rightarrow \bar{u} \Rightarrow d$$

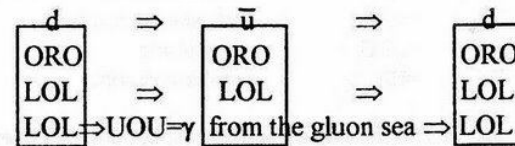

Some strong interactions.

$$\Lambda^{++} \Rightarrow p + \pi^+ : uuu \Rightarrow duu + u\bar{d}$$

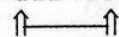

$d\bar{d}$ pair production from the Higgs and gluon sea

$$\Delta_0 \Rightarrow p + \pi^- : ddu \Rightarrow duu + d\bar{u}$$



$u\bar{u}$ pair production from the Higgs and gluon sea

$$\Delta_0 \Rightarrow n + \pi_0 : ddu \Rightarrow ddu + u\bar{u}$$



$u\bar{u}$ pair production from the Higgs and gluon sea

The double spin of Fermions.

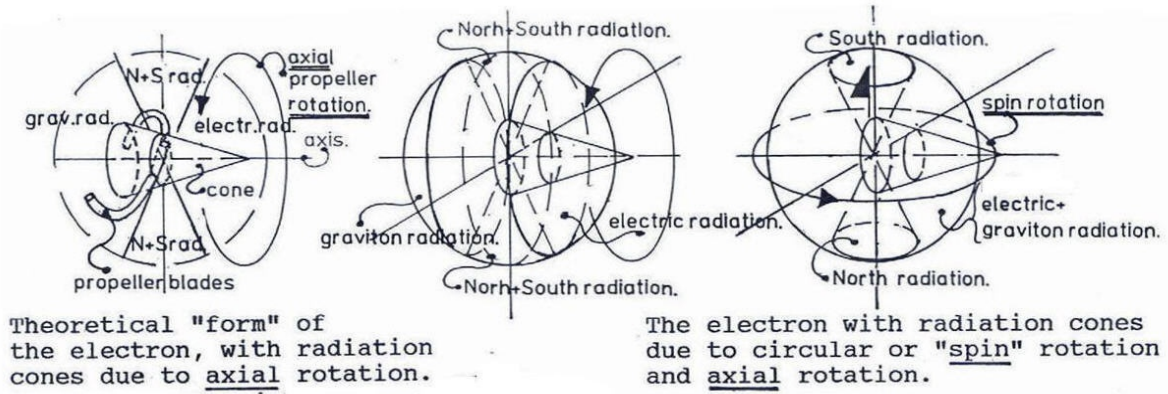

The "Eigen energy" distribution around the spinning Fermion propeller, is supposed to come in cone form. The Fermion spin and radiation is the product of a scattering process with oscillating Higgs vacuum particles. As a result, the Fermion has a double spin around two polar axes. This is supposed to be the origin of a dipole Magnetic field with North and South monopole photon radiation and the circular distribution of graviton and electric radiation. In addition it must be stated that all Fermions are entangled with their object /subject particle far away.

Figure 8, double spin of Fermion and Quark propellers.

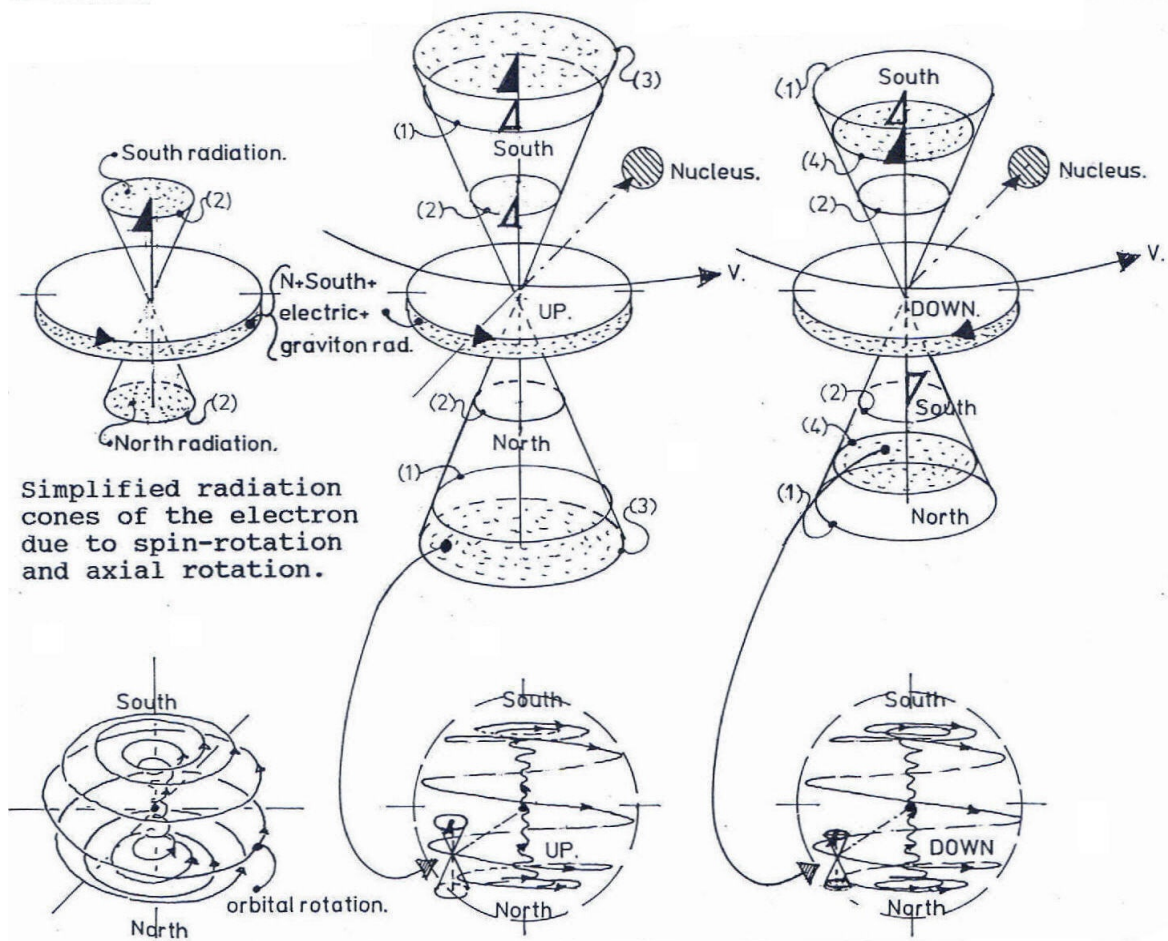

Figure 9, The difference between up and down Atoms.

Suggestion for the W+ and Z particles.

The W particles could harbour one or two extra valence Electrons or Positrons to explain the recent so called Tevatron Bump at about 145 GeV, inside Fermilab's Tevatron collider.

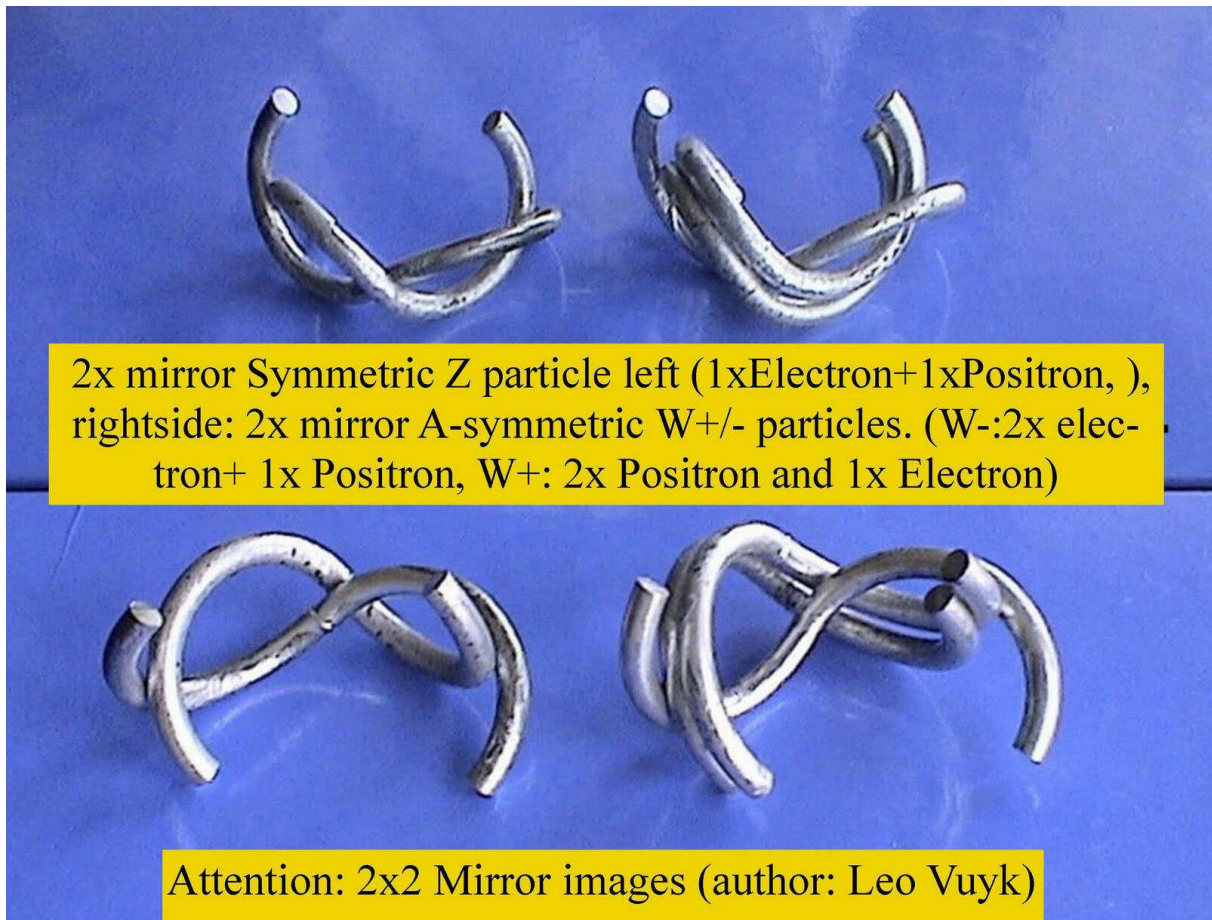

Figure 10 ,

We may observe below in figure 11, the Q-FFF model images, that there is geometrical room for additional Gluons to the Top Quark of the 36 standard models to create a heavier Top Quark.

Even additional Electrons or Positrons could be the origin of additional so called TOP Prime Quarks recently found at the Tevatron.

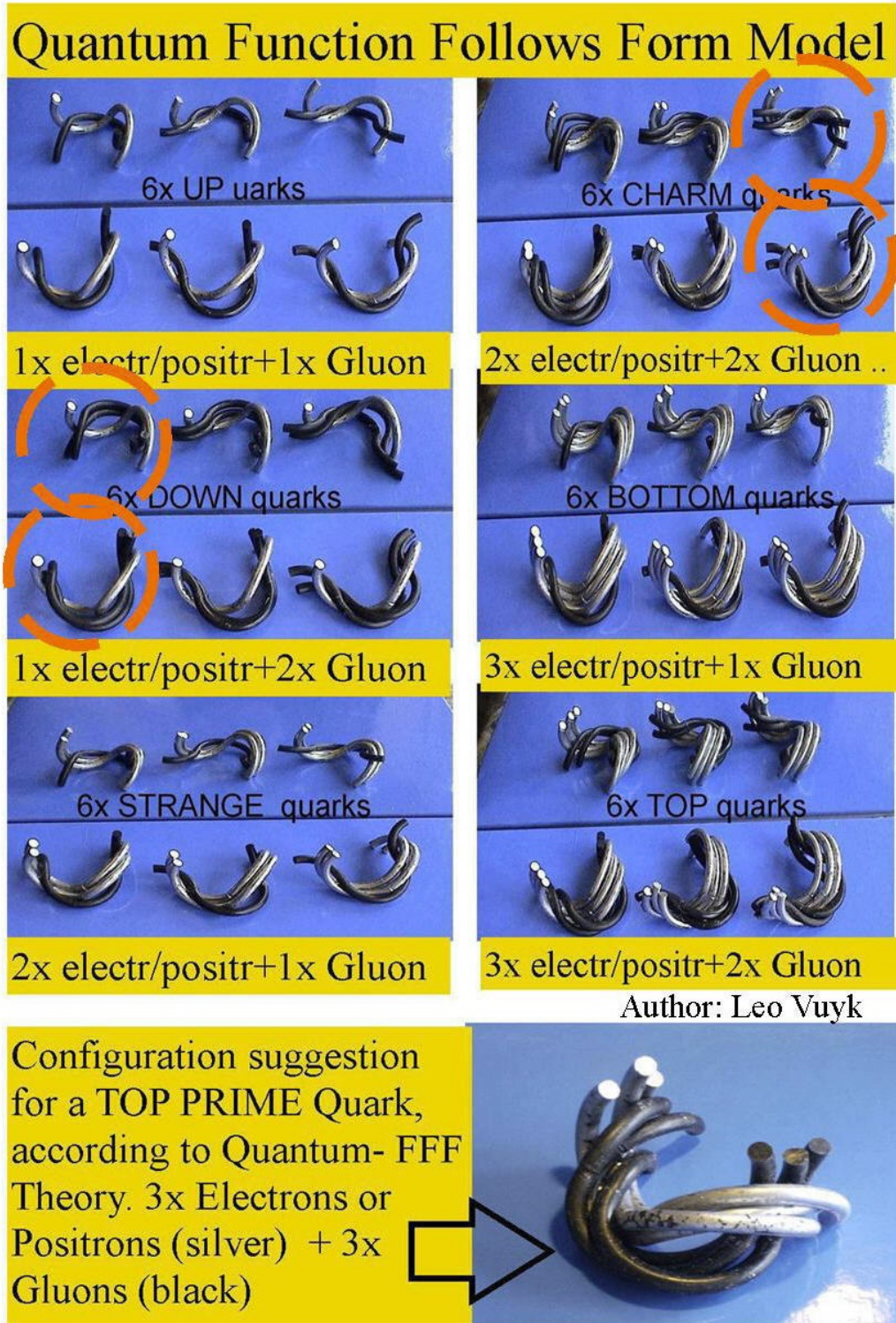

Figure 11, (in orange encircling: the assumed Muon (naked down quarks) and Tauon particles (naked Charm quarks))

The Higgs Torus (Macaroni/Pasta shaped) particle.

The Higgs Torus particle is designed as a real 3D Shape-transformable Particle, to model and mimic the sub-quantum structure of all known Particles described by the “standard model” and beyond the standard model, (monopoles, Gluons) to be able to explain even the most complex and weird particle decay processes like the Kaon decay.

Only spinning particles gain mass by the production of gravitons out of the collision process with massless Higgs particles

Decay examples:

Muon decay.

The Muon decaying compound “click-on” Particle (see Below) coded: (ORO,LOL,LOL). Is able to decay into three single parts: ORO+LRL+LLL. (changing one LOL into a LRL Particle (one hinge rotation over 90 degrees: R>L) and one LOL into a LLL Particle (one hinge rotation over 90 degrees: O>L).

These particles are called: the Electron(ORO), the anti-electro-neutrino (LRL) and the Muonic neutrino (LLL).

Kaon decay.For normal Kaon plus decay, the main decay routes according to the literature are: (A: mu+, Muonic neutrino)or (B: pi+, pi0)

The Kaon + Particle is coded: for the U-Quark:(OLO,ROR)and for the anti-S Quark: (OLO,OLO,ROR).

For the A route: it is proposed that the u-Quark (OLO,ROR)decays into (LLL,ROR) which Particle is supposed to disintegrate and produce the (LLL) Muonic neutrino and one undetected Gluon (ROR) will disappear into the Gluonic “sea”.

The anti-s-Quark (OLO,OLO,ROR)will change into a positive Muon (OLO,ROR,ROR).

For the B route: it is proposed that the U-Quark (OLO,ROR) does not decay and that the anti-S Quark also decays into (OLO,ROR,ROR) which is in combination with the U-Quark a positive pion+ Particle.

The pion-0 Particle coded: U, anti-U Quark: (OLO,ROR), and (ORO,LOL) are mirror symmetric and able to emerge directly from the vacuum as so called pair production results.

Rare Kaon-Plus decay.

A rare Kaon plus Particle decay: $K^+ \Rightarrow \pi^+, \nu, \bar{\nu}$, (pi + , neutrino anti-neutrino) is recently discovered and now acknowledged by a Brookhaven AGS experiment 949:see: <http://www.phy.bnl.gov/949/>

Interestingly this rare Kaon decay can easily be derived from the “Higgs Torus Particle” system properties.

The most simple explanation by this Higgs Particle click-on system is to assume that the decay is the same as route B mentioned before and in addition that the Pion 0 Particle (OLO,ROR)+(ORO,LOL) decays into two neutrinos.(OLO) \Rightarrow (RLR) and (ORO) \Rightarrow (LRL). The (ROR) and (LOL) Gluons are supposed to “disappear into the Gluonic “sea” as described above under route A.

Kaon Long/ Short decay.

It is proposed that the Kaon and anti Kaon Particles (ds)are mixing with themselves and with the Eta (ss) Particle by the continuous changing of one Gluon into a Lepton to change the d Quark into an s Quark and backwards a Lepton into a Gluon from s into a Quark. (d \Leftrightarrow s)

At the same time it is proposed that the backward changing d into s last longer due to the slight chirality of the vacuum .

The angle of attack of the Tandem oscillating Higgs Particles to the Quarks, must be slightly different.

This is reason to propose that it is the S, anti-S (Eta Particle) that is the reason for the strange Kaon decay time-differences

Explanation: the Kaon 0 Particle coded as: d-Quark: (ORO,LOL,LOL) anti-s Quark: (OLO,OLO,ROR) will change into an Eta (s) Particle: s Quark: (ORO,ORO,LOL) anti-s Quark: (OLO, OLO, ROR) by the Direct Weak attack mechanism of the tandem vacuum Particles to change three hinges of one compound Particle at once (OLO \Leftrightarrow ROR, or ORO \Leftrightarrow LOL).

Then after a while, the intermediate (s anti-s) Eta Particle will be changed into the anti-Kano-0, coded: S: (ORO,ORO,LOL) anti-D: (OLO,ROR,ROR,)

Thus it is assumed that the origin of this strange Long and Short Kaon decay mechanism is to find in the difference in transition speed for the LOL Gluon into the ORO Electron (needed to change the d Quark into an s Quark) which is supposed to be faster due to the chirality of the vacuum than the transition speed to change the OLO Positron into the ROR Gluon (needed to change the anti-s Quark into an anti d Quark, to

produce the anti Kaon-0 Particle).

Special Weak Interactions:

The "Direct Weak attack mechanism by the tandem oscillating vacuum Particles" or "two Higgs doublets".

Special Weak interactions are supposed to change all three Hinges at once without the aid of the Z-Particle, such as in Kaon 0,- Eta mixing processes (OLO \leftrightarrow ROR or ORO \leftrightarrow LOL described below).

Glueballs.

(for latest Glueball information see also;

http://arxiv.org/PS_cache/hep-ph/pdf/0209/0209339.pdf)

The shape of some Gluons makes it possible to suggest that these Particles are able to "click-on" to each other WITHOUT THE AID OF ELECTRON or POSITRONS and form so called Glueballs, found already 20 years ago in collider experiments.

Model experiments are pointing into the direction of 10x "bound state, click-on" possibilities for two Gluon Glueballs and also 8x Exotic "bound state, click-on" possibilities of Gluons with single Leptons (ORO and OLO).

10 different Knots with 2xGluon Bound States:

UOU+ROR, UOU+LOL.

UOU+LOU, UOU+ROU.

LOU+ROU 2x because there is also a second mirror image possible.

ROR+LOU, ROR+ROU.

LOL+LOU, LOL+ROU.

8x different Exotic Knots with Gluon-Lepton Bound States.

OLO+LOU, OLO+ROU.

OLO+LOL, OLO+UOU.

ORO+LOU, ORO+ROU,

ORO+ROR, ORO+UOU.

For comparison, see: 17 masses at

http://arxiv.org/PS_cache/hep-ph/pdf/0209/0209339.pdf

see Page 11 figure 1, comparison between the glueball spectrum and Knot energies.

By: R. Buney.

2x different Knots with 3x Gluon bound states:

3x ROU or 3x LOU.

1x Knot with 4x Gluon bound states:

4x UOU.

This new description of elementary Particles, is based on the idea that Quarks are not single Particles but compound Particles and able to be created out of the Higgs vacuum at once as Particle anti-Particle (Quark) pairs, just like an Electron Positron pair and able to decay into smaller parts. (see figure 1-10)

However according to Q-FFF theory a special kind of glueballs is possible called interference black holes.

If three electromagnetic waves exactly interact under tetrahedron aligned direction, then a special glueball with three composite Em. Gluons (3x LOU or 3x ROU) is supposed to be the “seed” for such a black hole. See figure 12.

There is some evidence for such black hole seeds described in reference: 3. Called: **Artificial Ball Lightning Production and Exploitation Device for Zero Point Electric Energy Usage.**



Figure 12. assumed Em Black hole “seed” (Photo: 3x LOU)

Kitchen Table Models.

Based on real “kitchen table” model binding experiments, it is proposed that the 36 different Quarks of the “Standard model” are composed out of one, two or three Electrons, or Positrons and one or two Gluons, both kept together inside the Quark, by the special shape which these Higgs Particles should have.

All these forms are supposed to be derived by real shape transformation out of only one Particle, called the “Higgs” Particle which should have a special Torus form.

The Torus form is supposed to be equally divided into FOUR rigid quarter parts, (like “Macaroni” tubes) each able to rotate axial relative to the neighbouring Macaroni tubes and change the shape of the original Higgs Torus into more complex shapes.

It is assumed that the unification of Particles is based on a simple 90 degree axial “cutting-edge rotation” of the four quarters of the Higgs Torus form.

This Toy system seems to be surprisingly a simple aid to mimic shapes for elementary Particles, exotic Particles like Glueballs and sub-quantum decay processes.

Higgs (macaroni) Particle model description.

If we imagine a rubber Torus shaped Sealing Ring (say about 4 cm diameter and a thickness to ring diameter ratio of about 1: 7) which we cut in two halves, then we are able to make simple propeller forms out of it, with two different so called “Pitches”.

We are able to make propeller forms with a left handed Pitch, or with a right handed Pitch.

We can do so, by gluing the two halves together again after rotation of one half of the Torus over 90 degrees (left or right rotated), at one of the two cutting edges.

At the same time, for more complex Particles we need to cut the Torus into 4 equal quarters (macaroni parts), connected to each other by so called “Hinges”, which are proposed to be able to rotate axial in steps of 90 degrees.

For each Particle , there has to be only three Hinges which are coded by the mutual rotational displacement possibilities: O(=unchanged circle) ,U (=180 degree rotation), L (=90 degree Left hand rotation) and R (=90 degree Right hand rotation).

As a consequence, the most simple Particle shapes are the two “Pitched Propeller forms” described before, coded ORO and OLO., which we will call arbitrarily the Electron respectively the Positron.

As an other consequence, the Particle with three unchanged hinges is coded: (OOO), which is chosen to be the Higgs-Particle.

A Particle with all three hinges with 90 degrees rotation to the Right relative to the neighbouring quarter part, is called (RRR) for three hinges with 90 degrees rotation left it is coded: (LLL) .

The Particle with three hinges rotated over 180

degrees is coded: (UUU).

However not all possible shapes are needed to mimic the standard model, so Particles with a middle hinge coded U : (XUX) are not used. The only Particles with U coded hinges are: UOU ULU URU LOU and ROU. (UOR and UOL are the same Particles as respectively ROU and LOU.)

Mechanistic particle transformation.

THE RING SHAPED Higgs Particles coded(OOO) are supposed to oscillate in Tandem along so called linear Vacuum Lattices, two by two in opposite directions, as the symmetrical opposite pistons of a boxer engine, as the origin of all energy, spin and mass effects.

This enables the Tandem Higgs Particles (doublets) to change the form of their own Torus into an Electron and Positron pair at the same time and to originate all other oscillations and interactions, as $d \leftrightarrow s$ and $c \leftrightarrow b$.

It is proposed that Photon radiation is the result of mechanical change by collisions between Single Higgs Particles and Quarks or Leptons.

There are 6 different shapes for Photons and 5 of them are supposed to act also as Gluons, because they are able to "click -on" to a Positron or Electron and form Quarks, Muons or Tau Particles.

Weak interaction: The two-Higgs doublets in collision with the Quark connected Gluons, are supposed to be able to change the symmetrical shape of three sorts of Gluons (UOU,ROR and LOL) into

Neutrinos, respectively URU,ULU,RRR,RLR,LRL,LLL)..

In Neutron decay, the LOL (d-Quark:ORO+LOL+LOL) Gluon changes via a Muonic Neutrino LLL

into a Positron OLO (u-Quark: OLO+ROR).(see page 3)

With this Higgs system, it is supposed that Higgs Particles are able to transfer Photonic geometrical information at a linear average speed of $7/4$ the speed of Light.

The expected transfer retardation at the vortexes of the Chiral Tetrahedron vacuum Lattice is included. This should enable the vacuum to mimic the isotropy of the speed of light.

See: <http://home.planet.nl/~vuyk0022/> see: "the Local Anti-Symmetrical Oscillating vacuum Frame" (LASOF)

Summary of the single shaped Particles.

The two simple propeller shaped Particles are coded:

ORO: the Electron.

OLO: the Positron.

Gluons.

There are in contrast with the standard model only 5 Gluons needed to satisfy the standard model colour differences of Quarks.

The Gluons are all 5 able to “click on to the Electron or Positron and form a compound Particles needed for all Quarks the Muon and Tau Particle .

They are coded:

UOU, ROR, LOL, LOU, ROU.

Photons.

There are in contrast with the standard model : 6 different shapes for (Monopole) Photons, 5 of them have the same shape as the Gluons mentioned before, they are: .

UOU= Photon for visible and IR light.

ROR= electric + Photon

LOL= electric – Photon

LOU= magnetic South Photon

ROU= magnetic North Photon

.....
The Graviton ROL (or LOR)= is expected to be the Photon without “click-on” possibilities.

Because of the frequency overlap of gamma and x-ray radiation it could be possible that this radiation is not based on the so called General Photon UOU, but should be coded differently as LOO and ROO.

In that case there are 8 Photons in stead of 6.

Neutrinos.

Neutrinos are supposed to be NOT able to “click-on” with compound fermions as Gluons do.

In contrast Neutrinos are supposed to be originated as collision products out of the shape of one of the 5 Gluons or Electron or Positron by the standard Weak Z-Particle operation

Neutrinos with codes and origin Particles:

RRR: the anti-Muon-neutrino. Possible origin

Particles: ROR, ORO

LLL: the Muon-neutrino. LOL, OLO

RLR: the electro-neutrino. ROR, OLO

LRL: the anti-electro-neutrino. LOL, ORO

URU: the Tau-neutrino. UOU.

ULU: the anti-Tau-neutrino. UOU.

The Z-Particle.

The Z-Particle is supposed to be a very loose “click-on” compound combination of an Electron (ORO) and a Positron (OLO).

The W-Particle is not assumed to exist as a single Particle, it is assumed to be a Particle changing

process, in combination with the “aiding” Z-Particle.
The Z Particle is supposed to be a help by form
changing processes of Standard Weak interactions
(described above).

Quark generations.

The three different coloured Up-Quarks are coded:

ORO+LOL, or ORO+LOU, or ORO+UOU. (2 compound
Particles)

Anti-Up-Quarks (three colours) are coded:

OLO+ROR, or OLO+ROU, or OLO+UOU. (2 compound
Particles)

Down-Quarks (three colours) are coded:

ORO+2.LOL, or ORO+2.LOU, or ORO+2.UOU. (3 compound
Particles)

anti-Down-Quarks (three colours) are coded:

OLO+2.ROR, or OLO+2.ROU, or OLO+2.UOU. (3 compound
Particles)

The three different coloured Strange-Quarks are coded:

2.ORO+LOL, 2.ORO+LOU, or 2.ORO+UOU. (3 compound
Particles)

Anti-Strange-Quarks (three colours) are coded:

2. OLO+ROR, 2.OLO+ROU, or 2.OLO+UOU. (3 compound
Particles .

Charm-Quarks (three colours) are coded:

2.ORO+2.LOL, 2.ORO+2.LOU, or 2.ORO+2.UOU. (4 compound
Particles)

anti-Charm-Quarks (three colours) are coded:

2.OLO+2.ROR, 2.OLO+2.ROU, or 2.OLO+2.UOU. (4 compound
Particles)

The three different coloured Bottom-Quarks are coded:

3.ORO+LOL, 3.ORO+LOU, or 3.ORO+UOU. (4 compound
Particles)

Anti-Bottom-Quarks (three colours) are coded:

3. OLO+ROR, 3.OLO+ROU, or 3.OLO+UOU. (4 compound
Particles)

Top-Quarks (three colours) are coded:

3.ORO+2.LOL, 3.ORO+2.LOU, or 3.ORO+2.UOU. (5 compound
Particles)

anti-Top-Quarks (three colours) are coded:

3.OLO+2.ROR, 3.OLO+2.ROU, or 3.OLO+2.UOU. (5 compound
Particles)

Compound Leptons: Muon Particles are coded: mu+: OLO+2ORO,
(=anti-d-Quark) mu-: ORO+2.LOL.(=d-Quark)

Tau Particles are coded: tau+: 2.OLO+2UOU, (=c-Quark).

tau-: 2ORO+2UOU.(=anti-c-Quark)

Counting Particles. I count: 6 Photons (Gluons included) , 6 single

neutrinos, 2 single Leptons and one single Higgs-Particle= 17 single Particles. +36 compound Quarks and one compound Z Particle = 54 different formed functional Particles if we exclude exotic Particles like Glueballs etc.(see below)

MATTER CREATION AND THE CHIRAL VACUUM.

A new reason for a dual-symmetrical smooth evaporation of multiple anti-mirror universes in an alternative Big Bang process, is based on the new system for elementary Particles, described before and the chirality of the Higgs-Particle based vacuum . The chirality of the vacuum , should be responsible, for our material universe, because it is assumed that anti-matter is less stable than matter within the moment of creation in a chiral oscillating vacuum after the “semi-cold Higgs particles evaporating Big Bang”. Thus Matter in our universe, is supposed to be created without enormous annihilation processes, direct out of the evaporated vacuum Higgs-Particles. At a result, the chirality of the vacuum should be responsible for the origin of strange CP violations found in the so called Kaon- O Short and Long decay.

References:

- [1] [viXra:1111.0096](#) *submitted on 2011-11-29* **Reconciliation of QM and GR and the Need for a Pulsating Entangled CPT Symmetric Raspberry Shaped Multiverse.**
- [2] [viXra:1111.0061](#) *submitted on 15 Nov 2011* **Black Hole Horizon Curvature Dependent Balance Between Plasma Creation and e-e+ Annihilation in Quantum FFF Theory.**
- [3] [viXra:1108.0036](#) *replaced on 21 Sep 2011* **Artificial Ball Lightning Production and Exploitation Device for Zero Point Electric Energy Usage.**
- [4] [viXra:1108.0006](#) *submitted on 3 Aug 2011* **Mass in Motion in Quantum FFF Theory**
- [5] [viXra:1104.0083](#) *submitted on 28 Apr 2011* **Quantum FFF Theory in Posters.**
- [6] [viXra:1104.0044](#) *submitted on 13 Apr 2011*

Ball Lightning, Micro Comets, Sprite-Fireballs and X-Ray/gamma Flashes According to Quantum FFF Theory

[7] [viXra:1104.0002](#) *submitted on 1 Apr 2011*

Stellar Anchor Black Holes as the Remnants of Former Herbig Haro Objects

[8] [viXra:1103.0097](#) *submitted on 23 Mar 2011*

ZPE Zero Point Energy Examples Around Black Holes.

[9] [viXra:1103.0068](#) *submitted on 16 Mar 2011*

Funktion Follows Form, at the Quantum Scale and Beyond.

[10] [viXra:1103.0024](#) *replaced on 24 Mar 2011*

Quantum Gravity and Electro Magnetic Forces in FFF-Theory.

[11] [viXra:1103.0015](#) *submitted on 5 Mar 2011*

Wavefunction Collapse and Human Choice-Making Inside an Entangled Mirror Symmetrical Multiverse.

[12] [viXra:1103.0011](#) *submitted on 3 Mar 2011*

An Alternative Black Hole, Provided with Entropy Decrease and Plasma Creation.

[13] [viXra:1103.0002](#) *replaced on 2011-12-3*

Dimensional String Based Alternative Particles Model

[14] [viXra:1102.0056](#) *submitted on 28 Feb 2011*

Experiments to Determine the Mass Related Lightspeed Extinction Volume Around the Earth and Around Spinning Objects in the Lab.

[15] [viXra:1102.0054](#) *submitted on 27 Feb 2011*

Atomic Nuclear Geometry Based on Magic Number Logic.

[16] [viXra:1102.0052](#) *submitted on 27 Feb 2011*

Construction Principles for Chiral "atoms of Spacetime Geometry".

Authors: [Leo Vuyk](#)

[17] Book: "The New God Particle and Free Will".

Author: Leo Vuyk, LuLu publishers, 2008.

ISBN number 978-1-4092-1031-3

<http://www.amazon.co.uk/NEW-GOD-PARTICLE-FREE-WILL/dp/1409210316>

[18] E-Book: "Zero Point Energy Black Holes"

Author: Leo Vuyk, LuLu publishers, 2011.

<http://www.lulu.com/product/ebook/zero-point-energy-black-holes/152399515>

[19] J. Abrahamson and James Dinniss, "Ball lightning caused by oxidation of nanoparticle networks from normal lightning strikes on soil," *Nature*, Vol. 403, 3

February 2000, pp. 519-521

[20] G.S. Paiva, A.C. Pavao, E.A. de Vasconcelos, O. Mendes jr., and E.F. da Silva jr., "Production of Ball-Lightning Like Luminous Balls by Electrical Discharge in Silicon," *Phys. Rev. Letters*, PRL 98, 048501 (2007), January 2007

[21] <http://www.newscientist.com/article/mg19325863.500-lightning-balls-created-in-the-lab.html>

[22] **Artificial Ball Lightning produced in the laboratory !?**

M. Goossens, P. de Graaf, R. Dekker.

<http://www.dos4ever.com/bolbliksem/bolbliksem.html>