

# THE BASES OF THE UNIFYING THEORY OF PHYSICS

**MIHAI Gheorghe**

**University of Craiova, Faculty of Electrotechnics, Romania**

*E-mail address:* [gmihai@elth.ucv.ro](mailto:gmihai@elth.ucv.ro)

## FOREWARD

*In this book, a new theory is developed which has as a starting point the Planck quantum of mass-space-time and can answer the five big unsolved problems of modern physics:*

- *the unification of general relativity with quantum mechanics;*
- *deterministic formulation of fundamentals of quantum mechanics;*
- *the description of different particles and forces in physics using one single theory;*
- *the elimination of adjustable variables in physics of elementary ;*
- *the nature of the phenomena known as the dark energy.*

## C O N T E N T

1. Introduction.....	6
2. The fundamental proposed postulates .....	7
2.1. The fundamental philosophical postulates.....	7
2.2. The fundamental physical postulates.....	7
3. General relativity.....	8
3.1. The equations of gravitational field.....	8
3.2. Schwarzschild metric.....	13
<i>Conclusions</i> .....	15
4. Some properties of the mass-space-time Planck quanta.....	16
4.1. The dimensions of the mass-space-time Planck quanta.....	16
4.2. The structure of the mass-space-time Planck quanta.....	17
4.3. The electrical charge quantum.....	19
<i>Conclusions</i> .....	21
5. The mass of the elementary particles.....	22
5.1. The geometric dimensions of the elementary particles.....	22
5.1.1. Poisson coefficient.....	25
5.2. The mass of the charged hyperions.....	26
5.2.1. The internal energetic process.....	26
5.2.2. The mass of the charged meson $\pi^\pm$ and the charged lepton $\mu^\pm$ .....	28
5.2.3. Deducing the oscillation conditions for the mesons $\pi^\pm$ and leptons $\mu^\pm$ .....	29
5.2.3.1. The calculation of the meson's $\pi^\pm$ mass.....	31
5.2.3.2. The calculation of the lepton's $\mu^\pm$ mass.....	32
5.3. The relativistic transformation of the internal mass.....	34
5.4. The external energetic process.....	35
5.4.1. The electron's mass in its own reference system.....	35

---



---

5.4.2. The electron's mass in uniform and rectilinear relativist motion.....	37
5.4.3. Relativistic transformation of the electron's mass.....	38
5.5. Heisenberg's uncertainty relations.....	39
<i>Conclusions</i> .....	44
6. Gravitational interaction.....	45
6.1.Gravitational interaction based on the internal mass of the particles .....	45
6.1.1. The gravitational interaction between two bodies of masses $m_1$ and $m_2$ .....	47
6.2. Gravitational interaction expressed in function of the external mass $m_{ext}$ .....	48
<i>Conclusions</i> .....	49
7. Electrical interaction.....	50
7.1. Coulomb's law.....	50
7.2. The interaction between the polarized electrical charges.....	53
<i>Conclusions</i> .....	57
8. The inertial and gravitational mass.....	58
8.1 The inertial and gravitational mass of internal nature.....	58
8.1.1. The inertial and gravitational mass of internal nature in the space of Euclidian metric.....	59
8.1.1.1. Uniform motion.....	59
8.1.1.2. Circular motion.....	61
8.1.2. The inertial and gravitational mass of internal nature in the space of Schwarzschild metric.....	63
8.1.2.1. Radial motion.....	63
8.1.2.2. Circular motion.....	64
8.2. The inertial and gravitational mass of external nature (electrical).....	65
8.2.1. The inertial and gravitational mass of external nature in the space of Euclidian metric.....	65
8.2.1.1.Uniform motion.....	65
8.2.1.2. Circular motion.....	66

8.2.2. The inertial and gravitational mass of external nature in the space of Schwarzschild metric.....	68
8.2.2.1. Radial motion.....	68
8.2.2.2. Circular motion.....	69
<i>Conclusions</i> .....	70
9. Strong interaction.....	71
9.1. Nuclear interaction.....	71
9.2.The magnetic momentum and the mechanical momerntum of the elementary particles.....	74
9.2.1. The exterior mechanical momentum.....	74
9.2.2. The disintegration of the electrically charged hyperions.....	75
9.2.2.1. The disintegration of the hyperions $\Sigma^{\pm}, E^{\pm}, \Omega^{\pm}$ ...	75
<i>Conclusions</i> .....	80
10. Quantum mechanics.....	81
10.1. The fundamental theorems of the quantum mechanics.....	81
10.2. The measuring problem in quantum mechanics.....	82
10.3.Schrödinger's equation for spin-less particles.....	83
10.3.1. Schrödinger's operator.....	83
10.3.2. Schrödinger's equation for a particle placed in a field of force of potential energy $E_p$ .....	85
10.3.2.1. The potential energy $E_p(x, y, z)$ is invariant in time.....	85
10.3.2.2. The potential energy $E_p(t)$ is a function of time .....	87
10.3.2.3 Schrödinger's operator for a system of particles.....	88
10.3.2.4 Schrödinger's operator for a particule found in the electromagnetic field .....	90
10.4. Fundamental operators in quantum mechanics.....	92
10.4.1. The impulse operator.....	92
10.4.2. The deduction of the kinetic momentum operator.....	93

10.5. Obtaining Dirac's operator.....	95
<i>Conclusions</i> .....	98
11. Electrodynamics.....	99
11.1. The electromagnetic law of induction (Maxwell's second law).....	99
11.2. The law of the magnetic circuit (Maxwell's first law).....	101
11.3. Lorentz calibration.....	103
<i>Conclusions</i> .....	104
12. Thermodynamics .....	105
12.1.The electrostatics theory of the thermodynamics.....	105
12.1.1 The electromagnetic radiation of the neuter atoms.....	105
12.1.2. Fourier's law of thermoconduction.....	106
12.1.3. The equation of heat propagation.....	109
12.2. The entropy.....	110
12.3. V. Karpen phenomenon.....	112
<i>Conclusions</i> .....	113
13. Cosmology and the arrow of time.....	114
13.1. The physical fundamentals of space and time.....	114
13.2. What does the elapsing of time represents.....	117
13.3. The space-time dimensions of the Universe.....	119
13.4. Dual Universes.....	124
<i>Conclusions</i> .....	127
Bibliography.....	128
Special Bibliography.....	129

## 1. INTRODUCTION

The “**unifying theory of physics**” implies having a physical theory that would be able to describe in a coherent manner, the whole interactions of the fundamental forces.

Such a theory has not yet been found.

The main cause is the impossibility of finding a description of gravity which is compatible with quantum mechanics. The major difficulty in finding a theory that would unify gravitation with quantum mechanics and the theory of elementary particles, is the fact that general relativity is a classical, macroscopic theory, that does not include the uncertainty principle from quantum mechanics.

*“The unifying theory should not contain free parameters and adjustable charges or masses. The Planck scale should be used as a starting point and also as the scale at which the measurements should be done“.* [15].

When it comes to the interconnection and transformation of the elementary particles, the problem that should be solved is extremely difficult, because at this moment, one can not tell which particles are more ‘elementary’ than others and which are ‘made’ of which.

From the general interdependency of particles, it results that ‘each elementary particle is composed in a certain degree of all the other particles, meaning that they have something in common, something unique, some kind of primary, general matter’. [12].

## 2. THE FUNDAMENTAL PROPOSED POSTULATES

### 2.1. The philosophical fundamental postulates

At the bottom of the proposed theory stand the philosophical conceptions of dialectic materialism:

- PF.1. The universe consists of substance and field.
- PF.2. The matter is based on the fight of the contraries.
- PF.3. The matter is continuously moving and transforming.
- PF.4. Knowing the matter has no limits.

### 2.2. The fundamental physical postulates

P1. Matter is based on three fundamental physical constants:

- Newtonian constant of gravitation:  $G = 6,67 \cdot 10^{-11} N \cdot m^2 / kg^2$
- Planck constant:  $\hbar = 1,0546 \cdot 10^{-34} J \cdot s$
- the velocity of light in vacuum:  $c_0 = 3 \cdot 10^8 m / s$

P2. The fundamental 'atoms' of space have Planck dimensions.

P3. Planck quantum of space is formed of two components:

- Planck quantum of space with positive sign;
- Planck quantum of space with negative sign.

P4. The space quantum components can move relatively between them.

P5. At macroscopic scale, the vacuum forms a continuous medium, which is governed by the principles of elasticity theory.

### 3. GENERAL RELATIVITY

#### 3.1. The equations of gravitational field

In the presented theory, the vacuum is imagined as a discontinuous medium formed of Planck domains. At macroscopic scale, compared to Planck scale, the vacuum forms a continuous medium. We can consider that at this scale, no perturbation takes action.

Each point in space is characterized by its position vector  $\bar{r}$ , of coordinates:  $x_1 = x, x_2 = y, x_3 = z$ .

In these conditions, the metric space before the distortion is an Euclidian metric:

$$dl^2 = dx_1^2 + dx_2^2 + dx_3^2 \quad (3.1)$$

After distortion, a point of  $\bar{r}$  radius, will have the position vector  $\bar{r}'(x'_1, x'_2, x'_3)$ , so that  $dl$  becomes:

$$dl'^2 = g_{ik} dx^i dx^k \quad i, k = 1, 2, 3 \quad (3.2)$$

If the distortion tensor is reduced to the points near the main axes, then relation (3.2) takes the form:

$$dl'^2 = [1 + \varepsilon F_1(x, y, z)] \cdot dx^2 [1 + \varepsilon F_2(x, y, z)] \cdot dy^2 [1 + \varepsilon F_3(x, y, z)] \cdot dz^2 \quad (3.3)$$

In the above mentioned relation,  $\varepsilon$  represents a small, constant parameter, meanwhile  $F_1(x, y, z), F_2(x, y, z), F_3(x, y, z)$  are continuous functions,  $n$  times derivable. The analytical expression of these functions will be determined afterwards.

From the general equilibrium equations for continuous and deformable mediums, [9] it results the relation:



$$\frac{1}{\sqrt{\mathbf{g}}} \partial_k (\sqrt{\mathbf{g}} T^{ik}) + \Gamma_{\alpha k}^i T^{\alpha k} = 0 \quad i, k = 1, 2, 3 \quad (3.4)$$

We demonstrate that in order to verify relation (3.4), the tensor  $T^{ik}$  should take the form:

$$T^{ik} = K \left( R^{ik} - \frac{1}{2} g^{ik} R \right) \quad i, k = 1, 2, 3 \quad (3.5)$$

Using the expression for the metric tensor in (3.3), it results that:

$$\mathbf{g} = [1 + \varepsilon F_1(\mathbf{x}, \mathbf{y}, \mathbf{z})] \cdot [1 + \varepsilon F_2(\mathbf{x}, \mathbf{y}, \mathbf{z})] \cdot [1 + \varepsilon F_3(\mathbf{x}, \mathbf{y}, \mathbf{z})] \quad (3.6)$$

We neglect the superior, infinite small terms of  $\varepsilon$  and we calculate the six components of the curvature tensor in three dimensional spaces [9].

$$\left\{ \begin{array}{l} R_{12,12} = -\frac{\varepsilon}{2} \left( \frac{\partial^2 F_1}{\partial y^2} + \frac{\partial^2 F_2}{\partial x^2} \right) \\ R_{13,13} = -\frac{\varepsilon}{2} \left( \frac{\partial^2 F_1}{\partial z^2} + \frac{\partial^2 F_3}{\partial x^2} \right) \\ R_{23,23} = -\frac{\varepsilon}{2} \left( \frac{\partial^2 F_2}{\partial z^2} + \frac{\partial^2 F_3}{\partial y^2} \right) \\ R_{12,13} = -\frac{\varepsilon}{2} \frac{\partial^2 F_1}{\partial y \partial z} \\ R_{12,23} = -\frac{\varepsilon}{2} \frac{\partial^2 F_2}{\partial x \partial z} \\ R_{13,23} = -\frac{\varepsilon}{2} \frac{\partial^2 F_3}{\partial x \partial y} \end{array} \right. \quad (3.7)$$

From the above mentioned relations, we find the components of the contracted curvature tensor.

$$\left\{ \begin{array}{l}
 R_{11} = \frac{\varepsilon}{2} \left( \frac{\partial^2 F_1}{\partial y^2} + \frac{\partial^2 F_1}{\partial z^2} + \frac{\partial^2 F_2}{\partial x^2} + \frac{\partial^2 F_3}{\partial x^2} \right) \\
 R_{22} = \frac{\varepsilon}{2} \left( \frac{\partial^2 F_2}{\partial z^2} + \frac{\partial^2 F_2}{\partial x^2} + \frac{\partial^2 F_3}{\partial y^2} + \frac{\partial^2 F_1}{\partial y^2} \right) \\
 R_{33} = \frac{\varepsilon}{2} \left( \frac{\partial^2 F_3}{\partial x^2} + \frac{\partial^2 F_3}{\partial y^2} + \frac{\partial^2 F_1}{\partial z^2} + \frac{\partial^2 F_2}{\partial z^2} \right) \\
 R_{12} = -\frac{\varepsilon}{2} \frac{\partial^2 F_3}{\partial x \partial y} \\
 R_{13} = \frac{\varepsilon}{2} \frac{\partial^2 F_2}{\partial x \partial z} \\
 R_{23} = \frac{\varepsilon}{2} \frac{\partial^2 F_1}{\partial y \partial z}
 \end{array} \right. \quad (3.8)$$

The linear invariant of the curvature tensor is:

$$R = \varepsilon \left( \frac{\partial^2 F_1}{\partial y^2} + \frac{\partial^2 F_1}{\partial z^2} + \frac{\partial^2 F_2}{\partial x^2} + \frac{\partial^2 F_2}{\partial z^2} + \frac{\partial^2 F_3}{\partial x^2} + \frac{\partial^2 F_3}{\partial y^2} \right) \quad (3.9)$$

From relations (3.8) and (3.9), in which we substitute  $\mathbf{K} = \varepsilon^{-1}$  and replace it afterwards in relation (3.5), we obtain:

$$\left\{ \begin{array}{l}
 T^{11} = -\frac{1}{2} \left( \frac{\partial^2 F_2}{\partial z^2} + \frac{\partial^2 F_3}{\partial y^2} \right) \\
 T^{22} = -\frac{1}{2} \left( \frac{\partial^2 F_3}{\partial x^2} + \frac{\partial^2 F_1}{\partial z^2} \right) \\
 T^{33} = -\frac{1}{2} \left( \frac{\partial^2 F_1}{\partial y^2} + \frac{\partial^2 F_2}{\partial x^2} \right) \\
 T^{12} = -\frac{1}{2} \frac{\partial^2 F_3}{\partial x \partial y} \\
 T^{13} = -\frac{1}{2} \frac{\partial^2 F_2}{\partial x \partial z} \\
 T^{23} = -\frac{1}{2} \frac{\partial^2 F_1}{\partial z \partial y}
 \end{array} \right. \quad (3.10)$$

On the other hand, from the elasticity theory, we have Cauchy's equilibrium equations, which if we apply to a linear, homogenous and isotropic medium, will lead to:

$$\begin{cases} \frac{\partial^2 \sigma_{xx}}{\partial x^2} + \frac{\partial^2 \tau_{xy}}{\partial x \partial y} + \frac{\partial^2 \tau_{xz}}{\partial x \partial z} = 0 \\ \frac{\partial^2 \sigma_{yy}}{\partial y^2} + \frac{\partial^2 \tau_{yx}}{\partial y \partial x} + \frac{\partial^2 \tau_{yz}}{\partial y \partial z} = 0 \\ \frac{\partial^2 \sigma_{zz}}{\partial z^2} + \frac{\partial^2 \tau_{zx}}{\partial z \partial x} + \frac{\partial^2 \tau_{zy}}{\partial z \partial y} = 0 \end{cases} \quad (3.11)$$

where  $\sigma_{xx}, \sigma_{yy}, \sigma_{zz}, \tau_{xy}, \tau_{xz}, \tau_{yz}$  represent the unitary efforts.

The equation of continuity:

$$\nabla^2(\sigma_{xx} + \sigma_{yy} + \sigma_{zz}) = 0 \quad (3.12)$$

Can be expressed using functions  $F_1(x, y, z), F_2(x, y, z), F_3(x, y, z)$ , if the unitary efforts have the following expressions:

$$\begin{cases} \sigma_{xx} = \frac{1}{2} \left( \frac{\partial^2 F_3}{\partial y^2} + \frac{\partial^2 F_2}{\partial z^2} \right) \\ \sigma_{yy} = \frac{1}{2} \left( \frac{\partial^2 F_1}{\partial z^2} + \frac{\partial^2 F_3}{\partial x^2} \right) \\ \sigma_{zz} = \frac{1}{2} \left( \frac{\partial^2 F_2}{\partial x^2} + \frac{\partial^2 F_1}{\partial y^2} \right) \\ \tau_{xy} = \frac{1}{2} \frac{\partial^2 F_3}{\partial x \partial y} \\ \tau_{yz} = \frac{1}{2} \frac{\partial^2 F_1}{\partial y \partial z} \\ \tau_{zx} = \frac{1}{2} \frac{\partial^2 F_2}{\partial z \partial x} \end{cases} \quad (3.13)$$

In the last three equations from (3.13), we apply the disharmonic operator  $\nabla^4$  and we obtain:

$$\begin{cases} \nabla^4 \tau_{xy} = \frac{1}{2} \frac{\partial^2}{\partial x \partial y} (\nabla^4 F_3) \\ \nabla^4 \tau_{yz} = \frac{1}{2} \frac{\partial^2}{\partial y \partial z} (\nabla^4 F_1) \\ \nabla^4 \tau_{zx} = \frac{1}{2} \frac{\partial^2}{\partial z \partial x} (\nabla^4 F_2) \end{cases} \quad (3.14)$$

In the theory of elasticity, it is demonstrated that the unitary efforts  $\sigma_{xx}, \sigma_{yy}, \sigma_{zz}, \tau_{ky}, \tau_{xz}, \tau_{yz}$  verify the biharmonic equation. [10]. From relations (3.14), it results that the functions  $F_1(\mathbf{x}, \mathbf{y}, \mathbf{z})$ ,  $F_2(\mathbf{x}, \mathbf{y}, \mathbf{z})$  și  $F_3(\mathbf{x}, \mathbf{y}, \mathbf{z})$ , are solutions of the biharmonic equation. From the condition for the deformity to annulate at infinite, it results that they have the form :

$$U = \pm \frac{a}{r} \quad (3.15)$$

where:  $r = \sqrt{x^2 + y^2 + z^2}$

The constant  $a$  has dimension of length and will be determined in paragraph. The negative sign corresponds to the compression of elastic medium; meanwhile the positive sign corresponds to the elongation of the elastic medium. We return to relations (3.10) and (3.13) and we observe that:

$$\begin{cases} T^{11} = -\sigma_{xx} & T^{12} = -\tau_{xy} \\ T^{22} = -\sigma_{yy} & T^{13} = -\sigma_{xz} \\ T^{33} = -\sigma_{zz} & T^{23} = -\sigma_{yz} \end{cases} \quad (3.16)$$

The equations of gravitational field or Einstein's equations represented by relations (3.5) can be obtained from the theory of elasticity if the vacuum is considered a linear, homogenous and isotropic medium.

### 3.2. Schwarzschild metric

By identifying the vacuum with an elastic body, this will lead to the conclusion that there are two propagation velocities of the elastic waves: transversal and longitudinal. So:

- The velocity of longitudinal waves is given by expression [10]:

$$c_{0l} = \sqrt{\frac{E(1-\sigma)}{\rho(1+\sigma)(1-2\sigma)}} \quad (3.17)$$

- The velocity of transversal waves is given by expression:

$$c_{0t} = \sqrt{\frac{E}{2\rho(1+\sigma)}} \quad (3.18)$$

where:

$E$  is Young's modulus;

$\rho$  = density of matter;

$\sigma$  = Poisson's coefficient.

From relations (3.17) and (3.18) we obtain:

$$\frac{c_{0l}}{c_{0t}} = \sqrt{\frac{1-\sigma}{2(1-2\sigma)}} \quad (3.19)$$

We will return to relation (3.19) when we will calculate the value of Poisson's coefficient, in paragraph 5.1.1.

From relations (3.17) and (3.18), one can tell that both the velocities of the transversal elastic waves and of the longitudinal elastic waves are a constant, depending only on the local parameters of elastic medium (the vacuum).

The calculation of the propagation velocity of the waves in a point in the deformed space has as a starting point the linear invariant of the tensor for the kinetic tensions. Let  $\nu$  be the velocity of a Planck quantum of deformed space. The linear invariant of the tensor for the kinetic tensions can be expressed as follows [9]:

$$I_1 = \rho(1 + v^2) - (\sigma_{xx}^2 + \sigma_{yy}^2 + \sigma_{zz}^2) \quad (3.20)$$

By applying the operator  $\nabla^4$  to relation (3.20), we obtain:

$$\nabla^4 v^2 = 0 \quad (3.21)$$

From relation (3.21) it results that the velocity has to have the form:

$$v(r) = b \left( 1 - \frac{a}{r} \right) \quad (3.22)$$

At large distances, where there are no deformations, the constant  $b$  is identical with  $c_0$ , so that we obtain in the end:

$$v(r) = c(r) = c_0 \left( 1 - \frac{a}{r} \right) \quad (3.23)$$

Based on relations (3.3), (3.15) and (3.23) written after the radius  $r$ , the metric of the deformed space in respect to the undiformed space, can be expressed in the following manner:

$$ds^2 = \frac{dr^2}{1 - \frac{a}{r}} - c_0^2 \left( 1 - \frac{a}{r} \right) dt^2 \quad (3.24)$$

The static metric, central symmetric of K. Schwarzschild, is obtained from relation (3.24) and has the form:

$$ds^2 = \frac{dr^2}{1 - \frac{a}{r}} + r^2 (d\vartheta^2 + \sin^2 \vartheta d\varphi^2) - c_0^2 \left( 1 - \frac{a}{r} \right) dt^2 \quad (3.25)$$

## CONCLUSIONS

- *The equations of gravitational field or Einstein's equations, represented by relations (3.5), can be obtained from the elasticity theory, if we consider vacuum as a linear, homogenous and isotropic medium;*
- *The vacuum is characterized by the existence of two velocities: the velocity of transversal waves and the velocity of longitudinal waves;*
- *The velocity of waves in vacuum is determined by its local parameters.*

#### 4. SOME PROPERTIES OF THE MASS-SPACE-TIME PLANCK QUANTA

##### 4.1. The dimensions of the mass-space-time Planck quanta

For start, we consider already known all the necessary formulas, from both the general relativity and the quantum mechanics. These formulas will be completely demonstrated in chapters 6, 8 and 10.

We introduce the notations:

-  $r_{pl}$  = Planck length;

-  $m_{pl}$  = Planck mass;

-  $t_{pl}$  = Planck time.

From Heisenberg's relation, we obtain:

$$r_{pl} = \frac{\hbar}{2m_{pl}c_0} \quad (4.1)$$

And from general relativity, we get the gravitational radius [5]:

$$r_g = \frac{2Gm_{pl}}{c_0^2} \quad (4.2)$$

If we equal relations (4.1) and (4.2), we obtain in the end:

$$m_{pl} = \frac{1}{2} \sqrt{\frac{c_0 \hbar}{G}} \quad (4.3)$$

$$r_{pl} = \sqrt{\frac{G\hbar}{c_0^3}} \quad (4.4)$$



$$\mathbf{t}_{pl} = \frac{\mathbf{r}_{pl}}{c_0} = \sqrt{\frac{G\hbar}{c_0^5}} \quad (4.5)$$

The kinetic moment of Planck quantum can be obtained from relations (4.3) and (4.4) and is equal to:

$$\mathbf{S}_{pl} = \mathbf{r}_{pl} \cdot \mathbf{m}_{pl} \cdot \mathbf{c}_0 = \frac{\hbar}{2} \quad (4.6)$$

#### 4.2. The structure of the mass-space-time Planck quanta

Accordingly to postulate P.3, Planck mass is formed of two components: the mass of the positive space  $m_s$  and the mass of the negative space (antispaces)  $m_{as}$ .

$$m_s = \frac{1}{2} m_{pl} \quad (4.7)$$

$$m_{as} = \frac{1}{2} m_{pl} \quad (4.8)$$

Each component is made of a corpuscular component and a field component.

Accordingly to postulates PF.1, the corpuscular component  $m_{cs}$  from relation (4.7) and  $m_{cas}$  from relation (4.8), generates a field, which has an energy and to which it corresponds a mass:

- The field mass of space  $m_{fs}$
- The field mass of antispaces  $m_{fas}$ .

In order to determine the potential  $U_{pl}$  of the generated field by the  $m_{cs}$  or  $m_{cas}$ , we will utilise Seelinger's equation, because the space is infinite [7]:

$$\nabla^2 U_{pl} - \lambda^2 U_{pl} = 4\pi G\rho \quad (4.9)$$

where:

$$\lambda \approx \frac{1}{r_{pl}} \quad (4.10)$$

$$\rho = \frac{m_{cs}}{\frac{4\pi}{3} r_{pl}^3} \quad (4.11)$$

The solution for equation (4.9) is [7]:

$$U_{pl} = \frac{4\pi G \rho}{\lambda^2} \quad (4.12)$$

By replacing relations (4.10) and (4.11) in the expression for the potential  $U_{pl}$ , then relation (4.12) becomes:

$$U_{pl} = \frac{3Gm_{cs}}{r_{pl}} \quad (4.13)$$

On the surface of Planck's sphere, the Seelinger's potential,  $U_{pl}$ , generated by  $m_{cs}$ , and the Newton's potential,  $U_N$ , generated by  $m_s$ :

$$U_N = \frac{Gm_s}{r_{pl}} \quad (4.14)$$

have to be equal.

From relations (4.13) and (4.14), it results that:

$$m_{cs} = \frac{m_s}{3} \quad (4.15)$$

Based on relation (4.7), relation (4.15) becomes:

$$m_{cs} = \frac{m_{pl}}{6} = \frac{1}{12} \sqrt{\frac{c_0 \hbar}{G}} \quad (4.16)$$

### 4.3. The electrical charge quantum

The notion of electrical charge is a quantity derived from mass Planck quanta. Accordingly to postulate P3, to the positive electrical charge it corresponds the positive component of the mass Planck quantum, meanwhile to the negative electrical charge it corresponds the negative component of the mass Planck quantum.

We propose to find the connection between the component of the space Planck quantum of mass  $m_{cs}$  and the electrical charge  $q$ .

For start, we consider as known the Newton's formula and Coulomb's formula. Their demonstration will be done in chapters 6 and 7.

At Planck scale, we can equate (in modulus) the Newtonian interaction force with Coulombian interaction force.

$$\frac{Gm_{cs}^2}{r_{pl}} = \frac{q^2}{4\pi\epsilon_0 r_{pl}} \quad (4.17)$$

From relations (4.16) and (4.17), it results:

$$q = \pm \frac{1}{12} \sqrt{4\pi\epsilon_0 \hbar c_0} \quad (4.18)$$

The sign ( $\pm$ ), refers to the existence of the two components of the mass quanta: positive and negative.

The value of the electrical charge quantum calculated with relation (4.18) is equal to  $1,562 \cdot 10^{-19} \text{C}$  in comparison with  $1,602 \cdot 10^{-19} \text{C}$ , which is the measured value. The difference of 2,46 % is due to the approximation done in relation (4.10), when we

have considered  $\lambda$  almost equal to  $\frac{1}{r_{pl}}$ . In order to get theoretical results accordingly

to the ones measured, we will consider:

$$\lambda = \frac{\sqrt{137,0359}}{12} \frac{1}{r_{pl}} \quad (4.19)$$

With the rectification above mentioned, relations (4.15), (4.16) and (4.18), will get the final form:

$$m_{cs} = \frac{4}{\sqrt{137,0359}} m_s \quad (4.20)$$

$$m_{cs} = \frac{1}{\sqrt{137,0359}} \sqrt{\frac{c_0 \hbar}{G}} \quad (4.21)$$

$$q = \pm \frac{1}{\sqrt{137,0359}} \sqrt{4\pi\epsilon_0 \hbar c_0} \quad (4.22)$$

In relation (4.22), we notice the fine structure constant:

$$\frac{1}{\alpha} = 137,0359 \quad (4.23)$$

From relation (4.23), it results that the origin of the fine structure constant is inside the internal structure of the space Planck quanta.

## CONCLUSIONS

- *The Planck mass has an algebraic sign  $\pm$  ;*
- *Each mass component is formed of a corpuscular component and a field component;*
- *The electrical charge is a quantity derived from the corpuscular mass Planck quanta;*
- *The fine structure constant has its origin inside the internal structure of the space Planck quanta.*

## 5. THE MASS OF THE ELEMENTARY PARTICLES

### 5.1. The geometric dimensions of the elementary particles

Let us consider a local perturbation in a point in space. Due to this perturbation, the equilibrium between the components of the space Planck quantum is modified.

A quantum of mass-space-time (we will call it shortly 'space'), positive or negative is expelled. Space's homogeneity and isotropy imposes to consider a sphere of  $r_0$  radius. Inside this sphere, the number of positive space quanta is with one smaller than the number of negative space quanta. From the electric point of view, the interior of the sphere is charged with a negative charge, meanwhile the exterior is charged with a positive one. **The exterior space of the sphere is then, positively charged.** The existence of an extra space quantum outside the sphere will lead to the deforming of the pre-existent Euclidian space. In this way, sphere's surrounding space deforms accordingly to the elasticity theory, **so it is in fact a Riemann space with spherical symmetry.** An expelled space Planck quantum has an additional mass, corresponding to the electrical charge  $q$  :

$$\Delta m_{pl} = \frac{1}{2} \frac{q^2}{4\pi\epsilon_0 r_{pl} c_0^2} \quad (5.1)$$

Based on formulas (4.22), (4.3) and (4.4), it results that:

$$\Delta m_{pl} = \frac{m_{pl}}{137} \quad (5.2)$$

The new expelled Planck mass becomes:

$$m'_{pl} = m_{pl} \left( 1 + \frac{1}{137} \right) \quad (5.3)$$

Corresponding to relation (5.3), Planck radius becomes:

$$r'_{pl} = \frac{r_{pl}}{1 + \frac{1}{137}} \quad (5.4)$$

Analogously relation (4.21) becomes:

$$m'_{cs} = \frac{1 + \frac{1}{139,0359}}{\sqrt{137,0359}} \sqrt{\frac{c_0 \hbar}{G}} \quad (5.5)$$

The expulsion of the space Planck quantum of mass  $m'_{cs}$ , relation (5.5) is done starting from the Planck dimension,  $r'_{pl}$ , relation (5.4), to the radius  $r_0$ .

In Riemann space, a Newtonian force,  $F_N$ , is exerted on mass  $m'_{cs}$  [11]:

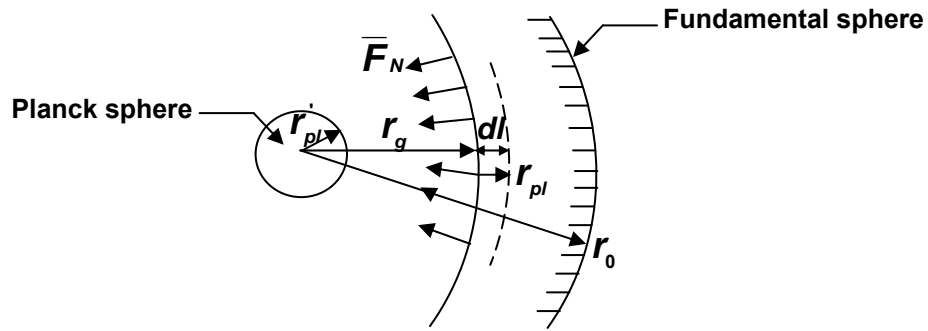
$$F_N = \frac{Gm'^2_{cs}}{r^2 \left( 1 - \frac{r'_{pl}}{r} \right)} \quad (5.6)$$

The energetic balance corresponding to the expulsion of the Planck space quantum is:

$$m'_{cs} c_0^2 = \frac{1}{4} \int_{r'_{pl}}^{r_0} \frac{Gm'^2_{cs}}{r^2 \left( 1 - \frac{r'_{pl}}{r} \right)} dl \quad (5.7)$$

The variable  $r$  is defined until a distance  $r_{pl}$  from the sphere, fig.5.1. Accordingly to fig. 5.1, we have the relations:

$$\begin{cases} r = r_g + r_{pl} \\ dl = dr = dr_g \end{cases} \quad (5.8)$$



**Figure 5.1. The calculation of the fundamental sphere's radius**

Based on relations (5.8), relation (5.7) becomes:

$$c_0^2 = \frac{Gm'_{cs}}{4} \left( -\frac{1}{r_0} + \frac{1}{r_{pl}} + \frac{1}{r'_{pl}} \ln \frac{r_0}{r'_{pl}} \right) \quad (5.9)$$

If we neglect  $\frac{1}{r_0}$  in comparison to  $\frac{1}{r'_{pl}}$ , we obtain:

$$c_0^2 = \frac{1}{4} \frac{Gm'_{cs}}{r'_{pl}} \left( 1 + \ln \frac{r_0}{r'_{pl}} \right) \quad (5.10)$$

Based on relations (5.4) and (5.5), from above mentioned relation, we obtain in the end:

$$r_0 = r_{pl} \left( 1 - \frac{1}{137} \right) e^{\frac{4\sqrt{137}-1}{1+\frac{1}{137}}} \quad (5.11)$$

The numerical value for relation (5.11) is:

$$r_0 \cong 0,91 \cdot 10^{-15} \text{ m} \quad (5.12)$$

We will call **fundamental sphere**, the sphere of radius  $r_0$ .



Relation (5.11), respectively (5.12) show that the *elementary particles can not be considered punctiform*.

### 5.1.1. Poisson coefficient

Going back to chapter 3, we can determine the value for Poisson's equation, relation (3.19), having as a starting point Planck dimension  $r_{pl}$ , given by relation (4.4) and the radius of the fundamental sphere  $r_0$  (relations (5.11) and (5.12)).

Knowing that the geometrical dimensions are multiples of Planck lengths, we define the linear deformation  $\varepsilon_l$  and the volume deformation  $\varepsilon_v$ , like this:

$$\begin{cases} \varepsilon_l = \frac{r_{pl}}{2r_0} \\ \varepsilon_v = \frac{r_{pl}^3}{(2r_0)^3} \end{cases} \quad (5.13)$$

Between linear deformation  $\varepsilon_l$  and volume deformation  $\varepsilon_v$ , there is the relation [5]:

$$\varepsilon_l = \frac{1}{(1-2\sigma)} \varepsilon_v \quad (5.14)$$

Going back to relation (3.19) and taking in consideration relations (5.13), we obtain the expression for the velocity of the longitudinal wave in vacuum:

$$c_{0l} \cong c_{0t} \frac{2r_0}{r_{pl}} \quad (5.15)$$

We substitute the numerical values for the quantities  $r_{pl}/r_0$ , from relation (5.11) and it results that the value of the longitudinal wave's velocity in vacuum is  $1,14 \cdot 10^{20}$  times higher than the transversal wave's velocity, which is  $c_{0l} = 3,22 \cdot 10^{28}$  m/s.

This prediction could explain the experimental results performed by A. Aspect in order to determine the local or non-local character of the quantum mechanics [1]. We will return to relation (5.15) in chapter 13.

From relation (5.15) and Schwarzschild metric, it results that ***the velocity of the longitudinal waves inside the fundamental sphere is equal to the velocity of the transversal waves, in comparison with the reference system of the laboratory (Euclidian space)***. Due to the fact that Poisson coefficient varies between 0 and  $\frac{1}{2}$ , it results that the velocity of the longitudinal waves  $\mathbf{c}_{0l}$  is higher

than the velocity of the transversal waves, in any situation,  $\mathbf{c}_{0l} > \mathbf{c}_{0t} \sqrt{\frac{4}{3}}$ .

## 5.2. The mass of the charged hyperions

The fundamental sphere of radius  $r_0$ , which defines the existence of the elementary particles, is the place where two energetic processes take place, one inside the sphere and another one outside the sphere.

### 5.2.1. The internal energetic process

The remained space-time Planck quanta inside the sphere can have oscillations on different frequencies. The pulsation of the standing waves inside a sphere of radius  $r_0$ , is given by relation [16]:

$$\omega(j, l) = \frac{\mathbf{c}_0 \mu_{l+\frac{1}{2}}^j}{r_0} \quad (5.16)$$

where  $\mu_{l+\frac{1}{2}}^j$  are the roots of the Bessel function  $\mathbf{J}_{l+\frac{1}{2}}$ .

The mass  $\mathbf{m}_{l+\frac{1}{2}}$ , corresponding to different oscillation modes, is obtained from relation:

$$m_{l+\frac{1}{2}}^j = \frac{\hbar\omega(j,l)}{c_0^2} = \frac{\hbar\mu_{l+\frac{1}{2}}^j}{c_0 r_0} \quad (5.17)$$

We report the mass of the elementary particles, from above mentioned relation, to the mass of the electron, relation (6.14) and we obtain:

$$m_{l+\frac{1}{2}}^{j*} = 3 \cdot 137 \cdot \mu_{l+\frac{1}{2}}^j$$

We can create Tabel 5.1. based on different values for the roots of the Bessel function  $J_{l+\frac{1}{2}}$ .

**Table 5.1. The values of the calculated and measured masses of barions**

<i>The particle</i>	$p^+$	$\Sigma^{\pm}$	$E^{\pm}$	$\Omega^{\pm}$
<i>Roots' values</i>	$\mu_{\frac{3}{2}}^1 = 4,493$	$\mu_{\frac{5}{2}}^1 = 5,763$	$\mu_{\frac{1}{2}}^2 = 6,283$	$\mu_{\frac{3}{2}}^2 = 7,72$
<i>Calculated mass in <math>m_e</math></i>	$m_p^* = 1848,6$	$m_{\Sigma}^* = 2367,36$	$m_{\Xi}^* = 2582,3$	$m_{\Omega}^* = 3172,9$
<i>Measured mass in <math>m_e</math></i>	$m_p^* = 1836,9$	$m_{\Sigma}^* = 2334$	$m_{\Xi}^* = 2587,7$	$m_{\Omega}^* = 3278$
<i>Error</i>	$\varepsilon = 0,53\%$	$\varepsilon = 1,42\%$	$\varepsilon = -0,2\%$	$\varepsilon = -0,32\%$

The measured values were taken from [12].

The series of the elementary particles is superior limited by the maximum value of the Planck quantum's oscillation. The limit oscillation of Planck quantum is given by Planck time:

$$\omega_{\text{lim}} = \frac{2\pi}{t_{Pl}}$$

The limit energy of the particle is:

$$E_{\text{lim}} = \hbar \omega_{\text{lim}} = 2\pi \frac{\hbar}{t_{pl}}$$

We insert the expression for Planck time, relation (4.5) and we obtain:

$$E_{\text{lim}} = 4\pi m_{pl} c_0^2$$

The above relation shows that the serie of the elementary particles' mass is superior limited by the Planck mass itself.

### 5.2.2. The mass of the charged meson $\pi^\pm$ and of the charged lepton $\mu^\pm$

There are two physical phenomena that should be taken into account, when calculating the mass of the meson  $\pi^\pm$  and of lepton  $\mu^\pm$ :

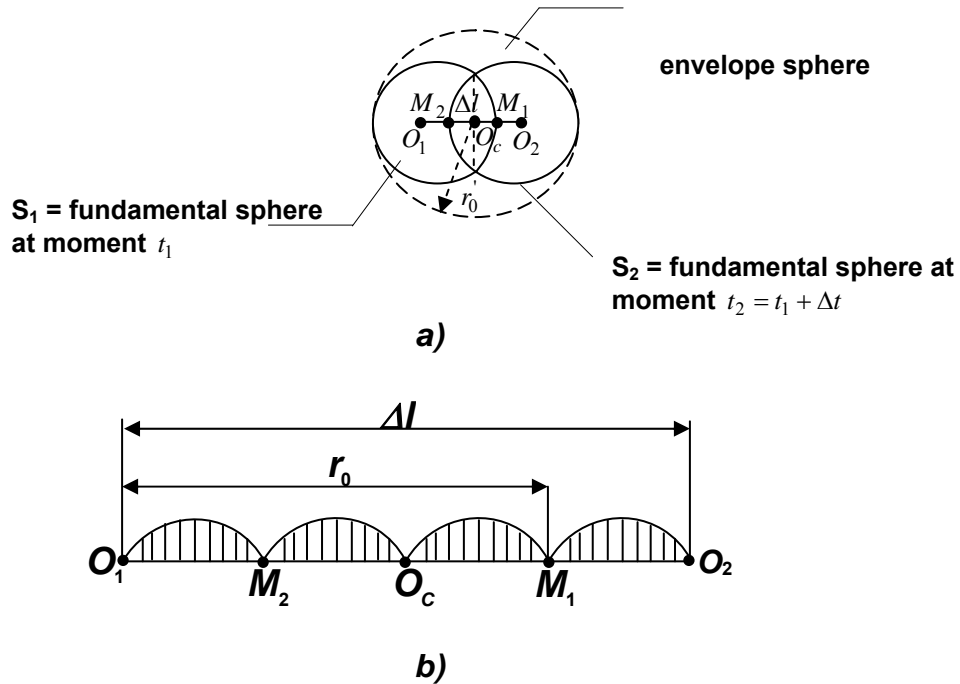
- the oscillation of the space-time Planck quanta inside the fundamental sphere, relation (5.16),
- the exterior oscillation of the fundamental sphere of mass  $m$ , obtained from the Heisenberg's uncertainty relations:
- 

$$\omega_{\text{ext}} = \frac{2\pi}{T} \tag{5.18}$$

where the period  $T$  is an uncertainty function of time  $\Delta t$ .

$$\Delta t = \frac{\hbar}{mc_0^2} \tag{5.19}$$

The fundamental sphere of radius  $r_0$  is moving with  $\Delta l$ , corresponding to the uncertainty  $\Delta l$ , as illustrated in Figure 5.2.a.



**Fig. 5.2. The calculation of the mass of the meson and the lepton**

- a) **The spatial position of the fundamental spheres at two successive moments of time**
- b) **The diagram of the standing waves in the envelope sphere**

### 5.2.3. Deducing the oscillation conditions for the mesons $\pi^\pm$ and leptons $\mu^\pm$

Let us consider the centres of the fundamental spheres,  $O_1$  and  $O_2$ , at the moment of time  $t_1$ , respectively at the moment  $t_2 = t_1 + \Delta t$ .

The displacement  $\Delta l$  is  $O_1O_2$ . We mark with  $M_1$  and  $M_2$ , the intersection of the sphere  $S_1$ , respectively of the sphere  $S_2$ , with the axes of the centres  $O_1O_2$ .

Standing oscillations of the space-time Planck quanta take place inside the fundamental sphere.

The magnitude of the oscillations has to be zero in  $O_1$ ,  $O_2$  and  $M_1$  for the sphere, at the moment  $t_1$  respectively in  $M_2$ ,  $O_c$  and  $O_2$  at the moment  $t_2$ , Figure 5.2.b. This condition is necessary in order for the oscillations of Planck quanta from

spheres  $S_1$ ,  $S_2$  and the envelope sphere (of radius  $r'_0 = r_0 + \frac{\Delta l}{2}$  and centre  $O_c$ ) to

satisfy Bessel's function  $J_{\frac{1}{2}}\left(\frac{\omega}{c}r\right)$  at any moment of time.

Knowing that the roots of the function  $J_{\frac{1}{2}}$  are equidistant:  $0, \pi, 2\pi, \dots$ , it results that we need to have:

$$O_1M_2 = M_2O_c = O_cM_1 = M_1O_2 = \frac{\Delta l}{4} \quad (5.20)$$

From Figure 5.2.b. and relation (5.20), we obtain:

$$\begin{cases} \Delta l = \frac{4}{3}r_0 \\ r'_0 = \frac{5}{3}r_0 \end{cases} \quad (5.21)$$

In order for the energy defined by the Planck quanta's oscillations to be minimum, it is necessary that the order of the function's roots  $J_{\frac{1}{2}}$ , which verifies the conditions imposed, to be minimum. One can see that we must have:

$$\begin{cases} O_1 \equiv M_2 \\ O_2 \equiv M_1 \end{cases} \quad (5.22)$$

or:

$$M_1 \equiv M_2 \quad (5.23)$$

From condition (5.22), it results:

$$\Delta l = r_0 \quad (5.24)$$

And from condition (5.23), it results:

$$\Delta l = 2r_0 \quad (5.25)$$

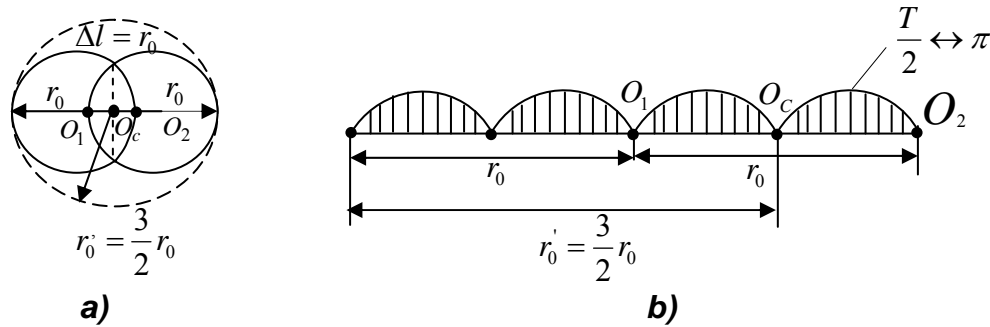
meaning that the spheres are tangent.

**5.2.3.1. The calculation of the meson's  $\pi^\pm$  mass**

For:

a)  $\Delta l = r_0$

The position of the fundamental spheres at the moments of time  $t_1$  and  $t_2 = t_1 + \Delta t$ , is presented in Figure 5.3.



**Fig.5.3. The calculation of the meson's  $\pi^\pm$  mass**

**a) The position of the fundamental spheres**

**b) The standing wave diagram**

The necessary time  $\Delta t$  for all the Planck quanta, from the sphere of radius  $r'_0$ , to get moving, is (fig.5.3.b).

$$\Delta t = 3 \frac{T}{2} \tag{5.26}$$

From relations (5.18) and (5.26), we obtain:

$$\omega_{ext} = \frac{3\pi}{\Delta t}$$

By substituting relation (5.19) in the above mentioned relation, it results:

$$\omega_{ext} = \frac{3\pi m_\pi c_0^2}{\hbar} \tag{5.27}$$

Accordingly to Figure 5.3.b., the oscillation of the Planck quanta inside the fundamental sphere of radius  $r_0$  is:

$$\omega_{Pl} = \frac{2\pi c_0}{r_0} \tag{5.28}$$

From the condition that the oscillations (5.27) and (5.28) to be equal, it results the meson's  $\pi^\pm$  mass:

$$m_\pi = \hbar \frac{2}{3c_0 r_0} \tag{5.29}$$

We refer the meson's mass from (5.29) to the electron's mass, from relation (6.14) and we obtain:

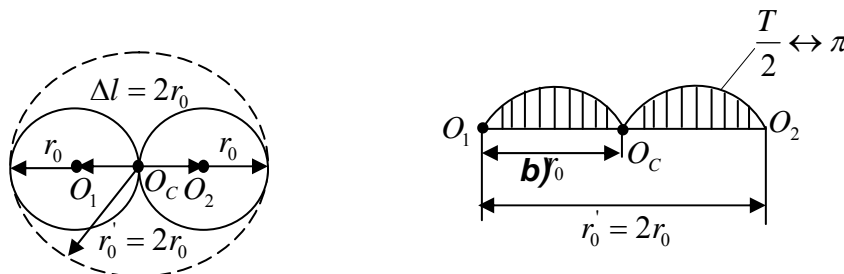
$$m_\pi^* = 2 \cdot 137 = 274 \tag{5.30}$$

### 5.2.3.2. The calculation of the lepton's $\mu^\pm$ mass

For:

b)  $\Delta l = 2r_0$

The position of the fundamental spheres, at the moments of time  $t_1$  and  $t_2 = t_1 + \Delta t$  is presented in Figure 5.4.a:



**Figure 5.4. The calculation of the lepton's  $\mu^\pm$  mass**

**a) The position of the fundamental spheres**

**b) The standing wave diagram**



By applying the same reasoning as in the previous case, we obtain:

$$\Delta t = 2 \frac{T}{2} \quad (5.31)$$

From relations (5.18), (5.19) and (5.31) we obtain:

$$\omega_{\text{ext}} = \frac{2\pi m_{\mu} c_0^2}{\hbar} \quad (5.32)$$

Accordingly to Figure 5.4.b, the oscillation of the Planck quanta inside the sphere of radius  $r_0$ , is:

$$\omega_{\text{pl}} = \pi \frac{c_0}{r_0} \quad (5.33)$$

From relations (5.32) and (5.33) we obtain the lepton's  $\mu^{\pm}$  mass:

$$m_{\mu} = \frac{\hbar}{2c_0 r_0} \quad (5.34)$$

We refer the lepton's mass-relation (5.34), to the electron's mass - relation (6.14) and we obtain:

$$m_{\mu}^* = \frac{3}{2} \cdot 137 = 205.5$$

The obtained results are synthesized in the table below. The measured data were taken from [11].

Table 5.2. The values of the calculated masses for the mesons and leptons

The particle	$\pi^\pm$	$\mu^\pm$
The root	$\frac{\mu_1^2}{2} = 2\pi$	$\frac{\mu_1^2}{2} = 2\pi$
The equivalent radius	$\Delta l = r_0$	$\Delta l = 2r_0$
Calculated mass in $m_e$	$m_\pi^* = 274$	$m_\mu^* = 205,27$
Measured mass in $m_e$	$m_\pi^* = 273,2$	$m_\mu^* = 206,77$
Error	$\varepsilon = 0,292\%$	$\varepsilon = -0,725\%$

### 5.3. The relativistic transformation of the internal mass

The internal mass of the hadrons and mesons is based on the space Planck quanta's standing oscillations of a certain frequency, inside the fundamental sphere.

If in a certain reference system, a wave is a standing one of angular frequency  $\omega_0$ , and then this wave, which is observed in a reference system that moves with the velocity  $\mathbf{v}_0$  referred to the first one, appears like a pulsation wave [2]:

$$\omega = \frac{\omega_0}{\sqrt{1 - \frac{v_0^2}{c_0^2}}} \quad (5.35)$$

The corresponding mass is:

$$m_{\text{int}} = \frac{\hbar \omega_0}{c_0^2 \sqrt{1 - \frac{v_0^2}{c_0^2}}} \quad (5.36)$$

Where, accordingly to relation (5.16), we have:

$$\omega_0 = \frac{c_0 \mu_{1+\frac{1}{2}}^j}{r_0} \quad (5.37)$$

From relations (5.36), (5.37) and (5.17), it results the transformation formula for the internal mass referred to the mobile reference system:

$$m_{\text{int}} = \frac{m_0}{\sqrt{1 - \frac{v_0^2}{c_0^2}}} \quad (5.38)$$

## 5.4. The external energetic process

### 5.4.1. The electron's mass in its own reference system

The electron is an elementary particle without internal energy, meaning  $\omega_{\text{int}} = \mathbf{0}$ , which corresponds to  $\mu_{1+\frac{1}{2}}^j = \mathbf{0}$ .

The external energy is stored as electric field, in the outside Riemann space.

From the electric point of view, we can consider the space outside the fundamental sphere as being Euclidian, space in which the relative electric permittivity and relative magnetic permeability are functions of the distance  $r$  [11], respectively relation (3.23):

$$\varepsilon_r(r) = \frac{1}{\sqrt{g_{00}}} \quad \mu_r(r) = \frac{1}{\sqrt{g_{00}}} \quad (5.39)$$

where:

$$g_{00} = 1 - \frac{r_0}{r}$$

meanwhile  $r_0$  is the radius of the fundamental sphere.

The electric field  $\bar{\mathbf{E}}$  and the electric polarization of space  $\bar{\mathbf{P}}$  have the expressions:

$$\bar{E} = \frac{q}{4\pi\epsilon_0} \sqrt{g_{00}} \nabla \left( \frac{1}{r} \right) \quad (5.40)$$

$$\bar{P} = \frac{q}{4\pi} (1 - \sqrt{g_{00}}) \nabla \left( \frac{1}{r} \right) \quad (5.41)$$

The electric charge density corresponding to the polarization of space can be obtained from:

$$\text{div} \bar{P} = -\rho_{pol}$$

and has the expression:

$$\rho_{pol} = -\frac{q}{8\pi} \frac{r_0}{r^4 \sqrt{g_{00}}} \quad (5.42)$$

By integrating relation (5.42) on the whole exterior volume of the electron, we obtain the electric charge of polarization:

$$q_{pol} = -q \quad (5.43)$$

And we find again the electric charge's value of the expelled space quantum.

The energy accumulated in the exterior field is:

$$W = \frac{1}{2} \int \bar{E} (\epsilon_0 \bar{E} + \bar{P}) dv \quad (5.44)$$

We substitute relations (5.40) and (5.41) in (5.44) and we obtain the final energy in the end:

$$W = \frac{1}{3} \frac{q^2}{4\pi\epsilon_0 r_0} = m_{el} c_0^2 \quad (5.45)$$

From where we have the electron's mass:

$$m_{el} = \frac{1}{3} \frac{q^2}{4\pi\epsilon_0 r_0 c_0^2} \quad (5.46)$$

#### 5.4.2. The electron's mass in uniform and rectilinear relativist motion

The density of the electromagnetic moment for an electron in uniform rectilinear motion with the velocity  $\mathbf{v}_0$  is:

$$\bar{\mathbf{g}} = \epsilon_0 \bar{\mathbf{E}} \times \bar{\mathbf{B}} \quad (5.47)$$

where the magnetic induction  $\bar{\mathbf{B}}$  has the expression (11.10) or [6]

$$\bar{\mathbf{B}} = \frac{\bar{\mathbf{v}}_0 \times \bar{\mathbf{E}}}{c_0^2} \quad (5.48)$$

For an observer situated at distance  $r$  from the electrical charge, which forms an angle  $\theta$  with the movement direction, the  $\mathbf{Ox}$  component of the density of the electromagnetic moment is obtained utilizing relations (5.47) and (5.48):

$$g_x = \frac{\epsilon_0 v_0}{c_0^2} E^2 \sin\theta \quad (5.49)$$

We replace the expression of  $\bar{\mathbf{E}}$  from (5.40) and we obtain, after integrating relation (5.49) on the entire exterior volume of the electron, the expression of the total electromagnetic impulse along the axe  $\mathbf{Ox}$  :

$$\mathbf{p} = \frac{1}{3} \frac{q^2}{4\pi\epsilon_0 r_0 c_0^2} \mathbf{v} \quad (5.50)$$

The electromagnetic mass represents the velocity's coefficient from the above relation:

$$m_{emag} = \frac{1}{3} \frac{q^2}{4\pi\epsilon_0 r_0 c_0^2} \quad (5.51)$$

One can observe that the electromagnetic mass, expressed using relation (5.51) and the electrical mass, expressed using relation (5.46) are identical.

### 5.4.3. Relativistic transformation of the electron's mass

The external energy of the fundamental sphere (the electron) is after all of elastic nature. The density of elastic energy is notated with  $\varepsilon$  and is numerically equal to the density of electric energy:

$$\varepsilon = \frac{\overline{ED}}{2} \quad (5.52)$$

In the above mentioned relation  $\overline{E}$  has the expression from (5.40).

The above physical quantities are considered in the electron's reference system.

We approach the problem of the electron's mass from the elasticity tensor's point of view. In these conditions, the tensor  $T^{ik}$  has the form [11]

$$T^{ik} = \begin{pmatrix} \varepsilon & 0 & 0 & 0 \\ 0 & 0 & 0 & 0 \\ 0 & 0 & 0 & 0 \\ 0 & 0 & 0 & 0 \end{pmatrix} \quad (5.53)$$

The relativistic transformation of the tensor (5.53) leads to the expression of the density of energy  $\varepsilon_e$  and of the density of energy flux  $S$  [11], referred to the reference system of the laboratory:

$$\mathcal{E}_e = \frac{\mathcal{E}}{1 - \frac{v_0^2}{c_0^2}} \quad (5.54)$$

$$\mathbf{S} = \frac{\mathcal{E} \mathbf{v}_0}{1 - \frac{v_0^2}{c_0^2}} \quad (5.55)$$

We integrate the above relations on the whole exterior space of the electron (the fundamental sphere) and we take into account relation (5.52). We obtain, in the end, the expression of the energy and impulse in the reference system of the laboratory:

$$W_{el} = \frac{1}{3} \frac{q^2}{4\pi\epsilon_0 r_0 c_0^2} \frac{1}{\sqrt{1 - \frac{v_0^2}{c_0^2}}} = \frac{m_{el} c_0^2}{\sqrt{1 - \frac{v_0^2}{c_0^2}}} \quad (5.56)$$

$$\mathbf{G}_x = \frac{\mathbf{S}}{c_0^2} = \frac{1}{3} \frac{q^2}{4\pi\epsilon_0 r_0 c_0^2} \frac{v_0}{\sqrt{1 - \frac{v_0^2}{c_0^2}}} = \frac{m_{el}}{\sqrt{1 - \frac{v_0^2}{c_0^2}}} \mathbf{v}_0 \quad (5.57)$$

From relations (5.56) and (5.57), we notice that the electron's mass transforms relativistically as the internal mass, given by relation (5.38).

### 5.5. Heisenberg's uncertainty relations

In order to determine Heisenberg's uncertainty relations, we will begin from the following arguments:

1) The radius of the fundamental sphere  $r_0$  has been calculated from energy reasons, paragraph 5.1.

2) The measurement of the impulse and energy of an elementary particle is done by utilizing some physical phenomena which also imply energy phenomena. In other words, the measurement process implies the variation of the physical properties of the vacuum and by default the variation of the radius of the fundamental sphere  $r_0$ .

We will analyse the phenomenon of measurement for:

A) *the mass of internal nature* :

Let consider two states of the same:

- In the first state, due to the measurement devices, the fundamental sphere's radius is  $r_1$  and correspondingly, we obtain the mass of internal nature:

$$m_{\text{int1}} = \frac{\hbar \mu_{l+\frac{1}{2}}^j}{c_0 r_1} \quad (5.58)$$

- In the second state, the radius of the fundamental sphere is  $r_2$  and correspondingly, we obtain:

$$m_{\text{int2}} = \frac{\hbar \mu_{l+\frac{1}{2}}^j}{c_0 r_2} \quad (5.59)$$

The difference of mass obtained after the measuring process is obtained from relations (5.58) and (5.59):

$$\Delta m_{\text{int}} = m_{\text{int2}} - m_{\text{int1}} = \frac{\hbar \mu_{l+\frac{1}{2}}^j}{c_0} \frac{r_1 - r_2}{r_1 r_2} \quad (5.60)$$

We define the impulse corresponding to the mass difference  $\Delta m$ :

$$\Delta p_{\text{int}} = \Delta m_{\text{int}} \mathbf{v} = \hbar \mu_{l+\frac{1}{2}}^j \frac{r_1 - r_2}{r_1 r_2} \frac{\mathbf{v}}{c_0} \quad (5.61)$$



We can rewrite relation (5.61) such as:

$$\Delta p_{\text{int}} \frac{c_0}{v} \frac{r_1 r_2}{(r_1 - r_2) \mu_{l+\frac{1}{2}}^j} = \hbar \quad (5.62)$$

One can observe that the fraction from the left has length dimension, meaning that:

$$\Delta l = \frac{r_1 r_2}{(r_1 - r_2) \mu_{l+\frac{1}{2}}^j} \frac{c_0}{v} \quad (5.63)$$

From relations (5.62) and (5.63) we obtain:

$$\Delta p_{\text{int}} \Delta l = \hbar \quad (5.64)$$

Relation (5.64) is formally identical with Heisenberg's uncertainty relation.

### B ) mass of external nature

We will rationalize identically as in the previous case, only that we will use as calculation formulas the ones in (5.46), from which results (6.14):

$$m_{\text{ext}1} = \frac{1}{3 \cdot 137} \frac{\hbar}{c_0 r_1} \quad (5.65)$$

$$m_{\text{ext}2} = \frac{1}{3 \cdot 137} \frac{\hbar}{c_0 r_2} \quad (5.66)$$

The mass difference is:

$$\Delta m_{\text{ext}} = \frac{1}{3 \cdot 137} \frac{\hbar}{c_0} \frac{r_1 - r_2}{r_1 r_2} \quad (5.67)$$

We define the impulse analogously:

$$\Delta p_{ext} = \frac{1}{3 \cdot 137} \hbar \frac{r_1 - r_2}{r_1 r_2} \frac{v}{c_0} \quad (5.68)$$

From relation (5.68), we obtain:

$$\Delta p_{ext} \Delta l = \hbar \quad (5.69)$$

In which:

$$\Delta l = 3 \cdot 137 \frac{r_1 r_2}{r_1 - r_2} \frac{c_0}{v}$$

Relation (5.69) shows that we can also obtain a relation identical with Heidenberg'd uncertainty relation for the case of the mass of external nature.

### C) total mass

The total mass for the first measurement is obtained from relations (5.58) and (5.65):

$$m_{total,1} = \frac{\hbar}{c_0 r_1} \left( \mu_{l+\frac{1}{2}}^j + \frac{1}{3 \cdot 137} \right) \quad (5.70)$$

Respectively, for the second measurement, from relations (5.59) and (5.66):

$$m_{total,2} = \frac{\hbar}{c_0 r_2} \left( \mu_{l+\frac{1}{2}}^j + \frac{1}{3 \cdot 137} \right) \quad (5.71)$$

From relations (5.70) and (5.71) we obtain the expression for the impulse of difference of mass:

$$\Delta p = \hbar \left( \mu_{l+\frac{1}{2}}^j + \frac{1}{3 \cdot 137} \right) \frac{r_1 - r_2}{r_1 r_2} \frac{v}{c_0} \quad (5.72)$$

From relation (5.72) we obtain:

$$\Delta p \Delta l = \hbar \quad (5.73)$$

In which:

$$\Delta l = \frac{r_1 r_2}{r_1 - r_2} \frac{1}{\mu_{l+\frac{1}{2}}^j + \frac{1}{3 \cdot 137}} \frac{c_0}{v} \quad (5.74)$$

Relation (5.73) represents Heisenberg's first uncertainty relation. For  $\Delta l = v \Delta t$  we obtain Heisenberg's second uncertainty relation:

$$\Delta E \Delta t \geq \hbar \quad (5.75)$$

The fundamental physical phenomenon that stands at the bottom of all Heisenberg's uncertainty relations is the following:

**There can not be determined simultaneously the mass and the geometrical dimensions of the elementary particle, through any measurement.**

From a mathematical point of view, the uncertainty is introduced by relation:

$$\Delta l = \frac{r_1 r_2}{r_1 - r_2} \quad (5.76)$$

At Planck level, we have the limit situation:

$$\begin{cases} r_1 = r_2 + r_{pl} \\ r_2 = r_{pl} \end{cases} \quad (5.77)$$

It results that:

$$\Delta l = 2r_{pl} \quad (5.78)$$

For  $\mathbf{v} = \mathbf{c}_0$ , relation (4.1) is rediscovered.

## CONCLUSIONS

- *The fundamental radius is expressed based on Planck dimension;*
- *The velocity of the longitudinal waves is  $c_{0l} = 3,22 \cdot 10^{28}$  m/s;*
- *The mass of the elementary particles is obtained from the energy processes that take place inside and outside the fundamental sphere;*
- *The mass of internal nature is the result of the oscillations of the standing waves from the fundamental sphere ;*
- *The mass of the electron is of external nature (elastical), meaning electromagnetical;*
- *The measurement of the exact geometrical dimensions of the elementary particles is impossible.*

## 6. GRAVITATIONAL INTERACTION

### 6.1. Gravitational interaction based on the internal mass of the particles

Let us consider two elementary particles of mass  $m_{01}$  and  $m_{02}$  situated at the distance  $r$ .

Accordingly to relation (5.17), the two internal masses are given by relations:

$$m_{01} = \frac{\hbar \mu_{l_1 + \frac{1}{2}}^{j_1}}{c_0 r_0} \quad (6.1)$$

$$m_{02} = \frac{\hbar \mu_{l_2 + \frac{1}{2}}^{j_2}}{c_0 r_0} \quad (6.2)$$

We first consider that particle **2** can be found in the deformed space by particle **1**. The velocity of light in point 2, accordingly to relation (3.23), is:

$$c_2(r) = c_0 \left[ 1 - \frac{a(m_{01})}{r} \right] \quad (6.3)$$

We have supposed that in relation (6.3), the constant of integration from relation (3.15) is a function of the mass  $m_{01}$ , meaning that  $a(m_{01}) = a_1$ .

The internal energy of particle **2**, at the distance  $r$  in the deformed space by particle **1**, is obtained from (6.2) and (6.3):

$$E_2(r) = \frac{\hbar \mu_{l_2 + \frac{1}{2}}^{j_2}}{r_0} c_0 \left[ 1 - \frac{a(m_{01})}{r} \right] \quad (6.4)$$

The force that is exerted on it equal to:

$$F_{12} = \frac{dE_2(r)}{dr} = m_{02} c_0^2 \frac{a(m_{01})}{r^2} \quad (6.5)$$

Analogously, we have:

$$F_{21} = \frac{dE_1(r)}{dr} = m_{01} c_0^2 \frac{a(m_{02})}{r^2} \quad (6.6)$$

In relation (6.5) we observe that regarding the two masses, we have used the method of separation of variables in respect to  $m_{01}$  and  $m_{02}$ . The mass  $m_{02}$  appears at the first power, meanwhile  $m_{01}$  appears in an unknown function,  $a(m_{01})$ .

In relation (6.6), the situation is reversed, meaning that  $m_{01}$  is at first power, meanwhile  $m_{02}$  appears in an unknown function  $a(m_{02})$ .

From here, we can conclude that function  $a(m)$  is a linear one, depending on the mass  $m$ :

$$\begin{cases} a(m_{01}) = km_{01} \\ a(m_{02}) = km_{02} \end{cases} \quad (6.7)$$

where  $k$  is a constant.

We return to relations (6.5) and (6.6) written using (6.7) and we obtain **Newton's law of universal attraction**:

$$\begin{cases} F_{12} = \frac{kc_0^2 m_{02} m_{01}}{r^2} = \frac{Gm_{02} m_{01}}{r^2} \\ F_{21} = \frac{kc_0^2 m_{01} m_{02}}{r^2} = \frac{Gm_{01} m_{02}}{r^2} \end{cases} \quad (6.8)$$

where:

$$G = kc_0^2 \quad (6.9)$$

We replace the constant  $k$  given by (6.9) in relations (6.7) and we obtain the general form for the function  $a(m)$ :

$$a(m) = \frac{Gm}{c_0^2} = r_g \quad (6.10)$$

In relation (6.10), we recognize the expression of the gravitational radius  $r_g$ , obtained by solving exactly Einstein's equation [5].

### 6.1.1. The gravitational interaction between two bodies of masses $m_1$ and $m_2$

Each of the two bodies is formed out of  $N_1$ , respectively  $N_2$  elementary particles:

$$\begin{cases} m_1 = N_1 m_{01} \\ m_2 = N_2 m_{02} \end{cases} \quad (6.11)$$

Based on space's linear elasticity, we can apply the superposition principle, so that each of  $N_1$  elementary particles interacts one at a time with each of the other  $N_2$  elementary particles. The resulting force is:

$$F_{N_{rez}} = \frac{GN_1 N_2 m_{01} m_{02}}{r^2} = \frac{Gm_1 m_2}{r^2} \quad (6.12)$$

In the above relation we have used relation (6.11).

## 6.2. Gravitational interaction expressed in function of the external mass $m_{ext}$

The mass of a charged elementary particle is composed of the mass corresponding to the internal energy and the mass corresponding to the external energy.

Next, we will study how interacts a mass  $m$  which deforms space, with a mass of external nature  $m_{ext}$  (electrical).

We consider an elementary particle with mass  $m_{ext}$  given by relation (5.46), situated at the distance  $r$  of a body of mass  $m$ .

The energy of external nature  $W_{ext}$  is given by the electromagnetic mass:

$$W_{ext} = \frac{1}{3} \frac{q^2}{4\pi\epsilon_0 r_0}$$

We replace  $q$  with the expression from (4.22) and we obtain:

$$W_{ext} = \frac{1}{137 \cdot 3} \cdot \frac{\hbar c_0}{r_0} \quad (6.13)$$

$$m_{ext} = \frac{W_{ext}}{c_0^2} = \frac{1}{137 \cdot 3} \cdot \frac{\hbar}{c_0 \cdot r_0} \quad (6.14)$$

At the distance  $r$  in the deformed space, the radial velocity of light is:

$$c = c_0 \left( 1 - \frac{a}{r} \right) \quad (6.15)$$

The external energy stored in the electric field is obtained from (6.13) and (6.15):

$$W_{ext} = \frac{1}{137 \cdot 3} \cdot \frac{\hbar}{r_0} c_0 \left( 1 - \frac{a}{r} \right) \quad (6.15)$$



The interaction force is:

$$F = \frac{\partial W_{\text{ext}}}{\partial r} = \frac{1}{137 \cdot 3} \frac{\hbar c_0}{r_0} \frac{a}{r^2}$$

From relations (6.10), (6.13) and (6.14) we obtain:

$$F = \frac{G m_{\text{ext}} m}{r^2} \quad (6.17)$$

Based on the superposition principle, from relations (6.8) and (6.17), we notice that in the gravitational interactions, *the mass that appears in Newton's formula is given by the sum between the mass of internal nature and the one of external nature.*

## CONCLUSIONS

- *The law of gravitational attraction is obtained from the theorem of the generalized forces applied to the energy of the whole elementary particles found in a gravitational field, of a certain metric.*

## 7. ELECTRICAL INTERACTION

### 7.1. Coulomb's law

By expelling a Planck quantum of space from the Planck sphere, of radius  $r_{pl}$ , a dislocation of all Planck quanta is produced inside it.

The density of the dislocations  $\rho(r)$  is proportional to  $\frac{1}{r^4}$  [10]:

$$\rho_{pl}(r) = \frac{\rho_0}{r^4} \quad (7.1)$$

The constant  $\rho_0$  is determined from the condition that the integral of the relation (7.1), calculated on the exterior volume of the Planck quantum should represent the corpuscular mass of the dislocated Planck quantum,  $m_{cs}$ .

$$\int_{r_{pl}}^{\infty} \frac{\rho_0}{r^4} 4\pi r^2 dr = m_{cs} \quad (7.2)$$

After calculation, we obtain the expression of the constant  $\rho_0$ :

$$\rho_0 = \frac{m_{cs} r_{pl}}{4\pi}$$

So that relation (7.1) becomes in Euclidian space:

$$\rho(r) = \frac{m_{cs} r_{pl}}{4\pi r^4} \quad (7.3)$$

The density of energy corresponding to relation (7.3) is:

$$w = \frac{m_{cs} r_{pl}}{4\pi r^4} c_0^2 \quad (7.4)$$

Accordingly to relation (6.10) at Planck scale we have the relation:

$$r_{pl} c_0^2 = G m_{cs} \quad (7.5)$$

We substitute relation (7.5) in relation (7.4) and we obtain:

$$w = \frac{G m_{cs}^2}{4\pi r^4} \quad (7.6)$$

In relation (7.6) we make the substitution:

$$G m_{cs}^2 \Rightarrow \frac{q^2}{4\pi\epsilon} \quad (7.7)$$

And we obtain the expression for the density of energy of the dislocated mass's density as a function of two new quantities: the charge  $q$  and the vacuum permittivity  $\epsilon_0$  :

$$w = \frac{q^2}{(4\pi)^2 \epsilon_0 r^4} \quad (7.8)$$

Based on the formalism above mentioned, it results the expression of the Maxwell voltage tensor:

$$w_e = \frac{1}{2} \frac{q^2}{(4\pi)^2 \epsilon_0 r^4} \quad (7.9)$$

In order to get Coulomb's formula from electrostatics, we consider two fundamental spheres of  $r_0$ .

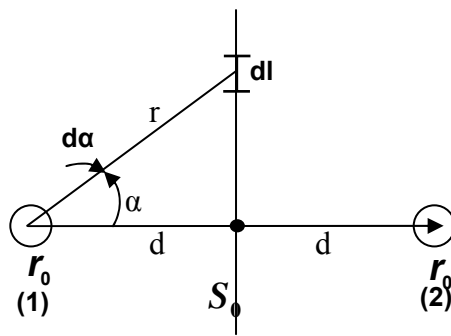
Let us consider the symmetry plan  $S_0$ , perpendicular on the longitudinal axis which connects the particles **1** and **2**. In a point belonging to the symmetry plan, characterized by the vector  $r$ , the Maxwell tensor is given by relation (7.9).

From symmetry reasons, the interaction force  $F_{12}$  between the two fundamental spheres, is obtained from integrating the voltages' tensor on the symmetry plan  $S_0$  :

$$F_{12} = \int_{S_0} w_e ds \quad (7.10)$$

in which:

$$ds = 2\pi r \sin \alpha \cdot dl$$



**Fig.7.1. Calculation of the interaction between two fundamental spheres electrically charged, situated at a distance  $2d$**

We introduce the variable change:

$$\left\{ \begin{array}{l} r = \frac{d}{\cos \alpha} \\ dl = -\frac{d}{\cos^2 \alpha} d\alpha \end{array} \right. \quad (7.11)$$

After calculation we obtain **Coulomb's formula**:

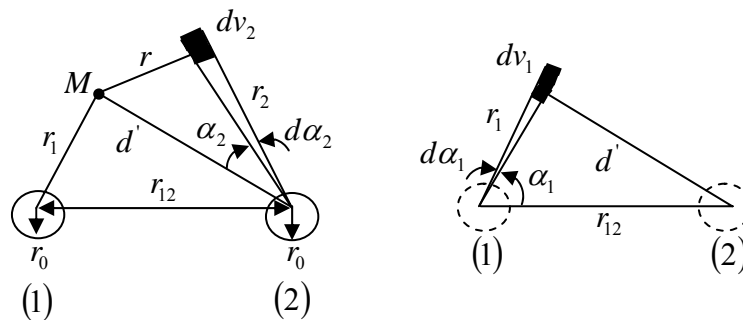
$$F_{12} = -\frac{q_1 q_2}{4\pi \epsilon_0 d_{12}^2} \quad (7.12)$$

The negative sign from the relation above is a consequence of the properties of the interaction forces between the two dislocations.

### 7.2. The interaction between the polarized electrical charges

By expelling one of the two components of the Planck quantum of space, the vacuum space surrounding the fundamental sphere gets polarized with an electrical charge of polarization.

Knowing Coluomb's formula, we propose to study if the Coulombian force is transmitted at the distance or step by step. The problem reduces to the study of the interaction between the Planck electrical charges of polarization of space with identical or different sign. Let us consider two electrical charges  $q$ , of radiuses  $r_0$ .



**Fig. 7.2. The calculation of the interaction between two polarized electrical charges**

Let  $M$  be a current point situated at the distance  $r_1$  from the particle 1-fig.7.2.

The polarized electrical charge from a volume element around point  $M$  interacts with all the polarized electrical charge, generated by the electrical charge (2). The interaction energy is:

$$dW_e = \rho(r_1)dv_1 \int \frac{\rho_2(r_2)dv_2}{r} \tag{7.13}$$

We introduce according to the figure, the volume element  $d\mathbf{v}_2$  and the distance  $r$  from the point  $\mathbf{M}$  and the volume element  $d\mathbf{v}_2$ :

$$d\mathbf{v}_2 = 2\pi r_2^2 \sin \alpha_2 dr_2 \quad (7.14)$$

$$r = \sqrt{d'^2 + r_2^2 - 2d'r_2 \cos \alpha_2} \quad (7.15)$$

From relations (7.13), (7.14) and (7.15) it results:

$$dW_e = \rho_1(r_1) d\mathbf{v}_1 \int \frac{\rho_2(r_2) 2\pi r_2^2 \sin \alpha_2 d\alpha_2 dr_2}{\sqrt{d'^2 + r_2^2 - 2d'r_2 \cos \alpha_2}} \quad (7.16)$$

It can be observed that:

$$\frac{dr}{d\alpha_2} = \frac{d'r_2 \sin \alpha_2}{\sqrt{d'^2 + r_2^2 - 2d'r_2 \cos \alpha_2}} \quad (7.17)$$

So that the relation (7.16) becomes after calculation:

$$dW_e = \frac{\rho_1(r_1) d\mathbf{v}_1}{d'} \int_{r_0}^{\infty} 4\pi \rho_2(r_2) r_2^2 dr_2 \quad (7.18)$$

We introduce the expression given by formula (5.42) in the relation (7.18) which is for the density of the polarization of space and we obtain:

$$dW_e = q \frac{\rho_1(r_1) d\mathbf{v}_1}{d'} \quad (7.19)$$

For integrating the relation (7.19), we consider the same reasoning as before:

With the notations from fig.7.2, we have:

$$d\mathbf{v}_1 = 2\pi r_1^2 \sin \alpha_1 d\alpha_1 d\mathbf{r}_1 \quad (7.20)$$

$$d' = \sqrt{r_{12}^2 + r_1^2 - 2r_{12}r_1 \cos \alpha_1} \quad (7.21)$$

We replace relations (7.20) and (7.21) in (7.19) and we obtain:

$$dW_e = q \int_{r_0}^{\infty} \int_0^{\pi} \frac{2\pi r_1 \rho_1(r_1) r_1 \sin \alpha_1 d\alpha_1}{\sqrt{r_{12}^2 + r_1^2 - 2r_{12}r_1 \cos \alpha_1}} d\mathbf{r}_1 \quad (7.22)$$

We observe that:

$$\frac{dd'}{d\alpha_1} = \frac{r_{12}r_1 \sin \alpha_1}{\sqrt{r_{12}^2 + r_1^2 - 2r_{12}r_1 \cos \alpha_1}} \quad (7.23)$$

From relations (7.22) and (7.23), we have:

$$W_e = 4\pi q \int_{r_0}^{\infty} \frac{r_1^2 \rho_1(r_1)}{r_{12}} d\mathbf{r}_1 \quad (7.24)$$

We introduce expression (5.42) for the density of the polarized electrical charge of space  $\rho_{pol}$ . After calculation, we obtain:

$$W_e = \frac{1}{4\pi\epsilon_0} \frac{q^2}{r_{12}} \quad (7.25)$$

The interaction force between the polarized electrical charges is obtained by deriving the energy, (7.25) in report to  $r_{12}$ :

$$F_c = \frac{dW_e}{dr_{12}} = -\frac{q^2}{4\pi\epsilon_0 r_{12}^2} \quad (7.26)$$

Relation (7.26) shows that the Coulombian interaction force between to electrical charges is made “**step by step**” **through the polarization electrical charges**.

In order to determine the Coulombian interaction between an electrical charge  $Q_1$ , made of  $N_1$  elementary charges and an electrical charge  $Q_2$  made of  $N_2$  elementary charges, it is applied the reasoning from the paragraph 6.2.taking into account that:

$$Q_1 = N_1 q$$

Respectively that:

$$Q_2 = N_2 q$$

We obtain:

$$F_c = -\frac{1}{4\pi\epsilon_0} \frac{N_1 N_2 q^2}{r^2} = -\frac{Q_1 Q_2}{4\pi\epsilon_0 r^2} \quad (7.27)$$

Relation (7.27.) represents **Coulomb's formula for two electrical charges**.



## CONCLUSIONS

- *Coulomb's law is a consequence of the elastic interactions generated by the dislocation of the corpuscular component of the Planck mass quantum, in the exterior of the sphere;*
- *The "electrical" interactions take place through the polarized electrical charge of space;*
- *The electrical charges of opposite sign attracts each other, meanwhile the electrical charges of the same sign repel, accordingly to the interaction between two dislocations.*

## 8. THE INERTIAL AND GRAVITATIONAL MASS

### 8.1. The inertial and gravitational mass of internal nature

At the bottom of general relativity theory stand two fundamental principles:

1. The equivalence principle.
2. The covariance principle.

The equivalence principle states that: “in a domain (space) of small extend (local space), the homogenous and uniform gravitational field is equivalent under the aspect of its actions, to an accelerating field (the field of the inertial forces”. In this principle, there is reflected the equality between the inertial mass  $m_i$  and the heavy, gravitational mass  $m_g$  of a material body [4]:

$$m_i = m_g \quad (8.1)$$

The gravitational mass of internal nature  $m_{int,g}$  can be obtained from the Newton's formula of the universal attraction:

$$F_N = m_{int} \cdot g = m_{int,g} \cdot g \quad (8.2)$$

Where  $g$  represents the field of the gravitational accelerations generated by a body of mass  $m$  :

$$g = \frac{Gm}{r^2} \quad (8.3)$$

### 8.1.1. The inertial and gravitational mass of internal nature in the space of Euclidian metric

#### 8.1.1.1. Uniform motion

In order to obtain the expression of the inertial mass of internal nature  $m_{int,i}$ , we will consider as a starting point the expression for the energy of internal nature, in the laboratory's reference system:

$$E_{int} = \frac{\hbar\omega_0}{\sqrt{1 - \frac{v^2}{c^2}}} \quad (8.4)$$

In which the angular frequency  $\omega_0$  is given by relation (5.37).

The relativistic transformation of the angular frequency  $\omega$  into uniform motion with the constant acceleration  $\mathbf{a}$  can be obtained starting from the relations of transformation of the speed ( $v$ ) and space ( $x$ ), [13]:

$$\left\{ \begin{array}{l} \mathbf{v}(\mathbf{a}, t) = \frac{\mathbf{a}t}{\sqrt{1 + \left(\frac{\mathbf{a}t}{c_0}\right)^2}} \\ \mathbf{x}(\mathbf{a}, t) = \frac{c_0^2}{\mathbf{a}} \left[ \sqrt{1 + \left(\frac{\mathbf{a}t}{c_0}\right)^2} - 1 \right] \end{array} \right. \quad (8.5)$$

By eliminating the time from relations (8.5), we get to the expression of space, as a function of speed and acceleration.

$$\mathbf{x} = \frac{c_0^2}{\mathbf{a}} \left[ \sqrt{\frac{c_0^2}{c_0^2 - v^2} - 1} \right] \quad (8.6)$$

We rewrite relation (8.6) in an equivalent form as follows:

$$\frac{1}{\sqrt{1 - \frac{v^2}{c_0^2}}} = 1 + \frac{a}{c_0^2} x \quad (8.7)$$

From relations (8.4) and (8.7) we obtain the expression of the internal energy:

$$E_{\text{int}}(\mathbf{x}) = \hbar \omega_0 \left( 1 + \frac{a}{c_0^2} x \right) = m_{\text{int}} c_0^2 \left( 1 + \frac{a}{c_0^2} x \right) \quad (8.8)$$

The inertial force  $F_{in}$  is obtained from the previous relation:

$$F_{in} = \frac{dE_{\text{int}}}{dx} = m_{\text{int}} a = m_{\text{int}.i} a \quad (8.9)$$

Relation (8.9) (the magnitude), represents **Newton's second law for the mass of internal nature in uniform motion**. The expression of the internal energy in a gravitational field is obtained from the metric given by relation (3.25) or [11]:

$$E_{\text{int},g} = \hbar \omega_g = \frac{\hbar \omega_0}{\sqrt{1 - \frac{r_g}{r}}} \quad (8.10)$$

The Euclidian space can be approximated with gravitational fields of weak intensity ( $r \gg r_g$ ). We expand the square root and we consider the expression of the gravitational radius ( $r_g = \frac{2GM}{c_0^2}$ ).

After calculation, we obtain:

$$\omega_g = \omega_0 \left( 1 + \frac{GM}{c_0^2 r} \right) \quad (8.11)$$

From relations (8.10) and (8.11) it results that:

$$E_{\text{int},g} = m_{\text{int}} c_0^2 \left( 1 + \frac{GM}{c_0^2 r} \right) \quad (8.12)$$

The gravitational force can be obtained from the theorem of the generalized forces and the following formula results:

$$F_g = - \frac{dE_{\text{int},g}}{dr} = \frac{GMm_{\text{int}}}{r^2} = m_{\text{int}} g = m_{\text{int},g} g \quad (8.13)$$

By comparing relations (8.9) and (8.13) we deduce that:

$$m_{\text{int},i} = m_{\text{int},g} \quad (8.14)$$

### 8.1.1.2. Circular motion

In the circular motion, the angular velocity  $\omega$  transforms relativistically with respect to the tangential motion- relation (8.4), as well as with respect to the position in the gravitational field- relation (8.10).

Taking into account the two transformations, the expression of the internal energy becomes:

$$E_{\text{int},\text{cir}} = \frac{\hbar \omega_0}{\sqrt{1 - \frac{v_t^2}{c_0^2}}} \cdot \frac{1}{\sqrt{1 - \frac{r_g}{r}}} \quad (8.15)$$

For  $v_t \ll c_0$  and gravitational fields of weak intensity,  $r \gg r_g$ , relation (8.15) becomes:

$$E_{\text{int,cir}} \approx \hbar\omega_0 \left(1 + \frac{1}{2} \frac{v_t^2}{c_0^2}\right) \left(1 + \frac{1}{2} \frac{r_g}{r}\right) \quad (8.16)$$

If we neglect the infinite small terms of order two:

$$\frac{v_t^2}{c_0^2} \frac{r_g}{r}$$

Relation (8.16) becomes:

$$E_{\text{int,cir}} \approx \hbar\omega_0 \left(1 + \frac{1}{2} \frac{v_t^2}{c_0^2} + \frac{1}{2} \frac{r_g}{r}\right) \quad (8.17)$$

The inertial and gravitational forces can be obtained from relation (8.17) and have the following expressions:

$$\mathbf{F}_{\text{int,cir}} = \frac{d}{dt} \left( \frac{d}{dv_t} E_{\text{int,cir}} \right) = \frac{\hbar\omega_0}{c_0^2} \mathbf{a}_t = m_{\text{int},i} \mathbf{a}_t \quad (8.18)$$

$$\mathbf{F}_{g,\text{cir}} = -\frac{d}{dr} E_{\text{int,cir}} = \frac{\hbar\omega_0}{2} \frac{r_g}{r^2} = m_{\text{int},g} \mathbf{g} \quad (8.19)$$

By comparing relations (8.18) and (8.19), we deduce that for the circular motion we also have:

$$m_{\text{int},i} = m_{\text{int},g} \quad (8.20)$$

### 8.1.2. The inertial and gravitational mass of internal nature in the space of Schwarzschild metric

#### 8.1.2.1. Radial motion

Let us consider an elementary particle that moves radial, accelerated. The inertial force is obtained from relation (8.4). The radial velocity is a function of  $r$  and  $t$ .

We derive the internal energy as a composed function and we obtain the inertial force:

$$F_{in} = \frac{dE_{int}}{dr} = \frac{dE_{int}}{dv_r} \frac{dv_r}{dt} \frac{dt}{dr} \quad (8.21)$$

Knowing that:

$$\frac{dv_r}{dt} = a_r$$

and

$$\frac{dt}{dr} = \frac{1}{v_r}$$

From relations (8.4) and (8.21) it results that:

$$F_{in} = \frac{\hbar \omega_0 a_r}{c_0^2 \sqrt{\left(1 - \frac{v_r^2}{c_0^2}\right)^3}} = \frac{m_{int,i} a_r}{\sqrt{\left(1 - \frac{v_r^2}{c_0^2}\right)^3}} \quad (8.22)$$

For the gravitational force, we will use relation (8.10). By derivation with respect to the radius  $r$ , we obtain:

$$F_g = \frac{\hbar \omega_0 r_g}{r^2 \sqrt{\left(1 - \frac{r_g}{r}\right)^3}} = \frac{GMm_{\text{int}}}{r^2 \sqrt{\left(1 - \frac{r_g}{r}\right)^3}} = \frac{gm_{\text{int},g}}{\sqrt{\left(1 - \frac{r_g}{r}\right)^3}} \quad (8.23)$$

As shown in chapter 6 -relation (6.10), the general relations are valuable:

$$\begin{cases} r_g = \frac{Gm}{c_0^2} \\ r = \frac{Gm}{v^2} \end{cases}$$

Which lead to:

$$1 - \frac{v^2}{c_0^2} = 1 - \frac{r_g}{r} \quad (8.24)$$

By comparing relation (8.22) with (8.23), in which (8.24) is projected on the radius  $r$ , it results:

$$m_{\text{int},i} = m_{\text{int},g} \quad (8.25)$$

### 8.1.2.2. Circular motion

The inertial and gravitational forces are obtained from relation (8.15) without making the approximations from relations (8.16) and (8.17).

$$F_{\text{in},\text{cir}} = \frac{d}{dt} \left( \frac{d}{dv_t} E_{\text{int},\text{cir}} \right) = \frac{m_{\text{int},i} a_t}{\sqrt{\left(1 - \frac{v_t^2}{c_0^2}\right)^3}} \frac{1}{\sqrt{1 - \frac{r_g}{r}}} \quad (8.26)$$

$$F_{g,\text{cir}} = -\frac{d}{dr} E_{\text{int},\text{cir}} = \frac{m_{\text{int},g} g}{\sqrt{1 - \frac{v_t^2}{c_0^2}}} \frac{1}{\sqrt{\left(1 - \frac{r_g}{r}\right)^3}} \quad (8.27)$$



Based on relation (8.24) from (8.26) and (8.27) it results that in the circular movement as well:

$$m_{\text{int}.i} = m_{\text{int}.g} \quad (8.28)$$

## 8.2. The inertial and gravitational mass of external nature (electrical)

### 8.2.1. The inertial and gravitational mass of external nature in the space of Euclidian metric

#### 8.2.1.1. Uniform motion

Let us consider a particle with an electrical charge  $q$ . Its mass of external nature (electrical), in its own reference system, has the expression:

$$m_e = \frac{1}{3} \frac{q^2}{4\pi\epsilon_0 r_0 c_0^2} \quad (8.29)$$

The relativistic transformation of the energy of external nature is made accordingly to the relation (5.53).

$$W_{el} = \frac{1}{3} \frac{q^2}{4\pi\epsilon_0 r_0 c_0^2} \frac{1}{\sqrt{1 - \frac{v^2}{c_0^2}}} = \frac{m_{el} c_0^2}{\sqrt{1 - \frac{v^2}{c_0^2}}} \quad (8.30)$$

Based on relation (8.7), relation (8.30) becomes:

$$W_{el} = m_{el} c_0^2 \left( 1 + \frac{a}{c_0^2} x \right) \quad (8.31)$$

The inertial force is obtained from the previous relation:

$$F_{in} = \frac{dW_{el}}{dx} = m_{el} a = m_{el,i} a \quad (8.32)$$

Relation (8.32) (the magnitude), represents **Newton's second law for the mass of external nature (electrical) in uniform motion**. The electrical energy in gravitational field is obtained from relations (8.30) and (8.24):

$$W_{el,g} = \frac{m_{el} c_0^2}{\sqrt{1 - \frac{r_g}{r}}} \approx m_{el} c_0^2 \left( 1 + \frac{GM}{c_0^2} \frac{1}{r} \right) \quad (8.33)$$

The gravitational force is obtained from the theorem of the generalized forces. It results the expression:

$$F_g = -\frac{dW_{el,g}}{dr} = \frac{GMm_{el}}{r^2} = m_{el} g = m_{el,g} g \quad (8.34)$$

By comparing relations (8.32) and (8.34) we deduce that:

$$m_{el,i} = m_{el,g} \quad (8.35)$$

### 8.2.1.2. Circular motion

In the circular motion, the mass transforms relativistically with respect to the tangential motion- relation (8.4), as well as with respect to the position in the gravitational field.

Taking into account the two transformations, the expression of the external energy (electrical) becomes:

$$W_{el,cir} = \frac{m_{el} c_0^2}{\sqrt{1 - \frac{v_t^2}{c_0^2}}} \cdot \frac{1}{\sqrt{1 - \frac{r_g}{r}}} \quad (8.36)$$

In the above relation it has been considered the expression of the speed of light after the tangential direction:  $c_{0t} = c_0 \sqrt{1 - \frac{r_g}{r}}$ , which is obtained from the metrics of the space (3.25) for the coordinates  $r$  and  $\varphi$  constant.

For  $v_t \ll c_0$  and gravitational fields of weak intensity,  $r \gg r_g$ , relation (8.36) becomes:

$$W_{el,cir} \approx m_{el} c_0^2 \left( 1 + \frac{1}{2} \frac{v_t^2}{c_0^2} \right) \left( 1 + \frac{1}{2} \frac{r_g}{r} \right) \quad (8.37)$$

We neglect the infinite small terms of order two, having the form:  $\frac{v_t^2}{c_0^2} \frac{r_g}{r}$

Relation (8.37) becomes:

$$W_{el,cir} \approx m_{el} c_0^2 \left( 1 + \frac{1}{2} \frac{v_t^2}{c_0^2} + \frac{1}{2} \frac{r_g}{r} \right) \quad (8.38)$$

The inertial force and the gravitational one are obtained from relation (8.38) and have the form:

$$F_{in,cir} = \frac{d}{dt} \left( \frac{d}{dv_t} W_{el,cir} \right) = m_{el} a_t = m_{el,i} a_t \quad (8.39)$$

$$F_{g,cir} = - \frac{d}{dr} W_{el,cir} = \frac{m_{el} c_0^2}{2} \frac{r_g}{r^2} = m_{el,g} g \quad (8.40)$$

By comparing relations (8.39) and (8.40), we deduce that for the circular motion, as well, we have:

$$m_{el,i} = m_{el,g} \quad (8.41)$$

## 8.2.2. The inertial and gravitational mass of external nature in the space of Schwarzschild metric

### 8.2.2.1. Radial motion

Let us consider an electrical charge that moves accelerated, after a radial direction. The inertial force is obtained from relation (8.4). The radial velocity is a function of  $r$  and  $t$ .

We derive the external energy (electric al) as a composed function, relation (8.21) and we obtain the inertial force:

$$F_{in} = \frac{m_{el,i} a}{\sqrt{\left(1 - \frac{v^2}{c_0^2}\right)^3}} \quad (8.42)$$

From relations (8.24) and (8.30) it results that:

$$W_{el} = \frac{m_{el} c_0^2}{\sqrt{1 - \frac{r_g}{r}}} \quad (8.43)$$

The gravitational force is obtained from (8.43):

$$F_g = \frac{dW_{el}}{dr} = \frac{GMm_{el}}{r^2 \sqrt{\left(1 - \frac{r_g}{r}\right)^3}} = m_{el} \frac{g_0}{\sqrt{\left(1 - \frac{r_g}{r}\right)^3}} = m_{el,g} \frac{g_0}{\sqrt{\left(1 - \frac{r_g}{r}\right)^3}} \quad (8.44)$$

By comparing relations (8.42) and (8.44), it results:

$$m_{el,i} = m_{el,g} \quad (8.45)$$

## 8.2.2.2. Circular motion

The inertial and gravitational forces are obtained from relation (8.36) without making the approximations specific to the Euclidian space:

$$F_{in,cir} = \frac{d}{dt} \left( \frac{d}{dv_t} W_{el,cir} \right) = \frac{m_{el,i} a_t}{\sqrt{\left(1 - \frac{v_t^2}{c_0^2}\right)^3}} \frac{1}{\sqrt{1 - \frac{r_g}{r}}} \quad (8.46)$$

$$F_{g,cir} = - \frac{dW_{el,cir}}{dr} = \frac{m_{el,g} g}{\sqrt{1 - \frac{v_t^2}{c_0^2}}} \frac{1}{\sqrt{\left(1 - \frac{r_g}{r}\right)^3}} \quad (8.47)$$

Based on the relation (8.24) from (8.46) and (8.47) it results the circular motion:

$$m_{el,i} = m_{el,g} \quad (8.48)$$

The total inertial and gravitational mass is obtained from relations (8.45) and (8.48):

$$m_{totala,i} = m_{int,i} + m_{el,i} = m_{int,g} + m_{el,g} = m_{totala,g} \quad (8.49)$$

Relation (8.49) represents “***the equality between the inertial mass and the gravitational mass, meaning Einstein’s Postulate which stands at the bottom of the General Theory of Relativity***”:

$$m_i = m_g \quad (8.50)$$

## **CONCLUSIONS**

- *The inertial mass and the gravitational one are equal in both the uniform and circular motion.*
- *The equality between the inertial mass and the gravitational one is demonstrated based on the formula for the calculation of the internal and external mass of the elementary particles, of the kinetical transformations from the Special Theory of Relativity and General Theory of Relativity and of the theorem of the generalized forces.*

## 9. STRONG INTERACTION

### 9.1. Nuclear interaction

The interactions known as “gravitational interaction” and “electrical interaction” have been demonstrated for the distance  $r$  between the particles much longer than the radius of the fundamental sphere  $r_0$ .

For the distance  $r$  comparable to the radius of the fundamental sphere  $r_0$ , new physical phenomena will appear which will be explained using quantum mechanics. For start, we will consider as known the principles of the quantum mechanics. They will be demonstrated in chapter 10.

We have seen in chapter 5.3. that the random motion of the meson  $\pi$  leads to the obtaining of the internal mass, relation (5.30).

We propose to calculate based on quantum mechanics, the masses that can be obtained if the meson  $\pi$  is moving randomly in a sphere of radius  $r_\pi = \frac{3}{2}r_0$ .

The equation of movement for the meson is given by relation (10.49):

$$-\frac{\hbar}{2m_\pi} \left( \nabla^2 - \frac{1}{c_0^2} \frac{\partial^2}{\partial t^2} \right) \Psi = 2i\hbar \frac{\partial \Psi}{\partial t} + m_\pi c_0^2 \Psi \quad (9.1)$$

We are looking for a solution of the following form:

$$\Psi(\mathbf{x}, \mathbf{y}, \mathbf{z}) e^{i\frac{E}{\hbar}t} \quad (9.2)$$

Where  $E$  represents the energy of the meson outside the sphere of radius  $r_\pi$ .

From relations (9.1) and (9.2), we obtain the equation:

$$\nabla^2 \Psi = - \left( \frac{E + m_\pi c_0^2}{\hbar c_0} \right)^2 \Psi \quad (9.3)$$

We impose that  $\psi(\mathbf{x}, \mathbf{y}, \mathbf{z})$  to be zero on the surface of the sphere of radius

$$r_\pi = \frac{3}{2} r_0:$$

$$\Psi|_{S_{r_\pi}} = 0 \quad (9.4)$$

The eigenfunctions and eigenvalues of the problem at the limit (9.3) and (9.4), are expressed by relation [16]:

$$\Psi_{ljm} = \frac{C_{ljm}}{\sqrt{r}} J_{l+\frac{1}{2}}\left(\mu_{l+\frac{1}{2}}^j \frac{r}{r_\pi}\right) Y_l^m(\theta, \varphi) \quad (9.5)$$

where  $\mu_{l+\frac{1}{2}}^j$  are the positive roots of the Bessel function of semi-integer index  $J_{l+\frac{1}{2}}$ ,

respectively  $Y_l^m(\theta, \varphi)$  are the spherical functions.

From relations (9.3), (9.4) and (9.5), it is obtained:

$$\frac{E + m_\pi c_0^2}{\hbar c_0} = \frac{\mu_{l+\frac{1}{2}}^j}{r_\pi} \quad (9.6)$$

Based on relation  $r_\pi = \frac{\hbar}{m_\pi c_0}$  and of relation (9.6) the mass of the elementary

particles is obtained as a function of the meson's  $\pi$  mass. We have:

$$m = m_\pi \left( \mu_{l+\frac{1}{2}}^j - 1 \right)$$

In the previous relation we relate the two masses  $m$  and  $m_\pi$  to the mass of the electron and it results:

$$m^* = m_\pi^* \left( \mu_{l+\frac{1}{2}}^j - 1 \right) \quad (9.7)$$



In Table 9.1 there are presented the masses of some elementary particles as a function of the related mass of the meson  $\pi$ ,  $m_\pi^*$ , and the roots of the Bessel function  $J_{l+\frac{1}{2}}$ .

**Table 9.1. The values of the calculated and measured masses of some elementary particles as a function of the related mass of the meson  $\pi$ ,  $m_\pi^*$ , and the roots of the Bessel function  $J_{l+\frac{1}{2}}$**

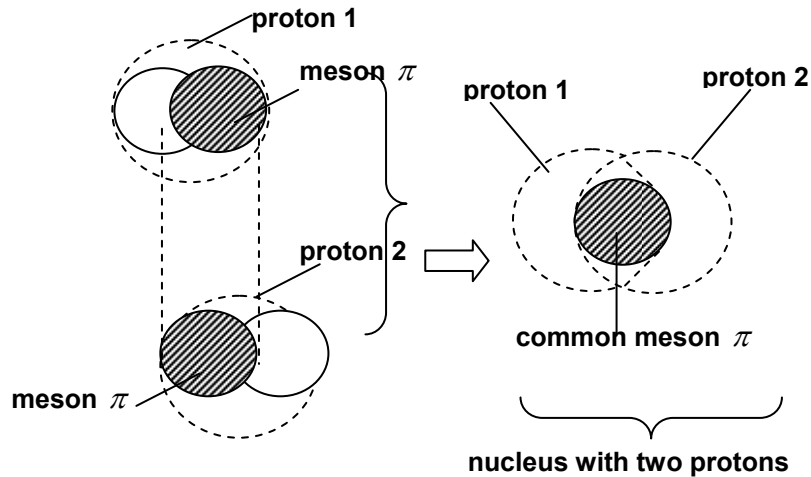
The particle	$k^\pm$	$p^\pm$	$\Sigma^\pm$	$\Xi^\pm$
The root	$\mu_{\frac{3}{2}}^1 = 4,493$	$\mu_{\frac{3}{2}}^2 = 7,725$	$\mu_{\frac{1}{2}}^3 = 9,42$	$\mu_{\frac{7}{2}}^2 = 10,417$
Calculated mass in $m_e$	954,28	1837,27	2307,08	2572,72
Measured mass in $m_e$	966,3	1836,9	2327,6	2587,7
Error	$\varepsilon = 1,25\%$	$\varepsilon = 0,02\%$	$\varepsilon = 0,85\%$	$\varepsilon = 0,58\%$

The physical phenomenon of the interaction between two baryons takes place in the following manner:

We consider two protons  $p_1$  and  $p_2$ , for example, described by two mesons  $\pi$ , like in Figure 9.1.

By the joining of the two protons, these put in common a meson and the result is a nucleus made of two protons. The common  $\pi$  meson describes the mass of the proton 1 as well as the mass of the proton 2.

The common meson  $\pi$  "changed" by the two protons, form *the strong interaction force*. The action radius is equal to  $\frac{3}{2}r_0$  and has the approximate value of  $1,4 \cdot 10^{-15}$  m.



**Fig.9.1. The schematic representation of the interaction between two protons inside the atomic nucleus**

## 9.2. The magnetic momentum and the mechanical momentum of the elementary particles

### 9.2.1. The exterior mechanical momentum

At the very bottom of the hole theory of unification stands the space-time Planck quantum.

***By expelling a space-time Planck quantum, not only the mass of the quantum is eliminated, but also all its other properties such as: magnetic momentum and mechanical one.***

The mechanical momentum is given by the expression:

$$\mathbf{S}_{PI} = m_{PI} \mathbf{r}_{PI} \mathbf{c}_0 = \frac{\hbar}{2} \quad (9.8)$$

Based on the conservation law of the kinetic momentum, the spine of the space Planck quantum is transmitted to an elementary particle  $\mathbf{x}$  of mass  $m_x$  and radius  $r_0$  or  $r_x$  :

$$\frac{\hbar}{2} = m_x r_x v_x \quad (9.9)$$

Let us consider that the external magnetic momentum  $\mu_{xext}$  of the same particle is given by relation:

$$\mu_{xext} = q v_x r_x \quad (9.10)$$

In order to eliminate the problems concerning the dimension of the speed  $v_x$ , we eliminate the speed  $v_x$  from relations (9.9) and (9.10), and we obtain:

$$\mu_{xext} = \frac{\hbar}{2} \frac{q}{m_x} \quad (9.11)$$

We take as a standard the magnetic momentum of the electron:

$$\mu_{el} = \frac{\hbar}{2} \frac{q}{m_{el}} = M_B \quad (9.12)$$

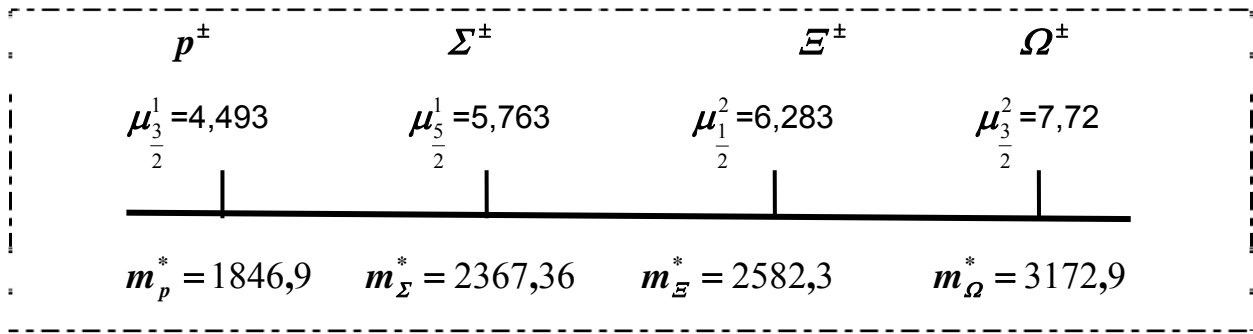
From relations (9.11) and (9.12) we obtain the relation proposed by Pauli [12]:

$$\mu_{xext} = \mu_{el} \frac{m_{el}}{m_x} = M_B \frac{m_{el}}{m_x} \quad (9.13)$$

## 9.2.2. The disintegration of the electrically charged hyperions

### 9.2.2.1. The disintegration of the hyperions $\Sigma^\pm$ , $E^\pm$ , $\Omega^\pm$

Let us arrange the values of the masses together with the corresponding roots of the Bessel function from Table 5.1. in a growing order on the axis. We will obtain the diagram below, figure 9.2:



**Fig. 9.2. The mass of the baryons related to the electrons' mass, as a function of the Bessel function's roots**

The following table results corresponding to the diagram in fig. 9.2:

**Table 9.2. Some values for the roots of the Bessel function  $J_{l+1/2}$  and the mass of the corresponding baryons, as a function of  $l$  and  $j$**

	$j = 1$ $(\mu_{l+1/2}^1)$	$j = 2$ $(\mu_{l+1/2}^2)$	$j = 3$ $(\mu_{l+1/2}^3)$	.... $\infty$
$l = 0$ $(J_{1/2})$		$\Sigma^\pm$ $\mu_{1/2}^2 = 6,28$ $m_\Sigma^* = 2582,3$	$\Delta_4$ $\mu_{1/2}^3 = 9,42$ $m_{\Delta_4}^* = 3871,62$	...
$l = 1$ $(J_{3/2})$	$p^\pm$ $\mu_{3/2}^1 = 4,493$ $m_p^* = 1846,9$	$\Omega^\pm$ $\mu_{3/2}^2 = 7,72$ $m_\Omega^* = 3172,9$		...
$l = 2$ $(J_{5/2})$	$\Sigma^\pm$ $\mu_{5/2}^1 = 5,763$ $m_\Sigma^* = 2367,36$	$\Delta_5^\pm$ $\mu_{5/2}^2 = 9,045$ $m_{\Delta_5}^* = 3717,495$		...
.....	.....	.....	.....	.....
$\vdots$ $\infty$				

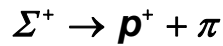
From the example above, it results that the baryons can be presented in a table similar to the one of the chemical elements, made by Mendeleev.

Let us consider the disintegration reaction for the hyperion  $\Sigma^\pm$  [12]; underneath we write the conservation laws:



- The electrical charge  $\mathbf{q}$ ,  $+1 \rightarrow +1 + 0$  is conserved;
- The baryon charge  $\mathbf{B}$ ,  $+1 \rightarrow +1 + 0$  is conserved;
- The strangeness  $\mathbf{S}$ ,  $-1 \rightarrow 0 + 0$  is not conserved;
- The hypercharge  $\mathbf{Y}$ ,  $0 \rightarrow 1 + 0$  is not conserved.

Let us rewrite the same disintegration reaction underneath which we write the corresponding Bessel function's roots:



$$\mu_{\frac{5}{2}}^1 \rightarrow \mu_{\frac{3}{2}}^1 \quad (9.15)$$

We observe that the number of the root, meaning  $\mathbf{1}$  is conserved, meanwhile the index of the Bessel function decreases from  $\mathbf{5/2}$  to  $\mathbf{3/2}$ , meaning that it decreases with  $\mathbf{1}$ .

Let us also consider the disintegration reaction of the hyperion  $\Omega^-$ ; underneath we write the conservation laws:



- The electrical charge  $\mathbf{q}$ ,  $-1 \rightarrow -1 + 0$  is conserved;
- The baryon charge  $\mathbf{B}$ ,  $+1 \rightarrow -1 + 0$  is conserved;
- The strangeness  $\mathbf{S}$ ,  $-3 \rightarrow -2 + 0$  is not conserved;
- The hypercharge  $\mathbf{Y}$ ,  $-2 \rightarrow -3 + 0$  is not conserved.

Let us rewrite the same disintegration reaction (9.16) underneath which we write the corresponding Bessel function's roots:

$$\Omega^- \rightarrow \Xi^- + \pi^0$$

$$\mu_{\frac{3}{2}}^2 \rightarrow \mu_{\frac{1}{2}}^2$$

We observe that the number of the root **1** is conserved, meanwhile the index of the Bessel function decreases from **3/2** to **1/2**, meaning that it decreases with **1**.

In order to draw a final conclusion, we introduce the notion of energetical level of the fundamental sphere of radius  $r_0$  in the following manner: for a given Bessel function, the first root represents the first energetic level; the second root represents the second energetic level and so on.

The law of the disintegration of the electrically charged hyperions is the following:

“A hyperion disintegrates in another hyperion through:

- The conservation of the electrical charge;
- The conservation of the energetical level;
- The decrease with **1** of the index of the Bessel function associated with the “energetic” level.”

Based on this law we can explain why the hyperion  $\Xi^\pm$  can't decompose into another hyperion  $\Sigma^\pm$ .

Let us write the reaction together with the laws of conservation:

$$\Xi^- \rightarrow \Sigma^- + \text{neuter meson} \quad (9.17)$$

- The electrical charge  $q$ ,  $-1 \rightarrow -1$  is conserved;
- The baryon charge  $B$ ,  $+1 \rightarrow +1$  is conserved;
- The strangeness  $S$ ,  $-2 \rightarrow -1$  is not conserved;
- The hypercharge  $Y$ ,  $-1 \rightarrow 0$  is not conserved.

We compare the disintegration reaction of the hyperion  $\Xi^+$  with the disintegration reactions of the hyperions  $\Sigma^+$  and  $\Omega^-$ , relations (9.14) and (9.16).

We notice that this kind of reaction could take place, but experiences show us differently. The conservation laws can not explain such an anomalie.

Let us write the disintegration reaction for the hyperion  $\Xi^-$ , underneath which we write the corresponding Bessel function's roots:

$$\begin{aligned} \Xi^- &\rightarrow \Sigma^- \\ \mu_{\frac{1}{2}}^2 &\rightarrow \mu_{\frac{5}{2}}^1 \end{aligned} \tag{9.18}$$

From the above reaction, we observe that the particle which disintegrates ( $\Xi^-$ ) is on the **second** energetic level, meanwhile the particle in which it should disintegrate has the **first** energetic level.

This fact is against the stated law: it does not keep the energetic level. The index of the Bessel function corresponding to the hyperion in which it disintegrates, should decrease with **1**, and not increase with **2**. In conclusion, such a reaction can not take place.

The obtained results are synthesized in table 9.3.

**Table 9.3 The scheme of the disintegration of the hyperions  $\Sigma^\pm, \Xi^\pm, \Omega^\pm$**

	$j = 1$ $(\mu_{l+\frac{1}{2}}^1)$	$j = 2$ $(\mu_{l+\frac{1}{2}}^2)$
$l = 0$ $(J_{\frac{1}{2}})$		$\Xi^\pm$ $\mu_{\frac{1}{2}}^2 = 6,28$ $m = 0$ $m_\Xi^* = 2582,3$
$l = 1$ $(J_{\frac{3}{2}})$	$\rho^\pm$ $\mu_{\frac{3}{2}}^1 = 4,493$ $m = 0, \pm 1$ $m_p^* = 1846,9$	$\uparrow$ $\Omega^\pm$ $\mu_{\frac{3}{2}}^2 = 7,72$ $m = 0, \pm 1$ $m_\Omega^* = 3172,9$
$l = 2$ $(J_{\frac{5}{2}})$	$\uparrow$ $\Sigma^\pm$ $\mu_{\frac{5}{2}}^1 = 5,763$ $m = 0, \pm 1, \pm 2$ $m_\Sigma^* = 2367,36$	

## CONCLUSIONS

- *The internal mass of the elementary particles can be calculated as a function of the meson's mass ;*
- *The nuclear interaction between the protons results as a consequence of the simultaneous description of their mass through one common meson;*
- *The kinetic momentum and the magnetic one of an elementary particle is a consequence of the conservation law of the mechanical and magnetic moment of a Planck quantum of mass, expelled from the fundamental sphere.*
- *The disintegration reactions of the electrically charged hyperions take place after the following laws:*
  - *the electrical charge is conserved.*
  - *the energetic level is conserved;*
  - *the index of the Bessel function which is associated with the energetic level decreases with 1.*



## 10. QUANTUM MECHANICS

### 10.1. The fundamental theorems of the quantum mechanics

The following theorems are the synthesis of the ones presented in the previous chapters.

**T.1.** Any elementary particle is space-time singularity or a composition of space-time singularities, surrounded by a curved space of a certain metric.

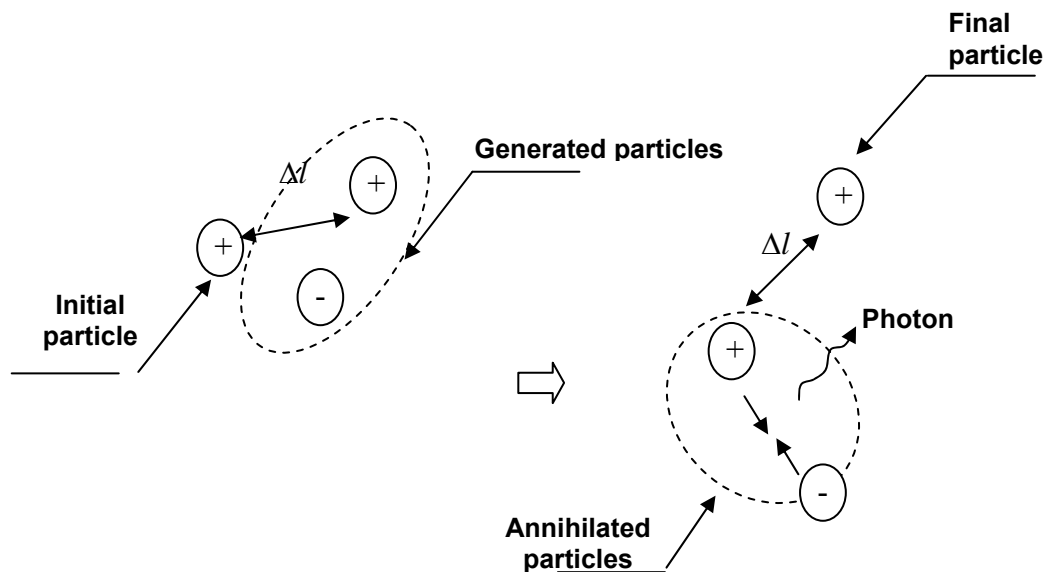
**T.2.** Any perturbation is propagating in vacuum as a wave with the velocity  $c_0$ .

**T.3.** The necessary energy for deforming the vacuum space, in a period, is represented by Planck's constant–  $h$ , so, the energy in  $\nu$  periods in the time unit is  $h\nu$ .

**T.4.** The energetical deformations of the vacuum are superiorly limited by the existence of a wavelength/critical frequency, at which appear irreversible deformations that lead to the appearance of the corpuscle.

In this context, the corpuscle represents the “solidified” space for a certain short interval of time.

**T.5.** In the curved space that accompanies any particle, at a certain moment, takes birth at a certain distance at it a particle and an anti-particle.



**Fig 10.1. The generation-annihilation mechanism of the elementary particles**

The initial particle annihilates with the anti-particle in the presence of the newly created particle and emits a quantum of energy. The resulting quantum of energy will generate a new pair particle-anti-particle in the curved space of the previously created particle and feed-back mechanism will repeat infinitely, fig 10.1.

## 10.2. The measuring problem in quantum mechanics

In the reference literature, there are described in detail the devices used in the technique of measurements in quantum mechanics.

Let us take as an example the problem of diffraction of corpuscles through multiple slots. Based on theorem T.5., in any moment the corpuscle is governed by the generation-annihilation phenomenon, so it has a random motion and the curved space that surrounds it, has an undulatory movement, accordingly to theorem T.1.

The wave created in this manner is diffracted by the slot, leading to the well-known interference phenomena.

In the points where the energy of the wave that has been obtained as a consequence of the interference overreaches the critical energy of “solidifying” of space, re-appears the corpuscle accordingly to theorem T.4. The physical phenomenon acts as if the “**wave would guide**” the corpuscle. [2].

In the case where the corpuscles are illuminated by a beam, similar physical phenomena appear: the incident waves of light will interfere with the waves that accompany the corpuscle, leading again to the same kind of physical phenomena as previously described.

In conclusion, any process of measurement at quantum level, is itself “**a generator of physical phenomena**” (*diffraction, interference*), so that the ideal measurement does not exist.

### 10.3. Schrödinger's equation for spin-less particles

#### 10.3.1. Schrödinger's operator

Accordingly to theorem T.5., a particle has a random motion. Let us consider at a certain moment, that the particle is found in the origin of the coordinate system. The probability density of finding the particle at the distance  $r$ , after  $n$  cycles of generation-annihilation is given by relation [14]:

$$\rho(r, n) = \frac{1}{[\sqrt{2\pi n}(\Delta l)^2]^3} \cdot \exp\left(-\frac{r^2}{2n(\Delta l)^2}\right) \quad (10.1)$$

where  $\Delta l$  represents the step with which the particle moves after each cycle of generation-annihilation.

Let  $\Delta t$  be the necessary time of a generation-annihilation cycle in which the  $\Delta l$  shifting in space is produced. We define the shifting speed of the particle:

$$v = \frac{\Delta l}{\Delta t} \quad (10.2)$$

Based on relation:

$$mv\Delta l = \hbar$$

And of relation (10.2), we obtain:

$$\Delta l^2 = \frac{\hbar}{m} \Delta t$$

We recalculate expression (10.1) by using the result obtained above and we have:

$$\rho(r, n) = \frac{1}{[\sqrt{2\pi n \Delta t}]^3} \exp\left(-\frac{r^2}{2 \frac{\hbar}{m} n \Delta t}\right) \quad (10.3)$$

Let us consider that **the unity of measurement of time is equal to the time interval  $\Delta t$  in which a cycle takes place**, so that  $n\Delta t$  represents the elapsed time from the initial moment. Relation (10.3) becomes:

$$\rho(r, t) = \frac{1}{\left[\sqrt{2\pi \frac{\hbar}{m} t}\right]^3} \exp\left(-\frac{r^2}{2 \frac{\hbar}{m} t}\right) \quad (10.4)$$

The expression (10.4) represents the fundamental solutions of the operator [16]:

$$\frac{\hbar}{2m} \nabla^2 = \frac{\partial}{\partial t} \quad (10.5)$$

**The operator (10.5) should express in the same time the propagation of the waves that result due to the particle-antiparticle annihilation process**

The angular frequency of these waves is:

$$\omega_{g,0} = \frac{2mc^2}{\hbar} \quad (10.6)$$

It is obvious that the operator (10.5) should contain a correction factor **A**:

$$\frac{\hbar}{2m} \nabla^2 = \mathbf{A} \frac{\partial}{\partial t} \quad (10.7)$$

The correction factor **A** is determined from the condition that the equation of the emitted spherical waves

$$\frac{1}{r} \exp\left[-i\omega\left(t - \frac{r}{c}\right)\right]$$

Should verify relation (10.7).

Through calculus we obtain  $\mathbf{A} = -i$ , so that the operator becomes:

$$-\frac{\hbar}{2m} \nabla^2 = i \frac{\partial}{\partial t} \quad (10.8)$$

Relation (10.8) represents *Schrodinger's operator*.

### 10.3.2. Schrödinger's equation for a particle placed in a field of force of potential energy $E_p$

#### 10.3.2.1. The potential energy $E_p(\mathbf{x}, \mathbf{y}, \mathbf{z})$ is invariant in time

In the domain where the electron stands, there are two types of oscillations of space, generated by:

a) the generation-annihilation phenomenon that has the angular frequency:

$$\omega_{g.a.} = \frac{2mc^2}{\hbar}$$

b) the potential energy  $E_p(\mathbf{x}, \mathbf{y}, \mathbf{z})$  that has the angular frequency:

$$\omega_p = \frac{E_p}{\hbar} \quad (10.9)$$

It is obvious that interference between the two oscillations exists. The density of probability that in an interval of time  $t$  does not exist any influence from the oscillations  $\omega_p$ , is given by Poisson's relation [14]:

$$\rho_E = \exp(-\omega_p t) \quad (10.10)$$

The resulting density of probability is obtained from relations (10.4) and (10.10):

$$\rho_{rez}(r, t) = \left[ \frac{1}{\left(2\pi \frac{\hbar}{m} t\right)^{3/2}} \exp\left(-\frac{r^2}{2 \frac{\hbar}{m} t}\right) \right] \exp(-\omega_p t) \quad (10.11)$$

The operator corresponding to relation (10.11) is [16]:

$$\frac{\hbar}{2m} \nabla^2 - \omega_p = \frac{\partial}{\partial t}$$

Based on relation (10.9) and on correction  $A = -i$ , it results:

$$\frac{\hbar^2}{2m} \nabla^2 + E_p = i\hbar \frac{\partial}{\partial t} \quad (10.12)$$

The generalisation for a field of forces of energy  $E_{p1}, E_{p2}, \dots, E_{pn}$  is made having as a starting point the resulting Poisson's density of probability [14]:

$$\rho_{E_{rez}} = \prod_{k=1}^n \exp\left(-\frac{E_{pk}}{\hbar} t\right) \quad (10.13)$$

From relations (10.4) and (10.13), Schrödinger's operator is obtained analogously:

$$-\frac{\hbar^2}{2m}\nabla^2 + \sum_{k=1}^n \mathbf{E}_{p,k} = i\hbar \frac{\partial}{\partial t} \quad (10.14)$$

### 10.3.2.2. The potential energy $\mathbf{E}_p(\mathbf{t})$ is a function of time

We associate the angular frequency to the potential energy  $\mathbf{E}_p(\mathbf{t})$ :

$$\omega_p(\mathbf{t}) = \frac{\mathbf{E}_p(\mathbf{t})}{\hbar} \quad (10.15)$$

The density of probability corresponding to Poisson's distribution is [14]:

$$\rho_E = \exp\left(-\int_0^t \omega_p(\tau) d\tau\right) \quad (10.16)$$

We introduce the notation:

$$\Omega(\mathbf{t}) = \int_0^t \omega_p(\tau) d\tau \quad (10.17)$$

Using the same reasoning as in previous cases, we obtain [14]:

$$\frac{\hbar}{2m}\nabla^2 - \frac{d\Omega}{dt} = \frac{\partial}{\partial t}$$

Based on relations (10.15) and (10.17) and on correction  $\mathbf{A} = -i$ , we obtain:

$$-\frac{\hbar^2}{2m}\nabla^2 + \mathbf{E}_p(\mathbf{t}) = i\hbar \frac{\partial}{\partial t} \quad (10.18)$$

### 10.3.2.3 Schrödinger's operator for a system of particles

Let us consider a system of particles, of masses  $m_1, m_2, \dots, m_n$  and electrical charges  $q_1, q_2, \dots, q_n$ . A density of probability corresponds to each particle:

$$\rho_k = \frac{1}{\left(2\pi \frac{\hbar}{m_k} t\right)^{3/2}} \exp\left(-\frac{r_k^2}{2 \frac{\hbar}{m_k} t}\right) \quad (10.19)$$

Where  $k = 1, 2, \dots$

It is obvious that the random motion of each particle is influenced by the random motion of the rest of the particles. Accordingly to the law of decomposition of the probabilities, we have:

$$\rho_{\text{rez}}(r_1, r_2, \dots, r_n, t) = \prod_{k=1}^n \frac{1}{\left(2\pi \frac{\hbar}{m_k} t\right)^{3/2}} \exp\left(-\frac{x_k^2 + y_k^2 + z_k^2}{2 \frac{\hbar}{m_k} t}\right) \quad (10.20)$$

We introduce the variables

$$\alpha_k = \frac{x_k}{\sqrt{2 \frac{\hbar}{m_k} t}} \quad \beta_k = \frac{y_k}{\sqrt{2 \frac{\hbar}{m_k} t}} \quad \gamma_k = \frac{z_k}{\sqrt{2 \frac{\hbar}{m_k} t}} \quad (10.21)$$

Relation (10.20) becomes:

$$\rho_{\text{rez}} = \frac{\prod_{k=1}^n \sqrt{\frac{m_k}{\hbar}}}{(2\pi t)^{3n/2}} \exp\left(-\frac{1}{2t} \sum_{k=1}^n (\alpha_k^2 + \beta_k^2 + \gamma_k^2)\right) \quad (10.22)$$

The operator corresponding to relation (10.22) is:



$$\sum_{k=1}^n \left( \frac{\partial^2}{\partial \alpha_k^2} + \frac{\partial^2}{\partial \beta_k^2} + \frac{\partial^2}{\partial \gamma_k^2} \right) = \frac{\partial}{\partial t} \quad (10.23)$$

We return to the spatial coordinates from relation (10.21) and we obtain:

$$\sum_{k=1}^n \frac{\hbar}{2m_k} \nabla_k^2 = \frac{\partial}{\partial t} \quad (10.24)$$

The spherical resulting wave, corresponding to the  $n$  annihilation phenomena is:

$$\sum_{k=1}^n \frac{1}{r_k} \exp \left[ -i\omega_k \left( t - \frac{r_k}{c} \right) \right] \quad (10.25)$$

where:

$$\omega_k = \frac{2m_k c^2}{\hbar}$$

Analogously, we impose that relation (10.25) to verify correction  $A = -i$  and relation (10.24) becomes:

$$\sum_{k=1}^n \left( -\frac{\hbar^2}{2m_k} \nabla_k^2 \right) = i\hbar \frac{\partial}{\partial t} \quad (10.26)$$

The  $n$  particles interacts Coulombian between them, with energies  $U_{l,r}$ . The indexes  $l$  and  $r$  take the values  $1, 2, \dots, n$ .

In the same time, each particle is found in an external field of potential  $U_k$ . The total energy of the system is:

$$\sum_{k=1}^n E_{pk} = \sum_{\substack{l,r=1 \\ l \neq r}}^n U_{l,r} + \sum_{k=1}^n U_k$$

Schrödinger's operator takes the more general form:

$$\sum_{k=1}^n \left( -\frac{\hbar^2}{2m_k} \nabla_k^2 \right) + \sum_{\substack{l,r=1 \\ l \neq r}}^n U_{l,r} + \sum_{k=1}^n U_k = i\hbar \frac{\partial}{\partial t} \quad (10.27)$$

Which is in conformity with [3].

#### 10.3.2.4. Schrödinger's operator for a particle found in the electromagnetic field

A particle of mass  $m$  and charge  $q$ , under the action of an electromagnetic field of potential magnetic vector  $\overline{A}_B$  gets the speed [6]:

$$\overline{v} = -\frac{q}{m} \overline{A}_B$$

The density of probability corresponding to the generation-annihilation process is:

$$\rho(x, y, z, t) = \frac{1}{\left(2\pi \frac{\hbar}{m} t\right)^{3/2}} \exp \left[ -\frac{(x - v_x t)^2 + (y - v_y t)^2 + (z - v_z t)^2}{2 \frac{\hbar}{m} t} \right] \quad (10.28)$$

The electromagnetic field's energy is:

$$E_p = \frac{q^2}{2m} \sum A_{Bi}^2 + qV \quad (10.29)$$

where  $i = x, y, z$

The operator corresponding to relations (10.28) and (10.29) is:

$$\frac{\hbar}{2m} \nabla^2 - \frac{q}{m} \sum_{i=1}^3 \mathbf{A}_{Bi} \frac{\partial}{\partial x_i} - \frac{q^2}{2m\hbar} \sum_{i=1}^3 \mathbf{A}_{Bi}^2 - \frac{qV}{\hbar} = \frac{\partial}{\partial t} \quad (10.30)$$

From the condition that the operator (10.30) verifies the solution of the spherical waves, we obtain the necessary corrections, so (10.30) gets the final form:

$$\frac{1}{2m} \left( -i\hbar \nabla - q\overline{\mathbf{A}}_B \right)^2 + qV = i\hbar \frac{\partial}{\partial t} \quad (10.31)$$

Which is in conformity [1], [3], etc.

We must make the observation that the operator (10.31) is correct only for speeds

$v \ll c$ , implying:  $\frac{q\mathbf{A}_B}{2m} \ll c_0$

If we project the operator (10.31) on the axis  $Ox$  and we impose that the plane wave

$\exp\left(-i\omega\left(t - \frac{x}{c}\right)\right)$  verifies the relation:

$$\frac{1}{2m} \left( -i\hbar \frac{\partial}{\partial x} - q\mathbf{A}_{Bx} \right)^2 = i\hbar \frac{\partial}{\partial t}$$

We obtain:

$$\frac{\hbar\omega}{2mc^2} \left( 1 - \frac{q\mathbf{A}_{Ax}}{\hbar\omega} \right)^2 = 1 \quad (10.32)$$

For  $\mathbf{A}_{Bx} = \mathbf{0}$  the relation verifies:

$$\hbar\omega = 2mc^2$$

For  $\mathbf{A}_B \neq \mathbf{0}$  we must have:

$$\frac{qA_B}{\hbar\omega} \ll 1$$

Taking into account that:

$$\hbar\omega = 2mc^2$$

We obtain the above mentioned condition:

$$A_B \ll 2mc/q \quad (10.33)$$

## 10.4. Fundamental operators in quantum mechanics

### 10.4.1. The impulse operator

The fundamental solution for the Schrödinger's operator, relation (10.8) is obtained from (10.4) and has the form:

$$\rho(\mathbf{r}, \mathbf{t}) = -\frac{i}{\hbar} \left( \frac{m}{2\pi\hbar\mathbf{t}} \right)^{-3/2} \exp\left( i \frac{m}{2\hbar\mathbf{t}} r^2 \right) \quad (10.34)$$

We take into consideration the standing Schrödinger operator [3]:

$$-\frac{\hbar^2}{2m} \nabla^2 = E \quad (10.35)$$

Written as follows:

$$-\frac{\hbar^2}{2m} \nabla(\nabla) = \frac{\mathbf{p}^{-2}}{2m} \quad (10.36)$$

And we impose that relation (10.34) verifies relation (10.36), we obtain:

$$-\hbar^2 \nabla \left( \frac{i\mathbf{m}}{\hbar t} (\mathbf{x}\bar{t} + \mathbf{y}\bar{j} + \mathbf{z}\bar{k}) \cdot \rho(r, t) \right) = (m\bar{v})^2 \cdot \rho(r, t) \quad (10.37)$$

The term  $(\mathbf{x}\bar{t} + \mathbf{y}\bar{j} + \mathbf{z}\bar{k})/t$  represents the particle's speed  $\bar{v}$ . Using simple calculus, we obtain the hermitic operator:

$$-i\hbar \nabla = \bar{P} \quad (10.38)$$

In which  $-i\hbar \nabla$  represents the impulse operator, which is in conformity with [1], [3].

#### 10.4.2. The deduction of the kinetic momentum operator

In the case in which the particle has a random motion on an arc of circle, the distance  $r$  from relation (10.34) is replaced with the length of the arc of circle  $S = \varphi R$ , in which  $\varphi$  represents the central angle and  $R$  represents the radius of the arc of circle. We study the motion in the  $\mathbf{xOy}$  plane.

Relations (10.34) and (10.36) become:

$$\rho(\varphi, t) = -\frac{i}{\hbar} \left( \frac{m}{2\pi\hbar t} \right)^{-3/2} \exp\left( i \frac{m}{2\hbar t} R^2 \varphi^2 \right) \quad (10.39)$$

$$-\frac{\hbar^2}{2m R^2} \frac{\partial}{\partial \varphi} \left( \frac{\partial}{\partial \varphi} \right) = \frac{L_z^2}{2m R^2} \quad (10.40)$$

We replace the fundamental solutions (10.39) in operator (10.40) and we obtain the hermitic operator of the projection of kinetic momentum on the  $\mathbf{Oz}$  axis:

$$-i\hbar \frac{\partial}{\partial \varphi} = L_z \quad (10.41)$$

By passing from the polar coordinates to the Cartesian ones, the operator (10.41) becomes:

$$-i\hbar \left( x \frac{\partial}{\partial x} - y \frac{\partial}{\partial y} \right) = \hat{L}_z \quad (10.42)$$

Analogously we obtain the components of the kinetic momentum on the axis of the Cartesian coordinate system:

$$-i\hbar \left( y \frac{\partial}{\partial z} - z \frac{\partial}{\partial y} \right) = \hat{L}_x \quad (10.43)$$

$$-i\hbar \left( z \frac{\partial}{\partial x} - x \frac{\partial}{\partial z} \right) = \hat{L}_y \quad (10.44)$$

Relations (10.42), (10.43), (10.44) are obtained formally from relation (10.38) by calculating the vectorial product at left with the position vector  $\bar{\mathbf{r}} = x\bar{\mathbf{i}} + y\bar{\mathbf{j}} + z\bar{\mathbf{k}}$ .

We obtain:

$$\bar{\hat{\mathbf{L}}} = \bar{\mathbf{r}} \times (-i\hbar \nabla) \quad (10.45)$$

Relation (10.45) is in conformity with [1], [3].

Relation (10.38) is also obtained formally from relation (10.36) through the “extraction of the square root”.

### 10.5. Obtaining Dirac's operator

The Dirac's relativistic invariant in time operator can be easily obtained, if we start from the scheme of the random motion, relation (10.1), written in Minkowski space:

$$\rho_{g,a} = \frac{1}{\left(\sqrt{2\pi \frac{\hbar}{m} t}\right)^4} \exp\left(-\frac{r^2 - c^2 t^2}{2 \frac{\hbar}{m} t}\right) \quad (10.46)$$

In order to write relation (10.46), there has to be made the observation that the scheme of the random motion implies movement back and forward both on the axes  $\mathbf{Ox}$ ,  $\mathbf{Oy}$ ,  $\mathbf{Oz}$  and on the axis of time. The back and forward motion on the time axis has at the bottom the fact that the generation-annihilation physical phenomenon is cyclical. The following operator corresponds to relation (10.46), [16]:

$$-\frac{\hbar^2}{2m} \left( \nabla^2 - \frac{1}{c^2} \frac{\partial^2}{\partial t^2} \right) = i\hbar \frac{\partial}{\partial t} \quad (10.47)$$

In which there has been made the necessary correction (number  $i$ ).

In the particular case of the Euclidian space, relation (10.47) becomes relation (10.8).

After mathematical calculations, relation (10.47) takes the equivalent form:

$$(i\hbar\nabla)^2 = \left( i \frac{\hbar}{c} \frac{\partial^2}{\partial t^2} \right) + \mathbf{q} \frac{i\hbar}{c} \mathbf{mc} \frac{\partial}{\partial t} \quad (10.48)$$

We take as a reference element, in the second term from relation (10.48), the expression  $\mathbf{mc}^2$ , which corresponds to the energy of the recoil particle  $\frac{(-\mathbf{mc})^2}{2m}$  from theorem T.5.

Relation (10.48) becomes:

$$(\i\hbar\nabla)^2 = \left( i \frac{\hbar}{c} \frac{\partial}{\partial t} + mc \right)^2 \quad (10.49)$$

The operator (10.49) has to describe the random motion in the Minkowski space for  $\pm \mathbf{x}, \pm \mathbf{y}, \pm \mathbf{z}, \pm t$ .

For negative values of the time, relation (10.49) becomes:

$$(\i\hbar\nabla)^2 = \left( i \frac{\hbar}{c} \frac{\partial}{\partial t} - mc \right)^2 \quad (10.50)$$

The operators (10.49) and (10.50) **describe together** the random motion in the Minkowski space. There will be four operators corresponding to the two spin's orientations: two operators for  $t > 0$  relation (10.49) and two operators for  $t < 0$ ; relation (10.50)

**For  $t > 0$**

$$\begin{aligned} \text{spin } \uparrow (-\i\hbar\nabla)^2 &= \left( i \frac{\hbar}{c} \frac{\partial}{\partial t} + mc \right)^2 \\ \text{spin } \downarrow (-\i\hbar\nabla)^2 &= \left( i \frac{\hbar}{c} \frac{\partial}{\partial t} + mc \right)^2 \end{aligned} \quad (10.51)$$

**For  $t < 0$**

$$\begin{aligned} \text{spin } \uparrow (-\i\hbar\nabla)^2 &= \left( i \frac{\hbar}{c} \frac{\partial}{\partial t} - mc \right)^2 \\ \text{spin } \downarrow (-\i\hbar\nabla)^2 &= \left( i \frac{\hbar}{c} \frac{\partial}{\partial t} - mc \right)^2 \end{aligned} \quad (10.52)$$

Relations (10.51) and (10.52) can be written in a unitary form, if we introduce the operators:



$$\begin{aligned}
\hat{\alpha}_x &= \begin{pmatrix} 0 & 0 & 0 & 1 \\ 0 & 0 & 1 & 0 \\ 0 & 1 & 0 & 0 \\ 1 & 0 & 0 & 0 \end{pmatrix} & \hat{\alpha}_y &= \begin{pmatrix} 0 & 0 & 0 & -i \\ 0 & 0 & i & 0 \\ 0 & -i & 0 & 0 \\ i & 0 & 0 & 0 \end{pmatrix} \\
\hat{\alpha}_z &= \begin{pmatrix} 0 & 1 & 0 & 0 \\ 0 & 0 & 0 & -1 \\ 1 & 0 & 0 & 0 \\ 0 & 0 & -1 & 0 \end{pmatrix} & \hat{\alpha}_t &= \begin{pmatrix} 1 & 0 & 0 & 0 \\ 0 & 1 & 0 & 0 \\ 0 & 0 & 1 & 0 \\ 0 & 0 & 0 & 1 \end{pmatrix} = \hat{\mathbf{1}} \\
\hat{\alpha}_m &= \begin{pmatrix} 1 & 0 & 0 & 0 \\ 0 & 1 & 0 & 0 \\ 0 & 0 & -1 & 0 \\ 0 & 0 & 0 & -1 \end{pmatrix} & & & & & & & (10.53)
\end{aligned}$$

From relations (10.51), (10.52) and (10.53) we obtain:

$$-i\hbar\bar{\alpha}\nabla = i\frac{\hbar}{c}\hat{\mathbf{1}}_t\frac{\partial}{\partial t} + mc\hat{\alpha}_m \quad (10.54)$$

In the situation in which the particle is found in an electromagnetic field also, the operator (10.31) is rewritten in Minkowski space, accordingly to relation (10.54) and we obtain:

$$\left(-i\hbar\nabla - q\bar{\mathbf{A}}_B\right)\hat{\alpha} + qV\hat{\mathbf{1}} = i\frac{\hbar}{c}\frac{\partial}{\partial t}\hat{\mathbf{1}}_t + mc\hat{\alpha}_m \quad (10.55)$$

## CONCLUSIONS

- *The elementary particles have a random motion in space, caused by the generation-annihilation phenomenon.*
- *The random motion of the elementary particles is described by the diffusion operator.*
- *Schrödinger's operator is obtained from the condition that the diffusion operator verifies the equation of spherical waves resulted from the generation-annihilation process.*
- *Schrödinger's operator for a system of particles that are found in a given energy field is obtained from the decomposition of the corresponding probabilities.*
- *Dirac's operator is obtained from the generalization of the generation-annihilation phenomenon Minkovski space.*
- *All the observable physical quantities: energy, impulse, kinetic momentum, correspond to the hermitic operators.*
- *Mathematical relations between physical quantities are identical with the mathematical relations between the associated mathematical operators.*

---



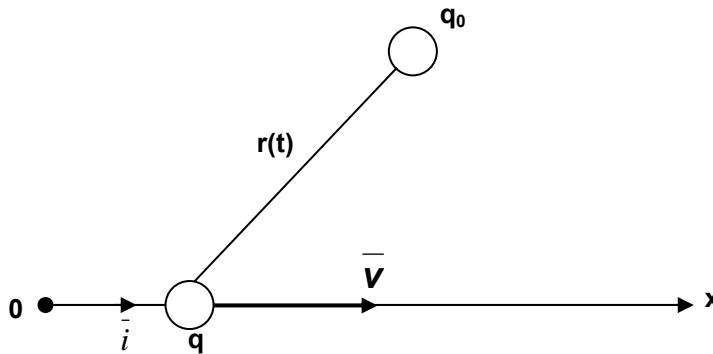
---

## 11. ELECTRODYNAMICS

### 11.1. The electromagnetic law of induction (second law and Maxwell's law)

Let us consider two electrical charges  $q$  and  $q_0$  in vacuum.

The first electrical charge  $q$  moves uniformly, non-relativistic, with the constant speed  $v \ll c_0$ , after the  $Ox$  axis, in reference with the second charge  $q_0$ , that is standing still in space, fig 11.1.



**Fig 11.1. Electrical energy of interaction between two electrical charges**

The electrical energy of interaction between the two charges is a function of time:

$$W_{el}(t) = \frac{qq_0}{4\pi\epsilon_0 r(t)} \quad (11.1)$$

Correspondingly to the electrical energy (11.1), the field mass results:

$$m_c(t) = \frac{qq_0}{4\pi\epsilon_0 r(t)c_0^2} \quad (11.2)$$

The impulse of the field mass,  $\bar{p}_c(t)$  is obtained from relation (11.2)

$$\bar{p}_c(t) = \frac{qq_0}{4\pi\epsilon_0 r(t)} \frac{\bar{v}}{c_0^2} \quad (11.3)$$

The impulse variable in time represents the inertial force:

$$\bar{F}_{in} = -\frac{d\bar{p}_c}{dt} = -\frac{d}{dt} \left( \frac{qq_0}{4\pi\epsilon_0 r(t)} \frac{\bar{v}}{c_0^2} \right) \quad (11.4)$$

As shown in chapter 6, a gravitational force corresponds to the inertial force or accordingly to chapter 7, an electrical force that acts over the electrical charge  $q_0$ .

Corresponding to relation (11.4), we define the electric field:

$$\bar{E}_s = \frac{\bar{F}_{in}}{q_0} = -\frac{d}{dt} \left( \frac{q}{4\pi\epsilon_0 r(t)} \frac{\bar{v}}{c_0^2} \right) = -\frac{\partial}{\partial t} \bar{A}_B(t) \quad (11.5)$$

We call such a field, a solenoidal electric field. In relation (11.5)  $\bar{A}_B$  represents the potential magnetic vector and it is defined as follows:

$$\bar{A}_B = V \frac{\bar{v}}{c_0^2} \quad (11.6)$$

The quantity  $V$  represents the scalar electrical potential.

Relation

$$\bar{E}_s = -\frac{\partial \bar{A}_B}{\partial t} \quad (11.7)$$

Represents **the electromagnetic law of induction** (second Maxwell's law) which we rewrite under the form Maxwell has given:

$$\text{rot} \bar{E}_s = -\frac{\partial \bar{B}}{\partial t} \quad (11.8)$$

### 11.2. The law of the magnetic circuit (Maxwell's first law)

In relation (11.6), we apply to both terms the rotor operator:

$$\mathit{rot} \bar{\mathbf{A}}_B = \mathit{rot} \left( \mathbf{V} \frac{\bar{\mathbf{v}}}{c_0^2} \right) \quad (11.9)$$

We use the development:

$$\nabla \times \left( \mathbf{V} \frac{\bar{\mathbf{v}}}{c_0^2} \right) = \mathbf{V} \left( \nabla \times \frac{\bar{\mathbf{v}}}{c_0^2} \right) + (\nabla) \times \frac{\bar{\mathbf{v}}}{c_0^2}$$

And relations:

$$\nabla \times \frac{\bar{\mathbf{v}}}{c_0^2} = 0$$

$$\nabla \mathbf{V} = -\bar{\mathbf{E}}$$

After calculus made in relation (11.9), we obtain:

$$\bar{\mathbf{B}} = \frac{\bar{\mathbf{v}}}{c_0^2} \times \bar{\mathbf{E}} \quad (11.10)$$

In relation (11.10)  $\bar{\mathbf{B}}$  represents the magnetic induction, meanwhile  $\bar{\mathbf{E}}$  represents the intensity of the electric field.

We apply the rotor operator to the relation (11.10):

$$\mathit{rot} \bar{\mathbf{B}} = \frac{1}{c_0^2} \mathit{rot} (\bar{\mathbf{v}} \times \bar{\mathbf{B}}) \quad (11.11)$$

Accordingly to the development:

$$\mathit{rot} (\bar{\mathbf{v}} \times \bar{\mathbf{E}}) = (\bar{\mathbf{E}} \nabla) \bar{\mathbf{v}} - (\bar{\mathbf{v}} \nabla) \bar{\mathbf{E}} + (\nabla \bar{\mathbf{E}}) \bar{\mathbf{v}} - (\nabla \bar{\mathbf{v}}) \bar{\mathbf{E}} \quad (11.12)$$

And to the relations:

$$\begin{cases} \nabla \bar{\mathbf{v}} = \mathbf{0} \\ \nabla \bar{\mathbf{E}} = \frac{\rho}{\varepsilon_0} \end{cases} \quad (11.13)$$

We obtain:

$$\text{rot} \bar{\mathbf{B}} = \frac{1}{c_0^2} \left[ -(\bar{\mathbf{v}} \nabla) \bar{\mathbf{E}} + \frac{\rho}{\varepsilon_0} \bar{\mathbf{v}} \right] \quad (11.14)$$

Based on relation

$$\frac{\partial \bar{\mathbf{E}}}{\partial \mathbf{x}} = \frac{\partial \bar{\mathbf{E}}}{\partial t} \cdot \frac{d\mathbf{t}}{d\mathbf{x}} = \frac{\partial \bar{\mathbf{E}}}{\partial t} \left( -\frac{\mathbf{1}}{\bar{\mathbf{v}}} \right) \quad (11.15)$$

Expression (11.14) becomes:

$$\text{rot} \bar{\mathbf{B}} = \frac{\rho}{\varepsilon_0 c_0^2} \bar{\mathbf{v}} + \frac{1}{c_0^2} \frac{\partial \bar{\mathbf{E}}}{\partial t} \quad (11.16)$$

We introduce the quantities:

$$\begin{aligned} \mu_0 &= \frac{1}{\varepsilon_0 c_0^2} & \bar{\mathbf{B}} &= \mu_0 \bar{\mathbf{H}} \\ \bar{\mathbf{J}} &= \rho \bar{\mathbf{v}} & \bar{\mathbf{D}} &= \varepsilon_0 \bar{\mathbf{E}} \end{aligned}$$

And we obtain in the end **the law of the magnetic circuit** (first Maxwell's relation):

$$\text{rot} \bar{\mathbf{H}} = \bar{\mathbf{J}} + \frac{\partial \bar{\mathbf{D}}}{\partial t} \quad (11.17)$$

### 11.3. Lorentz calibration

In relation (11.6) we apply the divergence operator to both terms:

$$\mathbf{div} \bar{\mathbf{A}}_B = \frac{1}{c_0^2} \mathbf{div}(\mathbf{V} \bar{\mathbf{v}}) \quad (11.18)$$

We use the development:

$$\nabla(\mathbf{V} \bar{\mathbf{v}}) = (\nabla \bar{\mathbf{v}}) \mathbf{V} + (\nabla \mathbf{V}) \bar{\mathbf{v}} \quad (11.19)$$

And relations:

$$\left\{ \begin{array}{l} \nabla \bar{\mathbf{v}} = \mathbf{0} \\ \nabla \mathbf{V} = \frac{\partial \mathbf{V}}{\partial \mathbf{x}} \bar{\mathbf{j}} = \frac{\partial \mathbf{V}}{\partial t} \frac{d\mathbf{t}}{d\mathbf{x}} \bar{\mathbf{j}} = -\frac{\partial \mathbf{V}}{\partial t} \frac{\mathbf{1}}{\mathbf{v}} \end{array} \right. \quad (11.20)$$

So the relation (11.18) becomes in the end:

$$\mathbf{div} \bar{\mathbf{A}}_B + \frac{1}{c_0^2} \frac{\partial \mathbf{V}}{\partial t} = \mathbf{0} \quad (11.21)$$

Meaning the *condition of Lorentz calibration*.

## CONCLUSIONS

- *The electromagnetic law of induction is a consequence of the inertial force, generated by the mass associated to the electrical interaction energy, variable in time;*
- *The magnetic potential vector is the electric potential scalar in motion;*
- *The magnetic field is the vector electric field in motion;*
- *The law of the magnetic circuit is a consequence of the magnetic field, variable in time and of the electrical charges in motion.*



## 12. THERMODYNAMICS

### 12.1. The electrodynamics theory of the thermodynamics

#### 12.1.1 The electromagnetic radiation of the neuter atoms

It is well known the fact that an electrical charge  $q$  in motion with the acceleration  $a$  radiates electromagnetic power, expressed by Lienard's formula [8], [11]:

$$P = \frac{q^2 a^2}{6\pi\epsilon_0 c_0^3} \quad (12.1)$$

Equation (12.1) has a square form of  $q$  and  $a$ , so the electromagnetic power does not depend on the sign of  $q$  and  $a$ .

Accordingly to this observation, it results that an atom in accelerated motion, even though is neuter from an electrical point of view, it emits electromagnetic radiation through both the negative electrical charges and the positive nucleus. The oscillating movement of the atom can have as a cause a force of exterior mechanical nature, as well as a force of electrical nature.

We consider that the force of electrical nature is generated by an electromagnetic wave. Under the action of the electrical component of the electromagnetic wave, the electrical charges from the atom get an oscillating motion.

Let  $a_e$  be the acceleration of the electrons and  $a_p$  the acceleration of the nucleus.

Accordingly to relation (12.1) the neuter atom will emit a power:

$$P = \frac{(Zq)^2}{6\pi\epsilon_0 c_0^3} (a_e^2 + a_p^2) \quad (12.2)$$

In relation (12.2) we define an equivalent acceleration  $a_{equiv}$  with which the atom emits an electromagnetic power, given by the formula:

$$P = \frac{(Zq)^2}{6\pi\epsilon_0 c_0^3} a_{echiv}^2 \quad (12.3)$$

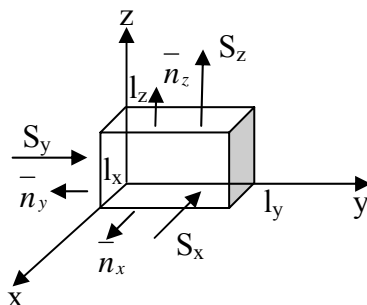
Relation (12.3) shows that we can interpret the neuter atom that has an oscillation motion as ***an electric dipole which emits or absorbs electromagnetic energy.***

From an electrical point of view, a chemical substance can be compared as a theoretical infinite mass of electromagnetic oscillators which emit and absorb electromagnetic waves, all in the same time.

### 12.1.2. Fourier's law of thermoconduction

We consider the chemical reactions as a primary source of electromagnetic radiation. The electromagnetic energy is emitted with the same probability in all directions. The interaction between the electromagnetic waves of high frequency from the thermo spectrum interacts with the atoms that are put in oscillation movement. The oscillations of the neuter atoms take place with equal probability in all directions.

Let us consider a coordinate system ***xzy*** and an electromagnetic wave, characterized by the Poynting vector  $\overline{S}$ . Let  $\overline{S}_x, \overline{S}_y, \overline{S}_z$  be the components of the vector after the coordinate system and a parallelepiped with the sides  $(l_x, l_y, l_z)$  and the norms  $(\overline{n}_x, \overline{n}_y, \overline{n}_z)$ , figure 12.1.



**Figure 12.1. The representation of the breakthrough of the electromagnetic field in the elementary parallelepiped**

We write the energetic balance in the volume defined by the parallelepiped  $\Omega$ . The electromagnetic energy that breaks through the volume is found in the oscillations movement of the atoms. Let  $\bar{\mathbf{v}}(\mathbf{v}_x, \mathbf{v}_y, \mathbf{v}_z)$  be the oscillation's speed of the atom inside the parallelepiped at a given moment of time and  $\bar{\mathbf{F}}(\mathbf{F}_x, \mathbf{F}_y, \mathbf{F}_z)$ , the force that acts upon them.

The energetic balance is:

$$\begin{cases} -S_y I_x I_z = v_y F_y \\ -S_z I_y I_x = v_z F_z \\ -S_x I_z I_y = v_x F_x \end{cases} \quad (12.4)$$

From the theory of the generalized forces, the components of the force have the following expressions:

$$\begin{cases} F_x = \frac{\partial}{\partial \mathbf{x}} (I_x I_y I_z \mathbf{w}) \\ F_y = \frac{\partial}{\partial \mathbf{y}} (I_x I_y I_z \mathbf{w}) \\ F_z = \frac{\partial}{\partial \mathbf{z}} (I_x I_y I_z \mathbf{w}) \end{cases} \quad (12.5)$$

In which  $\mathbf{w}$  represents the density of electromagnetic energy.

From relations (12.4) and (12.5) we obtain:

$$\begin{cases} -S_x = I_x \frac{\partial \mathbf{w}}{\partial \mathbf{x}} v_x \\ -S_y = I_y \frac{\partial \mathbf{w}}{\partial \mathbf{y}} v_y \\ -S_z = I_z \frac{\partial \mathbf{w}}{\partial \mathbf{z}} v_z \end{cases} \quad (12.6)$$

Due to the fact that the motion is made with equal probability after any direction, it results that:

$$v_x = v_y = v_z = \frac{v}{6} \quad (12.7)$$

$$I_x = I_y = I_z = I \quad (12.8)$$

We introduce relations (12.7) and (12.8) in (12.6), we multiply them with the versors of the axes  $\bar{i}$ ,  $\bar{j}$ ,  $\bar{k}$ , then we sum them up and we obtain relation:

$$\bar{S} = -D \cdot \text{grad } w \quad (12.9)$$

$D = \frac{vl}{6}$  represents the diffusion coefficient.

The electromagnetic density of energy  $w$  can be expressed as a function of Boltzman's constant  $k_B$  and the number of units, the absolute temperature  $T$ :

$$w = k_B T \quad (12.10)$$

Relation (12.10) is introduced in relation (12.9) and we obtain:

$$\bar{S} = -Dk_B \text{grad } T \quad (12.11)$$

We introduce the coefficient of thermo conductivity:

$$K = Dk_B = \frac{vl}{6} k_B \quad (12.12)$$

We return to relation (12.11) and we obtain:

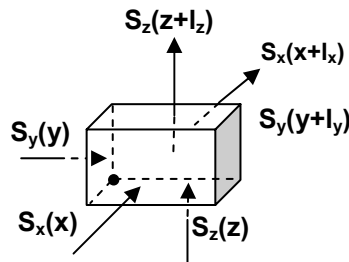
$$\bar{S} = -K \text{grad } T \quad (12.13)$$

In thermodynamics, the quantity  $\mathbf{S}$  from relation (12.13) represents the density of the heat current  $\bar{\mathbf{q}}$ , so that, relation (12.13) describes Fourier's **law of thermoconduction**:

$$\bar{\mathbf{q}} = -K\text{grad}T \quad (12.14)$$

### 12.1.3. The equation of the heat propagation

In order to obtain the equation of the heat propagation from Maxwell's equations, we will utilise the reasoning from the previous paragraph at which we will add the condition that a part of the energy which breaks through the considered volume  $\Omega$  is radiated through the side surface  $\Sigma$ , as in figure 12. 2.



**Figure 12.2. The energetic balance in the elementary parallelepiped**

We develop in Taylor series the components of the Poynting vector:

$$\begin{cases} \mathbf{S}_x(\mathbf{x} + l_x) = \mathbf{S}_x(\mathbf{x}) + l_x \frac{\partial \mathbf{S}_x}{\partial \mathbf{x}} \\ \mathbf{S}_y(\mathbf{y} + l_y) = \mathbf{S}_y(\mathbf{y}) + l_y \frac{\partial \mathbf{S}_y}{\partial \mathbf{y}} \\ \mathbf{S}_z(\mathbf{z} + l_z) = \mathbf{S}_z(\mathbf{z}) + l_z \frac{\partial \mathbf{S}_z}{\partial \mathbf{z}} \end{cases} \quad (12.15)$$

After writing the energetic balance on the axis  $\mathbf{Ox}$  we obtain:

$$-\mathbf{S}_x I_y I_z + \left( \mathbf{S}_x + I_x \cdot \frac{\partial \mathbf{S}_x}{\partial \mathbf{x}} \right) I_y I_z = -\frac{\partial}{\partial t} (I_x I_y I_z w)$$

From where it results that:

$$\frac{\partial \mathbf{S}_x}{\partial \mathbf{x}} = -\frac{\partial w}{\partial t} \quad (12.16)$$

By generalizing after the three axes, it results that:

$$\mathbf{div} \bar{\mathbf{S}} = -\frac{\partial w}{\partial t} \quad (12.17)$$

We substitute relation (12.9) in (12.17) and we obtain:

$$D\nabla^2 w = -\frac{\partial w}{\partial t} \quad (12.18)$$

For  $w = k_B T$ , relation (12.18) becomes *the equation of the heat propagation*:

$$D\nabla^2 T - \frac{\partial T}{\partial t} = 0 \quad (12.19)$$

## 12.2. The entropy

The concept of entropy refers to the disorder in a system of atoms. If the system starts with same kind of order, this will decay in time. What was once an organization in the system will become a chaotic motion of the atoms. The second law of thermodynamics states as a universal physical principle, that what was once an organized structure will destroy itself sooner or later, without any chance of getting back by its own to the old organization.

Through the utilization of the model offered by thermodynamics and the theory of probability, the concept of entropy can be explained as follows:

We consider an isolated system of atoms, in which a single atom is moving. At a certain moment of time, it interacts with other atoms and it breaks. As a consequence of the interaction, electromagnetic waves are emitted in all directions, which interact directly with some of the atoms at rest. After the interaction, the atoms at rest start moving, so they emit electromagnetic waves that interact with the following atoms. The phenomenon is produced in avalanche, so that the disorder propagates with the electromagnetic waves.

We reach the conclusion that any **electromagnetic wave carries the germs of disorder**. It is sufficient to meet other atoms so that the disorder starts acting in real. By probabilistic mediation, we can say that it is sufficient to have a gradient of the density of electromagnetic energy, so that the disorder starts propagate.

In thermodynamics, it is stated that the entropy is irreversible. In order to explain this, it is given the example with the glass of water that breaks and it is said that it is impossible to make the whole glass by its own. It is the entropy that forbids this phenomenon from happening.

From the above presented theory point of view, the phenomena are explained as follows:

In order for the glass to have the given shape, the constitutive atoms are linked together through different forms of chemical bonds. After breaking, the atoms on one side and the other of the surface that defines the crack have been moved so that they have emitted electromagnetic waves in different directions with different intensities. The electromagnetic waves do not come back with the same intensity and orientation in each point of the crack in order to rebuild the glass. With other word, we have in the first stage the irreversibility of the propagation of the electromagnetic waves (if they do not encounter other atoms) and in the second phase, the extremely small probability that the waves which come back on the surface of the crack to be identical with the ones from the emission, when the glass broke. When in average the structure is remade, we say that reversible physical phenomena took place.

In a given system in order not to take place the physical phenomenon of growth of entropy, it is obvious that no source of electromagnetic waves must exist,

so no electron should move. This thing happens at absolute zero, so we find the third law of thermodynamics (at  $T = 0$ ,  $S = 0$ ).

### **12.3 The V. Karpen phenomenon**

The electric piles invented by V. Karpen, produce electric energy only by using the thermo energy from the surroundings, which at this level of knowledge contradicts the second law of thermodynamics. The explanation of the physical phenomenon using the facts above presented is the following:

One of the electrodes is made of porous platinum, meaning a very large number of resonant cavities linked together. The thermo energy is of electromagnetic nature, so the pores, meaning the resonant cavities are excited, get to resonance and put in movement the electrical charges from the solution of  $H_2SO_4$ . The motion, in probabilistic average, of the electric charges defines the current from the Karpen pile. So, the energy for functioning is taken from the thermo energy (electromagnetic one) from the surroundings. The porous medium represents a “converter”, with resonant cavities which, when they are tuned on the thermo frequency, get in resonance and give the electrical energy at constant voltage. As it is working, the temperature of the porous platinum decreases in time, which shows that it is consumed from the electromagnetic energy (thermo frequency), stored in the walls of the pores (cavities). It is obvious that we are not dealing with any kind of “perpetuum mobile”.



## CONCLUSIONS

- *Fourier's equation is obtained having as a starting point the law of energy conservation, the Poynting vector, the theorem of the generalized forces and the calculus of probabilities, meaning of the macroscopic static electrodynamics.*
- *The equation of propagation of heat is obtained from the theorem of the electromagnetic energy and Fourier's equation.*
- *The entropy represents an application of the macroscopic static electrodynamics and of the propagation of electromagnetic waves in material mediums.*
- *The Karpen electric piles represent converters of electromagnetic energy based on resonance chambers (the pores of the material) which are excited on certain high frequencies (thermo) by the electromagnetic waves which define the thermo energy, in the purpose of obtaining direct current.*

### 13. COSMOLOGY AND THE ARROW OF TIME

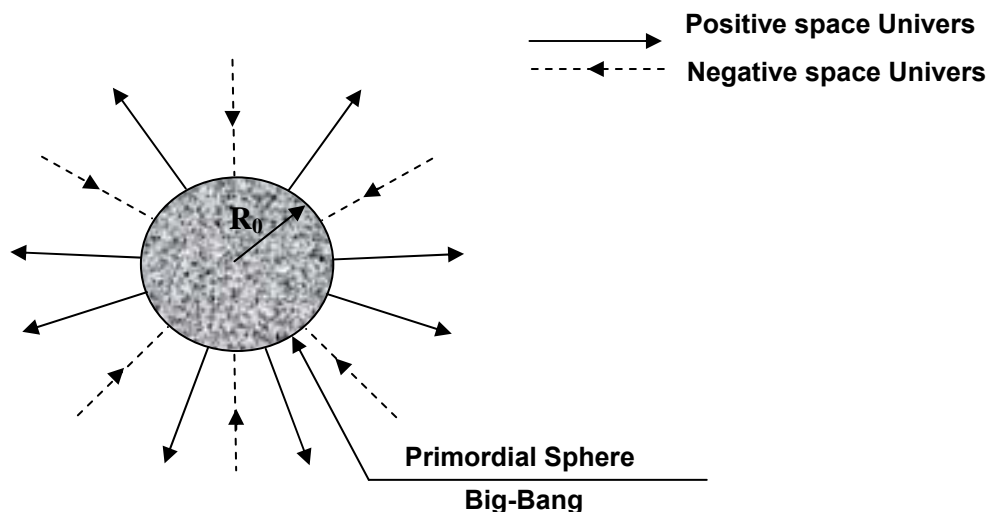
#### 13.1. The physical fundamentals of space and time

The description of vacuum with the Planck space-time quanta as an elastic medium brings new possibilities of studying the properties of the Universe.

The model of forming elementary particles will be generalized at cosmic scale.

In the description of the elementary particles we have considered that from the fundamental sphere of radius  $r_0$  a Planck quantum of a certain polarity has been expelled, disturbing the equilibrium between the positive and negative Planck quanta. Analogously, we will consider a *Primordial Sphere* of radius  $R_0$ , from which *all* space-time Planck quanta of a certain polarity have been expelled. Inside the *Primordial Sphere* of radius  $R_0$  are only found space-time Planck quanta of a certain polarity. The exterior of the Primordial Sphere is a curved space of Riemann metric, formula (3.25).

At a given moment in time, the space-time Planck quanta inside the Primordial Sphere start moving from the inside to the outside, meanwhile the space-time Planck quanta of opposite polarity moves backwards, as fig 13.1

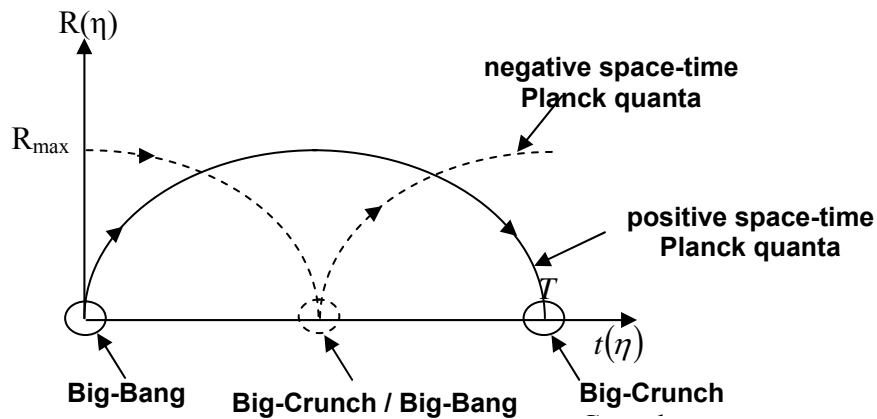


**Figure 13.1. The Big-Bang**

The phenomenon takes place until the polarity of the primordial Sphere changes.

The explosion of the space-time Planck quanta from inside the Primordial Sphere is in fact the Big-Bang. In the moment in which the Universe described by the space-time Planck quanta of a certain polarity gets to a maximum, the space-time Planck quanta of the opposite polarity have been filled the whole interior of the Primordial Sphere.

Their Big-Bang constitute the beginning of the collapse for the opposite signs quanta, figure 13.2.



**Fig.13.2. The space-time diagram of the Universe**

Based on the mechanism described earlier it results that the radius of the Universe at a certain moment of time, is given by relation:

$$r(\eta) = \frac{R_{\max}}{2} (1 - \cos \eta), \quad \eta \in [\eta_0, 2\pi - \eta_0] \quad (13.1)$$

in which  $\eta$  is a parameter.

For  $\eta = \eta_0$  we have the initial state of radius  $R_0$  (Primordial Sphere):

$$R_0 = \frac{R_{\max}}{2} (1 - \cos \eta_0) \quad (13.2)$$

The acceleration of the space Planck quanta which describe the Universe in expansion have the expression:

$$\mathbf{a} = \frac{d^2 r(\eta)}{dt^2(\eta)} \quad (13.3)$$

Accordingly to the general relativity theory, the acceleration  $\mathbf{a}$  must be equal with the gravitational acceleration field:

$$\mathbf{a} = \frac{GM_u}{r^2(\eta)} \quad (13.4)$$

Where  $M_u$  is the mass of the whole Planck quanta in the Primordial Sphere from whose energy will then be formed all the galaxies.

From relations (13.3) and (13.4) it results that:

$$\frac{d^2 r(\eta)}{dt^2(\eta)} = \frac{GM_u}{r^2(\eta)} \quad (13.5)$$

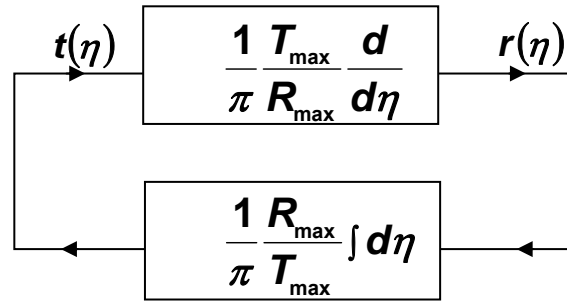
Knowing the expression of the radius of Universe as a function of  $\eta$  - relation (13.1), from the differential equation (13.5) we obtain the expression of the cosmic time:

$$t(\eta) = \frac{T_{\max}}{2\pi} (\eta - \sin \eta), \quad \eta \in [\eta_0, 2\pi - \eta_0] \quad (13.6)$$

Where  $T_{\max}$  is the lifetime of the Universe.

Based on relations (13.1) and (13.6) the diagram from 13.3 results:

Relations (13.1) and (13.6) are identical with the ones obtained by A. Fiedmann [5], [11].



**Figure 13.3. The causal dependence of space-time**

The above diagram shows that **space generates time and time generates space**. The space-time diagram reminds us of the Maxwell's equations, chapter 11, in which the electric and magnetic field generates each other without needing a "support" for propagation. Analogously, neither space nor time need a support of existence besides the relations system (13.1) and (13.6), meaning they are **independent background**.

### 13.2. What does the elapsing of time represents

As shown in chapter 4, the space-time Planck quanta have in composition:

- The quantum of electrical charge;
- The time quantum.

It is known that the motion of the electrical charges quanta with a certain speed leads to the notion of density of electrical current. It results that the motion of the time Planck quanta leads to a new physical quantity that we call **cosmic time**.

If there is the law of the conservation of charge for the electrical charge, then it must exist something similar for the quanta of time:

$$\mathit{div} \bar{J}_t(\eta) = - \frac{\partial \rho_t(\eta)}{\partial t(\eta)} \quad (13.7)$$

In which:

$\rho_t(\eta)$  = the density of the Planck quanta of time

$J_t(\eta)$  = the density of the current of quanta of time, meaning the cosmic time.

We consider two concentric spheres, attached to the quanta of space-time in motion, for two different values of  $\eta$ :  $\mathbf{S}(\eta_1)$  and  $\mathbf{S}(\eta_2)$ .

The quantity of the whole Planck quanta of time comprised between the two spheres must be an invariant in reference with the parameter  $\eta$ . From relation (13.7) we obtain:

$$\int \bar{\mathbf{J}}_t(\eta) d\bar{\mathbf{s}} = -\frac{\partial}{\partial \eta} \left( \int_{\Omega_\Sigma} \rho_t d\mathbf{v} \right) \frac{\partial \eta}{\partial t} = \mathbf{0} \quad (13.8)$$

where:  $\Sigma = \mathbf{S}(\eta_1) \cup \mathbf{S}(\eta_2)$

In spherical coordinates relation (13.8) becomes:

$$\frac{dJ_t}{dr} + \frac{2}{r} J_t = 0 \quad (13.9)$$

The solution of the differential equation (13.9) is:

$$J_t = \frac{k}{r^2} \quad (13.10)$$

where  $k$  is a constant.

Based on relation (13.4), in which acceleration  $\mathbf{a}$  is proportional to  $\frac{1}{r^2}$ , it results that the cosmic time from relation (13.10) is proportional to acceleration  $\mathbf{a}$ :

$$J_t = ka \quad (13.11)$$

Relation (13.11) shows that ***the lapse of time is proportional to the accelerated motion of the Planck quantum of time*** (“the charges” of time)

### 13.3. The space –time dimensions of the Universe

We want to calculate the space-time dimensions of the Universe, based on the theory presented in the previous chapter. The quantities that must be calculated are:

- $T_{\max}$  = The lifetime of the Universe
- $R_{\max}$  = The maximum radius of the Universe
- $R_0$  = The radius of the Primordial Sphere of the Universe

In order to calculate the space-time dimensions of the Universe, we start from the expression for the speed of expansion of the Universe:

$$v = \frac{dr(\eta)}{dt} = \frac{dr(\eta)}{d\eta} \frac{d\eta}{dt(\eta)} \quad (13.12)$$

We substitute relations (13.1) and (13.6) in relation (13.12) and we obtain:

$$v = \pi \frac{R_{\max}}{T_{\max}} \frac{\sin \eta}{1 - \cos \eta} \quad (13.13)$$

Relations (13.1) and (13.6), at the scale  $c_{0t}$ , represents in the Euclidian space, the parametric equations of the cycloid. Based on the previous observations, it results the speed of the transversal waves as a function of  $R_{\max}$  and  $T_{\max}$  :

$$c_{0t} = \pi \frac{R_{\max}}{T_{\max}}$$

In order to express all the physical quantities as a function of the propagation velocities of the elastic waves, the expansion velocity is the velocity of the longitudinal waves  $c_{0l}$  - relation (5.15).

With these specifications, we obtain:

$$\left\{ \begin{array}{l} c_{0t} = \pi \frac{R_{\max}}{T_{\max}} \\ c_{0l} = \pi \frac{R_{\max}}{T_{\max}} \frac{\sin \eta_0}{1 - \cos \eta_0} \end{array} \right. \quad (13.14)$$

Knowing that:

$$\left\{ \begin{array}{l} c_{0t} = 3 \cdot 10^8 \text{ m/s} \\ c_{0l} = 3,22 \cdot 10^{28} \text{ m/s} \end{array} \right. \quad (13.15)$$

From relations (13.14) it results that:

$$\frac{c_{0l}}{c_{0t}} = \frac{\sin \eta_0}{1 - \cos \eta_0} \quad (13.16)$$

We introduce the change of variable:

$$\left\{ \begin{array}{l} \sin \eta_0 = \frac{2t}{1+t^2} \\ \cos \eta_0 = \frac{1-t^2}{1+t^2} \end{array} \right. \quad (13.17)$$

Where:

$$\operatorname{tg} \frac{\eta_0}{2} = t$$

From relations (13.16) and (13.17) it results that:

$$\sin \eta_0 = \frac{2c_{0t}}{c_{0l}} \quad (13.18)$$



The value of  $\eta_0$  from the above relation is obtained from the development in series of the function arcsine:

$$\eta_0 = \frac{2c_{0t}}{c_{0l}} + \frac{1}{6} \left( \frac{2c_{0t}}{c_{0l}} \right)^3 \quad (13.19)$$

Accordingly to relation (13.6) giving the parameter  $\eta$  the value  $\eta_0$ , we obtain the Planck time:

$$t_{pl} = \frac{T_{\max}}{2\pi} (\eta_0 - \sin \eta_0) \quad (13.20)$$

From relations (13.18), (13.19) and (13.20) we determine the expression for the lifetime of the Universe:

$$T_{\max} = \frac{3\pi}{2} t_{pl} \frac{c_{0l}^3}{c_{0t}^3} \quad (13.21)$$

Knowing that:

$$t_{pl} = 0,5391 \cdot 10^{-43} \text{ s}$$

And utilising relations (13.6) and (13.21) we obtain:

$$T_{\max} = 3,1397 \cdot 10^{17} \text{ s} \quad (13.22)$$

We return to relation (13.21) and we observe that based on relation (5.15), the term:

$$t_{pl} \frac{c_{0l}^3}{c_{0t}^3} = t_{pl} \left( \frac{2R_0}{r_{pl}} \right)^3 \quad (13.23)$$

Represents the total quantity of time quanta comprised in the Primordial Sphere of radius  $R_0$ .

This result reconfirms the hypothesis that the *Universal time* represents a leak of the Planck quanta of time started together with the Big Bang.

In order to calculate the dimensions of the Universe, we substitute relation (13.21) in (13.14) and it results:

$$R_{\max} = \frac{3}{2} \cdot t_{pl} \frac{c_{0l}^3}{c_{0t}^2} = 2,99 \cdot 10^{25} m \quad (13.24)$$

Following the same reasoning as in the case of time, from relation (13.24), we notice that the space represents as well a leak of the Planck quanta of space from the Primordial Sphere:

$$t_{pl} \frac{c_{0l}^3}{c_{0t}^2} = r_{pl} \frac{c_{0l}^3}{c_{0t}^3} = r_{pl} \left( \frac{2R_0}{r_{pl}} \right)^3 \quad (13.25)$$

Relations (13.23) and (13.25) are in agreement with the diagram 13.3.

The radius of the Primordial Sphere is calculated with relations (13.2), (13.19) and (13.24):

$$R_0 = \frac{R_{\max}}{2} (1 - \cos \eta_0) = \frac{1}{2} t_{pl} c_{0l} = \frac{1}{2} t_{pl} c_{0t} \frac{2r_0}{r_{pl}} = r_0 = 0,91 \cdot 10^{-15} m \quad (13.26)$$

We observe that ***the radius of the Primordial Sphere of the Universe is equal to the radius of the fundamental sphere  $r_0$  of the elementary particles.***

Using the same reasoning as in the case of time and space, we can calculate the mass of the Universe  $M_u$  as being equal to the mass of the whole Planck quanta from the Primordial Sphere:

$$M_u = m_{Pl} \left( \frac{2R_0}{r_{Pl}} \right)^3 \cong 1,2 \cdot 10^{52} \text{ kg} \quad (13.27)$$

The space-time dimensions of the actual observable Universe is calculated starting from Hubble's constant.

From relations (13.1) and (13.6), the value of Hubble's constant is calculated:

$$H(\eta) = \frac{1}{r(\eta)} \frac{dr(\eta)}{dt} = \frac{2\pi}{T_{\max}} \frac{\sin \eta}{(1 - \cos \eta)^2} \quad (13.28)$$

Knowing the value of Hubble's constant, measured in 2009 by the space telescope Hubble:

$$H_{2009} = 24,047 \cdot 10^{-19} \text{ s}^{-1} \quad (13.29)$$

And the value of the lifetime of the Universe -relation (13.22), from relation (13.28), it results:

$$\eta = 154,375^0 (2,693 \text{ rad}) \quad (13.30)$$

From relations (13.1) and (13.24), respectively (13.6) and (13.22) we obtain the observable dimension and actual:

$$\begin{cases} r_{ob, today} = 2,85 \cdot 10^{25} \text{ m} \\ T_{ob, today} = 1,13 \cdot 10^{17} \text{ s} \end{cases} \quad (13.31)$$

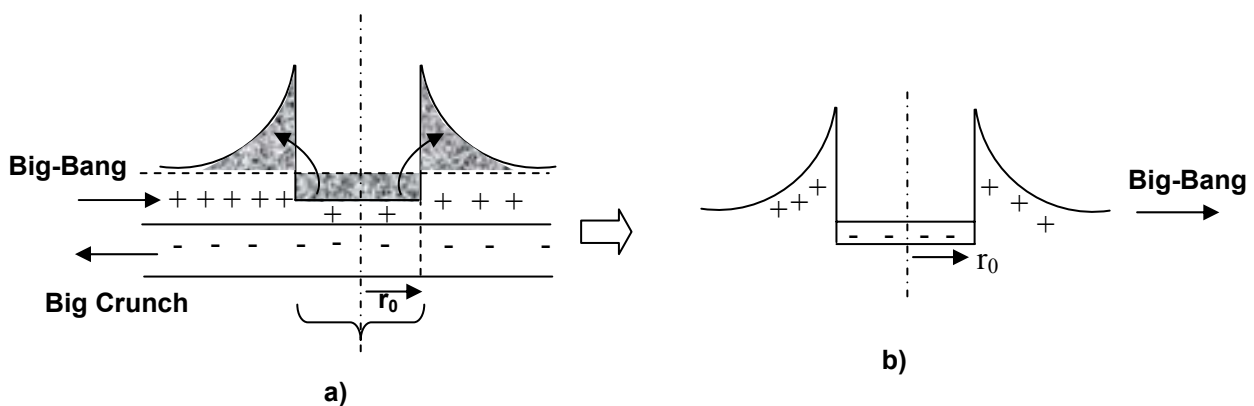
The expansion speed of the observable Universe is obtained from relations (13.28), (13.29) and (13.30):

$$v_{\text{exp}} = H_{2009} \cdot r_{ob, today} = 0,684 \cdot 10^8 \text{ m/s} \quad (13.32)$$

### 13.4. Dual Universes

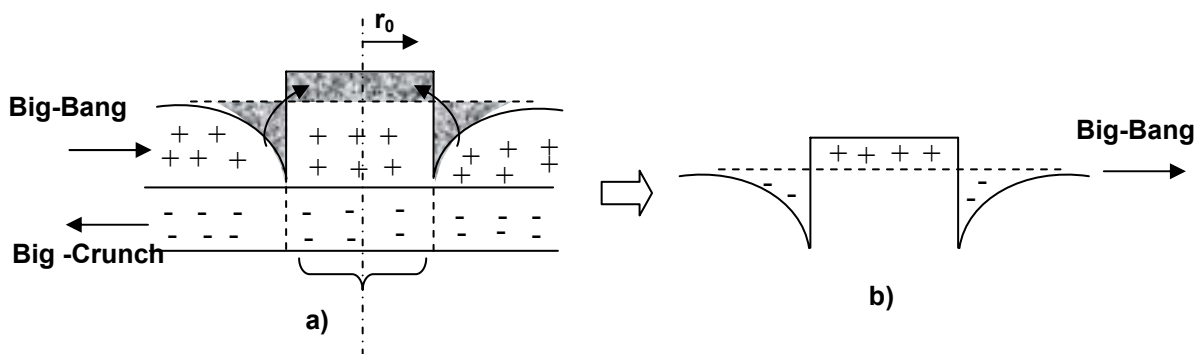
In paragraph 13.1 there has been presented the way of creation of the cyclical Universe, starting from the existence of the Universe of positive space and the Universe of negative space. In each of the two Universes there are generated elementary particles which will then become cosmic matter.

In fig 13.4-13.7 there is presented the way of creation of the elementary particles electrically charged.



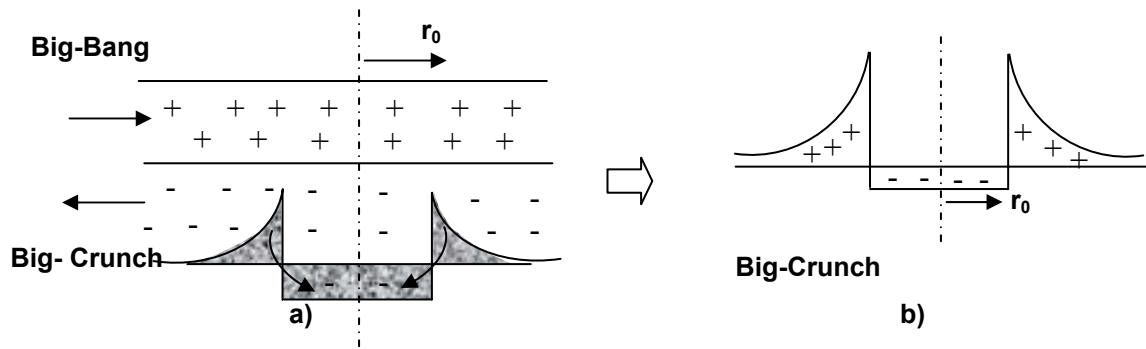
**Fig 13.4. The creation of the negative electrical charges in the Universe of positive space**

- a) the expelling of a quantum of positive space from the fundamental sphere
- b) the negative electrical charge as a local average between the two Universes

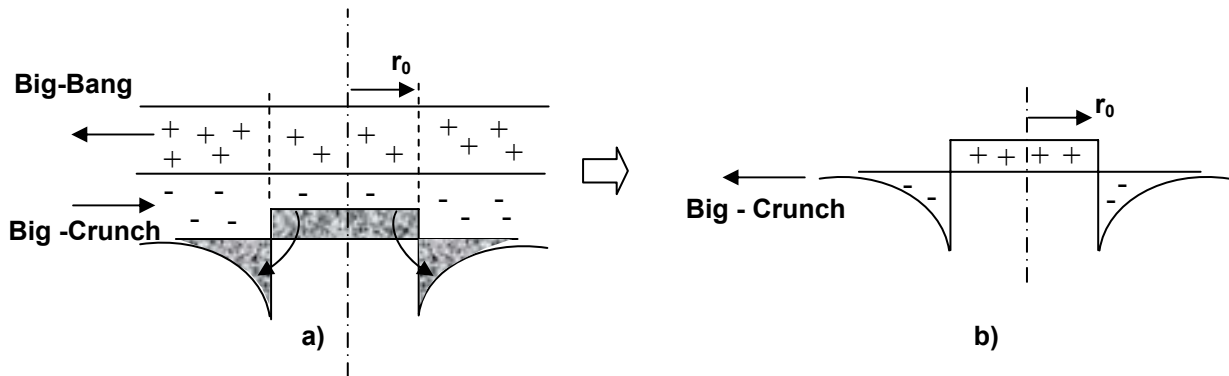


**Fig 13.5. The creation of the positive electrical charges in the Universe of positive space**

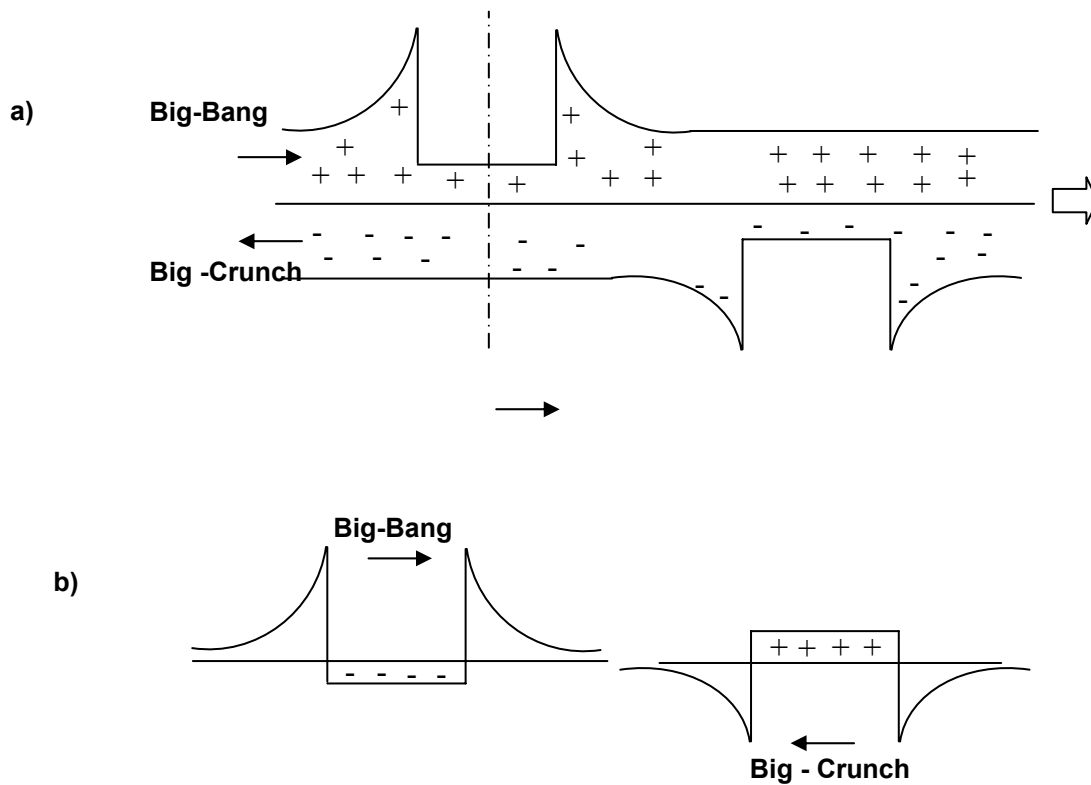
- a) the capture of a quantum of positive space in the fundamental sphere
- b) the positive electrical charge as a local average of the two Universes



**Fig.13.6. The creation of the negative charges in the Universe of negative space**  
**a) The capture of a quantum of negative space in the fundamental sphere**  
**b) the negative electrical charge as a local average of the two Universes**



**Fig 13.7. The creation of the positive electrical charges in the Universe of the negative space**  
**a) the expelling of a quantum of negative space in the fundamental sphere**  
**b) the positive electrical charge as a local average of the two Universes**



**Fig.13.8. The coexistence of the two opposite signs electrical charges in the two Universes**

**a) the creation of the opposite signs electrical charges in the two Universes**

**b) the positive/negative electrical charge as a local average of the two Universes**

By expelling a space quantum from the fundamental sphere in the Universe of the respectively space (positive or negative), an inhomogeneity is created. By local algebraic summing of the two Universes, the electrically charged particle is created.

The sign of the electrical charge depends on the Universe in which the perturbation occurs and by its character:

- expelling, presented in fig.13.4. a) and 13.7. a)
- capture, presented in fig.13.5.a) and 13.6. a).

The particles formed in the two Universes can move independently, together with the expansion of the Universe of positive space, respectively with the contraction of the Universe of negative space, fig 13.8 a) - b).

## CONCLUSIONS

- *The observable Universe has two space-time components: the universe of the positive space and the universe of the negative space.*
- *The components of the Universe have a cyclic motion shifted with half a period.*
- *The cosmic time is given by the accelerated motion of the Planck quanta of time.*
- *The physical measurable time is given by the mechanism of generation-annihilation, paragraph 10.1 and 10.3.1.*
- *Space and time are generated reciprocal and they exist outside any representation mark.*
- *The space-time dimensions of the Universe are obtained from Planck quanta of space–time only and from their properties: the velocity of the longitudinal waves and the velocity of the transversal waves.*
- *The velocity of the longitudinal waves is specific to physical phenomena that take place at Planck scale, meanwhile the velocity of the transversal waves is specific to physical phenomena that take place starting with the scale of the elementary particles.*
- *the space, time and mass of the Universe have their origin in the total of the Planck quanta of space, time and mass stored in the Primordial Sphere.*

## BIBLIOGRAPHY

- [1] Bransden B.H., Joachain C.J., *Introduction to Quantum Mechanics*, Editura Tehnică, București, 1995.
- [2] Broglie L., *La thermodynamique cache des particules*, Annales de L.I. H.I., section A, teme 1, n<sup>o</sup>1, 1964.
- [3] Chpolski E., *The Theory of relativity*, Editura Tehnică, București, 1957.
- [5] Fock V.A., *The Theory of the Space, Time and Gravitation*, Editura Academiei, R.P.R, București, 1962.
- [6] Feynman R., *Lectures on Physics, vol.I-II-III*, Editura Tehnică, București, 1970.
- [7] Ivanenko D., Sokolov A., *Classical Theory of the Field*, Editura Tehnică, București, 1955.
- [8] Jackson J.D., *Classical Electrodynamics, vol.I-II*, Editura Tehnică, București, 1991.
- [9] Klicevski N.A., *Elements of tensor calculus and its applications in mechanics*, Editura Tehnică, București, 1955.
- [10] Landau L., Litchitz E., *Thèorie de l'élasticité*, Editions Mir Moscou, 1967.
- [11] Landau L., Litchitz E., *Thèorie des champs*, Editions Mir Moscou, 1970.
- [12] Muhlin K.N., *Experimental Nuclear Physics, vol.I-II*, Editura Tehnică, București, 1982.
- [13] Ougarov V., *Thèorie de relativite restreinte*, Editions Mir de Moscou, 1979.
- [14] Onicescu D., *Probabilities and Stochastic Process*, Editura Științifică și enciclopedică, București, 1977.
- [15] Smolin L., *Three Roads to Quantum Gravity*, Editura Humanitas, București, 2002.
- [16] Vladimirov V.S., *The Physical-Mathematical Equations*, Editura Științifică și enciclopedică, București, 1980.



## SPECIAL BIBLIOGRAPHY

- [1] Mihai Gh., ***Geometrization of the Electromagnetic Field-Maxwell's Equations***, Conferinta națională de electrotehnică și electroenergetică, Craiova, 20-21 septembrie 1984.
- [2] Mihai Gh., ***Considerations of the Mode of Spreading of the Generalized Relativity Theory in Microspace***, The Forth National Symposium on Superconductivity and Cryoelectrotehnics, Craiova, November 1986.
- [3] Mihai Gh. ***Model physique-mathematique pour la description unitaire des phenomens du microcosme et du macrocosme***, The Fifth National Symposium on Superconductivity and Cryoelectrotehnics, Craiova, December 1989.
- [4] Mihai Gh., ***Des contributions a l'interpretation physique-mathematicques de l'equation de Schrödinger***, The International Conference on Applied and Theoretical Electrotechnics, Craiova, 21-23 November 1991.
- [5] Mihai Gh., ***Contributions of the Elaboration of Some Physical-Mathematical Models Regarding the Unification of the Gravity Theory with the Non-Relativistic Quantum Mechanics***, International Conference on Applied and Theoretical Electricity, Craiova, 4-6 June 1998.
- [6] Mihai Gh., ***Contributions of the Elaboration of Some Physical-Mathematical Models Regarding the Unification of the Gravity Theory with the Relativistic Quantum Mechanics***, International Conference on Applied and Theoretical Electricity, Craiova 4-6 June, 1998.
- [7] Mihai Gh., ***New Fundamental Concepts for Formulating a Determinist and Local Quantum Mechanics with Implications in the Generalized Relativistic Theory***, International Conference on Applied and Theoretical Electricity, Craiova, 17-19 October, 2002.
- [8] Mihai Gh., ***New Fundamental Concepts for Formulating the Theory of the Field Mass of the Electron and the Gravitational Theory***, International Conference on Applied and Theoretical Electricity, Craiova, 17-19 October, 2002.
- [9] Mihai Gh., ***A Physical-Mathematical Model for Analytical Calculation of the Elementary Particles' mass with Electrical Charges***, International Conference on Applied and Theoretical Electricity, Craiova 17-19 October, 2002.

[10] Mihai Gh., ***A New Physical-Mathematical Model for the Description of the Quantum Gravitation***, International Conference on Applied and Theoretical Electricity, Craiova, 14-15 October, 2004.

[11] Mihai Gh., ***The Disintegration Law of the Hyperions Loaded with Electrical Charges***, International Conference on Applied and Theoretical Electricity, Craiova, 14-15 October, 2004.

[12] Mihai Gh., ***The Magnetic Field and Maxwell'Equations Result of the Coulomb Law, Relativity and Quantum Mechanics***, Annals of the University of Craiova anul 30, nr.30, 2006.