

# **Ball Lightning, Micro Comets, Sprite-Fireballs, Solar Bright Points and X-ray/Gamma Flashes according to Quantum FFF theory.**

Leo Vuyk,  
Architect,  
Rotterdam, the Netherlands.  
[LeoVuyk@Gmail.com](mailto:LeoVuyk@Gmail.com)

## **Abstract,**

FUNCTION FOLLOWS FORM in Quantum FFF THEORY.

The FORM and MICROSTRUCTURE of elementary particles, is supposed to be the origin of FUNCTIONAL differences between Higgs- Graviton- Photon- and Fermion particles. As a consequence, a NEW splitting, accelerating and pairing MASSLESS BLACK HOLE, able to convert vacuum energy (ZPE) into real energy by entropy decrease, seems to be able to explain quick Galaxy- and Star formation, down to Sunspots, (Micro) Comets, Lightning bolts, Sprites and Elves, Sprite Fireballs and Ball Lightning. Recently the NASA-SOHO satellite photos showed clear evidence of multiple hotspots created at the solar surface. I assume that the majority of the hotspots can be compared with Micro Comet- or fireball phenomena related to Sprites..

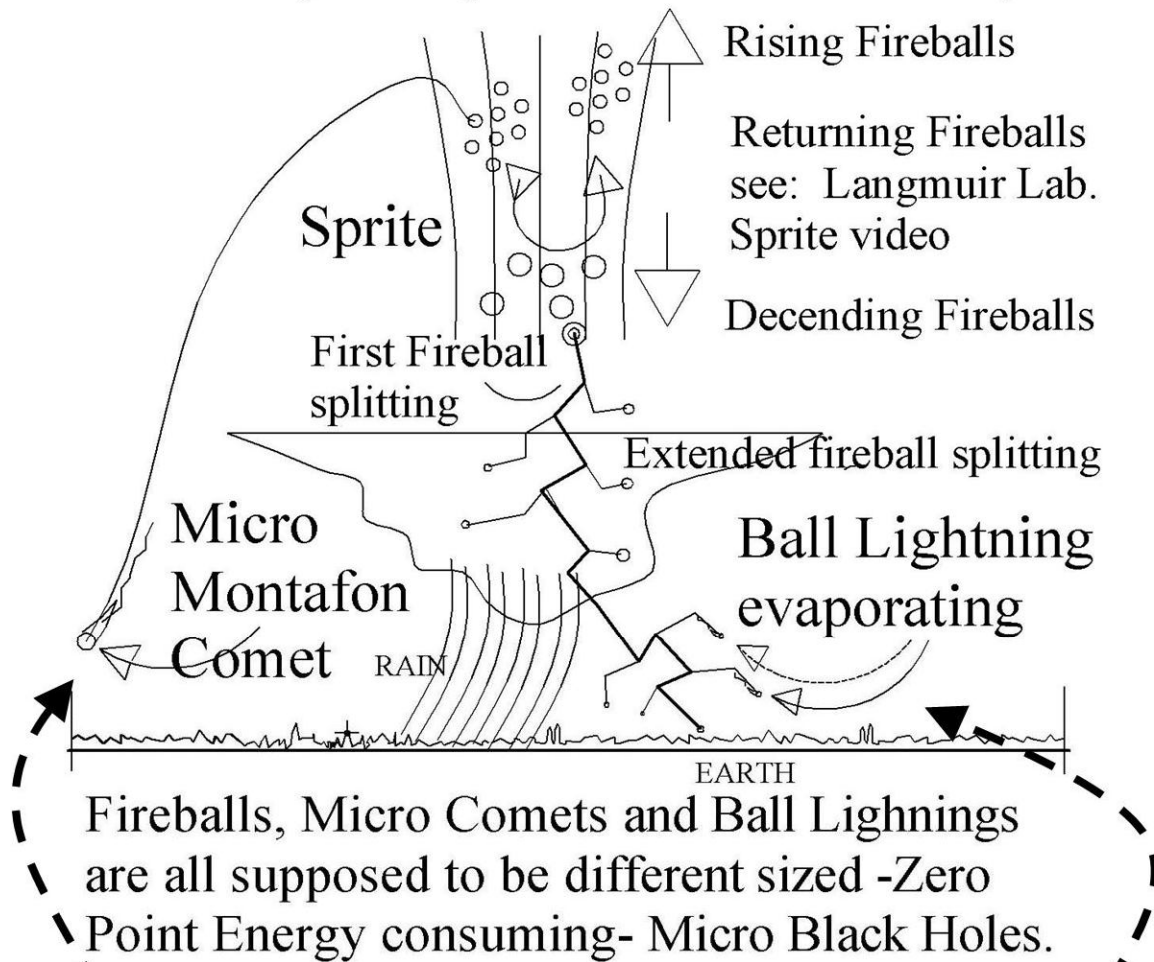
## **introduction.**

Quantum FFF theory states, that the vacuum is seeded with fast oscillating massless Higgs particles, oscillating along a complex chiral tetrahedral vacuum lattice, which has the ability to transfer Photon and Graviton FORM information in bunches of oscillations, through the vacuum lattice with the local speed of light. Ref [5,6,8,9]. As a consequence there are no attraction forces on propeller shaped Fermions. Gravity seems to be the result of two different impulse arrays: the massless Higgs impulse array and the (less effective) massless Graviton impulse array. As a consequence Black holes suffer only Higgs impulses and NO gravitons are escaping because the nucleus of the black hole is supposed to be a super dense knot of Higgs particles. (Ref. 2). Only the statistical sum of the different kinds of vacuum impulses from all directions on Fermions are responsible for all (energetic) phenomena in the universe. Ref.[1,2,3,4,9] the Q-FFF alternative for Feynman diagrams.

The accelerating plasma tail of NEW paradigm black holes (Ref.1,4), and the splitting black hole, is supposed to be the origin of a smooth proliferation of black holes in the universe and Gamma ray Bursts (GRBs). The Eagle Nebula, (figure: 10) seems to be a great example of a smooth proliferation of black holes by the splitting of black holes through Galaxies and Nebula.

In this letter, we present a comparable system of splitting black holes on the micro scale related to Sprite fireballs and Lightning bolts. Recently the NASA-SOHO satellite photos showed clear evidence of multiple hotspots created at the solar surface. I assume that the majority of the Solar hotspots can be compared with Micro Comet- or fireball phenomena related to Sprites..

Production hypothesis for Ball Lightning and Micro Comets on Earth, according to Quantum FFF theory. 12-April 2011. Author Leo Vuyk.



Two observations as a support for the theory..

Figure 1, simplified representation of the relation between the creation of Fireballs inside Sprites and Lightning strokes with the resulting fireball effects on Ball lightning and Micro Comets as is found in Austria (Montafon area) by Werner Burger.

Werner Burger reported: some raindrops fell thunder storm was far away. A strong support for the hypothesis that Sprites located at the top of heavy Thunderstorms produce Fireballs (micro black holes), which can travel over long distances and present themselves as micro Comets or Ball lightning far away from the Thunderstorm.

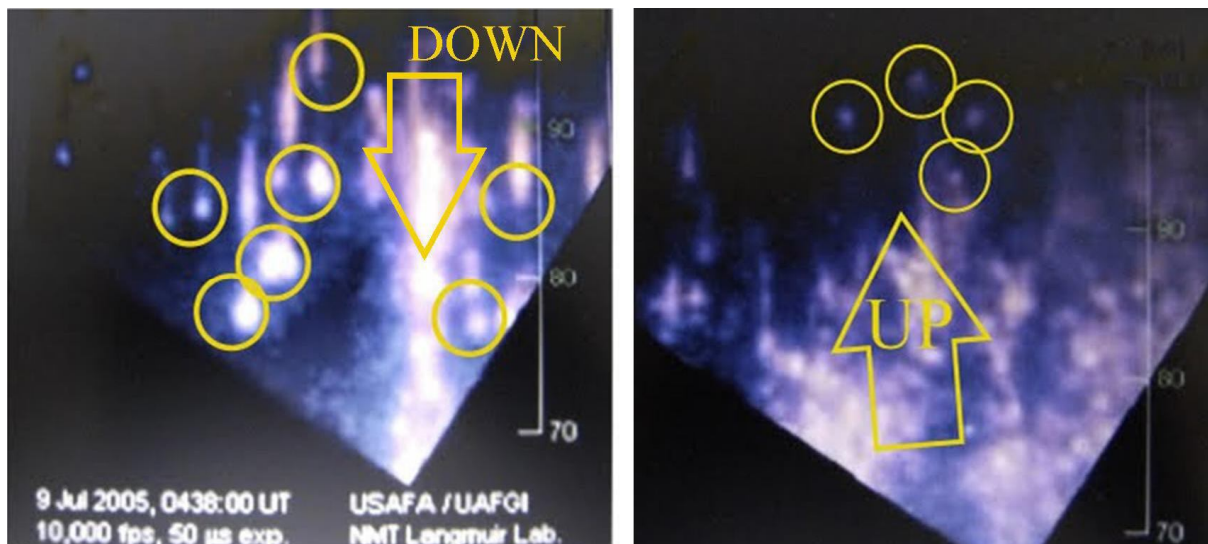


Figure 2, FIREBALL images observed inside a Sprite by a video. The video is made by a High speed camera (10.000 f/sec) of the Langmuir laboratory (USA, 2005) looking at 70-120 km altitude.

Left side: Fireballs are rapidly falling, right side and with only micro seconds delay, smaller Fireballs are rising.



Figure 3, Micro black holes, splitting and evaporating at the top of the lightning leaders, sometimes assumed to evolve into a ball lightning.

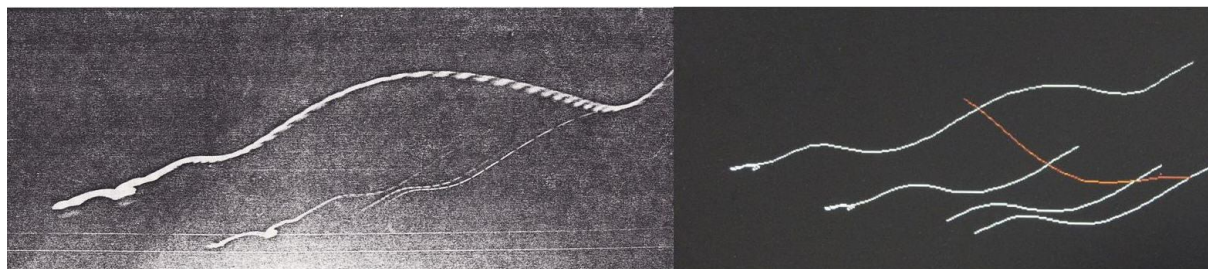


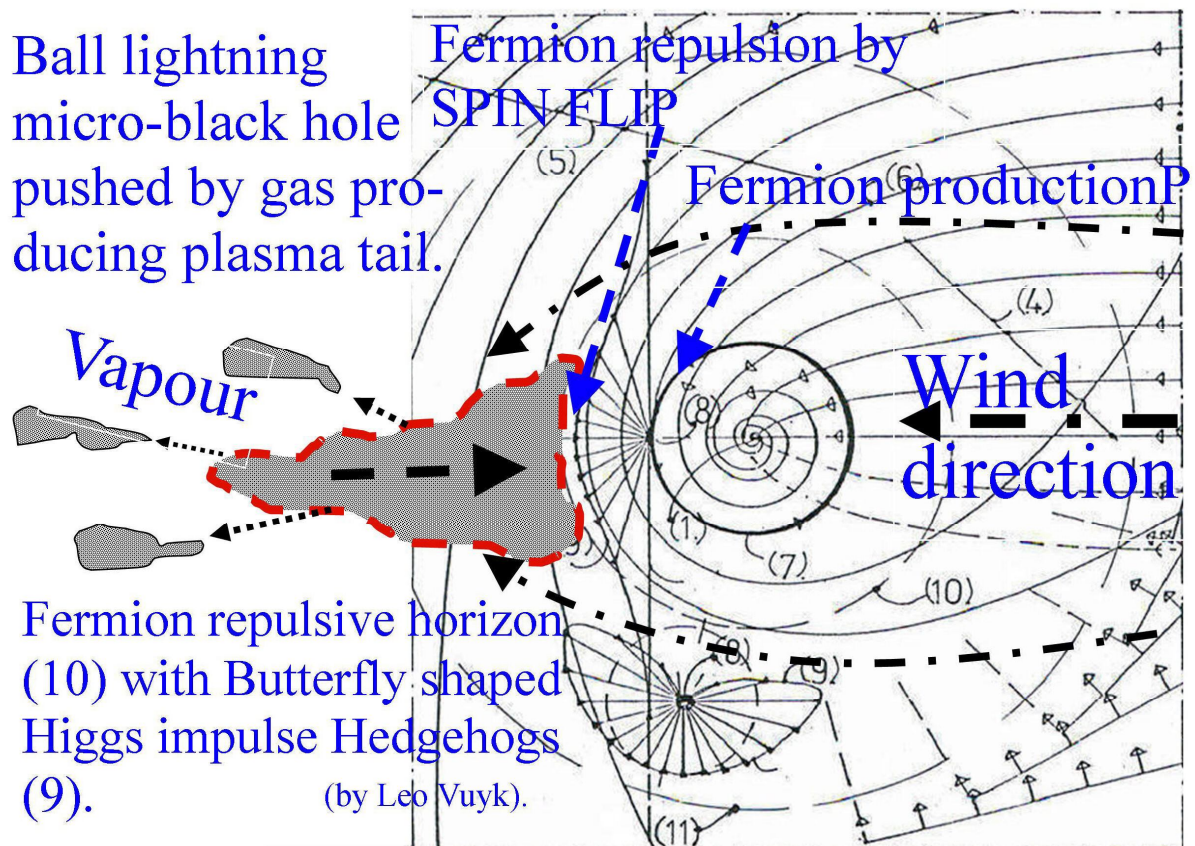
Figure 4, Example of micro black hole production possibly by strong electromagnetic or x-ray interference at sea level. There are four traces to be observed with comparable waveforms. ( see also at the right side: reconstruction image). The left photo is made by Mr. Overhagen (the Netherlands) by automatic shutter camera through his roof window, during heavy thunder storm. The two bumps at the end of two waveforms could be the start of the formation of a micro Black hole.

The same formation process is supposed to be active inside Sprites by the formation of Fireballs observed in the Langmuir videos (Figure 2).



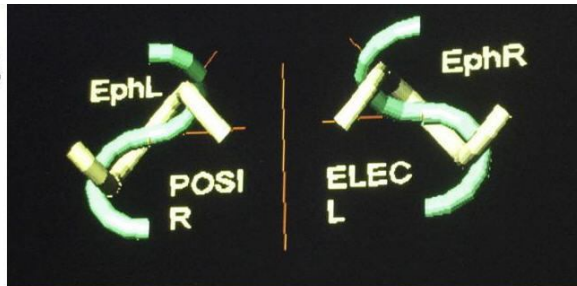
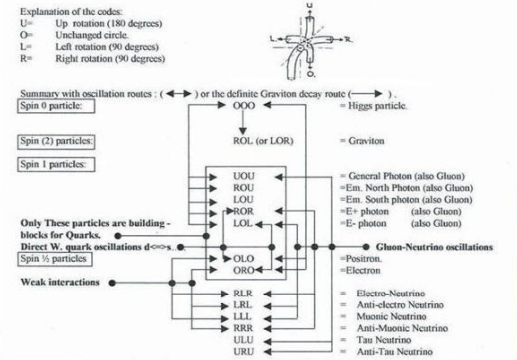
**Figure 5, Photo of a Ball Lightning made in Japan.**

Why is it that Fireballs inside sprites go down and UP again? The reason must be found in the comparison with Ball lightning qualities on earth, they seem to be pushed by plasma tails.

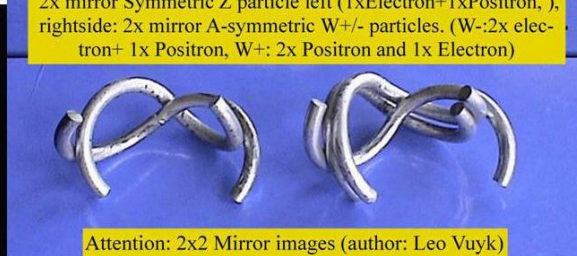


**Figure 6, It is assumed that the New Paradigm Black hole is able to use and accumulate so called "Zero Point Energy" to form Plasma tails which seem to be able to push the black hole away from the centre of mass of the earth. (Ref. 4 )**

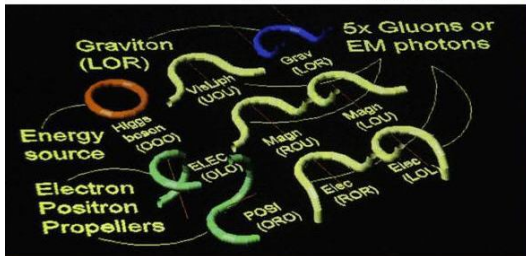
**ALTERNATIVE STANDARD MODEL**  
of elementary (single) particles with click-on potentials to form compound Quarks- and Leptons. (author Leo Vuyk)



2x mirror Symmetric Z particle left (1xElectron+1xPositron, ), rightside: 2x mirror A-symmetric W+/- particles. (W-:2x electron+ 1x Positron, W+: 2x Positron and 1x Electron)



Attention: 2x2 Mirror images (author: Leo Vuyk)



The alternative standard model with some 3-D examples of different particles?

Figure 7, the alternative standard model ref. [5]

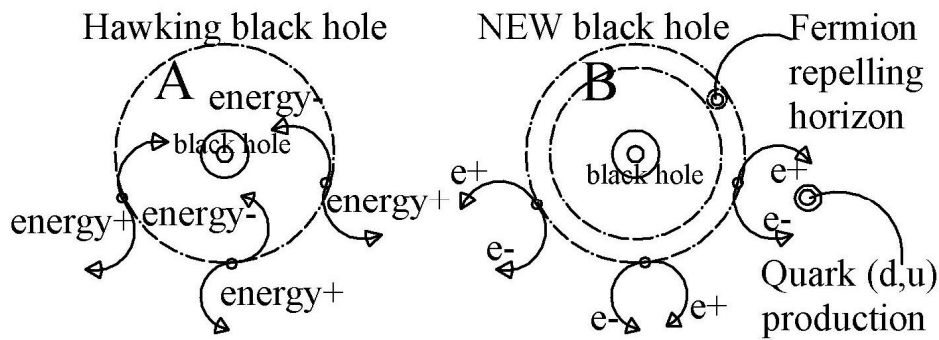
## The Nucleus of the NEW Black Hole.



A ball of Stringy particles compressed by the oscillation energy of the NEW Higgs vacuum Lattice= DARK ENERGY. The BH Nucleus itself is DARK MATTER.

Figure 8, The NEW micro black hole nucleus is supposed to contain only a small number of Higgs particles. Ref [4]

# The NEW Black Hole Paradigm



The standard Hawking Radiation postulate is: that all matter ( NOT all energy) is drawn into the Black hole.

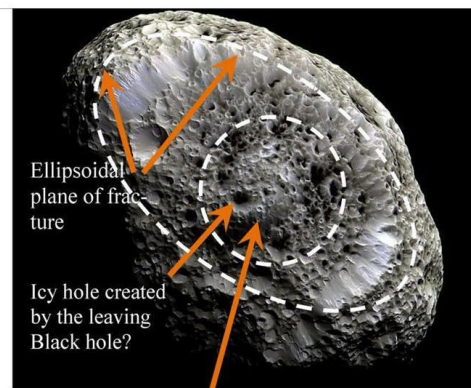
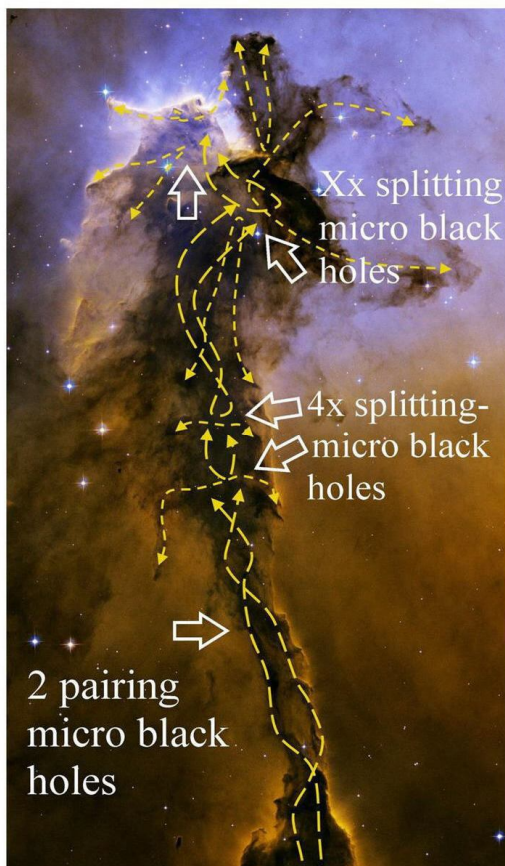
My NEW postulate is that matter is created (and pushed outside) at the Black hole horizon by QUANTUM FLUTUATIONS producing electrons and positrons.

Some electrons and positrons will annihilate, but the rest will form Quarks and plasma, because the Higgs vacuum lattice is CHIRAL and prefer to link gluons to positrons. Thus more electrons will stay single and form atom shells!

Due to the propeller shape of the particles all the plasma is repelled away from the black hole!! The black hole will not evaporate !

This is the base for NEW Physics and a support for a new explanation of Cometary X-rays, Hydrogen and AMINO ACID production. Even Gas Pillar and Herbig Haro formations inside Nebula become a logic base. Author Leo Vuyk.

Figure 9, Principle of the new black hole paradigm.



Hyperion's globular inner nucleus is a firm indication of entropy decrease at the boundary between Higgs repulsion and attraction zones (4) around NEW (micro) black holes.

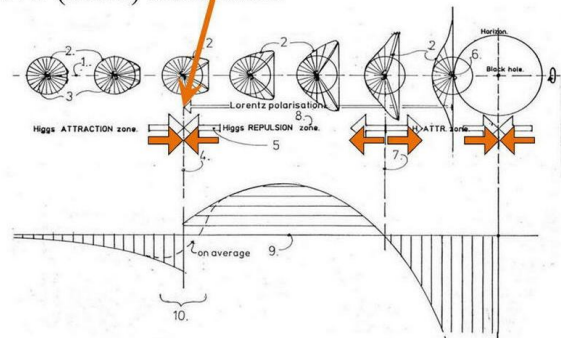
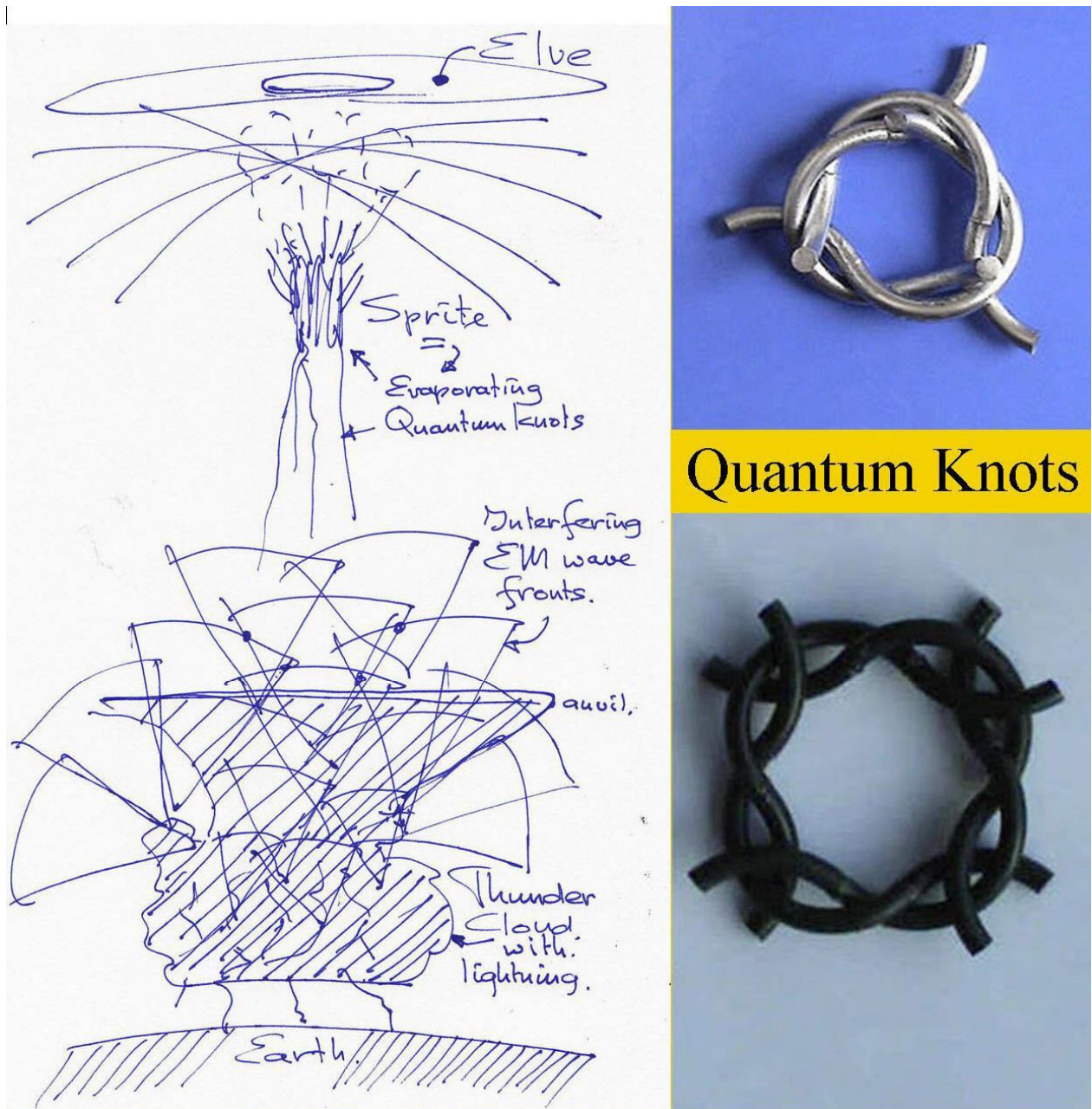


Figure 10, Comparison with splitting and pairing Micro black holes inside Planetary nebula, and the formation of comet nuclei like the Hyperion icy nucleus.

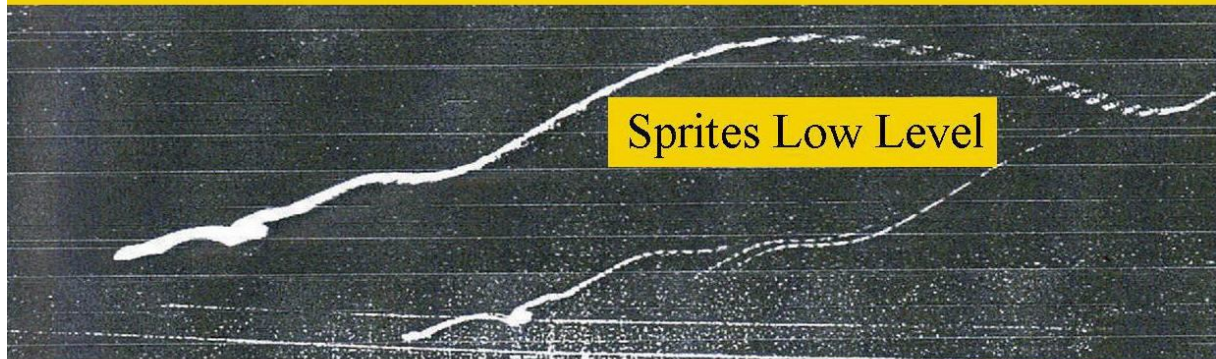
It is assumed that so called Universal Gamma ray Bursts are produced by the splitting of micro or mini-black holes in space, such as inside Planetary Nebula. (figure 10) **Ref [4]**.



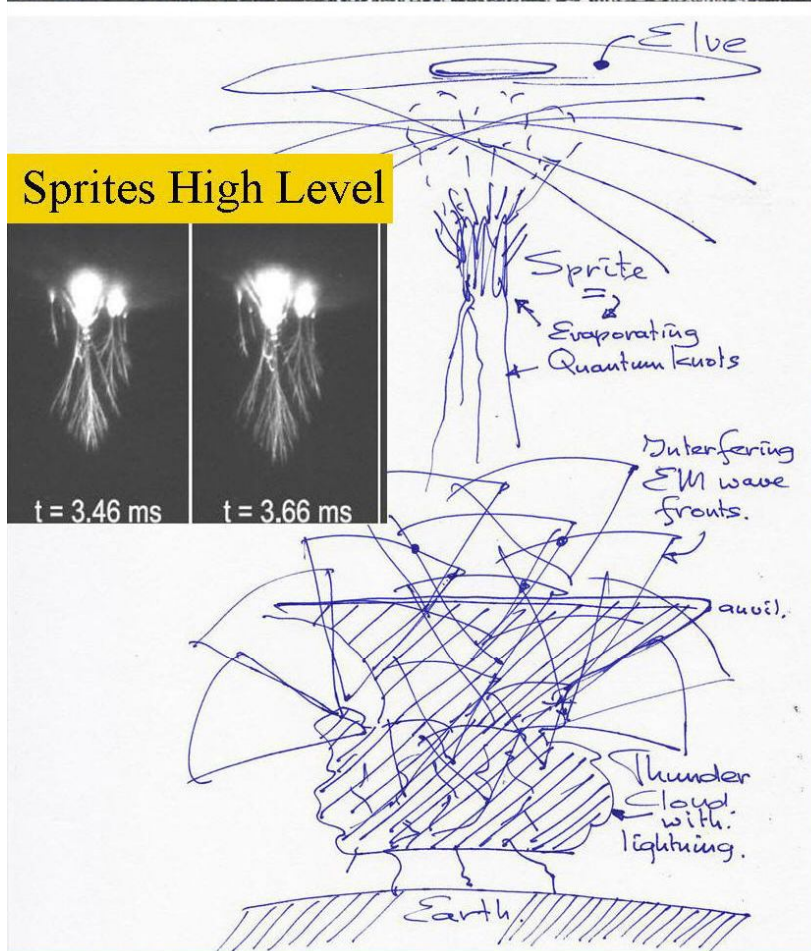
Quick evaporating Quantum Knots as the origin of Sprites and Elves at high altitudes ( 50-100 km). According to Quantum FFF theory, Electro magnetic wavefronts (photons) are in special geometrical cases like Silicon crystal structures, able to form Quantum KNOTS. These knots are supposed to be unstable nano black holes.

Figure 11. Sketch of the Sprite Elve system related to Thunder clouds and interfering EM wavefronts into small and larger Quantum Knots. In the middle of the Sprite however there is real micro comet and Ball lightning forming observed, representing more stable Quantum Knots or micro dark matter based Black Holes.

# Quick evaporating Quantum Knots.



Sprites Low Level



Sprites High Level



Quantum Knots



Quick evaporating Quantum Knots as the origin of low level Sprites (roof top) and High level Sprites and Elves at 50-100 km altitude of short duration. According to Quantum FFF theory, Three or Four Electro magnetic wavefronts, are in special geometrical cases, able to form Quantum KNOTS by a geometrical interference process. (see: 2x different shaped particle knots) These knots are supposed to be quick evaporating unstable nano black holes.

Figure: 12, Sprites: Quick Evaporating interference Quantum Knots (Micro/Nano Black Holes) the origin of Ball Lightning (photo: W.H. van Overhagen Oegstgeest 1991, printed in KIJK aug 1993)



Production hypothesis for Quantum Knot Ball Lightning by Interference, Micro Comets, "Dark gamma Lightning" and Sprites, based on Photos and Langmuir fireball videos and Quantum FFF Theory 01-09-2013.

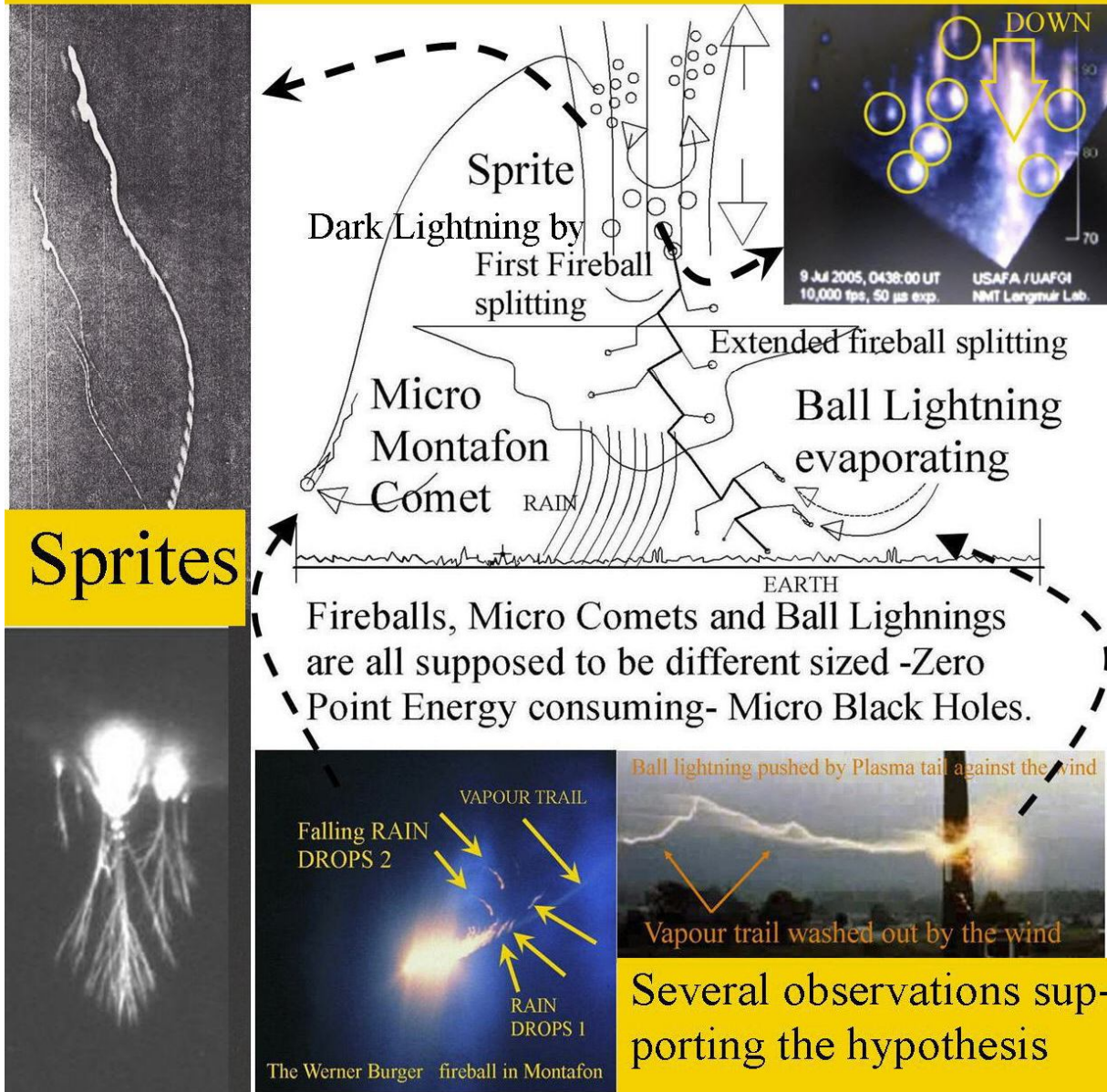
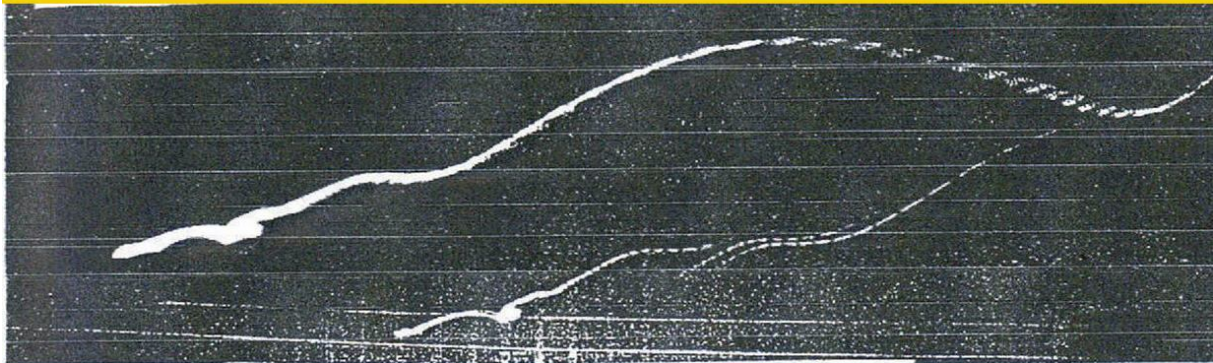
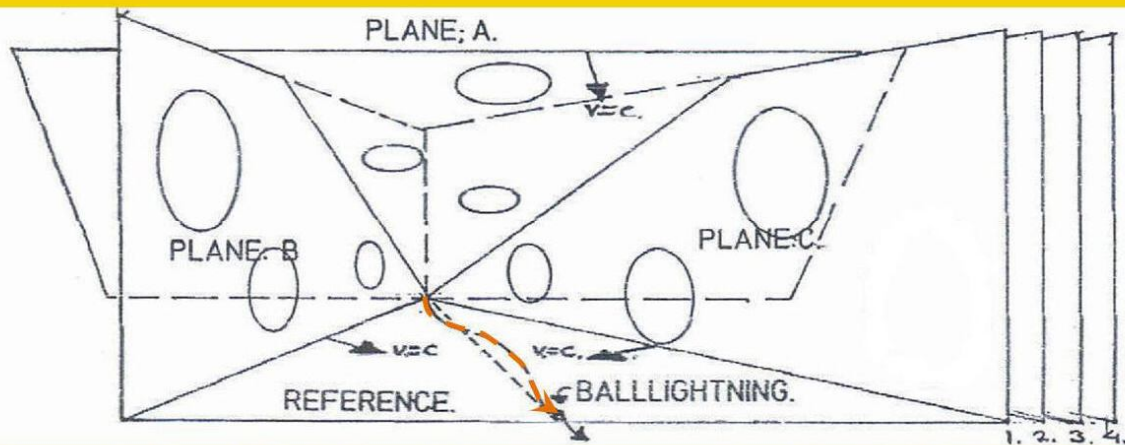


Figure: 13, Several examples of Quantum Knot Ball Lightning created by electro magnetic Interference, Micro Comets and Sprite fireballs combined with Gamma ray "Dark lightning".

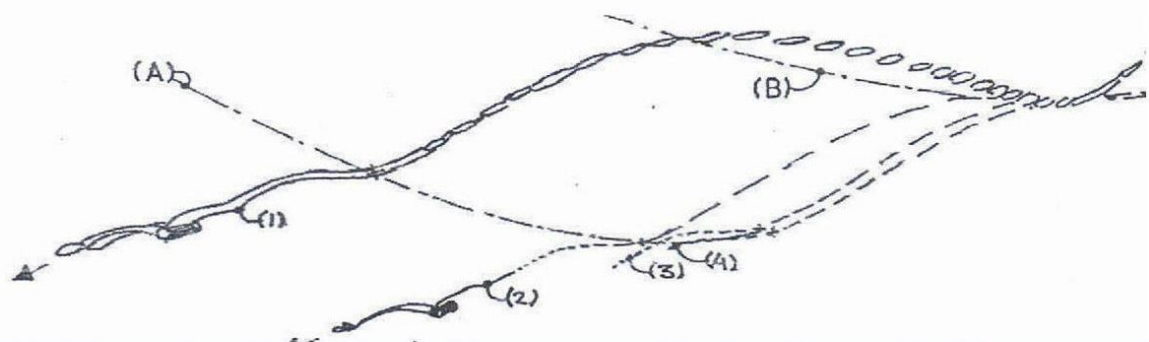
# Birth of EM interference based Ball Lightning or micro Black Hole. ( Quantum FFF Theory)



Birth of EM interference based Ball Lightning or micro Black Hole. (Photo: W.H. van Overhagen 11 aug 1991 during thunderstorm from roof window, the Netherlands)



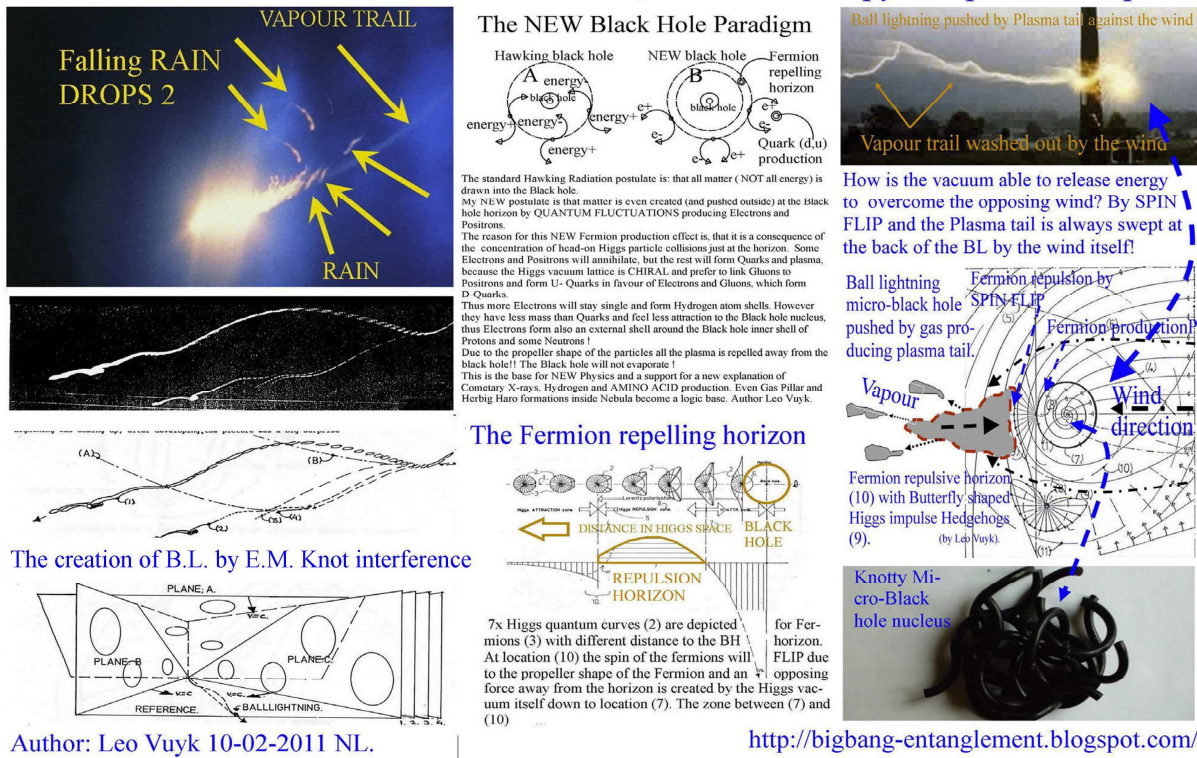
Theoretical model of the origin of 4x separated trails of light, by three interfering but repeating (1-4) wavefronts.



Dashed lines ( A and B) connect four corresponding bending points. Two traces (1 and 2) produce plasma balls (Ball Lightning) which seem travel on its own.

**Figure: 14** The start of my Quantum Knot interpretation of Ball Lightning and other Black Holes, came to me by this photo.

**THE SECRET OF BALL LIGHTNING. Its production by e.m.- x-ray interference into a KNOTTY Nucleus, able to accelerate, decrease Entropy and produce Vapour.**



Author: Leo Vuyk 10-02-2011 NL.

<http://bigbang-entanglement.blogspot.com/>

**Figure 15, The start of my research was: Ball Lightning physics. Such as Quantum Knot-interference BLs and the origin of acceleration of Knotty BL micro black holes (Quantum Knots) by pushing plasma tails.**

It was recently confirmed, that strong Terrestrial Gamma ray Flashes (TGFs) were related to Sprites! **Ref [12]**

This seems to be a strong support for the postulate that Fireballs inside Sprites are related to micro black holes.

Professor Joseph Dwyer was the first who found that x-ray flashes were connected to the splitting of stepped leaders of lightning strokes. **Ref [13].**

This seems to be a strong support for the postulate that stepped leaders of lightning, are produced by splitting micro black holes.

Dwyer's main conclusion: As the lightning comes down from the cloud toward the ground in 30- to 160-foot stages known as "steps" in a "step leader" process, the X-rays shoot out just below each step, mere millionths of a second after the step completes!!

Less Is More” and “Form Follows Function”.

The Aphorisms: “Less Is More” and “Form Follows Function”, of Modern Architecture, introduced by Mies van der Rohe respectively Louis Sullivan, seem to be REVERSIBLE in Nature.

Why, because at the Planck scale, the FORM of particles and the way particles are able to connect to each other and form compound quarks, seem to be the origin of the particle FUNCTION.

As a result we may say: FUNCTION FOLLOWS FORM in particle physics and beyond, because it seems that the fermion form is also the origin of Fermion repulsion (spin flip) at the black hole horizon.

At the Universal scale however, CPT ( Charge, Parity and Time) SYMMETRY between entangled copy Universes, forming a Multiverse with Raspberry geometry, seems the most logical solution for a theory of everything. (ref 3).

### **QUANTUM FFF Theory.**

New Physics by the architecture of Quantum FFF (Function Follows Form)Theory.

Characteristics:

1: The clear MICROSTRUCTURE or the 3D FORM of elementary particles, (also called 3D-Preons) made out of convertible Higgs particles, is responsible for “Bound states of Fermions” and composite Quarks.

2: The Higgs is supposed to be energetic oscillating, it is the origin all particle motion and spin states and Dark energy (125 GeV) inside a truncated tetrahedron shaped chiral vacuum lattice. The lattice chirality (left or right handed) is the origin of our material universe. Higgs particles are zero point “Planck Oscillators” the origin of the Casimir force, waiting to be harnessed as free energy.

3: NOTHING SUCKS IN PHYSICS, Gravitons act with less pressure on Fermions than the Higgs vacuum (dark energy) and everything is ENTANGLED by INSTANT communication between at least two anti-copy UNIVERSES or MULTIVERSE, being entangled since the big bang.

4: Black holes of all sizes (down to ball lightning) do not emit gravitons, they feel only Casimir Gravity of the vacuum oscillations so they are massless but counter intuitively the origin of dark matter and producers of all Hydrogen by electron and Positron pairs as horizon fluctuations and repel all Fermions at the BH horizon.

5: The Multiverse is Pulsating by two phenomena, A; vacuum (Higgs) eating new paradigm dark matter black holes (causing the Hubble redshift) and B: by universal expansion caused by the oscillation force (Dark energy) of the Higgs vacuum lattice.

FUNCTION FOLLOWS FORM in Quantum FFF-Theory. The Microstructure of elementary particles, is supposed to be the origin of FUNCTIONAL differences between Higgs- Photon- and propeller shaped Fermion particles. Something SMALL is missing in mainstream physics: a NEW splitting and pairing MASSLESS BLACK HOLE, the origin of all dark matter, Ball Lightning Micro Comets , Comets, Sunspots up to Galaxy external Anchor Black Holes and the Big Crunch of the CP symmetric pulsating raspberry shaped multiverse.

The multiverse is a huge pinball machine, with dark energy in the form of linear oscillating double Higgs pins as the origin of photonic collision products with the propeller shaped Fermions as balls. All forces are the result of this entangled Pin-Ball interaction. The 125GeV Boson recently found in the LHC is not a single but a double massless 3rd generation Higgs boson linear oscillating in tandem as opposing boxer engine pistons in a chiral truncated

tetrahedron lattice. The 125GeV energy is the base for universal dark energy, the frequency is the base for local time and the length a base for the Planck scale. (Twin Higgs, Dual Higgs, Duplex Higgs, or Tandem Higgs) AS A RESULT, Free energy devices and electron-muon decay levitation is proposed. An unstable Higgs vacuum seems to be present around all black hole horizons by observed H<sub>2</sub> production and annihilation radiation created by pair production of positrons and electrons. (Instability of the Higgs field) see: [http://vixra.org/author/leo\\_vuyk](http://vixra.org/author/leo_vuyk) <http://www.lulu.com/spotlight/LeoVuyk>

Keywords: Dark Matter Black Holes inside Sunspots, Comets, Ball Lightning, outside: Stellar-, GalaxyAnchor Black Holes. (Origin of universal contraction). Dark Energy Higgs vacuum lattice, the origine of universal expansion. Dense aether model. Black Hole Casimir Gravity, Quantum knots. Einstein metrics with constant scalar curvature, 2-Higgs doublet model. (2HDM MODEL) Solar Bright Points, Leo Vuyk.

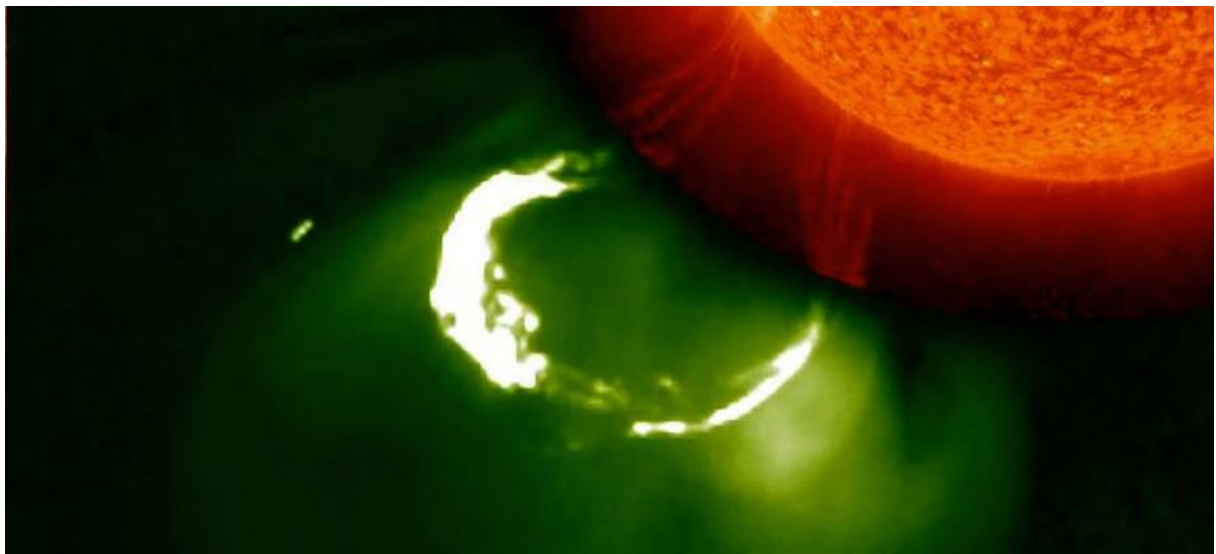


Figure: 16, Fireball production of the sun, leading to micro Comets comparable to Sprite fireballs on earth .

---

## Conclusion,

The described observations related to Sprites, Elves and Lightning phenomena are a strong support for the new Black hole ( Quantum Knot) paradigm of Quantum FFF theory described in references [1-9] and in figure 11 .

The production of Fireballs inside Sprites is supposed to be the start of all stepped lightning leaders and micro Comets, after a splitting process of the Sprite Fireballs into smaller sized micro black holes.

This process is supposed to produce the Terrestrial Gamma Flashes. (TGF)

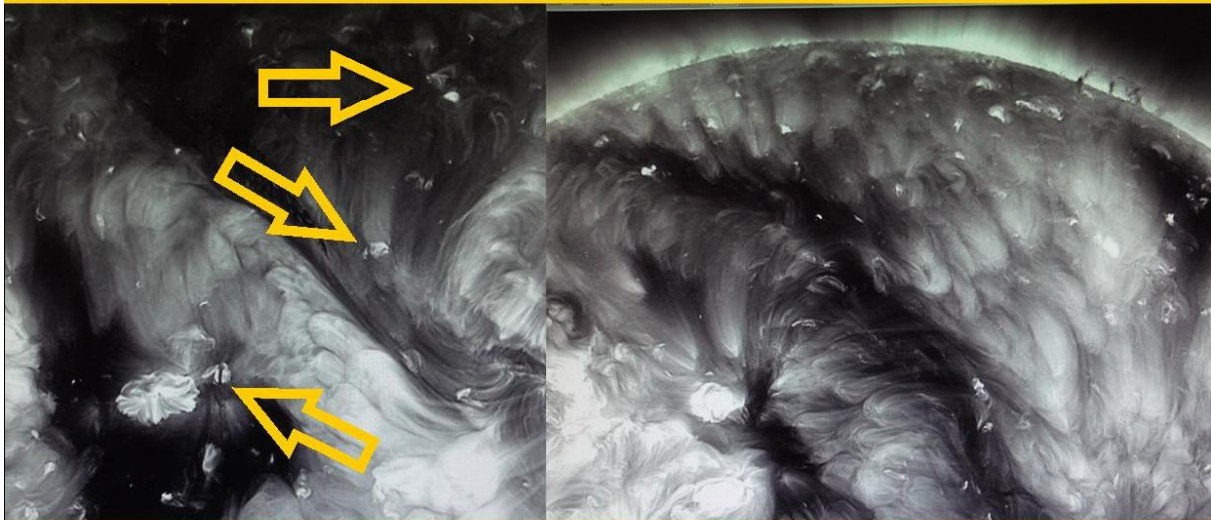
Some of these smaller reduced Fireballs seem to be able to rise again, pushed by plasma tails and become so called micro Comets forming an icy crust around the nucleus.

By forming more and more ice, the weight of the micro comet will increase.

After the weight becomes in equilibrium with the pushing power of the plasma tail, the Micro Comet will start to fall down to earth, like the Montafon Comet seems to do. ( Fig. 1)

The rest of the reduced Sprite Fireballs seems to be unable to form plasma tails and are supposed to be the origin of x-ray emitting hotspots of the stepped leaders going down.

According to Quantum FFF Theory, Sunspots are supposed to be dual systems of former Comets (or better micro black holes) responsible for the so called “Coronal Cells” or “Bright spots” found at the solar surface and for solar convection. These Bright spots are supposed to represent newly formed Magnetic interference micro black holes, just like interference fireballs observed in Sprites on earth. <http://arxiv.org/pdf/1403.0692.pdf>



If dual systems of micro sunspots have a vertical orientation to the surface, it is assumed to accelerate convection and interference processes. Astroids observed in the Oort cloud, the Kuiper belt and inner astroid belt, are supposed to be the result of the expelled solar Micro black holes.

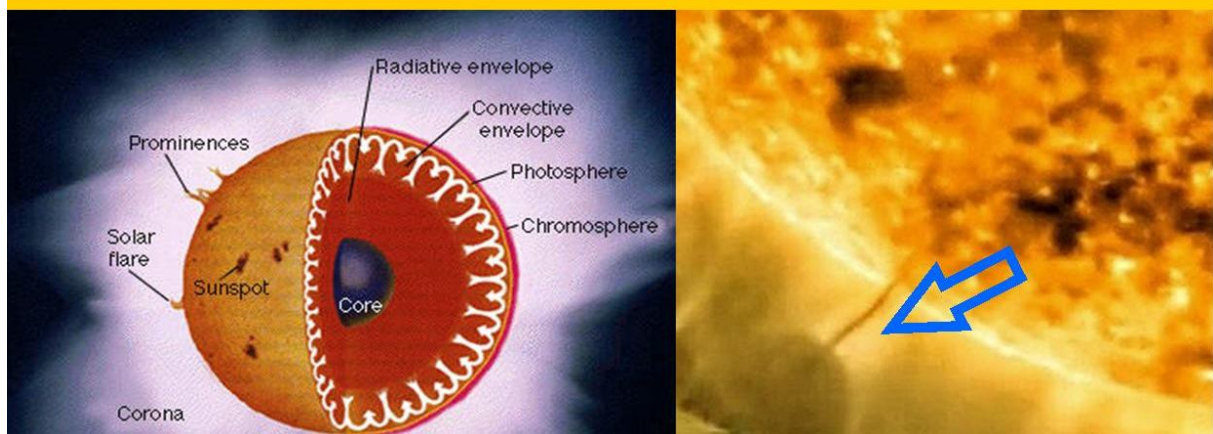


Figure: 17, ( see also ref. [13]) Bright points or spots at the solar surface represent small Comets able to leave the sun by new pushing Cometary tails like Ball Lightnings do. The origin of these bright points are supposed to be so called “Interference black holes” according to Q-FFF theory.

Micro black hole based Comets produce H<sub>2</sub> and Water molecules building the icy Comet nucleus, spouting icy dust tails. Semi-Stationary Cometary objects ( P2013 P5) should be located all over the solar system, in the Oort cloud, the Kuiper belt and inner astroid belt, according to Quantum FFF Theory.

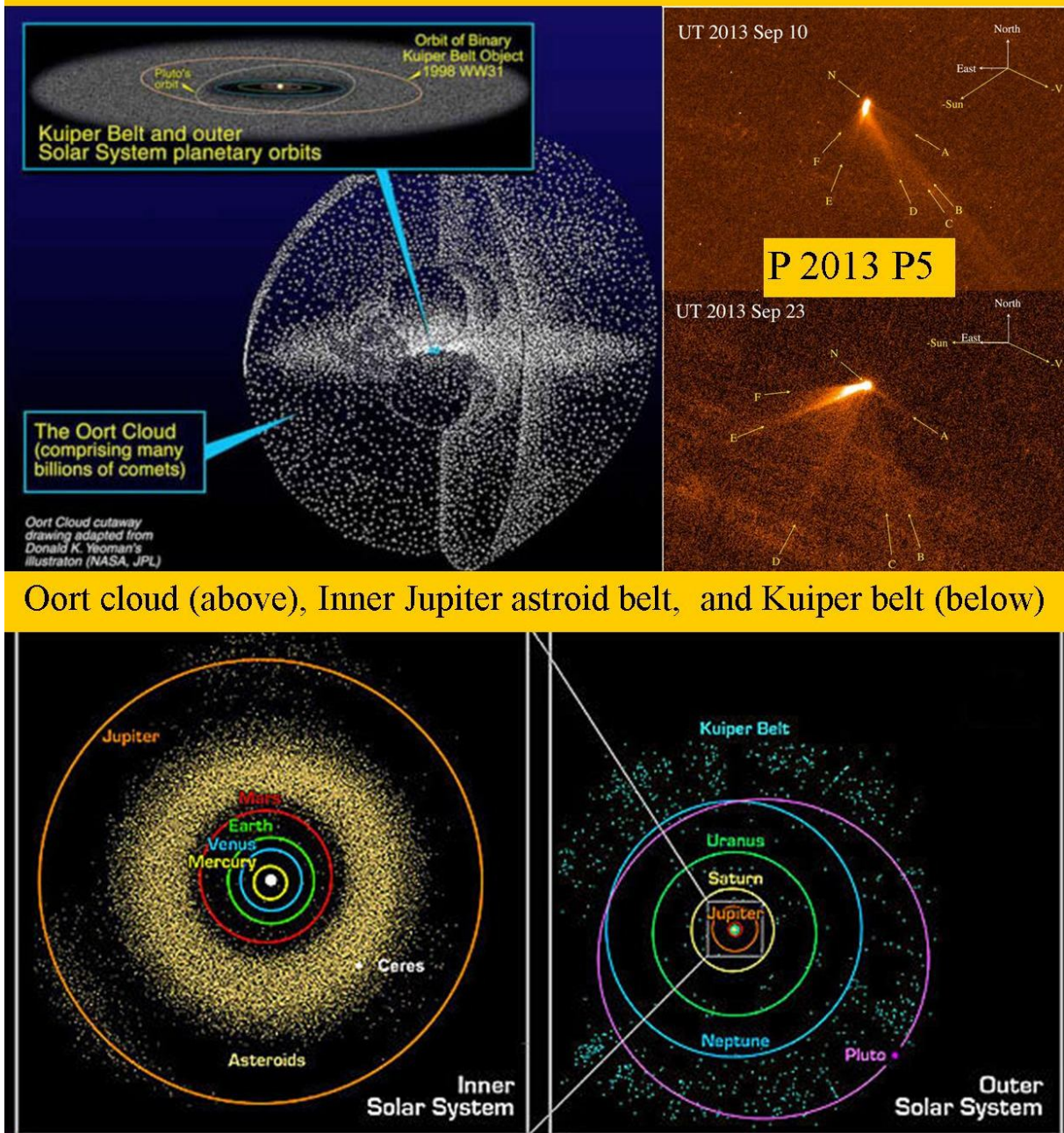
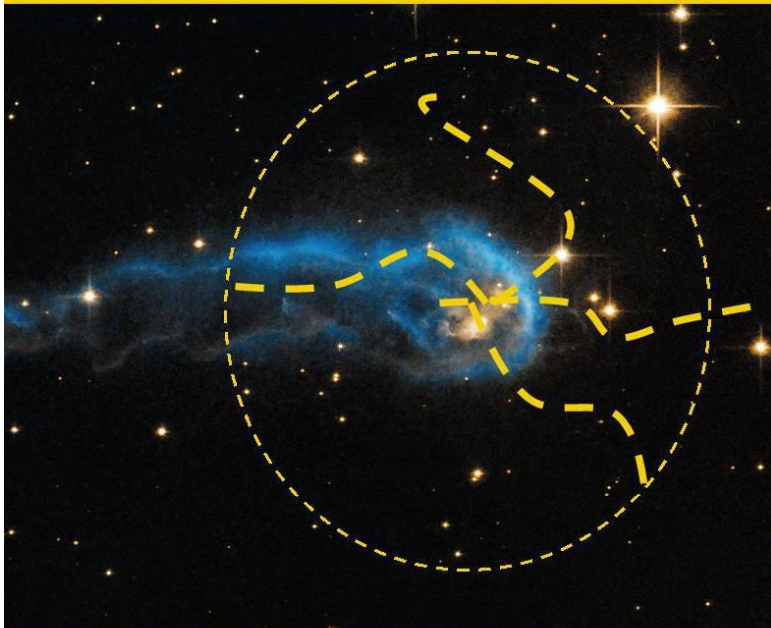


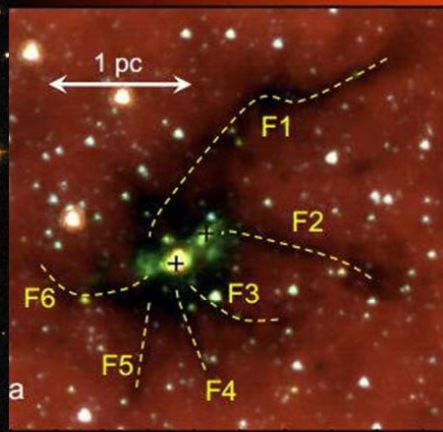
Figure: 18, The solar baby comets are supposed to travel onto the different clouds or belts like the Oort cloud and Kuiper- and Inner Jupiter belt.

The future of the Tadpole or Caterpillar Nebula according to the new paradigm Black Hole pairing and splitting /receding process of Quantum FFF Theory.

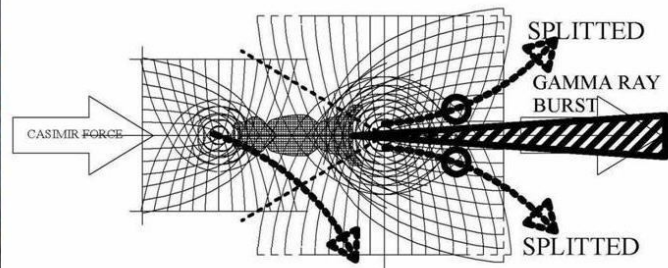
The tadpole nucleus is assumed to form a “Multiple Herbig Haro system”, (gas cloud filaments, as observed in SDC 335, 1,-6) as a start for fast massive star formation and an open star cluster.



SDC 335 with gas filaments as multiple Herbig Haro objects



The Nucleus of the Tadpole nebula seems to be a combination of different- and medium sized black holes. According to Q-FFF theory this is a base for “Black Hole Splitting” by a collision process with a so called Gamma Ray Burst as result.



The multiple nucleus of the Tadpole nebula and the Q-FFF principle of the black hole splitting process with GRB burst as a result

Figure: 19, A possible second origin of Gamma Ray Bursts in space is the so called Black Hole Splitting process of different sized black holes. As described in Vixra essay nr: 1304.0022. The Self Organizing Universe in the Carina Nebula.

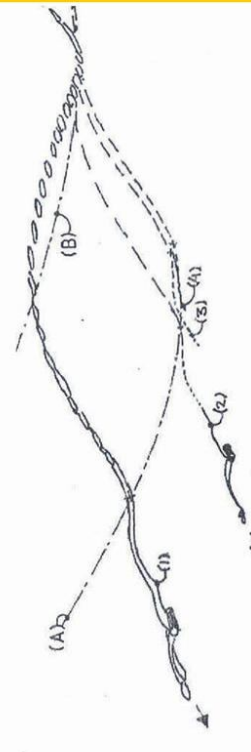
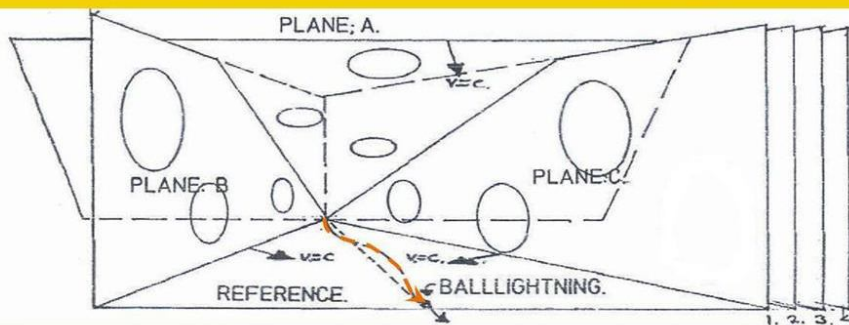


# Electric Dark Matter Black Hole Ball Lightning and icy remnants (Megacryometeors)

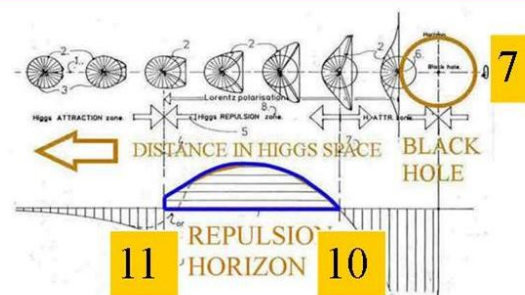
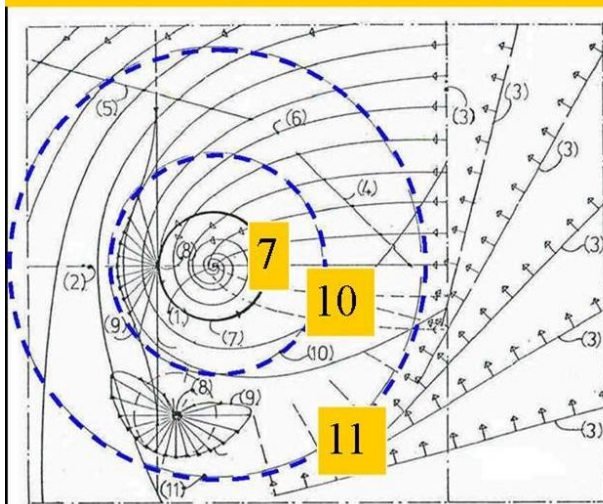
Birth of EM interference based Ball Lightning or micro Black Hole. ( Quantum FFF Theory)



Birth of EM interference based Ball Lightning or micro Black Hole. (Photo: W.H. van Overhagen 11 aug 1991 during thunderstorm from roof window, the Netherlands)



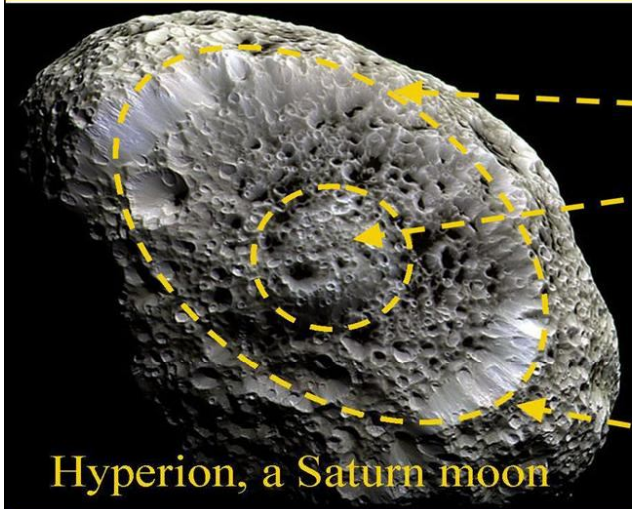
According to Quantum FFF Theory, even Nano interference Black Holes have a radial structured electric potential horizon layer (internal positive-protons and external negative electrons charged). They produce H<sub>2</sub> and water leading to the icy nuclei of Comets, Ball Lightning and Megacryometeors. The origin: a Fermion repulsion horizon of the black hole, see below.



7x Higgs quantum curves (2) are depicted for Fermions (3) with different distance to the BH. At location (10) the spin of the fermions will FLIP due to the propeller shape of the Fermion and an opposing force away from the horizon is created by the Higgs vacuum itself down to location (7). The zone between (7) and (10)

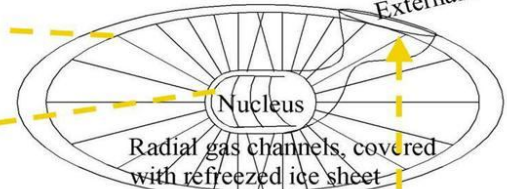
Figure: 20, Electric Black Hole based Ball Lightning

# Electric Dark Matter Black Hole Comets and Icy remnants (e.g. Hyperion)

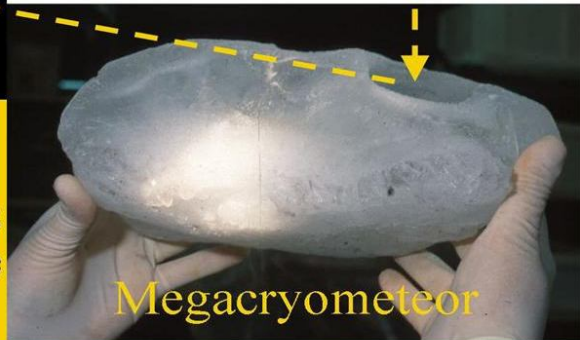


Hyperion, a Saturn moon

Cross section through a Megacryometeor or Terrestrial micro Comet nucleus.



Expected ice structure of the ellipsoidal ice chunk (Megacryometeor) found by J.M.Frais (Madrid). According to Quantum FFF theory this chunk should be the Nucleus of a Terrestrial Micro Comet, produced by a new paradigm black hole, which left the nucleus through the external hole, in consonance with the ice structure of the Hyperion moon. (author Leo Vuyk)



Megacryometeor

The relation between the Hyperion ice structure and the structure of a Megacryometeor as the result of Micro Black hole ice production inside both nuclei.

According to Quantum FFF Theory, even Nano interference Black Holes have a radial structured electric potential horizon layer (internal positive-protons and external negative electrons charged). They produce H<sub>2</sub> and water leading to the icy nuclei of Comets, Ball Lightning and Megacryometeors. The origin: a Fermion repulsion horizon of the black hole, see below.

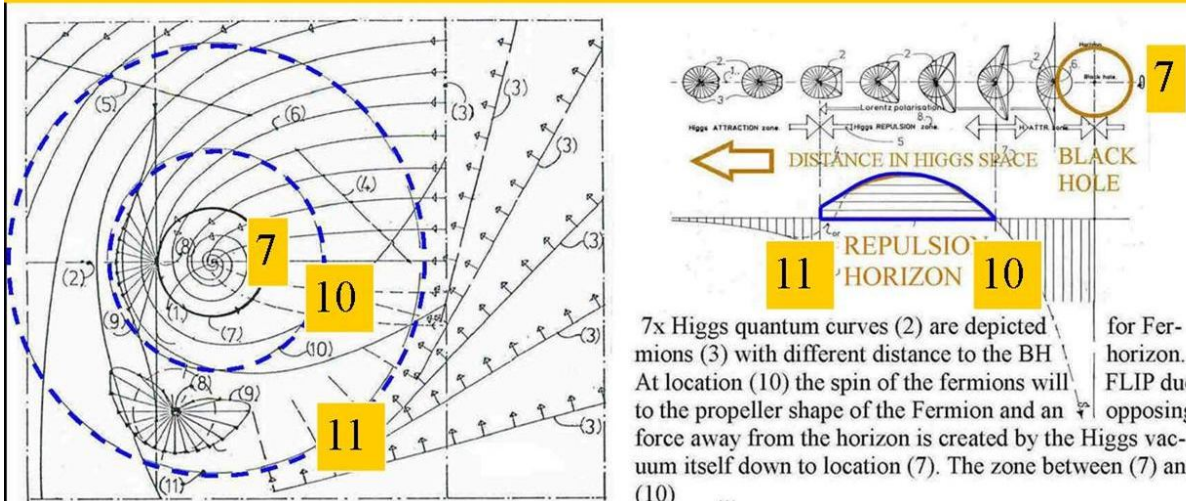


Figure: 21, Electric Black Hole based Comets and Micro comets.

## References:

- [1] [viXra:1103.0068](#) submitted on 16 Mar 2011  
**Function Follows Form, at the Quantum Scale and Beyond.**  
Authors: Leo Vuyk.
- [2] [viXra:1103.0024](#) submitted on 9 Mar 2011  
**Quantum Gravity and Electro Magnetic Forces in FFF-Theory.**  
Authors: Leo Vuyk.  
Category: [Quantum Gravity and String Theory](#)
- [3] [viXra:1103.0015](#) submitted on 5 Mar 2011  
**Wavefunction Collapse and Human Choice-Making Inside an Entangled Mirror Symmetrical Multiverse.**  
Authors: Leo Vuyk.  
Category: [High Energy Particle Physics](#)
- [4] [viXra:1103.0011](#) submitted on 3 Mar 2011  
**An Alternative Black Hole, Provided with Entropy Decrease and Plasma Creation.**  
Authors: Leo Vuyk  
Category: [High Energy Particle Physics](#)
- [5] [viXra:1103.0002](#) submitted on 1 Mar 2011  
**3-Dimensional String Based Alternative Particle Model.**  
Authors: Leo Vuyk.  
Category: [High Energy Particle Physics](#)
- [6] [viXra:1102.0052](#) 27 Feb 2011  
**Construction Principles for Chiral "atoms of Spacetime Geometry".**  
Authors: Leo Vuyk  
Category: [Quantum Physics](#)
- [7] [viXra:1102.0054](#) 27 Feb 2011  
**Atomic Nuclear Geometry Based on Magic Number Logic.**  
Authors: Leo Vuyk.  
Category: [Nuclear and Atomic Physics](#)
- [8] [viXra:1102.0056](#) 28 Feb 2011  
**Experiments to Determine the Mass Related Lightspeed Extinction Volume Around the Earth and Around Spinning Objects in the Lab.**  
Authors: Leo Vuyk.  
Category: Relativity and Cosmology
- [9] **The New God Particle and Free Will.**  
Author: Leo Vuyk, LuLu publishers, 2008. ISBN number: 978-1-4092-1031-3
- [10] [viXra:1104.0002](#) 1 Apr 2011,  
**Stellar Anchor Black Holes as the Remnants of Former Herbig Haro Objects.**  
Author: Leo Vuyk  
Category: Astrophysics
- [11] U.S. Inan, S.C. Reising, G.J. Fishman, and J.M. Horack. **On the association of terrestrial gamma-ray bursts with lightning and implications for sprites.** *Geophysical Research Letters*, 23(9):1017-20, May 1996. As quoted by <http://elf.gi.alaska.edu/spr20010406.html#InanUS:theatg> Retrieved 2007-03-06.
- [12] **Scientists close in on source of X-rays in lightning.**  
*Physorg.com*, July 15, 2008. Retrieved July 2008.  
<http://www.physorg.com/news135351802.html>
- [13] **"Bright points in sun's atmosphere mark patterns deep in its interior"**  
<http://www.sciencedaily.com/releases/2014/04/140417191744.htm>  
also: "Identifying Potential Markers of the Sun's Giant Convective Scale". Scott W. McIntosh, et al.  
<http://arxiv.org/abs/1403.0692>