

Construction principles for chiral “atoms of spacetime geometry” including space curvature around massive objects.

Leo Vuyk,
Architect,
Rotterdam, the Netherlands.

Abstract,

Construction principles for chiral “atoms of spacetime” based on geometrical 3-D chiral lattice models and some consequences for spacetime, general relativity based space curvature and Time variation, including cyclic Universal time, and local time.

Introduction.

Many physicists have searched for the ontological base for time and the construction principles of space time fabric.

I present here a recent example with their original descriptions.

J. Ambjørn wrote [ref. 1,2]:

“To show that the physical spacetime surrounding us can be derived from some fundamental, quantum-dynamical principle is one of the holy grails of theoretical physics.

The fact that this goal has been eluding us for the better part of the last half century could be taken as an indication that we have not as yet gone far enough in postulating new, exotic ingredients and inventing radically new construction principles governing physics at the relevant, ultra-high Planckian energy scale.”

Being an architect, I am specially focussed on the geometrical part of these questions.

I found out that spacetime geometry and the geometry of elementary particles could be linked if we consider wave particle duality as a mechanical conversion process inside a 3D energetic oscillating “Massless but energetic oscillating Higgs vacuum lattice” and elementary particles with real convertible shapes. (Fig, 3,5,10)

I called it “Quantum Follows Form Theory” (Q-FFF) because the functions of each particle is based on its interaction possibilities with the oscillating Higgs vacuum lattice..[ref. 3-32]

Here I humbly present a possible structure of the spacetime fabric, elementary particles, and some consequences for our understanding of TIME.

In Quantum FFF theory, the interaction between oscillating Higgs vacuum particles and Fermions is responsible for a local reference frame with its own local TIME.

TIME is the ticking of a local clock based on the jitter of the local (Cesium) atoms by the collisionary interaction with its Fermions and the massless oscillating Higgs vacuum particles.

If the oscillating Higgs vacuum lattice is deluded around large masses and BHs then time is retarding and light also. (fig. 3)

The Universe is cyclic by the “constant eating” of the vacuum by all Black Holes leading to a shrinking multiverse and a Big Crunch-- Big Bang based Cyclic system with universal TIME. (fig.1)

The CPT SYMMETRIC MULTIVERSE CYCLE.

The Inflation epoch starts if the decreasing vacuum pressure equals the increasing Higgs tension of the Big Crunch black hole nucleus. Inflation epoch ends if all splintered black hole nuclei are evaporated, or left behind as Galaxy Anchor Black Holes.

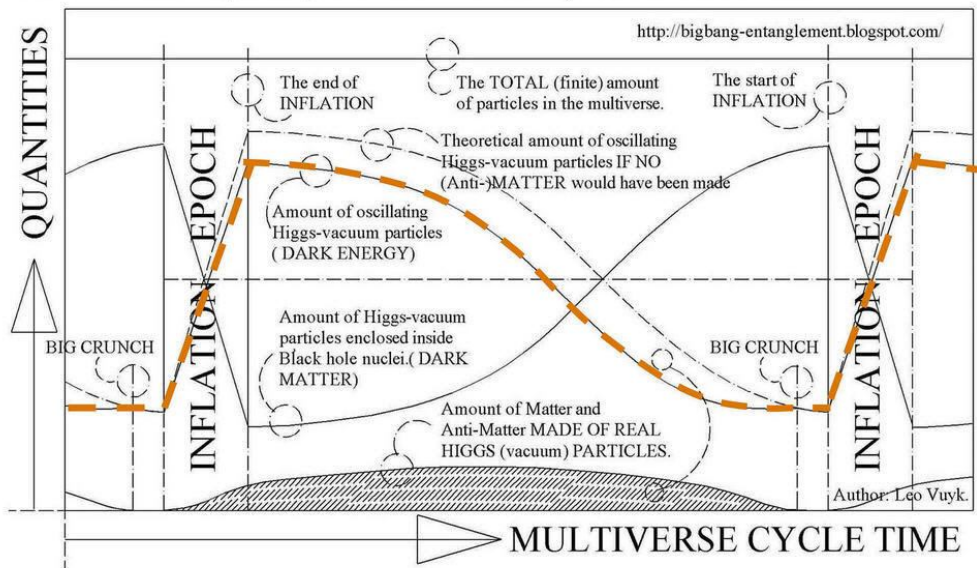

The Pulsating Multiverse depicted as a continuous flow of increasing and decreasing numbers free oscillating- and Black hole condensed Higgs particles and the amount of Quarks and leptons. The size of the pulsating multiverse vacuum is given in orange.

Figure 1, Cyclic universal time, The orange line represents the volume of the total Higgs vacuum lattice.

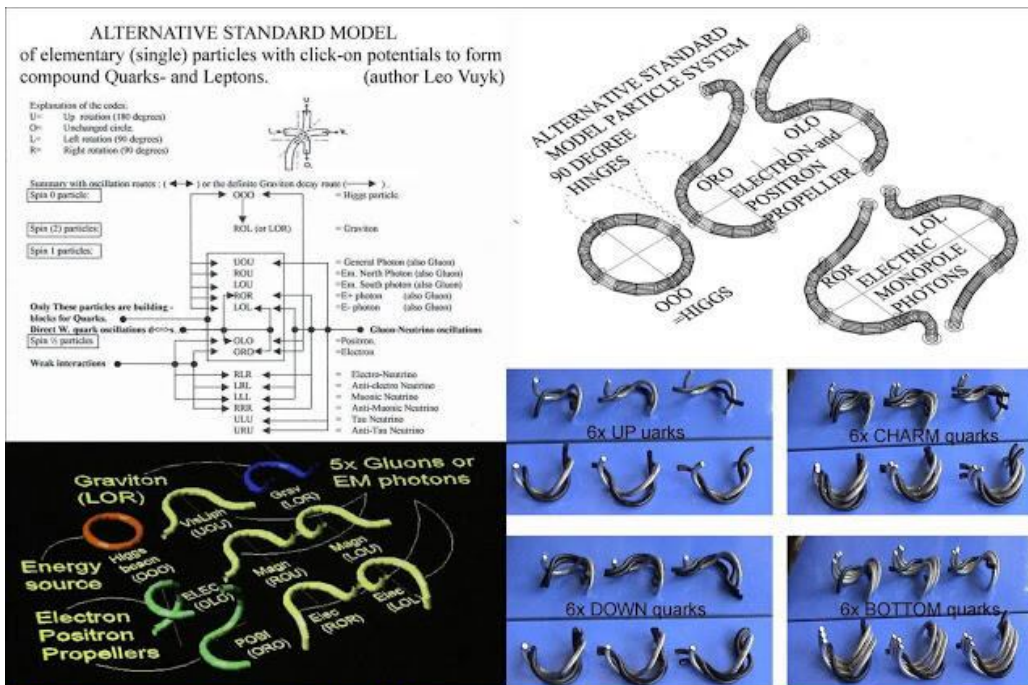

90 degree rotation of the Higgs ring and merging into coumpound knots...

Figure 2, The principle of convertible elementary particles merging into Quarks and some leptons. An alternative standard model with Dark Energy massless Higgs and Dark matter Black Holes.

New Dark Matter Black Hole, “Eat” the chiral oscillating Higgs vacuum.(Quantum-FFF Theory)

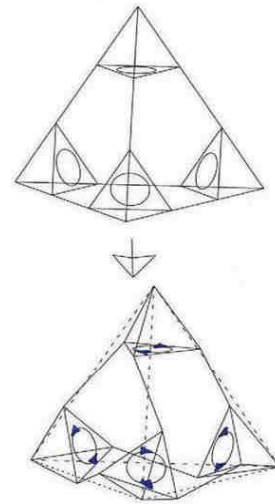
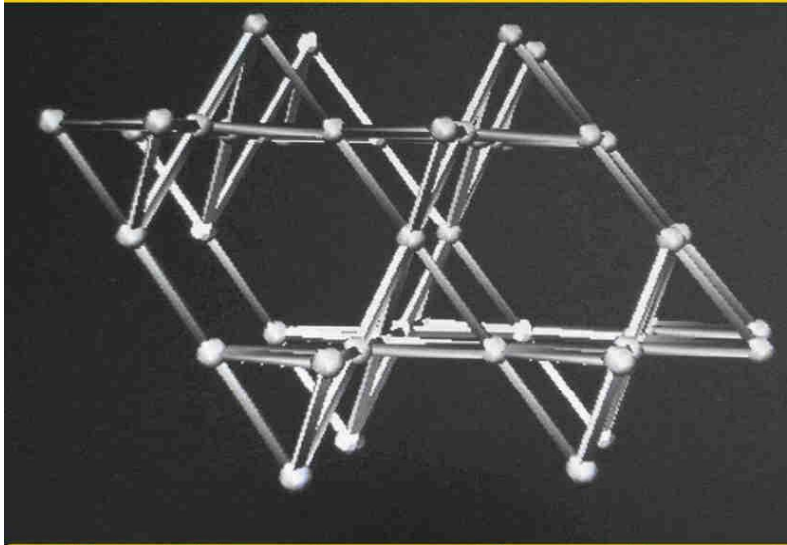

Simplified tetrahedral vacuum lattice structure (left), constructed by complex chiral tetrahedral building blocks (right). Each universe has to choose between a left- or righthanded rotation of its tetrahedral building blocks. Each chiral lattice has the Planck length and is supposed to be equipped with at least two oscillating massless new Higgs particles.

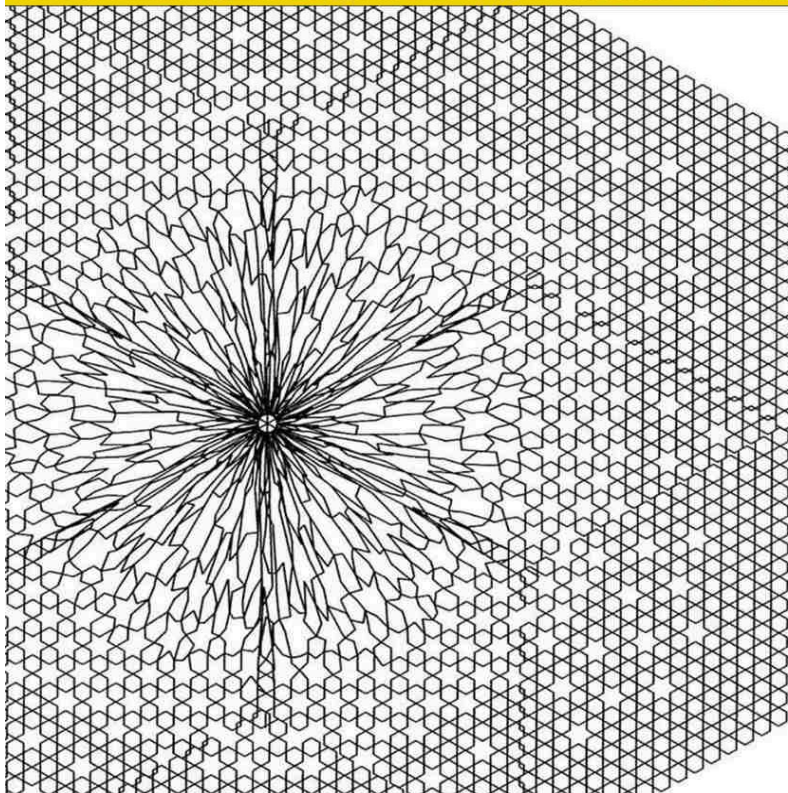

Black holes EAT the vacuum lattice with the oscillating Higgs particles. So, the vacuum lattice structure around a black hole could be represented like this.

As a result, the near vacuum is thinner or diluted, it has holes, which could be the origin of the Universal HUBBLE redshift.

By contrast, my new black hole paradigm says: the origin of universal redshift is Dark matter.

Dark matter is the proliferation of vast numbers of Black holes around Galaxies. Conclusion, based on Hubble redshift, we don't know anything about expansion or contraction of the universe.

(Author Leo Vuyk)

Figure 3, The fine structure of the dual oscillating Higgs vacuum and the influence on the vacuum structure of a dark Matter black hole “eating” the vacuum. The result is that the Higgs particle volume of the vacuum will decrease leading to the Big Crunch, and local time of Cesium oscillations in your watch is retarding in accordance with General relativity.

This system of space curvature is also supposed to be present around massive objects like stars and planets, also leading to light beam curvature and redshift. See quantum gravity:

Fermion repulsion zone 10-11 around a Black hole, with Photon and Higgs trajectories around a NEW paradigm Black Holes.(Quantum-FFF Theory)

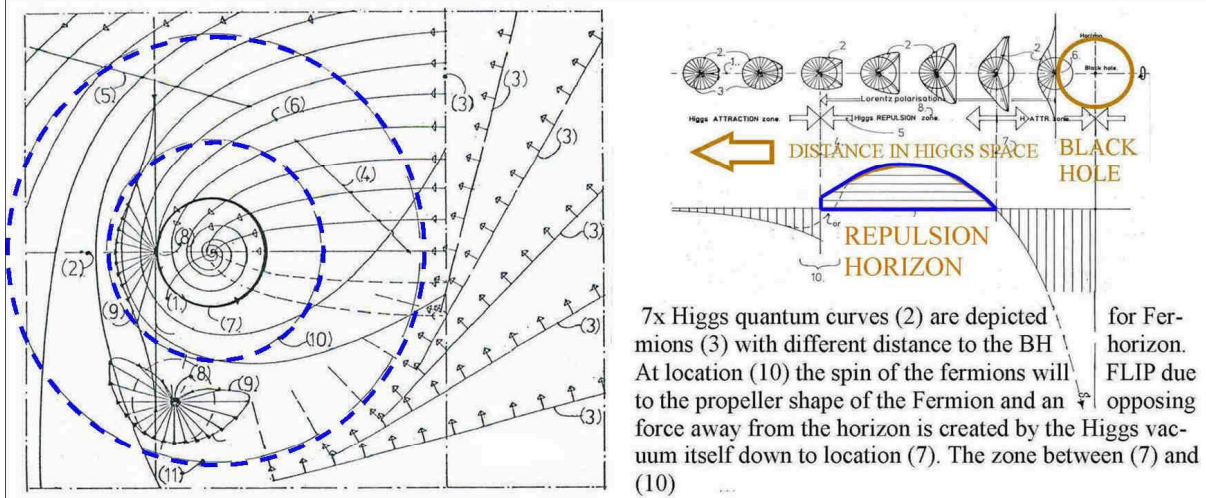

- 1: Non rotating Black hole nucleus (in 2D cross section).
- 2: Reference axis for trajectories 4,5 and 6.
- 3: Other incoming photonic/Higgs fronts (without depicted trajectories)
- 7: High photon energy collider globular shell, with intense Quantum effects like pair production (e^-e^+). 8: test masses.
- 9: Butterfly shaped Higgs/photon Fermion pushing curves in 2D.
- 10 and 11: Fermion repulsion zone. Due to the propeller shape of the Fermions, they will experience a so called "Spin Flip" in this zone.

Figure 4, There are three horizons around a black hole. 1: a so called Firewall (7) creating pair production, 2 and 3: depicted in blue color; the boundaries of the FERMION REPULSION ZONE.

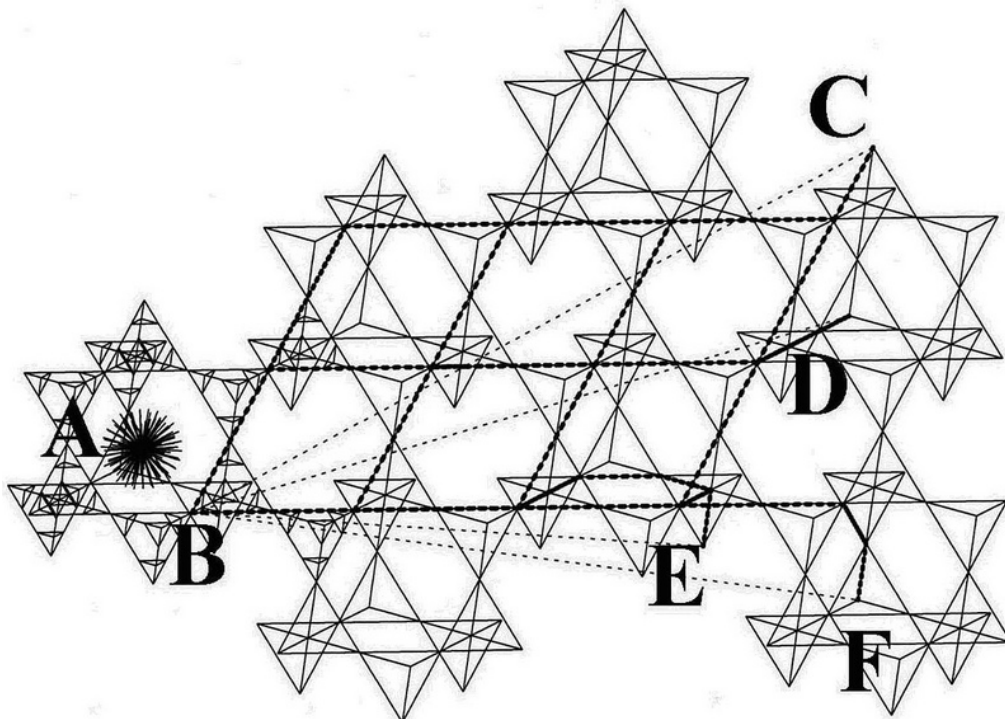

Figure 5, Photon trajectories through the truncated tetrahedral Chiral vacuum lattice. a Fermion is spinning at **location A**, the spinning is the result of Higgs collisions.. Fermion A. radiates 5 types of Gluons and one type of Graviton (**ref 28**) by the constant collision transformation process with the dual oscillating massless Higgs particles. (**figure 2**) Higgs particles are changing form into 5 Gluons / Gravitons by this process.

Most Gluons are supposed to hit and merge with other surrounding Fermions like electrons and other Quarks. However some Gluons will escape and then I call them Photons, which will transfer its Photonic shape and polarisation information to the Higgs vacuum system (**location B**), which seems to be able to transfer this information through the vacuum lattice and transfer the original photon back as a pop-up particle at **locations C,D,E and F after interference with a second fermion.**

The photon information is supposed to be spread over multiple vacuum lattices to present a wavelike form and “collapse” into one real shaped photon by transformation of ONE local Higgs particle. (to be in line with the one photon double split effect)

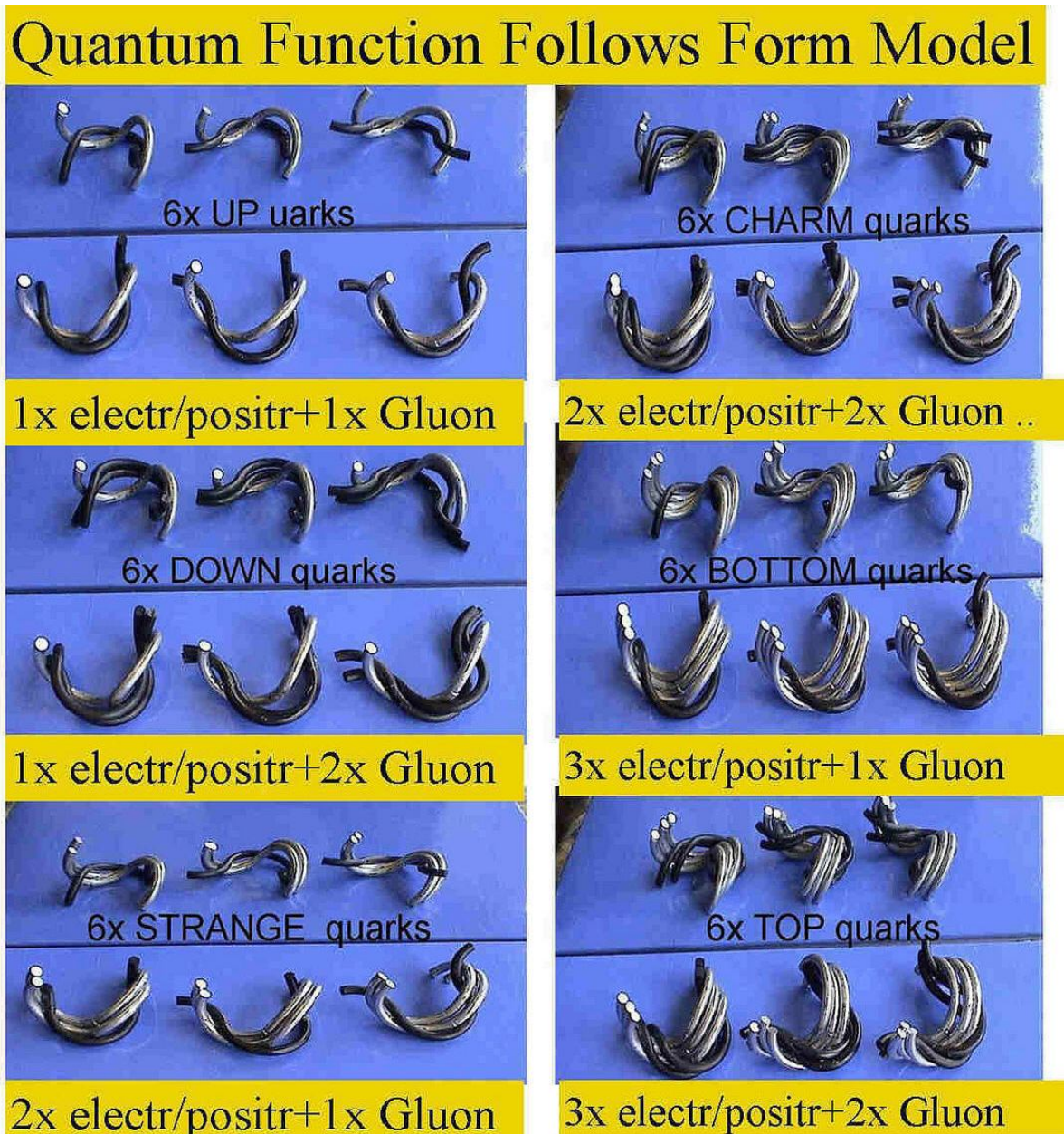
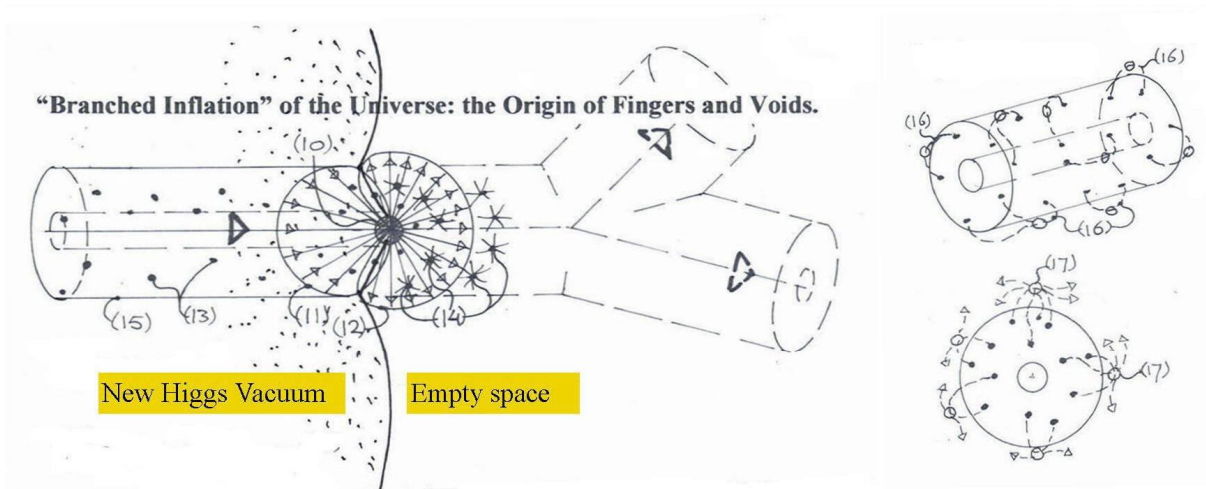

Figure 6, Alternative Standard Model for Quarks as composite particles of positrons, electrons and 5x gluons, able to create the different colors of Quantum Chromo Dynamics.



The origin of the Lyman Alpha Forest (15) and Higgs vacuum, by the splitting of the Big Bang Black Hole (BBBH) into smaller Splinter BHs (10). The splinter BHs (10) evaporate into smaller evaporating black holes at the Front (14) which compensate the pressure from the Backside splinter BHs (11). The BHs (11) are assumed to partly evaporate like BHs (14) also into a newly formed oscillating Higgs vacuum until the Higgs vacuum pressure stops the evaporation and leave Galaxy Forming BHs (13) behind. However single BH will pair (16) with the nearest other BHs to form Dumbbell systems, which efficiently form Giant Stars and Galaxies (17) in between. (author: Leo vuyk)

Figure 7, How the Higgs vacuum lattice was formed by the Big Bang evaporation of the Big Crunch Black Hole, leaving behind a symmetrical Raspberry shaped Multiverse with particle entanglement over universal distances.

Dark Matter Black holes of all scales even microscopic sized inside silicon globules and outside Galaxies, according to Quantum FFF Theory

Figure 8, In the raspberry Multiverse, the dark matter black hole is of all scales, even microscopic in the lab. Microscopic BHs evaporate by the fierce attack of the Higgs oscillations. Larger BHs (sunspots and Comets) seem to be able to survive and grow by the eating of the Higgs vacuum.

Synchrotron radiation by Polarized Fermion spin combined with high speed motion through the resistive oscillating Higgs vacuum (according to Quantum FFF theory)

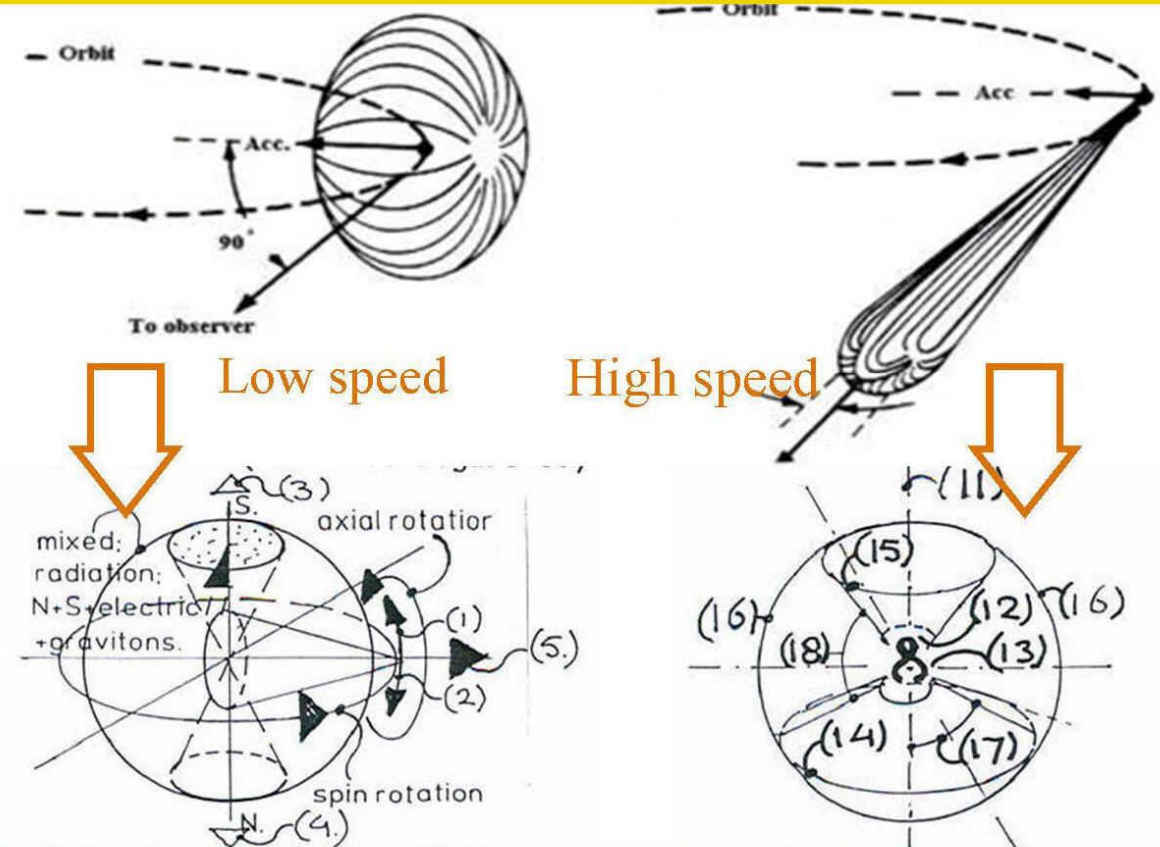

The propeller shape of Fermions is the origin of a dual spin state by collision influences of the oscillating massless Higgs vacuum at low speeds. (Spin rotation and axial rotation) At high relativistic speed the Lorentz polarization of the Fermion "propeller nose" (1 or 2) is preferentially pointing into direction (11) with synchrotron radiation cone focussing (15) into the opposing vacuum direction and the Spin rotation has gone.

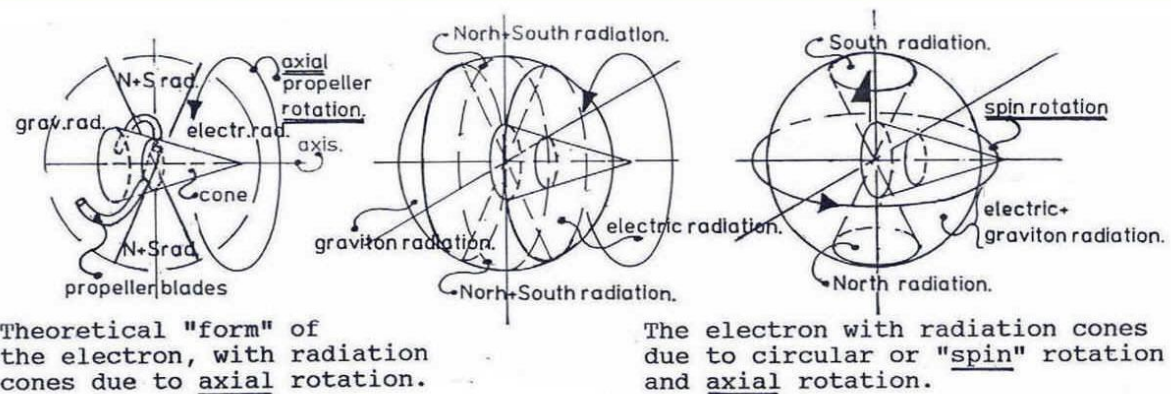
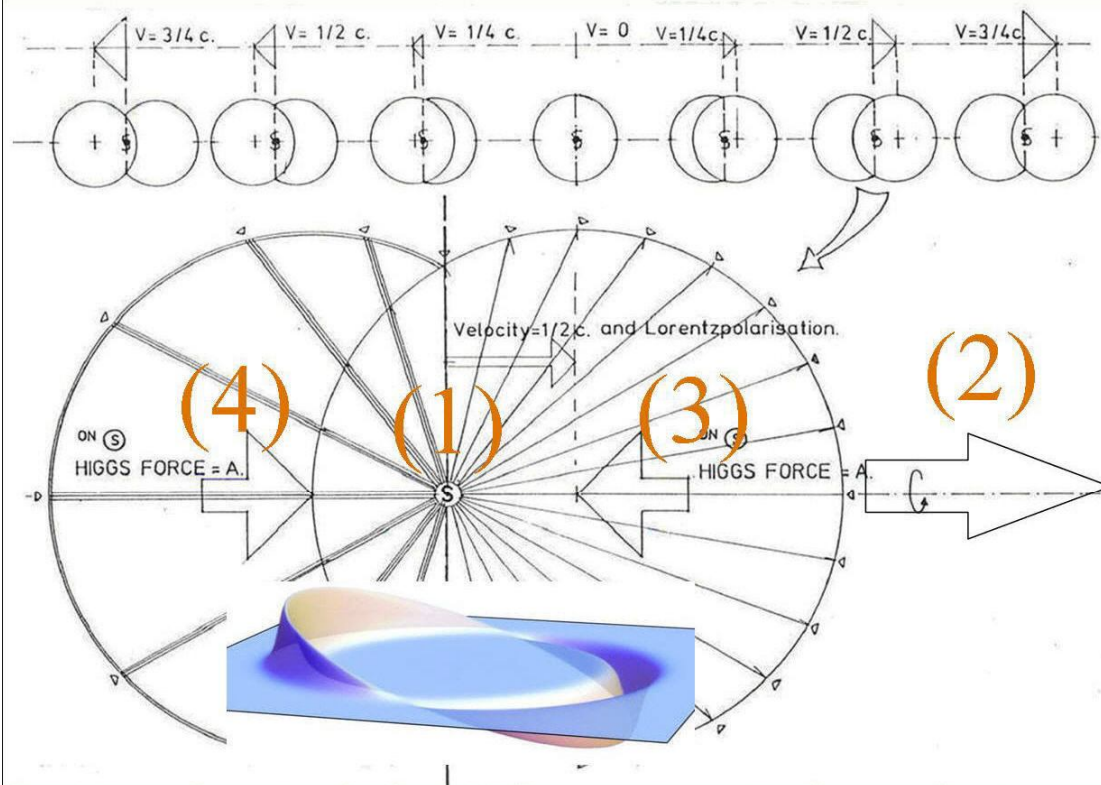

Figure 9, The Double spin of fermions, the radiation cones of different shaped monopole electro magnetic Photons and gravitons and the polarization effect on accelerated Fermions in a synchrotron device.

Polarized Fermion Mass in motion through the resistive, but also pushing oscillating Higgs vacuum (according to Quantum FFF theory)



Cross section through the 3D vector field pressure distribution on a Fermion point mass (1). Propeller shaped spinning Fermions are supposed to be Polarized into the direction of flight through the vacuum lattice (2). As a result, the resistive vacuum Higgs force (3) is compensated by the Higgs Pushing force (4) from the “backside” of the Fermion. However every Fermion need to have polarization memory consciousness. (by a multi universal entanglement system see: Quantum-FFF theory)

Figure 10, Warp Drive of the vacuum on Lorentz polarized fermions to overcome the vacuum resistance of the vacuum itself.

All motion related to the local vacuum reference frame creates time retardation. (in accord with Einstein)

In Quantum FFF theory, the interaction between oscillating Higgs vacuum particles and Fermions is responsible for a local reference frame with its own local TIME.

TIME is the ticking of a local clock based on the jitter of the local (Cesium) atoms by the collisionary interaction of its Fermions with the massless oscillating Higgs vacuum particles.

If the oscillating Higgs vacuum lattice is deluded around large masses and BHs then time is retarding and light also. (fig. 3)

All motion related to this reference frame creates time retardation. (in accord with Einstein)

However the Lightspeed is NOT constant all over the universe. Only perpendicular to massive objects it seems to be constant. Radar reflection experiments between Earth and Venus proved Einstein wrong. See: Experiments to Determine the Mass Related Lightspeed Extinction Volume (ref.31)

Comparison of the Final ESA CMB Planck map with a cross section through the Raspberry Multiverse according to Quantum Function Follows Form theory. Compare the Cold Spot with the Void and the Warmer and Colder Hemisphere of the Plack CMB (left) with observation boundaries (right)

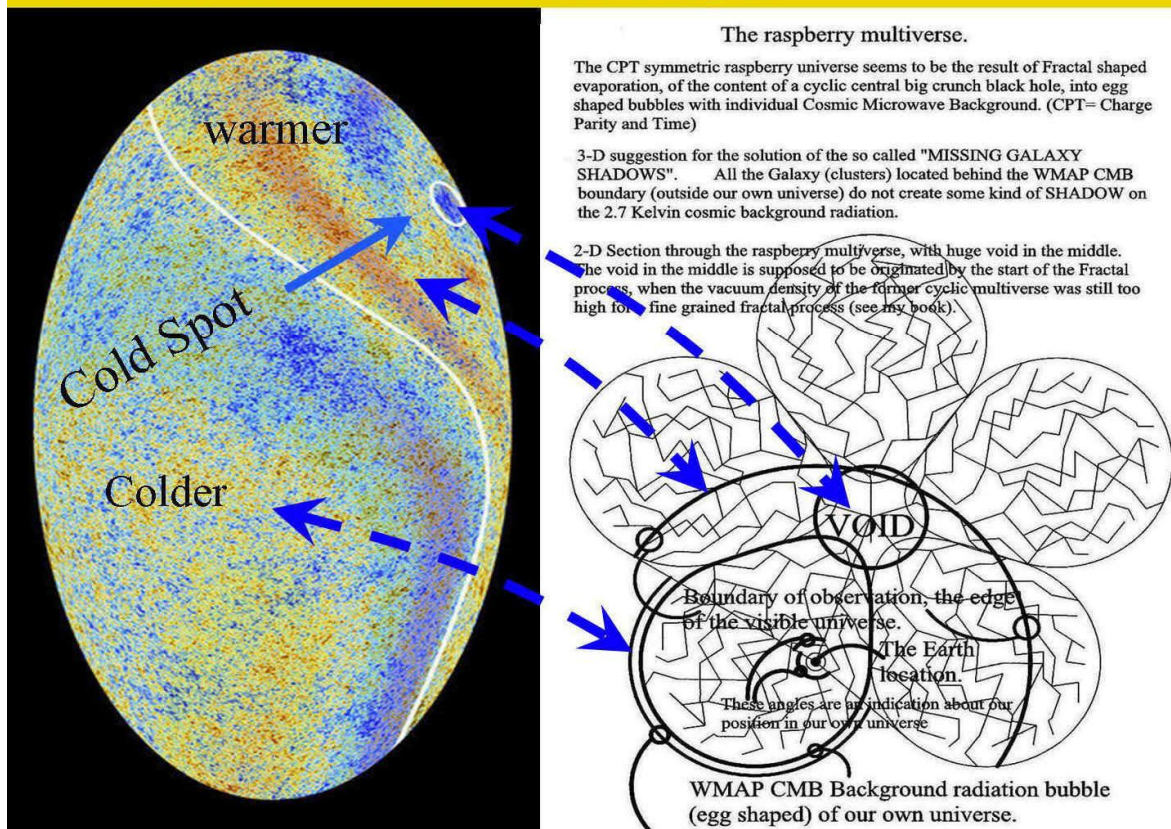

Figure 11, Recent support by the CMB Planck Map for the Raspberry shaped Cyclic Multiverse.

The fourth dimension seems to be the oscillation speed (potential time base) of the Higgs doublets along the Cosmic lattice edges of the vacuum spin field. Higgs particle doublets are supposed to oscillate in "tandem" or doublets (like a boxer piston engine) along each vacuum lattice edge, to be able to transfer photonic information properly. This system need to have Higgs particle doublets because otherwise it would be impossible to have a decent information transition system at the information properly. In this system, one lattice edge is supposed to equal one Planck length. The spiral structure of the vacuum lattices gives the vacuum a chiral influence on spinning and merging

Fermion particles and a photonic polarisation. The chirality of this system is supposed to be the origin of our material universe.

Around black holes, the Higgs lattice system will be absorbed by the black hole and as a consequence, the vacuum is thinned and the Planck length will vary and locally even increase!!!

As a consequence, the lightspeed of radiation passing the black hole, will decrease and suffer a redshift.

However, if we assume that black holes are the same thing and origin of Dark Matter, then the Hubble redshift is not a tell tale of the expansion of the universe.

TIME is assumed to run forward (right-handedness of clocks) because the universe is like a huge pinball machine. Spinning Fermions (the pinball) are driven by the oscillating Higgs field (the electric springs) which is supposed to be the origin of the general increase of entropy base of the second law of thermodynamics.

However dark matter in the form of black holes will eat the dark energy of the Higgs field and decrease entropy again, reason to postulate a pulsating and cyclic universe.

Universal Symmetry is not broken if we accept that each material universe is entangled at a long distance with an anti-material copy universe, equipped with opposite chirality inside the oscillating Higgs lattice field.

As a consequence Time never runs back in anti-material entangled universes, clocks have left-handed rotation over there.

This Evolving Star Planetary Nebula is presenting over a double pair of Solar Anchor Black Holes (located at A & B) and a star is located at C. The shape of this system is an example of double ring shaped dark matter/ super gravit influence.

This Exploding Star (Planetary Nebula M2-9) is presenting only two Solar Anchor Black Holes located at A and B. The star is located at C. The shape of this system is an example of double ring shaped dark matter/ super gravit influence.

Two accelerating, pairing and receding micro black holes in the Carina nebula with temporary meeting place A.

Two accelerating, pairing and receding micro black holes in the Carina nebula with temporary meeting place A. and ionised H2 gas trail.

Two gas pillars in the Carina Nebula with Herbig Harrowick (A) formed by pairing and splitting from black holes.

Cannonball galaxy Gas concentration by two different black hole systems: A and B.

BH System A - left over from the Big Bang inflation splitting epoch.

BH System B - created by the first extreme star supernova explosions (ejecting star-spots BHs).

Gas concentration by stationary dual Black Holes at all universal scales, inside (early) Cannonball Galaxies, Nebulae and Herbig Harrowick objects.

A good example of the Cygnus A Galaxy, with two BH nuclei.

Two electron jets from the black hole horizon, so produce jets of ionized gas, proceed together in the center.

Typical form example of pairing black holes leaving gas trails and a BH-BH system and star formation on different scales.

The origin of Elliptical Galaxies and complex external Dark Matter lobes, by merging of "early" spiral galaxies, each equipped with two Galaxy anchor black holes (GAHBs) located on each side of the equatorial plane of the spiral.

The raspberry multiverse.

Hyperion's globular inner nucleus is a firm indication of entry decreased at the boundary between Higgs repulsion and attraction zones (4) around NEW (micro) black holes.

WMAP CMB Background radiation bubble (egg shape) of our own universe.

The NEW Black Hole Paradigm.

The Nucleus of the NEW Black Hole.

The Multiverse Cycle Time.

7x Higgs quantum curves (2) are depicted for Fermion production.

What is wrong with Physics at the astronomical scale?

Ball lightning pushed by Plasma tail against the wind

Vapour trail washed out by the wind

Author: Leo Vuyk 4-02-2011 NL LeoVuyk@Gmail.com <http://bigbang-entanglement.blogspot.com/>

Figure: 12, what is wrong with physics at the astronomical scale.

THE SECRET OF BALL LIGHTNING. Its production by e.m.- x-ray interference into a KNOTTY Nucleus, able to accelerate, decrease Entropy and produce Vapour.



The NEW Black Hole Paradigm

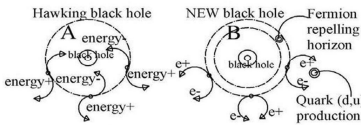

The standard Hawking Radiation postulate is: that all matter (NOT all energy) is drawn into the Black hole.
 My NEW postulate is that matter is even created (and pushed outside) at the Black hole horizon by QUANTUM FLUCTUATIONS producing Electrons and Positrons.
 The reason for this NEW Fermion production effect is, that it is a consequence of the concentration of head-on Higgs particle collisions just at the horizon. Some Electrons and Positrons will annihilate, but the rest will form Quarks and plasma, because the Higgs vacuum lattice is CHIRAL and prefer to link Gluons to Positrons and form U- Quarks in favour of Electrons and Gluons, which form D-Quarks.
 Thus more Electrons will stay single and form Hydrogen atom shells. However they have less mass than Quarks and feel less attraction to the Black hole nucleus, thus Electrons form also an external shell around the Black hole inner shell of Protons and some Neutrons!
 Due to the propeller shape of the particles all the plasma is repelled away from the black hole! The Black hole will not evaporate!
 This is the base for NEW Physics and a support for a new explanation of Cometary X-rays, Hydrogen and AMINO ACID production. Even Gas Pillar and Herbig Haro formations inside Nebula become a logic base. Author Leo Vuyk.



Ball lightning pushed by Plasma tail against the wind
 Vapour trail washed out by the wind

How is the vacuum able to release energy to overcome the opposing wind? By SPIN FLIP and the Plasma tail is always swept at the back of the BL by the wind itself!

The Fermion repelling horizon

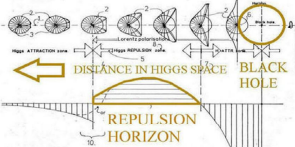

7x Higgs quantum curves (2) are depicted for Fermions (3) with different distance to the BH horizon. At location (10) the spin of the fermions will flip due to the propeller shape of the Fermion and an opposing force away from the horizon is created by the Higgs vacuum itself down to location (7). The zone between (7) and (10)

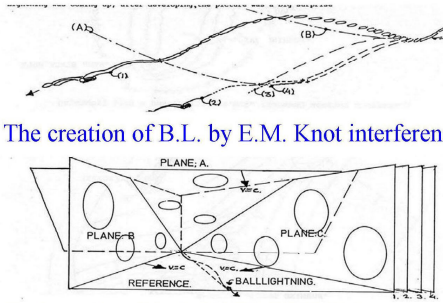

The creation of B.L. by E.M. Knot interference

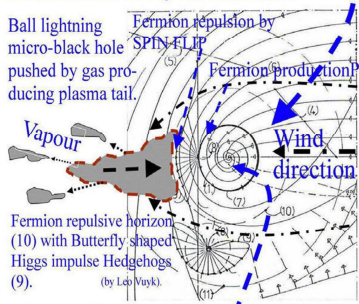

Ball lightning pushed by gas producing plasma tail.
 Fermion repulsion by SPIN FLIP
 Fermion production pushed by gas producing plasma tail.
 Wind direction
 Vapour
 Fermion repulsive horizon (10) with Butterfly shaped Higgs impulse Hedgehogs (9).
 (by Leo Vuyk).



Knotty Micro-Black hole nucleus

Author: Leo Vuyk 10-02-2011 NL. <http://bigbang-entanglement.blogspot.com/>

Figure: 13 The secret of electric dark matter black holes, like ball lightning, producing ionized plasma.

Examples of relativistic electron jets and H-alpha ion gas clouds and streamers in between Galaxy Anchor Black Holes (GABHs) of Cygnus-A and between multiple GABHs the center of Galaxy clusters, Perseus and Virgo, according to Quantum FFF theory.

Creation of Hydrogen ion clouds by two Fermion repelling Black holes

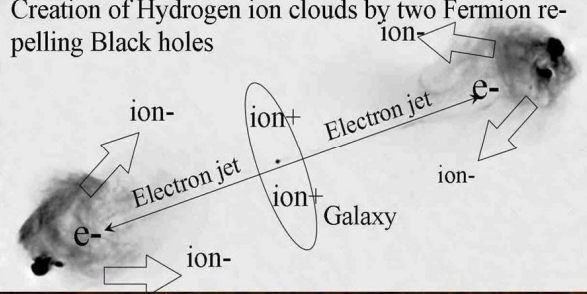

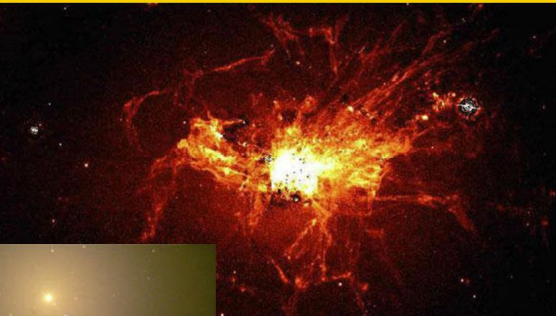

NGC 1275 H-alpha, in Perseus

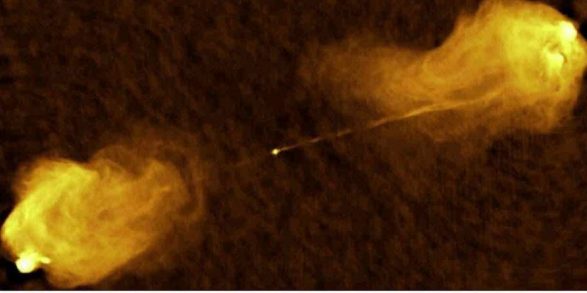

M86 jet in Virgo

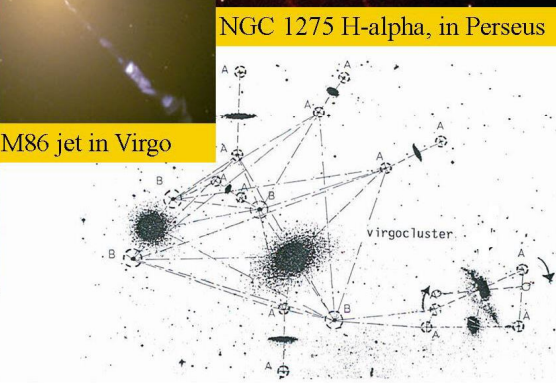

Virgo cluster

Cygnus A Hotspots (new paradigm black holes) showing ionized gas production, based on the new elementary particle paradigm. Quarks are compounds of electrons- or positrons with photons. (author Leo Vuyk)

Figure: 14, Other examples of electric dark matter black holes producing ionized plasma (Galaxy Anchor Black holes)

Alternative Feynman diagrams with additional ZPE vacuum Higgs impulses, combined with electric and magnetic monopole photon impulses, according to Quantum FFF Theory

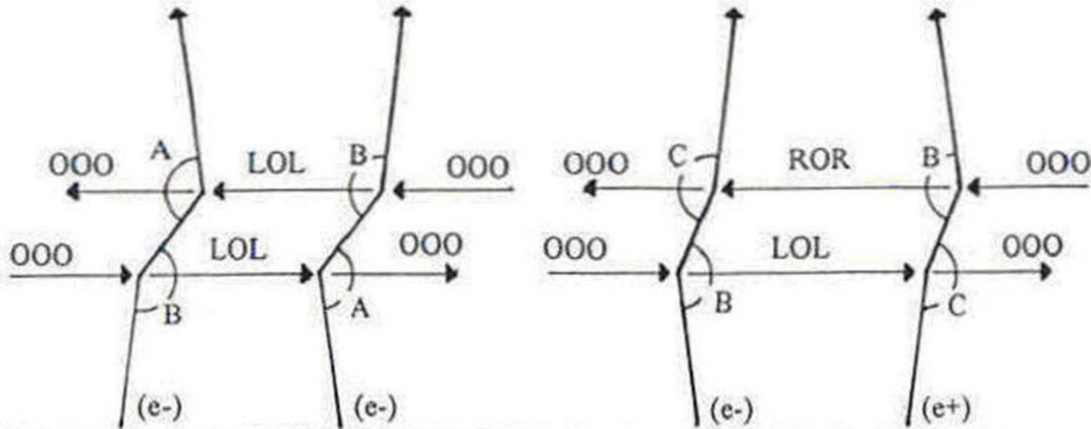

Higgs (OOO), Neg. Photon (LOL) Pos. Photon (ROR) all change form after collision with Fermions

Higgs impulse diagram for Double LeSage Gravity, according to Quantum FFF theory.

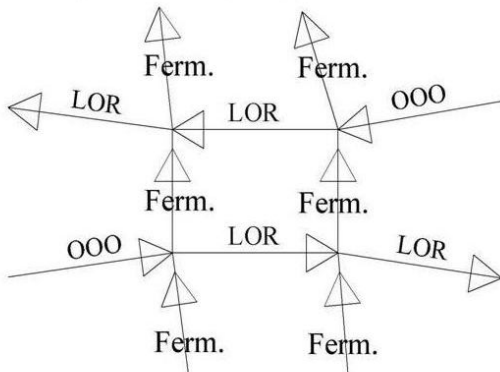

Fermionic impulse differences with Higgs (OOO) and pushing Gravitons (LOR). OOO changes form after collision into LOR. Gravitons don't change shape after collision.

Higgs Impulse diagram for MAGNETIC monopole radiation, according to Quantum FFF theory.

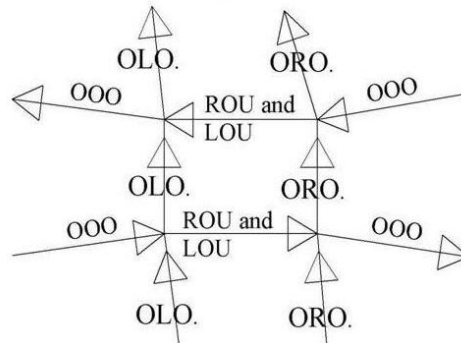

Fermionic impulse differences between Higgs (OOO) and TWO Magnetic monopole photons (LOU and ROU) on Fermions (OLO and ORO). OOO changes form after collision with OLO resp ORO into ROU and LOU and after second collision back again into OOO.

Quantum Gravity (left) and Magnetic forces (right). Vacuum Higgs Chirality and particle geometry and spin plays an important role

Figure: 15, Alternative Feynman diagrams. How double push gravity and all other double push forces of nature work.

Quantum Gravity as pressure distribution of the oscillating dual Higgs/Graviton vector field.

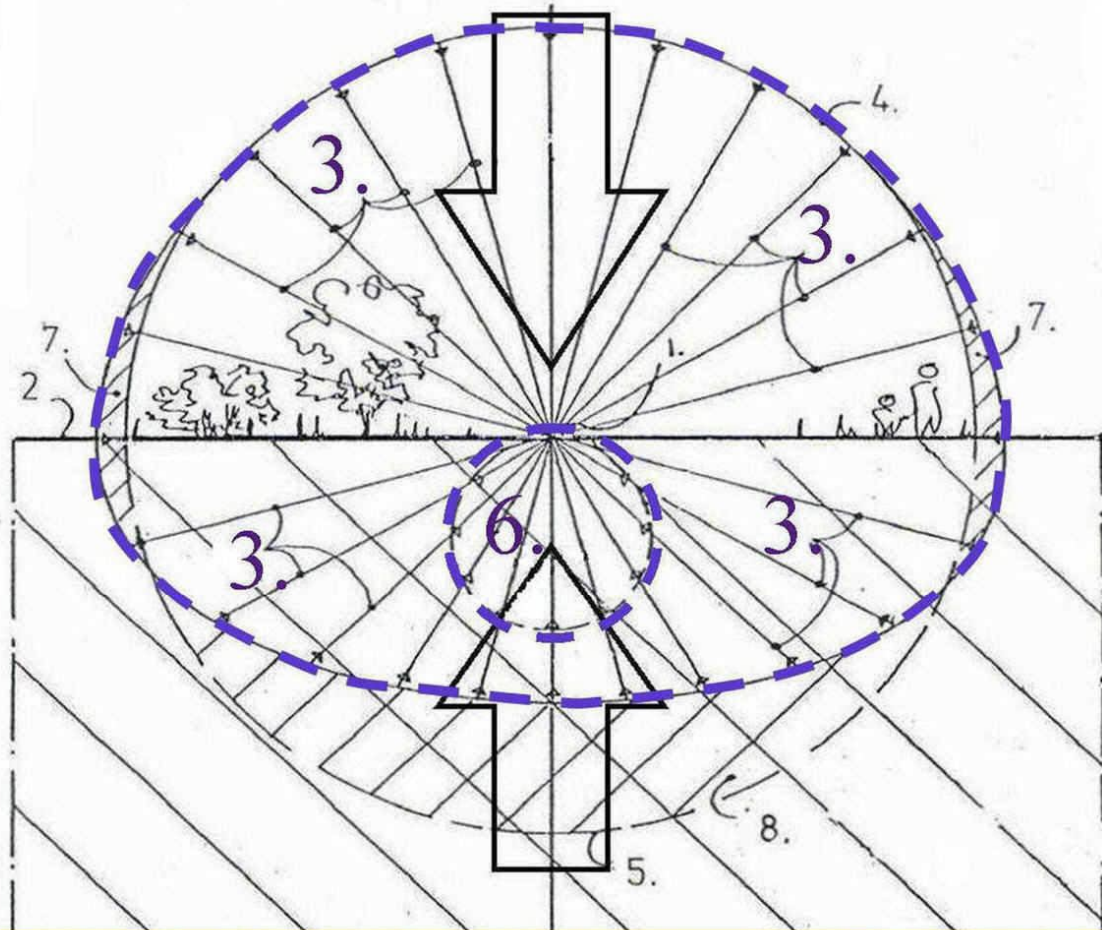

Cross section through the dual Higgs/ Graviton 3D vector field pressure distribution (or globular Hedgehog) on a point mass (1) located on earth's surface (2), according to Quantum FFF theory. $3+4=$ Higgs vector field. $6=$ Graviton vector field originated by the Higgs-graviton field transformation of the earth itself. $7+8=$ differences with a perfect globular vector distribution. Field variables $3+6$ are rendered as inversed arrows. (see also black hole pressure distribution without gravitons)

Figure: 16, Dual Higgs/ Graviton quantum gravity.

References,

- [1] Planckian Birth of the Quantum de Sitter Universe
J. Ambjørn , A. Görlich J. Jurkiewicz , and R. Loll
http://arxiv.org/PS_cache/arxiv/pdf/0712/0712.2485v2.pdf
- [2] J. Ambjørn, J. Jurkiewicz and R. Loll: *Emergence of a 4D World from Causal Quantum Gravity*, Physical Review Letters 93 (2004) 131301 [arXiv: hep-th/0404156].
Author leo Vuyk:
- [3] viXra:1305.0041 The Shnoll Effect Explained by Quantum FFF Theory.
- [4] viXra:1304.0022 The Self Organizing Universe in the Carina Nebula.
- [5] viXra:1303.0211 Hubble Redshift Combined with Universal Contraction is Possible.
- [6] viXra:1303.0053 Micro Birkeland Currents Between Two RF Generated Plasma Balls in the Laboratory.
- [7] viXra:1302.0172 Silicon Based Ball Lightning Globule Structures and Signs for Accumulation and Retarded Decrease of Tunneling Energy Bullets.
- [8] viXra:1301.0088 Two or Three Large Quasar Groups (LQGs) Located at the Start of Two or Three Lyman Alpha Systems and a Part of the Raspberry Multiverse?
- [9] viXra:1301.0050 Dwarf Galaxies and Their Relation with Dark Matter Based Galaxy Anchor Black Holes (Gabhs).
- [10] viXra:1210.0177 Instant Broglie Bohm Pilot Waves, the Origin of All Entanglement Effects in the Lab and Wavefunction Collapses in Our Universe as Related to Our Opposing Anti-Copy Universe(s) According to Quantum FFF Theory.
- [11] viXra:1209.0092 New Dark Matter Black Holes and a New Dark Energy Higgs Field, Lead to a Bouncing CP Symmetrical Multiverse, and New Experiments.
- [12] viXra:1209.0061 Birkeland Currents, Sunspots, Comets and Ball Lightning Originated by New Paradigm Dark Matter Black Holes.
- [13] viXra:1209.0030 Majorana and Sterile Neutrino Solutions in the Quantum-FFF Model.
- [14] viXra:1208.0031 Clumpy Dark Matter Around Dwarf Galaxies a Support for an Alternative Black Hole Theory According to the Quantum Function Follows Form Model.
- [15] viXra:1202.0091 Earth Magnetic Monopole Array Field Interaction with Cyclotron – Synchrotron Electrons and Muon Conversion Used for Levitation Systems.
- [16] viXra:1201.0092 Earth Magnetic Monopole Array Field Interaction with Cyclotron Electrons used for Levitation Systems.
- [17] viXra:1112.0065 LHC Signals Between 121-130 GeV Interpreted with Quantum-FFF Theory
- [18] viXra:1111.0096 Reconciliation of QM and GR and the Need for a Pulsating Entangled CPT Symmetric Raspberry Shaped Multiverse.
- [19] viXra:1111.0061 Black Hole Horizon Curvature Dependent Balance Between Plasma Creation and e-e+ Annihilation in Quantum FFF Theory.
- [20] viXra:1108.0036 Artificial Ball Lightning Production and Exploitation Device for Zero Point Electric Energy Usage.
- [21] viXra:1108.0006 Mass in Motion in Quantum FFF Theory
- [22] viXra:1104.0083 Quantum FFF Theory in Posters.

- [23] viXra:1104.0044 Ball Lightning, Micro Comets, Sprite-Fireballs and X-Ray/gamma Flashes According to Quantum FFF Theory.
- [24] viXra:1104.0002 Stellar Anchor Black Holes as the Remnants of Former Herbig Haro Objects
- [25] viXra:1103.0097 ZPE Zero Point Energy Examples Around Black Holes.
- [26] viXra:1103.0068 Function Follows Form, at the Quantum Scale and Beyond.
- [27] viXra:1103.0024 Quantum Gravity and Electro Magnetic Forces in FFF Theory
- [28] viXra:1103.0015 Wavefunction Collapse and Human Choice-Making Inside an Entangled Mirror Symmetrical Multiverse.
- [29] viXra:1103.0011 An Alternative Black Hole, Provided with Entropy Decrease and Plasma Creation
- [30] viXra:1103.0002
3 Dimensional String Based Alternative Particles Model
- [31] viXra:1102.0056 Experiments to Determine the Mass Related Lightspeed Extinction Volume
- [32] viXra:1102.0054 Atomic Nuclear Geometry Based on Magic Number Logic.

=====