

# **Methods in Environmental Biotechnology for Environmentalists**

**W. B. Vasantha Kandasamy  
Florentin Smarandache  
S. R. Kannan  
S. Ramathilagam**

# **METHODS IN ENVIRONMENTAL BIOTECHNOLOGY FOR ENVIRONMENTALISTS**

**W. B. Vasantha Kandasamy  
Florentin Smarandache  
S. R. Kannan  
S. Ramathilagam**

**INFOLEARNQUEST  
Ann Arbor  
2010**

This book can be ordered in a paper bound reprint from:

Books on Demand  
ProQuest Information & Learning  
(University of Microfilm International)  
300 N. Zeeb Road  
P.O. Box 1346, Ann Arbor  
MI 48106-1346, USA  
Tel.: 1-800-521-0600 (Customer Service)  
<http://wwwlib.umi.com/bod/>

Peer reviewers:

Prof. Ion Goian, Department of Algebra, Number Theory and Logic, State University of Kishinev, R. Moldova.

Prof. Zhang Wenpeng, Department of Mathematics, Northwest University, Xi'an, Shaanxi, P.R.China.

Prof. Mircea Eugen Selariu,  
Polytech University of Timisoara, Romania.

Prof.N.R.Neelakatan, Retired Professor, Department of Chemical Engineering, Indian Institute of Technology, (Madras), Chennai, India

Copyright 2010 by InfoLearnQuest and authors  
Cover Design and Layout by Kama Kandasamy

Many books can be downloaded from the following  
Digital Library of Science:

<http://www.gallup.unm.edu/~smarandache/eBooks-otherformats.htm>

**ISBN-10: 1-59973-094-4**

**ISBN-13: 978-1-59973-094-3**

**EAN: 9781599730943**

**Standard Address Number: 297-5092**

**Printed in the United States of America**

# CONTENTS

Preface	5
Chapter One <b>INTRODUCTION</b>	7
Chapter Two <b>USE OF FAM MODELS TO ANALYSE THE POLLUTION CAUSED BY THE GARMENT INDUSTRIES</b>	11
Chapter Three <b>HIERARCHICAL GENETIC ALGORITHM TO IMPROVE THE SYSTEM PERFORMANCE AND REDUCE POLLUTION BY CHEMICAL PLANTS</b>	51
3.1 Introduction	51
3.2 Description of the Problem	53
3.3 Application of Hierarchical Genetic Fuzzy Control Algorithm to Control Process Variables of Decision Tables in Chemical Plants	56
3.4 Use of Hierarchical Genetic Fuzzy Control Algorithm in the Real Data	58
3.5 Conclusions	73

Chapter Four	
<b>IDENTIFICATION OF THE MAXIMUM AGE GROUP IN WHICH THE AGRICULTURAL LABOURERS SUFFER HEALTH HAZARDS DUE TO CHEMICAL POLLUTION USING RTD MATRIX</b>	<b>75</b>
4.1 Introduction	75
4.2 Estimation of the Maximum Age Group of the Agricultural Labourers having Cardio Vascular Problem due to Chemical Pollution using RTD Matrices	77
4.3 Conclusion	93
Chapter Five	
<b>MINIMIZATION OF SO<sub>x</sub> AND NO<sub>x</sub> USING FUZZY CONTROL THEORY IN CEMENT INDUSTRIES TO REDUCE POLLUTION</b>	<b>95</b>
5.1 Introduction	95
5.2 Description of the Problem	97
5.3 Process Fates of Sulfur in Cement Kiln	98
5.4 Process Fates of Nitrogen in Cement Kiln	99
5.5 Process under Fuzzy Control System	100
5.6 Adaptation of Fuzzy Control Method to find the Speed of Kiln for Minimizing the Waste Gas of SO <sub>x</sub> and NO <sub>x</sub>	102
5.7 Conclusions	130
<b>FURTHER READING</b>	<b>133</b>
<b>INDEX</b>	<b>141</b>
<b>ABOUT THE AUTHORS</b>	<b>142</b>

## PREFACE

The study of environmental pollution by chemicals used in agriculture as pesticide or as fertilizers or pollution caused by industries and chemical plants which use chemicals have not been analysed systematically.

This book has five chapters. First chapter is introductory in nature. Here we just study chemical pollution caused by garment industries in chapter two of this book using fuzzy associative memories.

In chapter three we give ways to control pollution by improving the system performance using hierarchical genetic fuzzy control algorithm. This study is carried out using the past data reported by Shimada et al (1995). Health hazards suffered by the agriculture labourers; caused by the chemicals used as fertilizers and pesticides is analysed in chapter four using RTD matrices. Chapter five gives a method of minimization of  $\text{SO}_x$  and  $\text{NO}_x$  using fuzzy control theory in cement industries to reduce pollution.

The reader is expected to have a good mathematical background to understand how these fuzzy techniques are adopted in analyzing the pollution problem.

The authors deeply acknowledge Dr. Kandasamy for the proof reading and Meena and Kama for the formatting and designing of the book.

W.B.VASANTHA KANDASAMY  
FLORENTIN SMARANDACHE  
S. R. KANNAN  
S. RAMATHILAGAM

## Chapter One

# INTRODUCTION

Environmental biotechnology is allowing major improvements in water and land management and also remediation the pollution generated by over industrial organizations. As rightly said by John E. Smith this newly acquired biological knowledge has already made vastly important contributions to the health and welfare of humankind. We view biotechnology will improve the infrastructure of the chemical industries to reduce and control pollution in chemical industries especially in India.

A through study of pollution caused by these chemical industries in India is in leaps and bounds. Some of the major polluting chemical industries are fertilizer plants, tanneries, oil refineries, cement industries and dying industries. They have not only proved hazarderous to human safety and health but also to the environment, like water resources, atmosphere, plants and land resources their by polluting the environment beyond repair. Farmers struggle with very poor yield due to pollution which has lead in the last few years mass suicide of the farmers. The pollution is two fold the very chemical fertilizers made the land after a stage infertile and the chemical pollution of the atmosphere and land had also lead to the poor yield. Regarding these problems a methodical systematic research has not been



carried out by any one. It is unfortunate that the environmental pollution has in fact disturbed heavily the ecological system. An integrated study is lacking in India. However in this book we are going to study the biotechnology in agriculture and water resources, use of pesticides and insecticides and environmental pollution by chemical plants and give some suggestions to prevent it. We mainly use fuzzy models to analyse the problems. We give some instances or models using which the pollution of the environment can at least be minimized.

As India happens to continue to be a developing country, the situation is less encouraging where financing is limited or not available for the construction of water and waste treatment facilities and there is a shortage in trained personal to operate the systems. Further more in India there is a lack of official regulations and control systems, and no administration bodies responsible for waste control and little obligation for existing and emerging industries to dispose of waste properly. Also it is so much so in India that there is a greatest movement towards urbanization and new industrial developments, with concomitant destruction of environment.

Waste generation is a side effect of consumption and production activities and tends to rise with the level of economic advance. Waste arise from domestic and industrial activity, example; sewage waste waters, agriculture and food wastes from processing, wood wastes and an ever increasing range of toxins from industrial chemical products and byproducts. Above all in India even the waste from the hospitals are not treated properly which has resulted in several severe problems on animals and rag pickers. In the final assessment the wastes represented the end of the technical and economic life of products. Costs for properly dealing with wastes are escalating and much attention is not given uniformly, only when serious problems they think about it; for instance the dying units in the year 2005 due to the environmental pollution caused the death of 120 tonnes of fish and very many lakhs of crops and so on. Only when such damages take place they go to court for closing down of these units. Why the government has not taken any analysis of waste management before the sanction was given to the construction of these industries? The only answer which one

can receive is the careless attitude of the politicians and those in power; for they plan only about the monetary benefit they get by the sanction of such industries and nothing more. As there is no waste management engineers to work on the types of wastes these industries would create and their treatment at the time of planning for the industry; that is why now experts from western countries like France are invited to treat the wastes so that they do not damage the environment. This is just an instance to show how tragic is the growth of these industries when no proper contemplation is made about the waste management of these industries, as in the final assessment waste represents the end of the technical and economic life of products. In India in most of the cases when they set up an industry they do not give any importance to the wastes created by it be it chemical or otherwise.

Costs for properly dealing with wastes are escalating and much attention is presently devoted to efficient and effective waste management, which will include costs of collection, storage, processing and removal of wastes. The most disgusting factor in India is the aspect of pollution is the increasing presence of toxic chemicals in the natural environment. The large scale production and application of synthetic chemicals and their subsequent pollution of the environment is now a problem of serious concern in India; for the recycling of it or proper disposal of it without harming the self-regulating capacity of the biosphere in which we live is not properly programmed or even contemplated. It is not too much to say in this context that we are digging our own graves. For the ecosystem of India is largely affected which is evidenced by failure of monsoon, death or annihilation of many precious species that seasonally existed and used by the locals as seasonal food, on set of sudden cyclones, tsunamis, floods and earth quakes.

India is to learn a great lesson over this by a practical study, for bench work in a sophisticated room by sophisticated intellectuals cannot give any proper solution. Already the use of chemical fertilizers have resulted in the death of many edible seasonal species in India; this was confirmed from the local during the field interviews carried out by us. All these have

finally resulted in the health condition of the rural Indians, who do not have proper or adequate medical facilities. No laws can be made to solve this problem of environmental pollution by the chemical industries, as loop holes to escape at each stage and bribery, form the major art of the industrialists to continue with the running of the faulty industries. Further these flourishing industries are not going to make India a developed country, but only make a group of people become rich, consequent of which they become powerful politically and legally. Until attitude of these people are changed it is impossible to see India as a developed nation. For self importance and self development at the cost of the nation is dominant in most of the industrialists in India.

Many toxic and hazardous chemicals are entering a variety of environments. These synthetic compounds can be found at very high concentrations at the point of discharge such as factory sites and industrial spillages where they can exert pronounced deleterious effects, where as others occur at low levels in natural environments, but because of their inherent toxicity like pesticide dioxin constitute a serious health hazard. Further in many parts of India there is an increasing evidence of under ground water sources showing dangerous levels of contamination.

Environmental biotechnology is a discipline that studies the application of biological systems and processes in waste treatment and management. Here in this book we give methods by which the environmental pollution can be reduced. We use fuzzy tools like fuzzy control theory, hierarchical genetic fuzzy control, Fuzzy Associative Memories (FAM) and Refined Time Dependent (RTD) matrices. It is unfortunate in India till date not many successful biotechnological process have not been developed even for water, gas, soil and solid waste treatments. It is depressing in India when some form of compromise is made about the environmental pollution, that is, the environmentalists use the term, “pollution is optimal or tolerable”; but for” how many years?” any sensitive environmentalist will ask. The reader is expected to be familiar with fuzzy models used in this book. For more please refer [21, 40, 49, 55-6, 61, 63].

## Chapter Two

# USE OF FAM MODELS TO ANALYSE THE POLLUTION CAUSED BY THE GARMENT INDUSTRIES

In this analysis we do not discuss about types of garment production, labour situation and wages, labour relations, employers, labour inspection, labour laws and acts, payment of a living wage, exploitation of child labour, discrimination in employment, excessive working hours, health and safety, legally bidding employment relationship or trade unions role. We only study the environmental pollution by these industries, ground water pollution, river pollution and atmospheric pollution and its evil effects on locals and labourers. We study only the effects of pollution and how to control it. Is the only solution lie in closing down of these plants?

The problems of pollution leading to health hazards and hazarderous diseases, the future population has chances of suffering genetic disorders, malformed children, etc all types of new health problems which may be very new to the world. The vegetation in that area has been very badly affected and we see even the bringing up of the domestic animals has become a problem. Since we cannot exactly say the exact percentage of chemicals found in the waste water or we are not in any way able to say precisely the percentage of hazarderous gas let out into the atmosphere only; these short comings has forced us to study this problem only with opinion of the experts. Only when we have a past data we can use neural networks or fuzzy control theory.

By 1992 the government of Tamil Nadu had built the Orathapalayam dam about 10 km down stream from Tirupur for irrigating 8000 ha. The Dam's catchment is 2245 sq. km. and includes most of the area in which the bleaching and dyeing units are located. Noyyal river joins Cauvery about 32 km. downstream from the dam.

The number of knitting mills in Tirupur went from 22 in 1941 to 2800 in 1991. Similarly while there were hardly any dying and bleaching units in 1940's the Tamil Nadu Pollution Control Board indicates that 752 were in operation in 1996. In addition, many unregistered units were in operation. The direct export value of the hosiery products from Tirupur has gone up from Rs.190 million in 1985 to Rs.20 billion in 1996. Dyeing and bleaching are important part of knit wear production, requiring enormous quantity of clean water. Estimated quantity of effluent from Tirupur units is 94 mld, almost all going to Noyyal river and ending up in the Orathapalayam Dam. As Dr. S. Janakarajan from Madras Institute of Development studies notes the Orathapalayam dam has never functioned well as an irrigation reservoir. It has become a storage for the pollution from Tirupur and contributes significantly to pollution of the environment particulary ground water.

In February 1997, when effluents collected in Orathapalayam Dam was released considerable damage to crops, animals, soils and ground water resulted both along the Noyyal river and further along the Cauvery River.

Several hundred animals collapsed after drinking the water and petitions were filed in the High Court against release of polluted water. The Tamil Nadu government had to release 20000 cusecs of water from the Mettur dam upstream to dilute the pollution.

Dr. Janakarajan notes that before construction of the dam agricultural production was high. Not only rainfed cultivation is carried out in this area. The ground water is so polluted that it is unfit even upto the depth of 300 ft.

Dam may collapse due to seepage. The dam constructed in 1963 has 344 inspection hols, which were designed for the protection of dam wall of which two third are choked due to silt. The cracks appeared on the wall are widening and water has started to seep.

The dyeing and bleaching plants use approximately 60, 000 kilograms of chemicals per day and most wastes are simply released into water. The Tamil Nadu pollution Control Board some times takes action against polluters; as a result 240 dying and bleaching plants have installed water purification systems but these are inadequate. Water samples taken from the Noyyal river for example, showed extremely high incidences of substances such as chlorine, chloride, calcium, magnesium, sodium and potassium thus making river water and ground water unfit for drinking. A number of these substances can be traced directly to the dyeing and bleaching plants. Excessive amounts of chloride negatively affect the human reproduction system, intestines and nervous system. Too much calcium can cause kidney stones, discolouration of teeth and disturb the body's ability to make use of vitamins. In addition there is far too little drinking water available. The vast majority of clothing company employees only receive 20 liters per week of drinking water, if it can be recalled that, the water may have a white, red, blue or black tint and is sometimes contaminated with worms or salt. Government distribution is inadequate, so most people have to buy their own water from private enterprises. Farmers suffer because there is no longer enough water to irrigate their fields something which was never a problem in the past.

The dyeing and bleaching plants also have a high demand for energy. These 800 companies use about 15 million

kilograms of wood per day. This contributes to area deforestation and also generates huge amounts of CO<sub>2</sub> exhaust a major cause of climate change. Gases released from chimneys and chemical fumes cause even more problems as well as the incineration of wastes (often toxic) by clothing companies. Area residents often suffer from eye irritation, headaches and respiratory ailments.

India Alarm # 83, Sep. 2002

Baby clothes from Vendex KBB cause environmental pollution in India;

<http://www.pz.nl/AKB/>

<http://www.cleanclothes.org/nlindex.html>

<http://www.indianet.nl/index.html>.

We study only the environmental pollution aspect and no other aspects like labour problem, work place security, pay, or pension, holiday benefits etc. However we are forced to study migrants problem as due to migration more slums are created which have no proper sanitary facilities leading to environmental pollution! Here the environmental pollution cannot be controlled as the dying industry owners feels that it is very expensive to treat the waste i.e., “reverse osmosis”(RO). They are so selfish to understand or give a moment of reflection over the environmental pollution that too death of hundreds of tones of fish, damage to crops in tune of lakhs, pollution of ground water, up to 300 ft and the damage done to the dam on Noyyal and so on. Court has ordered for the closure after several representations. The damage so far done to the soil, ground water and vegetation is irreparable. However the impact of this in the human life is still going to be very dangerous for this can give genetically disordered generation which cannot easily be rectified. Water in this area is full of chemicals and that is hazarderous to the health. The only way to stop further environmental pollution is the closing of those dying units which does not have RO’s. No mercy should be shown. Also the soil should be treated and proper methods should be adopted to purify the ground water. The crowding of slums should be sorted out. Proper house should be built to the labourers with

good toilet facilities. Unless such things are carried out India is leading to a environmental chaotic conditions and the natural disaster is certain. This is the main view of almost all the experts.

Now, we have used experts who are NGOs,  $V_1$ , socio scientists,  $V_2$ , environmentalists  $V_3$ , labourers of Tirupur industries,  $V_4$ , locals and farmers of Tirupur  $V_5$ , Trade unions leaders  $V_6$ .

Each of the six groups contributed their opinions on the following eight issues.

$C_1$  - Monsoon failure and climatic changes due to deforestation as these dyeing and bleaching plants numbering about 800 companies use 15 million kilograms of wood per day which also generates huge amounts of  $CO_2$  exhaust.

This results in pollution of the atmosphere causing agriculture failure and health hazards viz eye irritation, headaches and respiratory ailments.

$C_2$  - Agricultural failure due to  $C_1$  as well as the land and water is unfit for irrigation. This was never a problem before only now farmers are subjected to scarcity of water.

$C_3$  - Water has become scarce due to over population in that area most of whom are migrant labourers who are forced to find housing in the slums within the city.

$C_4$  - These dyeing and bleaching plants use approximately 60, 000 kilograms of chemicals per day and most wastes are released in water, which has polluted the Noyyal river.

$C_5$  - The high presence of substances like chlorine, chloride, calcium, magnesium, sodium and potassium has made the river water and ground water unfit for drinking and agriculture.

$C_6$  - In view of  $C_5$  there is risk on the locals to develop problems like nervous disorder, problems of the reproduction system, kidney stones and over all disturbances of the body's ability to function normally.



- C<sub>7</sub> - The company employees get only 20 liters of drinking water per week which is red or white or black or blue in tint, contaminated with worm or salt.
- C<sub>8</sub> - Most of these problems are due to the fact they have not installed proper water purification centers.

The following suggestions were given by them.

1. Closure of all those bleaching and dyeing plants if RO (Reverse Osmosis) is not properly implemented.
2. To cut down the use of chemicals so that the atmospheric pollution may be lessened in every day as chemical fumes and CO<sub>2</sub> exhaust.
3. Make other alternative methods for fuel so that deforestation is reduced.
4. The pollution of Noyyol river is unpardonable so these dyeing and bleaching industries can be closed down, which do into have RO unit.
5. These industries which make money in crores are least bothered about the environment or locals or the farmers.
6. Public construe the heartlessness of these industrialists is due to the secret support they receive from those politicians and courts, who are only after money.
7. Now before the pollution of ground water and before the construction of the dam the agricultural production was high.
8. Foreign companies enjoy the product at the cost of environmental pollution which may result in precarious diseases and genetic disorders in the natives or locals of Tirupur, so closure is the only solution.
9. Due to migration Tirupur faces the dreaded diseases like HIV/AIDS, malaria cancer, Tuberculosis, dengue fever, skin diseases, hepatitis and asthma.
10. Is it in any way justifiable that process waste water of 90 million liters per day which is letout in the environment has made ground water unusable is worth the “valuable” foreign exchange. What is the cost of environmental pollution and its effects on the locals and farmers?
11. It is mentioned that these industrialists buy annually water for 7 million US dollars so they think cost of effluent

treatment plant would be a burden – In such case let them close down the industries.

12. The calorific value of the municipal solid waste (garbage) was high as it contained large quantities of textile and paper wastes. It was suggested that these wastes can be used for fire wood atleast to some extent.
13. It is the right of every citizen to get proper drinking water and unpolluted air to breathe and it is the duty of the government to provide this irrespective of caste, creed and economic status. In such a case the people are suffering for drinking water.
14. The owners of the bleaching and dyeing industry should pay appropriate damages to farmers.
15. It is a pity if the government permits the rich industrialists to buy the near by land and use it to store the waste water as the seepage of the water will not only pollute the already polluted ground water but this will lead to the genetic disorders and unheard and unseen diseases, ultimately ruining the poor locals and the migrant labourers.
16. A team of honest doctors must be appointed to study the heath problems of the people living in Tirupur and their blood samples must be studied.
17. The industrialists of Tirupur should not hesitate to pay any amount for the purification and treatment of waste water. If they do not do this minimum the government and the court should order for the closure of all these plants.
18. The government should stop the supply of electricity. They can provide electricity on alternate days only for 5 hours maximum which would automatically reduce the waste water from crores liters to 2.10 crores liters and try to treat this 2.10 crores liters waste water properly. Unless such stern steps are taken it is impossible to control the environmental pollution.

Several other concepts were given by the experts, since they were not voiced by the majority we have enlisted them in the section on observations and suggestions.

We had taken the views of 12 NGOs. They were asked to give the relation between the concepts  $C_1, \dots, C_8$  and the

suggestions 1 to 18 in the scale [0, 1]. Then each of the 12 views on each interrelation was added and divided by 12 to obtain the (Fuzzy Associative Memories) FAM model. For information regarding FAM refer [21, 53]. We take only upto two decimal places. The  $8 \times 18$  matrix  $M_1$  associated with the FAM fuzzy vector matrix.

The related fuzzy vector matrix  $M_1$  of the NGOs is as follows.

	$C_1$	$C_2$	$C_3$	$C_4$	$C_5$	$C_6$	$C_7$	$C_8$
1	0	0.6	0	0.5	0.8	0.7	0.6	0.7
2	0.91	0	0	0.6	0.7	0.6	0	0.5
3	0.8	0	0	0	0	0	0	0
4	0	0.7	0	0.8	0.6	0.5	0.7	0.6
5	0	0.5	0	0	0.4	0.4	0.4	0.8
6	0.2	0	0	0	0.1	0.2	0	0.2
7	0.8	0.6	0	0.6	0.8	0	0	0.7
8	0	0	0	0	0.5	0.8	0.6	0.7
9	0	0	0.9	0	0.6	0.7	0.8	0.6
10	0	0.7	0.6	0.7	0.6	0.7	0.6	0.8
11	0	0	0	0	0	0.3	0.4	0
12	0.6	0	0	0	0	0	0	0.1
13	0	0	0.2	0.3	0.5	0.4	0.8	0.9
14	0	0.6	0	0	0	0.1	0	0
15	0	0	0.8	0.6	0.5	0.8	0.5	0.7
16	0	0	0.4	0.5	0.6	0.7	0.6	0.5
17	0	0	0	0.5	0.4	0.5	0.6	0.8
18	0	0	0	0.6	0.5	0.3	0.5	0.6

Suppose the expert wishes to work with the fit vector  $X = (1 \ 0 \ 0 \ 0 \ 1 \ 0 \ 0 \ 0 \ 0 \ 0 \ 0 \ 0 \ 0 \ 0 \ 0 \ 0 \ 0 \ 0 \ 1)$ . Using max-min in backward direction we get

$$\begin{aligned}
 Y &= X \circ M_1 \\
 &= (0, 0.6, 0, 0.6, 0.8, 0.7, 0.6, 0.8).
 \end{aligned}$$

Now

$$\begin{aligned}
 Y \circ M_1^t &= (0.8, 0.7, 0, 0.6, 0.8, 0.2, 0.8, 0.7, 0.7, 0.8, 0.4, \\
 &\quad 0.1, 0.8, 0.6, 0.7, 0.7, 0.8, 0.6).
 \end{aligned}$$

When in the fit vector the expert takes the nodes (1), (5) and (18) to be in the on state, i.e., closure of all these dying plants if RO is not properly implemented (5) these industries which make money in crores are least bothered about environment or locals or the farmers and (18); the government should stop the supply of electricity or provide only on alternate days that too only 5 hours maximum which would reduce the waste water and reduce the environmental pollution. The resultant gave maximum value of 0.8 to the notes  $C_5$  and  $C_8$ . The high presence of chemicals had made the ground water unfit for drinking and most of these problems are due to the fact they have not installed proper waste purification centres, followed by  $C_6$  getting its value to be 0.7 i.e., the risk of the locals developing health hazards mentioned in  $C_6$  followed by the value 0.6 for the nodes  $C_2$ ,  $C_4$  and  $C_7$  i.e., agriculture failure is due to pollution of land and water, these wastes got after using 60000 kilograms of chemicals have polluted the Noyyal river and unfortunately the employees get 20 litres of drinking water for a week that too contaminated water. Only the nodes  $C_1$  and  $C_3$  are in the zero state i.e. deforestation and scarcity of water is not linked with closure of these units if RO is not implemented, these industries which make money in crores are least bothered about environment locals or farmer and government cut shorting electricity to these industries.

But however these three nodes had made (1), (5), (7), (10), (13) and (17) to get an highest value of 0.8 i.e., these nodes highly affect the agricultural production, environmental pollution at the cost locals and farmers and the industrialists should not mind spend any amount for waste water treatment otherwise order for closure of these plants. However the next highest value viz. 0.7 was taken by the nodes (2), (8), (9), (15) and (16).

To cut down chemical pollution by cutting down the use of chemicals since it is possible for the locals of Tirupur to get precarious diseases like genetic disorder etc., it is better to close down these plants. Due to migration the Tirupur faces dreaded diseases like HIV/AIDS malaria is of concern etc.

It is right of every citizen to get proper drinking water and unpolluted air to breathe. It is the duty of the government to provide them irrespective of caste, creed and economic status get 0.8 the maximum value. It is a pity if the government permits the rich industrialist to buy the land and pollute it and a team of honest doctors must be appointed to study the health problems of the people living in Tirupur and their blood samples must be studied.

The only node that takes zero is the 3<sup>rd</sup> node which says make other alternative methods for fuel so that deforestation is reduced.

The least value 0.1 is taken by the 12<sup>th</sup> node which say the calorific value of the municipal solid waste (garbage) was high as it contained large quantities of textile and paper waste which could be used as fuel to reduce the deforestation. The next minimal value being 0.2 taken by coordinate (6) i.e., they are not very sure whether the politicians have taken money from the industrialists and remaining silent.

Suppose only the node that the plant owners have not installed proper waste water purification centres is in the on state, taken as the fit vector. Let  $A = (0\ 0\ 0\ 0\ 0\ 0\ 0\ 1)$ ; to study the effect of  $A$  on the system.

$$\begin{aligned} A \circ M_1^t &= (0.7, 0.5, 0, 0.6, 0.8, 0.2, 0.7, 0.7, 0.6, 0.8, 0, 0.1, \\ &\quad 0.9, 0, 0.7, 0.5, 0.8, 0.6) \\ &= B. \\ B \circ M_1 &= (0.7, 0.7, 0.7, 0.7, 0.7, 0.7, 0.7, 0.8). \end{aligned}$$

We see the on state of the node  $C_8$  i.e., when the fit vector  $A = (0\ 0\ 0\ 0\ 0\ 0\ 0\ 1)$  i.e., most of the problems are due to the fact they have not installed proper water purification centres all the nodes  $C_1, C_2, C_3, C_4, C_5, C_6$  and  $C_7$  take the same value 0.7.

In the resultant when  $C_8$  is in the on state in the fit vector we see (5), (10) and (17) take the next maximum value 0.8 by which it is to be notes that these industries which make money



Finally we work with the fit vector  $A = (0\ 0\ 0\ 0\ 0\ 0\ 0\ 1\ 1\ 1\ 0\ 0\ 0\ 0\ 0\ 0\ 0)$

$$\begin{aligned}
 A \circ M_1 &= (0, 0.7, 0.9, 0.7, 0.6, 0.8, 0.8, 0.8) \\
 &= B \\
 B \circ M_1^t &= (0.7, 0.6, 0, 0.7, 0.8, 0.2, 0.7, 0.8, 0.9, 0.8, 0.4, \\
 &\quad 0.1, 0.8, 0.6, 0.8, 0.7, 0.8, 0.6).
 \end{aligned}$$

The value 0.9 being the highest is taken by the nodes  $C_3$  and (9) which means water become scare due to migration; which is due over population and due to migration Tirupur faces dreaded diseases like HIV/AIDS, TB etc respectively.

The next higher value is taken by the nodes  $C_6, C_7$  and  $C_8$  and (5), (8), (10), (13), (14) and (17) the corresponding nodes imply. In view of  $C_6$  the locals have the risk of developing nervous disorder, reproduction problems and kidney stones. The company just gives 20 liters of polluted drinking water to the workers for a week and all these problems are due to the fact that the industries are not equipped with proper water purification centres. Further these industries which make money in crores is least bothered about the environmental risks or locals or farmers, closure of these industries alone is the only suggestion as in due course of time the environmental pollution may result in genetic disorders of workers and the natives of Tirupur.

The 90 million liters of waste water per day is let out in the environment which has lead to the pollution of ground water. The very right of every citizen to get proper drinking water and unpolluted air is flouted, (14) the owners/government must pay appropriate damages for making agriculture a failure(17). The industrialist should not hesitate to pay any amount to set up a proper waste water purification unit.

Now we proceed onto give the views of socio scientists. Nineteen socio scientists gave their views about the environmental risks due to the Tirupur dying industries.

As in case of NGOs the views are the mean of the 19 experts and get the  $18 \times 8$  matrix  $M_2$  associated with the FAM model.

	C <sub>1</sub>	C <sub>2</sub>	C <sub>3</sub>	C <sub>4</sub>	C <sub>5</sub>	C <sub>6</sub>	C <sub>7</sub>	C <sub>8</sub>
1	0	0.8	0.2	0.8	0.7	0.6	0.3	0.8
2	0.7	0	0	0.7	0.8	0.7	0	0.2
3	0.9	0	0	0	0	0	0	0
4	0	0.7	0	0.9	0.8	0.6	0.5	0.7
5	0	0.6	0.7	0.6	0.7	0.7	0.6	0.7
6	0	0	0	0	0	0	0.2	0.5
7	0.7	0.8	0	0.7	0.8	0	0	0.6
8	0	0	0	0.8	0	0.8	0.7	0.8
9	0	0	0.8	0	0	0.7	0.6	0.3
10	0	0.8	0.7	0.8	0.6	0.6	0.1	0.5
11	0	0.3	0.4	0.3	0.8	0	0.6	0.7
12	0.7	0.4	0	0	0	0	0	0.5
13	0	0	0.7	0	0.6	0.5	0.8	0.9
14	0.6	0.7	0	0	0	0	0	0.6
15	0.5	0.6	0	0.7	0.6	0.8	0	0.7
16	0.7	0	0	0	0	0.7	0.5	0.8
17	0	0.2	0	0.5	0.2	0	0.1	0.7
18	0	0.2	0.3	0	0	0	0	0.6

We take the same fit vectors as that of the NGO's so that we can compare the results / opinions of the NGO's with the social scientists.

Suppose we wish to work with the same fit vector  $X = (1 \ 0 \ 0 \ 0 \ 1 \ 0 \ 0 \ 0 \ 0 \ 0 \ 0 \ 0 \ 0 \ 0 \ 0 \ 0 \ 0 \ 1)$ . Using max-min in the backward direction we get

$$\begin{aligned}
 Y &= X \circ M_2 \\
 &= (0, 0.8, 0.7, 0.8, 0.7, 0.7, 0.6, 0.8) \\
 Y \circ M_2^T &= (0.8, 0.7, 0, 0.8, 0.7, 0.5, 0.8, 0.8, 0.7, 0.8, 0.7, \\
 &\quad 0.5, 0.8, 0.7, 0.7, 0.8, 0.7, 0.6) \\
 &= X_1.
 \end{aligned}$$

The maximum value of 0.8 is obtained by the nodes C<sub>2</sub>, C<sub>4</sub> and C<sub>8</sub>. The socio scientists agree agriculture failure is due to





0 0 0 0 0) taken by the NGO's. The effect of A on the dynamical system  $M_2^T$  is given by

$$A \circ M_2 = (0.9, 0, 0, 0.7, 0.8, 0.7, 0, 0.2) \\ = B.$$

As in case of NGOs maximum value is taken by  $C_1$  and  $C_2$ ,  $C_3$  and  $C_7$  are zero. The next higher value 0.8 is taken by  $C_5$  followed by  $C_4$  and  $C_6$ . The least non zero value 0.2 is taken by  $C_8$ .

$$B \circ M_2^T = (0.7, 0.8, 0.9, 0.8, 0.7, 0.2, 0.8, 0.7, 0.7, 0.7, \\ 0.8, 0.7, 0.6, 0.6, 0.7, 0.7, 0.5, 0.2).$$

The highest value 0.9 is taken by the node (3) i.e., the socio scientists feel one can think of alternative arrangements for fuel. The next higher value is 0.8, taken by the nodes (2), (4), (7) and (11). i.e., this group of experts believe in cut down in the use of chemicals which can certainly lessen the pollution. But the pollution of Noyyal river so suggest close down of those plants which has no RO units. They feel due to pollution agriculture yield has come down drastically and finally they accept that the industrialists buy water for 7 million US dollars every year so they feel the cost of effluent treatment would be a burdon under these circumstances the experts suggest the closing down of these plants to be the best solution.

The next higher value 0.7 is taken by the nodes 1, 5, 8, 9, 10, 12, 15 and 16.

The lowest value being taken by the nodes (6) and (18). The experts don't feel the hands of politicians but support the supply of electricity on alternate days that too only for 5 hours a day.

Finally as in case of NGO's we consider the fit vector  $A = (0\ 0\ 0\ 0\ 0\ 0\ 0\ 1\ 1\ 1\ 0\ 0\ 0\ 0\ 0\ 0\ 0\ 0)$ .

$$A \circ M_2 = (0, 0.8, 0.8, 0.8, 0.6, 0.8, 0.7, 0.8) = B. \\ B \circ M_2^T = (0.8, 0.7, 0.8, 0.8, 0.7, 0.5, 0.8, 0.8, 0.8, 0.8, \\ 0.7, 0.5, 0.8, 0.7, 0.8, 0.8, 0.7, 0.6) = C.$$

Now we see the maximum value of 0.8 is received at the nodes (1), (3), (4), (7), (8), (9), (10), (13), (15) and (16). The next higher value is 0.7 taken by (2), (5), (11), (14) and (17). The least value 0.5 is taken by the nodes (6) and (12). We see the socio scientists feel that public construe that they (industrialist)

get secret support from the politicians. The alternate use of the garbage and paper waste as fuel can lessen the deforestation!

The socio scientists feel out of 18 nodes ten nodes get the highest value 0.8, i.e., when the nodes 8, 9, and 10 are in the on state; closure is the only solution for the environmental pollution. Due to migration the Tirupur people have the chance of getting the dreaded diseases like HIV/AIDS.... Finally the question “is the foreign exchange worth the cost of environmental pollution and the bad effects of locals and farmers due to the waste water amounting to 90 million liters per day let out in to the environment.

We next give the opinion of 8 environmentalists, the related matrix of the FAM is  $M_3$  given below.

	$C_1$	$C_2$	$C_3$	$C_4$	$C_5$	$C_6$	$C_7$	$C_8$
1	0	0.8	0	0.7	0.8	0.8	0.5	0.8
2	0.6	0.2	0	0.6	0.7	0.6	0	0
3	0.5	0.7	0	0	0	0	0	0
4	0	0.6	0	0.5	0	0	0	0.6
5	0.8	0.3	0	0.7	0.6	0.5	0.4	0.8
6	0	0	0	0	0	0	0	0
7	0.3	0.7	0	0.4	0.5	0.3	0.1	0.7
8	0	0.6	0.5	0.8	0.7	0.8	0.5	0.8
9	0	0	0.8	0	0	0.7	0.5	0.7
10	0.6	0.8	0	0.9	0.8	0.7	0.6	0.8
11	0	0.5	0	0.8	0.8	0.6	0.2	0.8
12	0.8	0	0	0	0	0	0	0
13	0	0.7	0.6	0.6	0.7	0.6	0.7	0.8
14	0.5	0	0	0	0	0.4	0	0.6
15	0	0.7	0	0.7	0.6	0.8	0.6	0.7
16	0.6	0	0	0	0	0.7	0.5	0
17	0	0.6	0	0.7	0	0	0	0.8
18	0.6	0.5	0.7	0.6	0	0	0	0.7

We work only with the fit vectors used in the case of NGO's and socio scientists only for this will enable us to compare the results.

Let  $X = (1\ 0\ 0\ 0\ 1\ 0\ 0\ 0\ 0\ 0\ 0\ 0\ 0\ 0\ 0\ 0\ 0\ 1)$  be the fit vector.

$$\begin{aligned} X \circ M_3 &= (0.8, 0.8, 0.7, 0.7, 0.8, 0.8, 0.5, 0.8) \\ &= B \text{ (say)} \\ B \circ M_3^T &= (0.8, 0.7, 0.7, 0.6, 0.8, 0, 0.7, 0.8, 0.7, 0.8, 0.8, \\ &\quad 0.8, 0.8, 0.6, 0.8, 0.7, 0.8, 0.7) \\ &= C. \end{aligned}$$

The maximum value 0.8 is taken by the nodes  $C_1, C_2, C_5, C_6$  and  $C_8$ . Now when we study the resultant  $C$  of the system we see the maximum value is 0.8 taken by the nodes (1), (5), (8), (10), (11), (12), (13), (15) and (17). However the zero value is taken by the node (6) ie the environmentalists do not construe the hand of the politicians in the environmental pollution. The next higher value being 0.7 is taken by the nodes (3), (2) (7), (9), (16) and (18). All the values barring the zero value of (6) the rest of the values are greater than 0.5. Thus the environmentalists view the risk as high that is why all values are greater than or equal to 0.6.

Suppose  $A = (0\ 0\ 0\ 0\ 0\ 0\ 0\ 1)$  is the given fit vector.

$$\begin{aligned} A \circ M_3^T &= (0.8, 0, 0, 0.6, 0.8, 0, 0.7, 0.8, 0.7, 0.8, 0.8, 0, \\ &\quad 0.8, 0.6, 0.7, 0, 0.8, 0.7) \\ &= B. \\ B \circ M_3 &= (0.8, 0.8, 0.7, 0.8, 0.8, 0.8, 0.6, 0.8) \\ &= C \end{aligned}$$

Now we analyze the resultants  $B$  and  $C$ .

The maximum value 0.8 in  $B$  taken by the nodes (1), (5), (8), (10), (11), (13) and (17).

However the zero value is taken by the nodes (2), (3), (6), (12) and (16). Unlike the NGO's and the socio scientists the environmentalists feel cutting down of chemicals cannot stop the atmospheric pollution, alternative methods is of no use, public construe that the industrialists have bribed the politicians so only no action. The solid waste can be used as fuel; study of the health problem by doctors take zero value when the on state of the node (8) alone was taken in the fit vector ie. "Most of the

problem are due to the fact these units don't have proper waste water purification units".

This node has no relevance to (2), (3), (6), (12) and (16).

All the other nodes take values greater than or equal to 0.6. Now the highest value in the resultant vector C are taken by the nodes  $C_1, C_2, C_4, C_5, C_6$  and  $C_8$ .

The next higher value is taken by  $C_3$  and the least value 0.6 is taken by  $C_7$ . When the industry does not possess a proper waste water purification unit, the atmospheric pollution is high, under ground water is unfit for irrigation. The 60, 000 kg of chemicals are found in the ground water leading to series of health hazards.

Consider the fit vector  $A = (0\ 0\ 0\ 0\ 0\ 0\ 0\ 1\ 1\ 1\ 1\ 0\ 0\ 0\ 0\ 0\ 0\ 0\ 0)$

$$A \circ M_3 = (0.6, 0.8, 0.8, 0.9, 0.8, 0.8, 0.6, 0.8) \\ = B.$$

$$B \circ M_3^T = (0.8, 0.7, 0.7, 0.6, 0.8, 0, 0.7, 0.8, 0.8, 0.9, 0.8, \\ 0.6, 0.8, 0.6, 0.8, 0.7, 0.8, 0.7) \\ = C.$$

The maximum value 0.9 is taken by the node  $C_4$  followed by the next higher value 0.8 by the nodes  $C_2, C_3, C_5, C_6$  and  $C_8$ . The environmentalists feel that the 60, 000 kg of chemicals used every day has polluted the Noyyal river.

Like wise the highest value 0.9 is taken by the node by (10) that the environmental pollution is in no way proportion to the foreign exchange the government gets. The next higher value 0.8 is taken by the nodes (1), (5), (8), (9), (11), (13) (15) and (17). However the zero value is taken by the node (6) the public construe the heartlessness of these industrialists is due the secret support they receive from those politicians who are after money.

The least value being 0.6 is taken by the nodes (4), (12) and (14). 34 labourers working in different industries in Tirupur gave their opinion about the problems of pollution due to the Tirupur bleaching and dyeing industries. We have taken the opinion of the 34 of them and have taken the mean of it, so that the value once again lies in the interval  $[0, 1]$ . Thus we can adopt the same FAM model and denote the related matrix by  $M_4$ .

	$C_1$	$C_2$	$C_3$	$C_4$	$C_5$	$C_6$	$C_7$	$C_8$
1	0	0	0.6	0.1	0.2	0.4	0.8	0.1
2	0	0	0	0	0	0	0	0
3	0	0	0	0	0	0	0	0
4	0	0	0	0	0	0	0	0
5	0	0	0	0	0	0.1	0.2	0.1
6	0.1	0	0	0.2	0.3	0.5	0.7	0.2
7	0.2	0.1	0	0	0	0.1	0.3	0.2
8	0.3	0	0.3	0	0	0.2	0.6	0.1
9	0.5	0	0	0	0	0.5	0.4	0.1
10	0	0.1	0.3	0	0	0	0.7	0.2
11	0	0	0	0	0	0	0.6	0
12	0	0	0	0	0	0	0	0
13	0	0	0.2	0	0	0	0.8	0
14	0	0	0	0	0.3	0.2	0.6	0.2
15	0	0	0	0	0	0	0	0
16	0	0	0	0	0	0	0	0
17	0	0.8	0	0	0	0	0.5	0.1
18	0	0	0	0	0	0	0	0

It is important for the authors at this juncture to keep on record that getting their (labourers) view was the difficult task as they never wished to speak about their industry in the first place, secondly they were constantly fear gripped to make any statement about their company as closure or supply / cut of only half electricity and so on. However they very freely blamed the government and politicians. Under these stressful circumstances it was infact a herculean task to meet them and make them talk.

Further they were very much bothered about both the quality and the quantity of water they got for a week which was very difficult for them. Now we make use of the same set of fit vectors and study the resultant. Let  $X = (1\ 0\ 0\ 0\ 1\ 0\ 0\ 0\ 0\ 0\ 0\ 0\ 0\ 0\ 0\ 0\ 0\ 0\ 0\ 0\ 1)$  be the given fit vector.

$$\begin{aligned}
X \circ M_4 &= (0, 0, 0.6, 0.1, 0.2, 0.4, 0.8, 0.1) = Y \\
Y \circ M_4^T &= (0.8, 0, 0, 0, 0.2, 0.7, 0.3, 0.6, 0.5, 0.7, 0.6, 0, \\
&\quad 0.8, 0.6, 0, 0, 0.5, 0) = P.
\end{aligned}$$

Now we analyse P and Y.

The maximum value 0.8 is taken by the node  $C_7$  followed by the node  $C_3$ . The labourers feel water supplied to them is too impure that too only 20 litres per week feel they due to migrant labourers only they are having scarcity of water.

It is a surprise to see the nodes  $C_1$  and  $C_2$  and zero. The nodes (1) and (13) alone get the highest value viz. 0.8 i.e

(1) closure of those units in which RO is not properly implemented and (13) it is the right of every citizen to get proper drinking water and unpolluted air to breathe. The nodes (2), (3), (4), (12), (15), (16) and (18) receive only zero value i.e., the labourers are unconcerned about (1) cutting down of chemicals so that atmospheric pollution is lessened. (3) making alterative arrangements for fuel, (4) least bothered about the pollution of Noyyal river. (12) the calorific value of the municipal solid waste is very high and it can be used for fire wood, (15) it is a pity that the government is permitting them to buy land near the industries for storing the waste water.

(16) A team of doctors must be appointed to study the health problems and blood samples of the people living in and around Tirupur (18). Finally they are not for the supply of electricity only for alternate days. Thus the views of labourers of Tirupur industries happen to be very much different from others. All these nodes which was found to be significant happened to be treated as insignificant by these labourers, as these nodes, are zero in the resultant. A least non zero value if 0.2 is taken by the node (5) i.e., these industries which make money in hundred of crores is unconcerned about the environment or locals or farmers. Yet the node (7) receives a value 0.3 i.e., the production of agriculture was high before the pollution of the ground water and the construction of the dam over the Noyyal river. Next we find the resultant of the fit vector  $A = (0\ 0\ 0\ 0\ 0\ 0\ 0\ 1)$  Now  $A \circ M_4^T = (0\ 0\ 0\ 0\ 0\ 0\ 0\ 0\ 0\ 0\ 0\ 0\ 0\ 0\ 0\ 0\ 0\ 0)$ . That the labourers alone feel that the problems are due to the fact that the industries have not built a proper RO unit does give a zero resultant which is surprising to one and all.

The authors put forth only the question that are the labourers so much frightened of loosing their jobs they ignore or act to ignore the real problems created by these industries.

Finally we study with the fit vector  $A = (0\ 0\ 0\ 0\ 0\ 0\ 0\ 1\ 1\ 1\ 0\ 0\ 0\ 0\ 0\ 0\ 0\ 0)$ .

$$A \circ M_4 = (0.5, 0.1, 0.3, 0, 0, 0.5, 0.7, 0.2)$$

$$= B.$$

$$B \circ M_4^T = (0.7, 0, 0, 0, 0.2, 0.7, 0.3, 0.6, 0.5, 0.7, 0.6, 0, 0.7, 0.6, 0, 0, 0.5, 0)$$

$$= C.$$

Now we analyse the resultant C. Clearly the nodes (2), (3), (4), (12), (15), (16) and (18) have taken only the value zero, i.e., the labourers are unconcerned over (2) cut down in the use of chemicals to reduce atmospheric pollution, (3) making alternate arrangements for fuel (4) the pollution of Noyyal river by these industries is unpardonable so those industries which has no RO units can be closed down.

(12) the solid waste from these industries can be used instead of fire wood. (15) it is a pity if the government permits the rich industrialists to buy the near by land for storing the waste water the local, the migrants of Tirupur will be victims of unpredictable diseases.

(16) A team of doctors must be appointed to study the health problems of the locals due to pollution and (18) Government can give them electricity only for alternate day that too only for five hours to cut down pollution. It is really surprising to see the way the labourers are frightened to accept the real situation. The highest value is only 0.7 that too taken by the nodes (1), (6), (10) and (13) i.e. (1) they are of course concerned of deforestation, (6) they fearlessly construe that secret support to the industrialists is given by the government (10) it is unjustifiable that 90 million litres of waste water is let in the environment and (13) it is the right of every citizen to get unpolluted water and air. However the NGO's socio scientists and the environmentalists did not say that government was promoting the wrong acts of the industrialists for money.

Now we proceed on to give the views of the locals of Tirupur. These experts are not labourers or migrant labourers of Tirupur industry most of them are farmers or petty shop owners



or some other public. They are the natives or people who have settled in Tirupur. Overall reaction was given these 53 experts were they were vexed with the industry functioning in such an exorbitant way spending every day 60, 000 kg of chemical polluting the atmosphere. Further they added every day approximately 90 million liters of waste water is let out in the environment which has made the ground water unfit to use for anything.

Their individual opinion was taken and the mean of their opinion related to each concept is given by the FAM model. The matrix  $M_5$  gives the system associated with the FAM.

	$C_1$	$C_2$	$C_3$	$C_4$	$C_5$	$C_6$	$C_7$	$C_8$
1	0.8	0.7	0.7	0.8	0.8	0.8	0	0.8
2	0.8	0.8	0	0.8	0.7	0.8	0	0.7
3	0.7	0	0	0	0	0	0	0
4	0.8	0.7	0.8	0.7	0.7	0.8	0.6	0.8
5	0.8	0.8	0.8	0.6	0.8	0.8	0.7	0.8
6	0.7	0.6	0.5	0.2	0.7	0.6	0.5	0.7
7	0.8	0.7	0.6	0.7	0.8	0.7	0.2	0.8
8	0.8	0.8	0.8	0.9	0.7	0.6	0.3	0.8
9	0.4	0.7	0.9	0.6	0.6	0.9	0.8	0.7
10	0.8	0.9	0.7	0.7	0.8	0.8	0.6	0.8
11	0.8	0.8	0.9	0.8	0.9	0.7	0.8	0.9
12	0.9	0.7	0.2	0.3	0.4	0.2	0.3	0.7
13	0.8	0.8	0.7	0.6	0.8	0.5	0.9	0.8
14	0.2	0.3	0.4	0.2	0.3	0.2	0.7	0.6
15	0.8	0.7	0.7	0.8	0.7	0.8	0.8	0.8
16	0	0	0.2	0.3	0.4	0.5	0.7	0.6
17	0.5	0.6	0.5	0.4	0.6	0.4	0.8	0.8
18	0.7	0.5	0.6	0.7	0.5	0.7	0.7	0.9

However when we compare the views of the labourers working in the dyeing and bleaching industries with the views of the locals of Tirupur who are not employed in these industries we find that the former have given many zeros where as the later have given very many high degree of membership.

$$X = (1\ 0\ 0\ 0\ 1\ 0\ 0\ 0\ 0\ 0\ 0\ 0\ 0\ 0\ 0\ 0\ 0\ 1)$$

be the fit vector.

$$\begin{aligned} X \circ M_5 &= (0.8, 0.8, 0.8, 0.8, 0.8, 0.8, 0.7, 0.8) \\ &= C. \end{aligned}$$

$$\begin{aligned} C \circ M_5^T &= (0.8, 0.8, 0.7, 0.8, 0.8, 0.7, 0.8, 0.8, 0.8, 0.8, \\ &0.8, 0.8, 0.8, 0.7, 0.8, 0.7, 0.8, 0.8) \\ &= Y. \end{aligned}$$

Now we see that atmost all the nodes in C and Y take the maximum value 0.8. The next higher value 0.7 is take by one node in C and four nodes in Y. Thus we see the locals are very much vexed with the functioning of the industries. They feel the ill effect of it as locals. Their frustration and inability is clearly brought out for they are the most affected lot due to these industries.

Next we try to work with the fit vector  $A = (0\ 0\ 0\ 0\ 0\ 0\ 0\ 1)$

$$\begin{aligned} A \circ M_5^T &= (0.8, 0.7, 0, 0.8, 0.8, 0.7, 0.8, 0.8, 0.7, 0.8, 0.9, \\ &0.7, 0.8, 0.6, 0.8, 0.6, 0.8, 0.9) \\ &= X. \end{aligned}$$

$$\begin{aligned} X \circ M_5 &= (0.8, 0.8, 0.8, 0.8, 0.8, 0.8, 0.8, 0.9) \\ &= B. \end{aligned}$$

Clearly the highest value 0.9 is taken by the node  $C_8$  in B and (11) and (18) in X i.e. The want close down the units if they think effluent treatment of the plant is a burden and they are very keen on government supplying them electricity only on alternate days that too only for 5 hours a day. They strongly feel the pollution is due to these plants not having proper RO units.

It is once again interesting to see the next higher value 0.8 is taken by all the nodes in B. Thus one can easily view from these resultant vectors all the nodes  $C_1, \dots, C_8$  happen to have a significant impact on the locals of Tirupur.

Even in the resultant X we see only the node (3) takes zero and the minimum value is only 0.6 taken by the nodes (14) and (16). The next higher value 0.8 is taken by the node (1), (4), (5), (7), (8), (10), (13), (15) and (17). 0.7 is taken by the four nodes (2) (6) (9) and (12).

Consider the fit vector

$$A = (0\ 0\ 0\ 0\ 0\ 0\ 0\ 1\ 1\ 1\ 0\ 0\ 0\ 0\ 0\ 0\ 0\ 0).$$

$$A \circ M_5 = (0.8, 0.9, 0.9, 0.8, 0.9, 0.9, 0.8, 0.9) \\ = B.$$

The maximum value 0.9 is taken by the nodes  $C_2, C_3, C_5, C_6$  and  $C_8$ . This clearly shows majority of the locals very strongly feel, agriculture failure and scarcity of drinking water is due to pollution by these dyeing and bleaching industries of Tirupur, over population in slums due to the concentration of migrant labourers working in these industries.

Due to pollution high presence of substances like chorine, chloride, calcium etc. in the river and ground water which has made it unfit for drinking and agriculture.

Locals will develop health hazards due to the presence of these chemicals and finally all these problems are due to failure on the part of the industries to install proper waste water purification centres.

The next higher value in the resultant B is 0.8 obtained by the rest of the coordinates  $C_1, C_4$  and  $C_7$ . i.e. they are equally concerned about deforestation they are worried about the pollution of the Noyyal river due to the use of 60000 kg of chemicals every day. They are also very unhappy to see the labourers receiving only 20 liters of water per week that water also impure and unfit for drinking.

Now we study the effect of B on the system  $M_5^T$ .

$$\begin{aligned}
B \circ M_5^T &= (0.8, 0.8, 0.7, 0.8, 0.8, 0.7, 0.8, 0.8, 0.9, 0.9, \\
&0.9, 0.8, 0.8, 0.7, 0.8, 0.7, 0.8, 0.9) \\
&= Y.
\end{aligned}$$

The highest value 0.9 in Y is taken by the nodes (9), (10), (11) and (18) followed by next higher value 0.8 taken by the nodes (1), (2), (4), (5), (7), (8), (12), (13), (15) and (17). The least value in Y itself is 0.7 taken by the nodes (3), (6), (14) and (16). The very fact the least value is 0.7 shows that all nodes are very important and the locals are really depressed over the fact that the ground water have become polluted over 300 ft and the pollution of the atmosphere is immeasurable we see of the five groups the locals of Tirupur happen to be maximum affected which is clearly seen from the high values in the resultant.

Finally we analyse the feelings of the trade unions leaders numbering in 9. These trade union leaders are not allowed to inter act with the labourers of these industries. Some of them are even prohibited from entering the industrial complex. The trade union leaders are prevented by court of law in holding gate meetings near to the campus with in a radius of 300 meters.

They are also prevented or prohibited by court of law to raise slogans demands demonstrations and hanging banner with in the distance of 100 meters from the head office. Throughout the discussions the trade union leaders clearly accepted their inability to environmental prevent pollution or help the labourers of their rights for they (the industrialists) got the support of court and the politicians.

The stallion Garments a reputed garment export company is an evidence. Some of the workers who work in this company are not even provided with an appointment order or a salary slip.

The trade union leaders were very interactive when they gave their opinion. Most of them raised the issue that in developing countries like India the pollution of atmosphere and environment especially the ground water is unpardonable. They gave their views however they wished to remain anonymous so we have not mentioned the names of the trade unions. Let  $M_6$  be the associated matrix of the FAM model.

	C <sub>1</sub>	C <sub>2</sub>	C <sub>3</sub>	C <sub>4</sub>	C <sub>5</sub>	C <sub>6</sub>	C <sub>7</sub>	C <sub>8</sub>
1	0.8	0.9	0.7	0.8	0.8	0.7	0.3	0.8
2	0.6	0.7	0.3	0.7	0.7	0.6	0.4	0.7
3	0.8	0.6	0.2	0.6	0.3	0.5	0.3	0.7
4	0.1	0.7	0	0.9	0.8	0.6	0.4	0.7
5	0.8	0.8	0	0.8	0.9	0.8	0.6	0.8
6	0.3	0.7	0	0.7	0.7	0.6	0.5	0.7
7	0.8	0.8	0.1	0.6	0.8	0.7	0.6	0.7
8	0.7	0.7	0.2	0.5	0.6	0.6	0.5	0.8
9	0	0.3	0.9	0.4	0.5	0.8	0.7	0.6
10	0.6	0.8	0.3	0.8	0.9	0.8	0.7	0.8
11	0.8	0.8	0.3	0.7	0.8	0.6	0.5	0.8
12	0.9	0.6	0	0.4	0.7	0.6	0.3	0.6
13	0	0.7	0.5	0.8	0.6	0.5	0.9	0.7
14	0.6	0.6	0.2	0.6	0.5	0.7	0.3	0.8
15	0.1	0.5	0.8	0.4	0.6	0.8	0.7	0.6
16	0.8	0	0	0.3	0.4	0.7	0.5	0.7
17	0.4	0.5	0.1	0.5	0.6	0.5	0.6	0.7
18	0.7	0.8	0	0.6	0.5	0.6	0.3	0.8

Let

$$X = (1\ 0\ 0\ 0\ 1\ 0\ 0\ 0\ 0\ 0\ 0\ 0\ 0\ 0\ 0\ 0\ 0\ 0\ 1)$$

$$X \circ M_6 = (0.8, 0.9, 0.7, 0.8, 0.9, 0.8, 0.6, 0.8)$$

$$= Y.$$

$$Y \circ M_6^T = (0.9, 0.7, 0.8, 0.8, 0.9, 0.7, 0.8, 0.8, 0.8, 0.9, \\ 0.8, 0.8, 0.8, 0.8, 0.8, 0.8, 0.7, 0.8)$$

$$= B.$$

In the resultant Y we see the maximum value 0.9 is taken by the nodes C<sub>2</sub> and C<sub>5</sub> followed by 0.8 taken by the nodes C<sub>1</sub>, C<sub>4</sub>, C<sub>6</sub> and C<sub>8</sub>.

However the least value is only 0.6 well above 0.5.

Suppose we consider the fit vector

$$A = (0 \ 0 \ 0 \ 0 \ 0 \ 0 \ 0 \ 1)$$

to find its resultant on M<sub>6</sub><sup>T</sup>.

$$\begin{aligned} A \circ M_6^T &= (0.8, 0.7, 0.7, 0.7, 0.8, 0.7, 0.7, 0.8, 0.6, 0.8, \\ & \quad 0.8, 0.6, 0.7, 0.8, 0.6, 0.7, 0.7, 0.8) \\ &= Y \end{aligned}$$

$$\begin{aligned} Y \circ M_6 &= (0.8, 0.8, 0.7, 0.8, 0.8, 0.8, 0.7, 0.8) \\ &= B. \end{aligned}$$

We see the maximum value in B is 0.8 obtained by C<sub>1</sub>, C<sub>2</sub>, C<sub>4</sub>, C<sub>5</sub>, C<sub>6</sub> and C<sub>8</sub>. The next value 0.7 is taken by C<sub>3</sub> and C<sub>7</sub>. Thus like the locals of Tirupur the trade union leaders also express the hazarderous effects of pollution by the dyeing and bleaching industries.

In the resultant Y also the maximum value 0.8 is taken by the nodes (1), (5), (8), (10), (11), (14) and (18). The next higher value 0.7 is taken by the nodes (2), (3), (4), (6), (7), (13), (16) and (17). 0.6 is the minimum value taken by the nodes (9), (12) and (15).

Now compare the resultant of the fit vector

$$X = (1 \ 0 \ 0 \ 0 \ 1 \ 0 \ 0 \ 0 \ 0 \ 0 \ 0 \ 0 \ 0 \ 0 \ 0 \ 0 \ 0 \ 1)$$

of the 6 sets of experts.

I set of experts;

$$Y = (0, 0.6, 0, 0.6, 0.8, 0.7, 0.6, 0.8)$$

II set of experts;

$$Y = (0, 0.8, 0.7, 0.8, 0.7, 0.7, 0.6, 0.7)$$

III set of experts;

$$Y = (0.8, 0.8, 0.7, 0.7, 0.8, 0.8, 0.5, 0.8).$$

IV set of experts;

$$Y = (0, 0, 0.6, 0.1, 0.2, 0.4, 0.8, 0.1)$$

V set of experts;

$$Y = (0.8, 0.8, 0.8, 0.8, 0.8, 0.8, 0.7, 0.8)$$

VI set of experts;

$$Y = (0.8, 0.9, 0.7, 0.8, 0.9, 0.8, 0.6, 0.8).$$

When we compare the resultants we see the resultant given by the fourth set of experts who are the labourers (workers working in the Tirupur industries) is distinct from others. They are most bothered about the 20 liters of polluted water they get apart from that nothing bothers them for they feel that closure of these industries will leave them jobless and they have starve till they get employment else where. Thus these people are frightened and very much insecure of the jobs so they suffer in this manner.

The NGO's and socio scientists do not bother about deforestation. It is surprising they are not even bothered about pollution of the ground water. Apart from this the views of the experts work in a similar way.

Now the set of resultants for the same fit vectors

$$X = (1\ 0\ 0\ 0\ 1\ 0\ 0\ 0\ 0\ 0\ 0\ 0\ 0\ 0\ 0\ 0\ 0\ 0\ 1)$$

is given below.

I set of experts

$$(0.8, 0.7, 0, 0.6, 0.8, 0.2, 0.8, 0.7, 0.7, 0.8, 0.4, 0.1, 0.8, 0.6, 0.7, 0.7, 0.8, 0.6)$$

II set of experts

$$(0.8, 0.7, 0, 0.8, 0.7, 0.5, 0.8, 0.8, 0.7, 0.8, 0.7, 0.5, 0.8, 0.7, 0.7, 0.8, 0.7, 0.6)$$

III set of experts

(0.8, 0.7, 0.7, 0.6, 0.8, 0, 0.7, 0.8, 0.7,  
0.8, 0.8, 0.8, 0.8, 0.6, 0.8, 0.7, 0.8, 0.7)

IV set of experts

(0.8, 0, 0, 0, 0.2, 0.7, 0.3, 0.6, 0.5,  
0.7, 0.6, 0, 0.8, 0.6, 0, 0, 0.5, 0)

V set of experts

(0.8, 0.8, 0.7, 0.8, 0.8, 0.7, 0.8, 0.8, 0.8,  
0.8, 0.8, 0.8, 0.8, 0.7, 0.8, 0.7, 0.8, 0.8)

VI set of experts

(0.9, 0.7, 0.8, 0.8, 0.9, 0.7, 0.8, 0.8, 0.8,  
0.9, 0.8, 0.8, 0.8, 0.8, 0.8, 0.8, 0.7, 0.8).

When we compare the six resultants we see only the resultants vector given by the IV set of vectors viz. the labourers of industries in Tirupur give a view different from all the others. This is mainly due to their employment and insecurity added with poverty and penury.

The set of NGO's experts environmental alone felt that politicians are only after money. Others experts feel that government and politicians are involved in the deed as the node (6) takes value 0.7. Further the NGO's and the labourers of the Tirupur industries feel the node (12) is irrelevant in their study i.e., the municipal solid waste can be used as garbage to reduce deforestation.

The trade union leaders wish to work with the on state of the coordinate 18 alone i.e., they want government to supply them electricity only on alternative days that too only five hours i.e., we work with the fit vector

$$X = (0\ 0\ 0\ 0\ 0\ 0\ 0\ 0\ 0\ 0\ 0\ 0\ 0\ 0\ 0\ 0\ 0\ 0\ 1).$$

$$\begin{aligned} X \circ M_6 &= (0.7, 0.8, 0, 0.6, 0.5, 0.6, 0.3, 0.8) \\ &= Y. \end{aligned}$$



$$\begin{aligned}
Y \circ M_6^T &= (0.8, 0.7, 0.7, 0.7, 0.8, 0.7, 0.8, 0.8, 0.6, 0.8, \\
& \quad 0.8, 0.7, 0.7, 0.8, 0.6, 0.7, 0.7, 0.8) \\
&= Z.
\end{aligned}$$

The maximum value of the resultant vector Y is 0.8 taken by the nodes C<sub>2</sub> and C<sub>8</sub>, the failure of agriculture due to pollution of ground water and the fact that these industries do not have proper RO units to purify the waste water C<sub>3</sub> takes the value 0 i.e., water has become scarce due to over population most of whom are migrant labourers. Also the node C<sub>7</sub> i.e., the company employees get only 20 liters of drinking water per week take only the least non zero value viz. 0.3.

When we analyze the resultant vector Z the maximum value 0.8 is taken by the nodes (1), (5), (7), (8), (10), (11), (14) and (18). i.e., when the node supply of electricity for only 5 hours on alternative days is in the on state we see

(1) closure of all these plants if RO unit is not properly implemented. (5) these industries which make money in crores is least bothered about the locals or farmers or environment. (7) the production of agriculture was high before the building of the dam and water pollution, (8) Foreign countries enjoy the product at the cost of environmental pollution. (10) the unaccountability of 90 million liters of waste water per day let out in the environment do not bother about its effect on locals and farmers. (11) – The claim of the industrialists that they buy water annually water for 7 million dollars, so the very idea of building RO units is not feasible. (14) – The owners of these industries must pay damages to the farmers take the maximum value. All nodes in Z take very high values varying from 0.6, 0.8. Only two nodes (9) and (15) take the least value viz. 0.6 i.e., (9) due to migration the locals have the chance of getting dreaded diseases like HIV/AIDs, Malaria, TB etc. (15) It is a pity the government permits the industrialists to buy the near by land to let the water takes the least value.

Fit vectors with different nodes in the on state was used an resultant was obtained. The conclusions are based on the resultant of these fit vectors.

## Observations

Migrant labourers happen to be the dominant category of labourers leading to several problems like

1. Debt i.e., they live in perennial debt and migration has increased the households that are in debts [50].
2. Due to migration increase in deadly diseases like AIDS, viral hepatitis, TB bronchitis, gastroenteritis and other skin and eye related disorders.
3. Workers union cannot enter to fight for workers regarding medical facility or any other issue. They are bared of entering even the near by premises.
4. Tirupur happens to give the highest percentage of house holds below poverty.
5. As majority of the migrant labourers live in slums they do not have proper means of disposing the garbage or have any proper drainage system / sewerage system leading to health hazards like viral fever, dysentery, malaria, eye infection, skin diseases, and others.
6. These migrant workers live in unelectrified households.
7. During monsoon the sewerage flows into the huts of the households and their living conditions are poorest and they suffer serious diseases because they are transmitted through air, water, soil and food (or through insect or animal).
8. Being poor and to economize on fuel almost all households do not boil the drinking water. Dysentery a water borne disease is very common slum dwellers;

most of whom are migrant labourers. Malaria is found among 30% of the migrant households in slums.

9. The incidence of poverty in terms of households is larger in Tirupur slum (migrants) [50]. Table given below.

**Percentage of sample migrant households below poverty line**

<b>Sl.No</b>	<b>Area</b>	<b>Income Criteria</b>	<b>Per capita monthly consumption expenditure criteria</b>
1	Coimbatore slums	40%	33%
2.	Tirupur slums	51%	40%
3.	Chennai slums	44%	35%

10. Nearly 63% of the children of the migrant households in the age group 6 to 14 are working. 22% studying, 15% are neither studying nor working. Combining the data for Tirupur Coimbatore and Chennai it is observed that the incidence of child labour is more pronounced among boys (67%) than girls (56%).
11. These plants / industries must make use of biotechnology in the treatment of waste water which is approximately 90 million liters a day if this water is again fully purified one can reuse it so that the industries need not spend freshly so many millions of liters of water per day. The water can be purified and reused, thus one can go on using it without burdening the nation; in which case the amount of water used for each day will be drastically reduced!

12. Solar energy can be used so that deforestation can be reduced. Also the solid waste should be used for fuel so that forests can be saved. Strong ban on cutting trees for fuel should be put. Unless this is done the nation will certainly face ecological instability which can never be compensated.
13. Noyyal river should not become like the Palar river which was polluted by the leather industries. It is high time the government involves and closes down these erring units.
14. The locals feel the danger they face in terms is disease and genetic disorder is in no proportion to the monetary benefit the nation gets by supplying products to the western countries.
15. The government should not bother about the six thousand crores of foreign exchange for it has cost the pollution of Noyyal river, ground water has become poisonous and all agricultural lands have become deserts. The experts suggested that government should adopt modern industrial biotechnology and built proper reverse osmosis units failing which the only solution being the closure of these plants. However the Russians using modern technology would install a waste water purifying unit at a cost of Rs. 323 crores.

They would use the electro dynamic hydro wave technology which is the cheapest method and it costs only 3 paise for one liter and the purified water can be even used for drinking.

Further they said there is no danger to the environment being polluted by chemicals. It is a pity still a complete control of the situation has not taken place. Even if they do not wish to involve any nation they can send some expert team get a coaching from them for the same and implement it.

16. Most of the experts say that at this stage these types of industries and agriculture cannot coexist, nothing happens to the industries but ultimately the land and water become poisonous.

In due course of time it would be impossible for human to live in the neighbourhoods of these industries.

17. If the owners of these industries had studied properly the amount of waste water and solid waste that would be emitted by these industries and proper care would have been taken for their purification and management those would not have affected the ground water river water and the land in that case certainly the nation would not face such an irreparable loss and damage to the environments.

Further the experts said that these industries in greed for money has immensely increased the product which has automatically increased the waste water and solid waste and with no proper RO unit have polluted the Noyyal river and the ground water over 300 ft. Only in due course of time we are going to see the health hazards and genetic disorders of the locals and labourers of these industries which will be reflected by the future generation. The experts could by no means reconcile to the pollution caused by these industries.

If at all the government had a expert system which gave more importance to waste management of the industries even before the functioning of these industries certainly the environment could have been saved said the experts.

They hope now atleast the government would have become aware of these problems and take these precautions before sanctioning the functioning of any new industries be it chemical industries or otherwise.

Considering the water scarcity it is advisable not to sanction any new industries which consume lot of water, until the bio technological methods for the

purification of waste water is achieved with self sufficiency.

18. India to vie with the developing countries must develop technologist and engineers in biotechnology used in industries. Unless such developments are made it is impossible to control environmental pollution.
19. Political leaders should first understand the gravity of the situation that environmental pollution made can directly to the genetic disorder and the health hazards which cannot find any cure using the present day medicines. Unless stern steps are taken to stop environmental pollution the future of India is bleak.

It is still unfortunate to state that economically poor will be the maximum affected so it is very important as majority of the nations populations are poor the government should curb the environmental pollution. However the authors feel that the study of the social problems do not come under the method of biotechnology for industrialists. As most of the experts have mentioned this, we have been forced to include it in the suggestions.

20. Many environmentalists were very much upset over the High Court of madras orders given on the 2<sup>nd</sup> of Sept. which states that before December these units should set up RO units after which the release of effluents into Noyyal river should stop.

Already due to the release of effluents into the Noyyal river 120 tonnes of fish that had died. If the nation suffers a set back on foreign exchange or even if the nation runs at a loss the HC should order only for the closure of the textile mills; till the RO units are set up. Imagine in 3 months what amount of damage the effluents would have done to the Noyyal river!

The same has occurred in the Erode where the fish caught in the Orathupalayam river are poisonous and

those who consume it have the danger of getting health problem.

The water in this dam has become poisonous due to the mixing up of the effluent water from these Tirupur dying industries in the Noyyal river. The agriculturists are suffering for they cannot do farming. From the research carried out on the fish in the Orathupalayam dam these fish contain black lead, cadmium and chromium to a very great extent.

In the year 2003 they have banned fishing in these areas, however they fishing disobeying the ban and sell these fish at the rate of Rs. 5 per kg. These fish are purchased by Hostel owners and Hawkers. We just give the land use in the local planning area 1984 and the proposed land use 2001.

#### **Land use in Local planning area – 1984**

<b>Use</b>	<b>Area in km</b>
Residential	19.97
Commercial	1.67
Industrial	4.23
Educational	1.30
Public and semi pub.	0.68
Agricultural	190.41
Total	218.28

### Proposed land use – 2001

Use	Area in km
Residential	66.72
Commercial	4.18
Industrial	18.37
Educational	6.31
Public and semi pub.	1.48
Agricultural	121.19
Total	218.28

As the land use cannot be included in the biotechnology for industries yet the experts felt it essential for any reader to understand the problems of environmental pollution.

They said now the land use by industrial area is more than 18.37. Further the land use by agriculture has so badly dwindled due to the pollution of ground water and the Noyyal river, the agricultural land has become unfit for agriculture claims the locals and environmentalists.

Further it is a pity a agricultural nation like India all areas from 1984 to 2001 get increased only the agricultural land is nearly decreased by 70 square kms, which clearly shows the conversion of agricultural land for industrial use. Locals said the number of knitting mills in Tirupur in 50 years 1941 – 1991 has increased from 22 to 2, 800.



20. Finally the Resource Flow Analyze or RFA for the textile industries in Tirupur units given in the figure 2.1 in page 49 is taken from (*Industrial ecology – A new platform for planning Sustainable Societies*, Ramesh Ramasamy, Environmental Policy Research Centre Berlin). The case study carried out by Ramesh [39] clearly shows the grave situation of how the water from these industries have polluted the underground water and Noyyal river water beyond redemption.

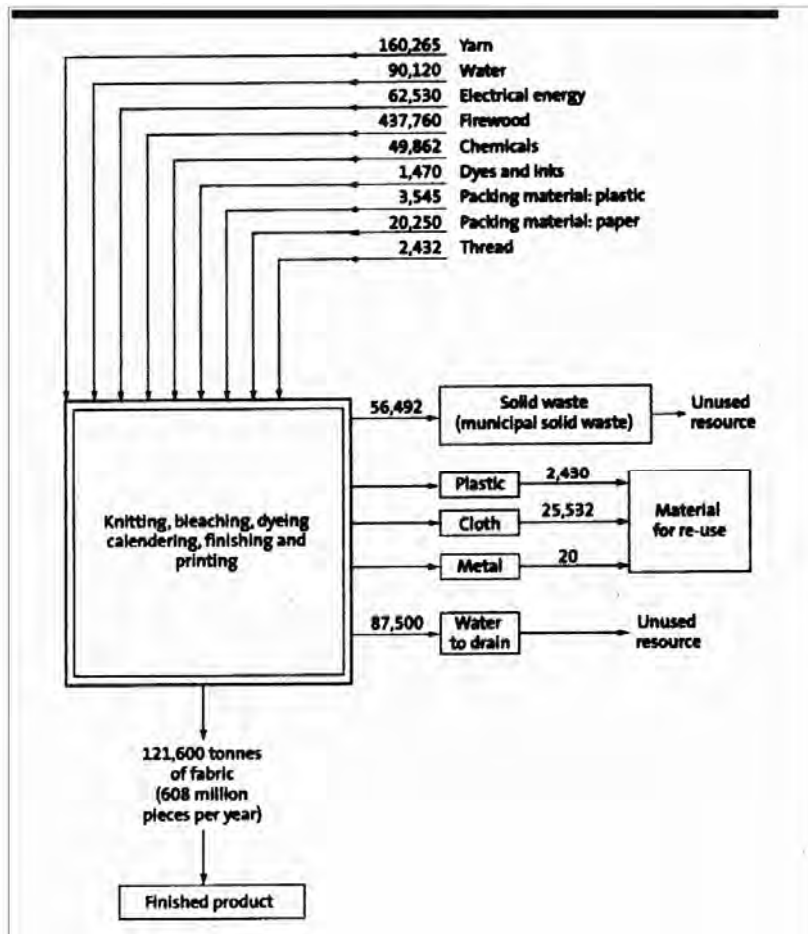
The case study carried out by Ramesh [39] has also given the following facts which shows why the government is slow in taking action over the pollution of underground water resources and Noyyal river by the garment industries in Tirupur.

*“Tirupur is a major center for the production of knitted cotton hosiery. The town is located in the south of India and has a population of about 300,000. The 4,000 small units in the town specialize in different aspects of the manufacturing process.*

*The aggregate annual value of production in the town is around US \$ 825 million. Much of the produce is exported bringing in very valuable foreign exchange.*

*Till about the 1980s, for decades, the center was only manufacturing white undershirts called “banians”, which are commonly worn by men in India. The industry then discovered the lucrative international market for colored T-shirts, which led to a boom in exports.*

*This enormous growth in the production of colored textiles, led to an increase in the dyeing operations in the town.”*



**Figure 2.1**

From the figure it is very clear that every day waste water is let out in the environment. Till date we do not know what type of chemicals are present in it. Neither do we know the amount of dyes and inks present in it.

Further no body knows how the resultant combination of chemicals act on plants, human and above all the environment. However if the waste water

is made as water for reuse certainly it would be a great boon in many ways.

21. The environmentalist however did not accept the amount of firewood used by these industries, they demanded only alternative fuel. Deforestation in the present context is very dangerous taking into account the problem of global warming.

## Chapter Three

# HIERARCHICAL GENETIC FUZZY CONTROL ALGORITHM TO IMPROVE THE SYSTEM PERFORMANCE AND REDUCE POLLUTION BY CHEMICAL PLANTS

### 3.1 Introduction

In this chapter we approach the problem of determination of the process control variables in chemical plants using a hierarchical genetic fuzzy control algorithm. Here we find a new process control variable, which can be used to improve the system performance and there by reduce the pollution. The analysis of our study is focused on the chemical plants reported by Shimada et al (1995).

The data obtained from the chemical industries is

transformed into a hierarchical genetic fuzzy control algorithm model. After obtaining this model, using the techniques of selection and crossover, a new process control variable is found which improves the system performance.

Finding of the new process control variable of chemical industry plays a vital role in the improvement of the system performance of chemical industry, since the infeasible process control variables are affecting the system performance resulting in material waste, loss of time, engineering cost pollution and damage to the very system of chemical industry.

In 1984 Lees, used decision tables of operability study to chemical plants. This study is a method that examines the safety of chemical plants by systematically identifying every conceivable process deviation.

In 1995 Shimada et al., studied the chemical industry problem with decision tables of operability study. This method is also used to examine the safety of chemical plants by systematically identifying every conceivable process deviations with the use of computer. But their method has given more process control variables to process the system than necessary. So these unnecessary process control variables affect the system performance.

As already mentioned, here we approach the problem of the determination of the process control variables using a hierarchical genetic fuzzy control algorithm. Probably, so far no one has approached this problem in chemical industry via hierarchical genetic fuzzy control algorithm. Here hierarchical genetic fuzzy control algorithm is used in the optimization of the process control variables and to improve the system performance in chemical industry which in turn will help in the control of pollution.

The raw data taken from the past happenings in chemical industry are used in the hierarchical genetic fuzzy control algorithm. Each data is considered as a population string in the hierarchical genetic fuzzy control algorithm. Finding the new process control variable from the past happenings processes control variables is a two-stage process. In the first stage, past happening processes control variables are designed into the hierarchical genetic fuzzy control algorithm. Using a fitness

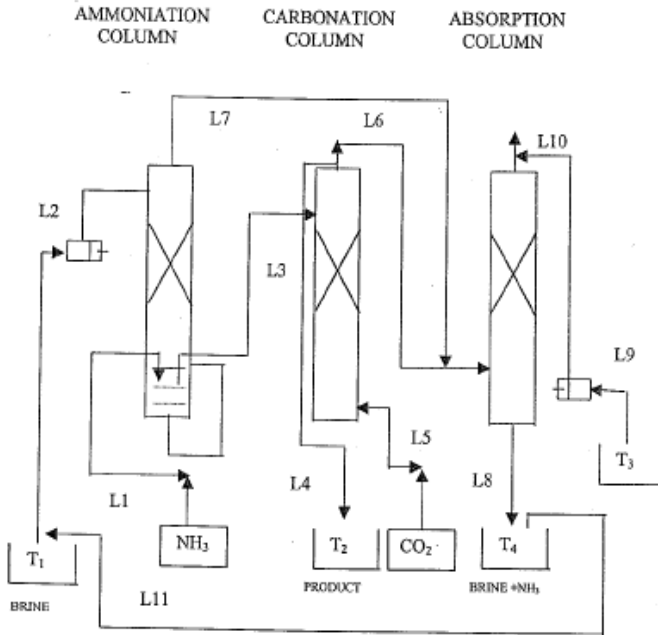
function, fitness value is evaluated to each process control variables selected for survival according to the selection probabilities. The method of crossover is used to obtain new process control variable from the selected process control variables. Here, the new process control variable can be generated through the exchanging of the existing ones. In the second stage, to improve the effect of the new process control variable the DNA formation technique is used; the new process control variable is converted into the DNA formation and the unnecessary rules are identified and removed from the new process control variable.

### **3.2 Description of the Problem**

The problem is the optimization of the process control variable from the past happening process control variables and to find a new process control variable, which will improve the system performance. In this chapter it is established using the data given by Shimada et al. (1995), that a new process control variable with minimum valid conditions can be obtained from the past happening process control variables. Thus, our analysis not only finds the new process control variable to improve the system performance but also lessens the rules in determining the new process control variable. By including unnecessary process control variables and all rules in the process control variables, the chemical industry loses time, incurs the loss of material, pollution and labour, which in turn affects the system performance. Hierarchical genetic fuzzy control algorithm approach not only suggests the new process control variable to minimize the material waste and time loss but also improves the system performance and controls pollution.

A typical flow-chart of a chemical industry is described, which manufactures two or more different chemicals with '11' flow-lines ( $L_1, L_2, \dots, L_{11}$ ) shown in the following figure [Shimada et al.(1995), [43]].

**Figure 3.1: Chemical Plant**



These eleven flow-lines control the process of the chemical plant, that means internally controlled process variables like pressure, evolution etc. and state variables like temperature, concentration etc. But the system of working with flow-lines is very complex for manufacturing different chemicals. Researchers have developed operability study to control the flow-lines for improving the system performance.

Operability study is a method that examines the safety of chemical plants by systematically identifying every conceivable process deviations. Operability study can serve as a useful aid to engineers to design the operation. In recent years, this study has become recognized as an essential part of the process design. It can reduce the time and engineering cost. The tools for the operability study are guidewords, property words and decision tables. The decision tables play an integral part in operability study as the guidewords and the property words are governed by decision tables. The guidewords are applied to

process variables and parameters, such as flow-rates, temperature, etc.

For example, the application of the guideword 'no' to the process variable flow-rate is the deviation 'flow no'. Property words are divided as process variables and state variables. Component information is stored in the form of decision tables. The decision table components are pumps, pipes, valves, and controllers, heating units, cooling units and so on. In this problem ten types of decision tables ( $dt_1, dt_2, \dots, dt_{10}$ ) are developed by the operability study to control the eleven flow-lines so as to improve the performance of the system. The ten types of decision tables describe how the resultant component can be influenced by the internal states of the component in the flow-line (pump, valve, etc.).

Relationships between input states, output states and the internal states of the decision tables are summarized in table 3.1.

**Table 3.1: Type of Decision tables**

<b>Types</b>	<b>Input States</b>	<b>Internal States</b>	<b>Output States</b>
$dt_1$	Variables in line outlet state		Variables in plant
$dt_2$	Variables in line inlet side		Variable in line outlet side
$dt_3$	Variables in peripheral equipment		Variables in plant
$dt_4$		Component states in the line	
$dt_5$		Component states in peripheral equipment	

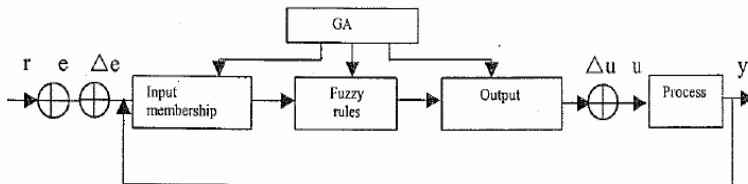


$dt_6$	Variables in line outlet side	Component states in the lines	
$dt_7$	Variables in peripheral equipment	Component states in peripheral equipment	
$dt_8$	Variables in plant		Variables in line inlet side
$dt_9$	Variables in the Line inlet side		Variables in plant
$dt_{10}$	Variables in line outlet side		Variables in line inlet side

### 3.3 Application of Hierarchical Genetic Fuzzy Control Algorithm to Control Process Variables of Decision Tables in Chemical Plants

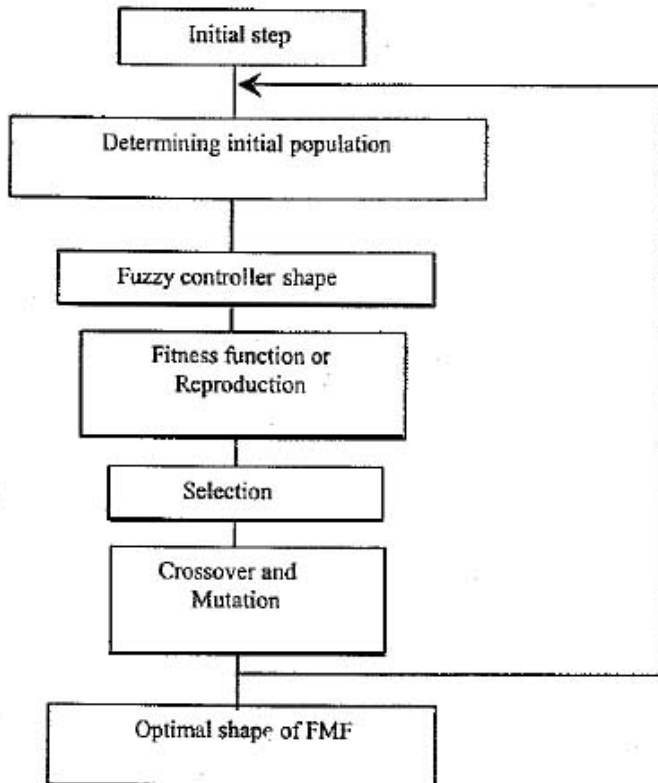
This session proposes the following hierarchical genetic fuzzy control algorithm design to the decision tables of operability study in chemical plants for improving the performance of the system, which is shown in the following figure 3.2.

**Figure 3.2: Hierarchical genetic fuzzy control algorithm designs**



Here  $r$  is the desired process,  $e$  and  $\Delta e$  are inputs and outputs from successive processes,  $\Delta u$  is the output membership grade,  $u$  is an input for future desired process, and  $y$  is an output. Consider the membership function as a membership chromosome (process control variable). To obtain a complete design for the Fuzzy Logic Controller (FLC) an appropriate set of fuzzy rules is required to ensure the system performance. The genetic algorithm is used to optimize the fuzzy controller membership functions and rules; this process is called the hierarchical genetic fuzzy control algorithm. The general scheme of the optimization of the Fuzzy Membership Function (FMF) is given by the following flowchart in figure 3.3.

**Figure 3.3: General Scheme**



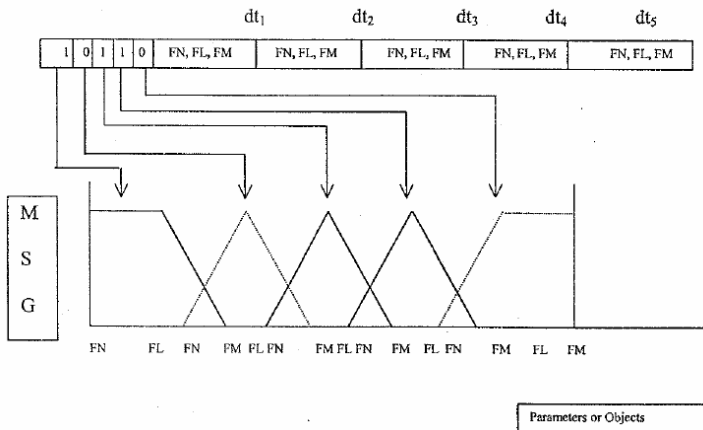
### 3.4 Use of Hierarchical Genetic Fuzzy Control Algorithm in the Real Data

We approach the problem in two stages. In the first stage, Hierarchical Genetic Fuzzy Control Algorithm (HGFC) is applied to the first five decision tables  $dt_1, dt_2, dt_3, dt_4, dt_5$ . In the second stage the deoxyribonucleic acid DNA formation is adopted to optimize the rules obtained in stage 1.

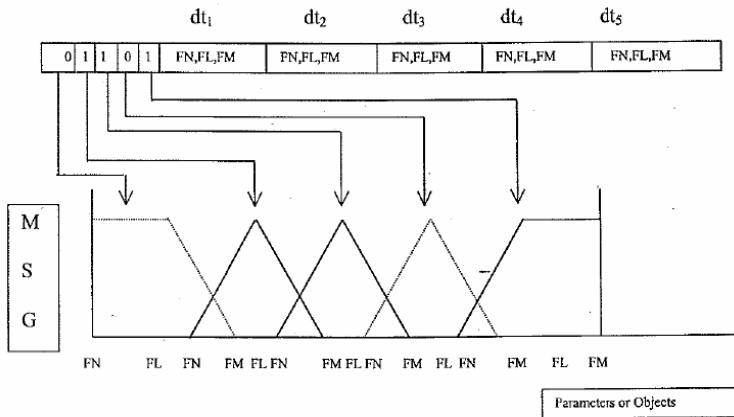
#### Stage 1: Finding new process control variable for the decision tables ( $dt_1, dt_2, dt_3, dt_4, dt_5$ )

The data of Shimada et al. (1995), is taken as the past happening feed back for the problem dealt with in this chapter. The chemical plant with 11 flow lines and 10 decisions tables given by Shimada et al. (1995), is taken for the study. Here HGFC is applied for the first five decision tables  $dt_1, dt_2, dt_3, dt_4, dt_5$  with the control process data (10110), (01101), (01011) and (10011). The four-control processes of five decision tables are called the population strings. Using the hierarchical genetic fuzzy control algorithm to the problem of four population strings, the following hierarchical genetic fuzzy control algorithm, figures 3.4, 3.5, 3.6 and 3.7, are obtained; here the dotted lines in the figure describe the off state and the regular lines describe the on state.

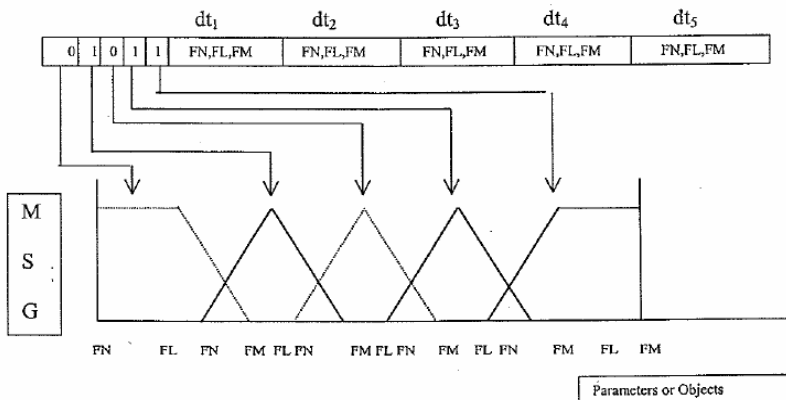
**Figure 3.4: HGFC Design for Population string-1**



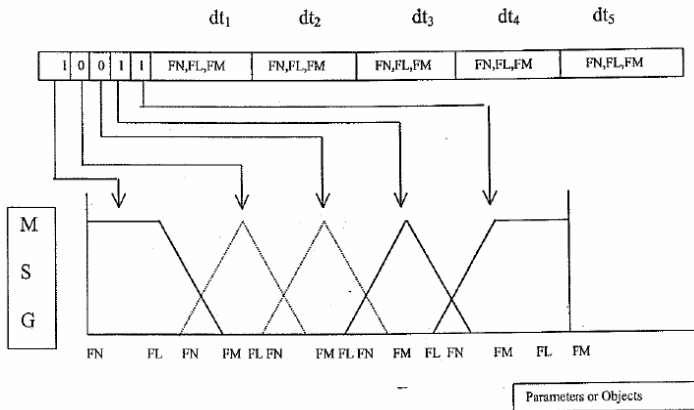
**Figure 3.5: HGFCAs Design for Population string- 2**



**Figure 3.6: HGFCAs Design for Population string-3**



**Figure 3.7: HGFC A Design for Population string-4**



From the figures 3.4, 3.5, 3.6 and 3.7 the HGFC A code parameters of the search space (control process data) as binary strings of fixed length are obtained. These population strings so obtained are used now as the initial strings from the chemical industry. Next selection, crossover and DNA formations are used to find a new process control variable with minimum rules.

The fitness function for population string and selection are described. System performance by genetic operation such as selection or reproduction is a process. Define a fitness function  $f$  as the process of system performance (that is defined on each resultant value of the population string), which is to be maximized for identifying the system performance. By means of using reproduction, this chapter selects the mating pool (process control variables) of the next system process, which is given in the table 3.2.

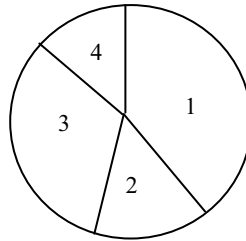
**Table 3.2: Determination of fitness value for initial population strings**

No.	Population Strings (PS)	Fitness Function (FF) defined on (PS)	Percentage of total
1	10110	484	42
2	01101	169	14.89

3	01011	121	10.66
4	10011	361	31.8

The reproduction operator expressed in the form of roulette wheel where each current string in the population has a roulette wheel slot sized in proportion is shown in figure 3.8.

**Figure 3.8: Reproduction allocated using roulette wheel with slots sized according to fitness values**



The mating pool of the next identifying system performance is selected by spinning the weighted roulette wheel four times, as there are only four Initial Populations (IP) which is given in the first column of the Table 3.3. The result is tabulated as follows:

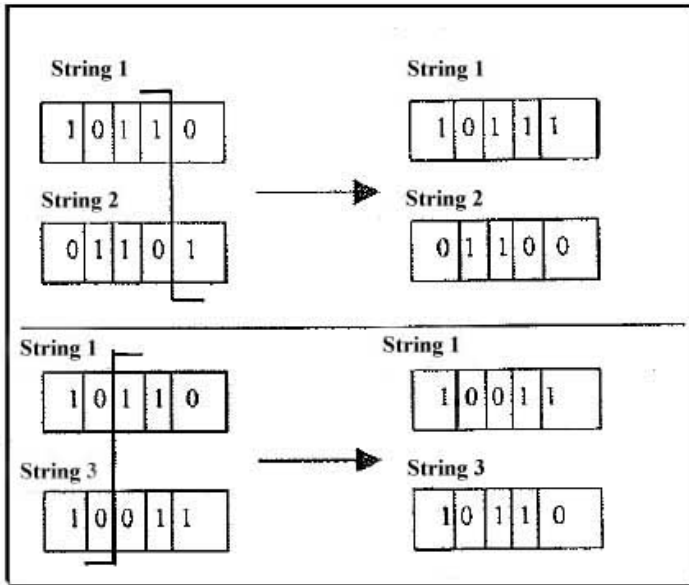
**Table 3.3: Determination of fitness value by roulette wheel**

No	Initial Populations (IP)	FF using IP	Probability	Expected count	Roulette wheel allocation
1	10110	484	0.42	1.7	2
2	01101	169	0.1489	0.596	1
3	01011	121	0.1066	0.42	0
4	10011	361	0.318	1.272	1

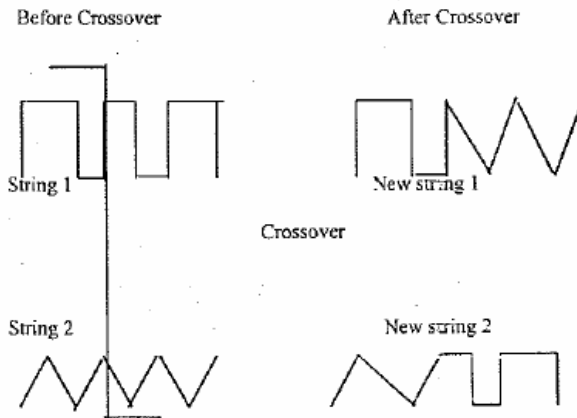
From the last column, we see string 2 and string 4 receive value '1' in the mating pool and string 1 receives value '2'. From the table 3.3, we see the best gets more value; the average stays even and the worst dies off getting the value 0. Now we apply crossover to the three existing strings. The first string in the

mating pool to be mated with second string and first string in the mating pool to be mated with fourth string are shown in figure 3.9 and figure 3.10.

**Figure 3.9: Crossover**



**Figure 3.10: Describes the corresponding diagrammatic representation of figure 3.9**



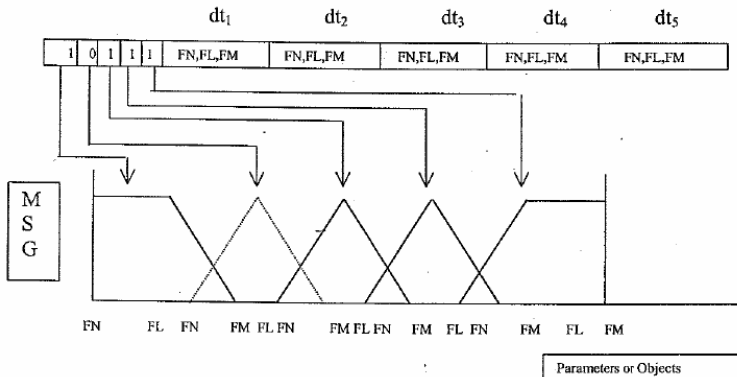
Now the view strings created by the hierarchical genetic fuzzy control algorithm are decoded and their fitness function values which are calculated tabulated in table 3.4.

**Table 3.4: Determination of fitness values for new population strings**

No.	New population (NP)	Fitness function fusing NP
1	10111	529
2	01100	144
3	10011	361
4	10110	484

By the above method the fitness has improved from 484 to 529, the resulting string is 10111 (decision tables for system performance). This value proves to be a very good performance of the system. Thus from this study it is proposed that 10111 population string should be taken for the next process of the system to proceed to the second stage. Now the new membership function of HGFCA (new process design) is given in the following figure 3.11.

**Figure 3.11: New Process Design HGFCA**





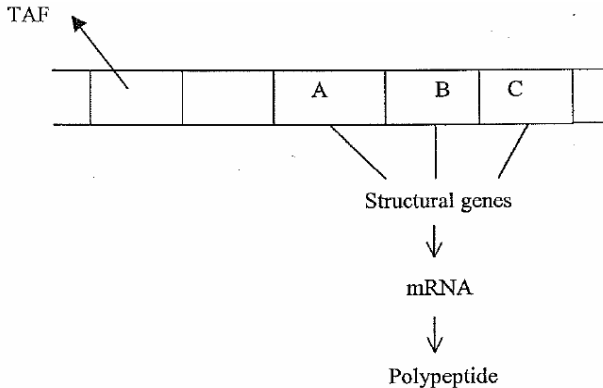
## Stage 2

### Optimization of the Design rules of the New Hierarchical genetic fuzzy control algorithm

This approach differs from the other techniques, in that it has the ability to give minimal rules in new process control variable. This can be done only via the attributes of a genetic algorithm.

To bring out the best use of the genetic algorithm, a reprise of biological genetic algorithm is carried out. This effect aims to emulate the formulation of a deoxyribonucleic acid (DNA) structure in such a way that a precise hierarchical genetic structure is formed for the purpose of optimizing the fuzzy rules.

**Figure 3.12: DNA, transacting factor promoter for the initiation of transcription**



A genetic product, generally known as a polypeptide, is produced by the DNA only when the DNA structure is experiencing biological and chemical processes. From such a genetic process the genes can be classified into the following two different types: 1. Regulatory Sequences (RS's) and 2. Structural Genes (SG's). The RS's serve as the leaders that denote the beginning and ending of SG's. One of the RS's found in the DNA is called the promoter, and it activates or deactivates SG's due to the initialization of transcription. This initialization is governed by the Transacting Factor (TAF)

acting upon this sequence in the DNA. The transcription can take place only if a particular TAF is bound on the promoter. A polypeptide is then produced via a translation process, in which the genetic message is coded in messenger RNA (mRNA). Therefore, a hierarchical structure is obtained within a DNA formation, as depicted in figure 3.12. Active and inactive genes exist in the SG's. During the process, the active genes only, are formed. That means the activation of the parameter genes is governed by the value of the control genes, which is an analogue to the control effect of the TAF on regulatory sequences. An integer '1' is assigned for control gene that is being ignited, and '0' is assigned for turning off. When T is signaled, the associated parametric genes corresponding to that particular active control gene are activated.

Consider a chromosome formed by the five parametric genes, which are taken as the first five decision tables of the problem with five control genes as shown in the figure 3.13.  $x_j$  - control genes = {10111} = { $x_1, x_2, x_3, x_4, x_5$ } is taken as the new population string which is obtained in stage 1.

**Figure 3.13: Population string or control gene = {1 0 1 1 1}**

Control genes					Parametric genes (Decision tables)					
1	0	1	1	1		dt <sub>1</sub>	dt <sub>2</sub>	dt <sub>3</sub>	dt <sub>4</sub>	dt <sub>5</sub>

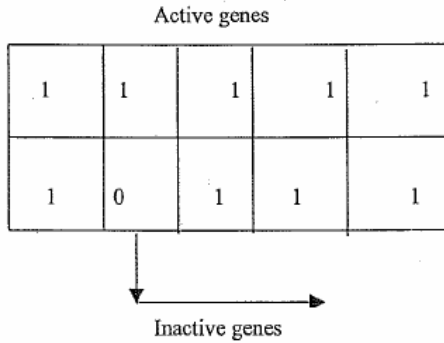
Now we adopt the DNA structure to both control genes and parameter genes to optimize the gene structure:

**Figure 3.13a: New population string with DNA formation**

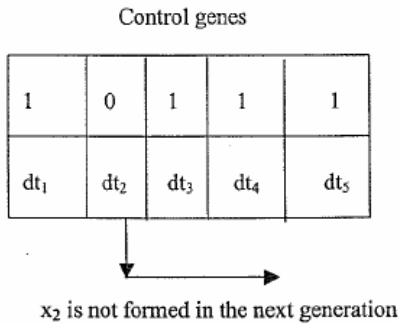
TAF	Control genes					Parametric genes (Decision tables)						
1	0	1	0	1	1	1		dt <sub>1</sub>	dt <sub>2</sub>	dt <sub>3</sub>	dt <sub>4</sub>	dt <sub>5</sub>

Now we can see the possible encoding as follows:

**Figure 3.13b: Possible encoding**

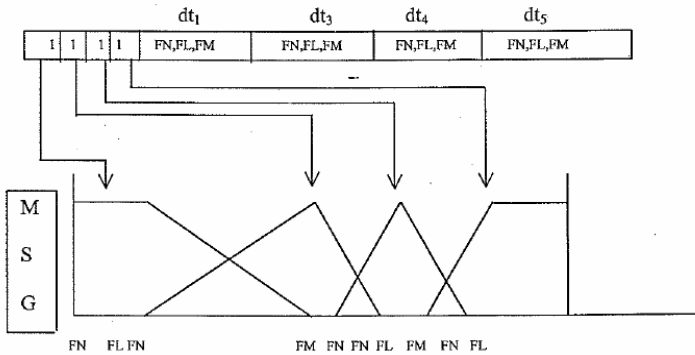


**Figure 3.13c: Possible encoding**



We apply the DNA formation to the new hierarchical genetic fuzzy control algorithm process design given in figure 3.13a to reduce the rules of the new process control variable. By using the optimized membership function of the hierarchical genetic fuzzy control algorithm, the 25 fuzzy rules are used to find best flow types in decision tables for the next process of the system. After applying the DNA formation to the new optimized population string, only 16 fuzzy rules, which are shown in figure 3.14 are obtained. Now fuzzy rules reduce in number from 25 to 16 during the same period, which is illustrated by the following diagram. The decision table dt<sub>2</sub> is not necessary for the next process.

**Figure 3.14: Optimized New process design HGFC A**



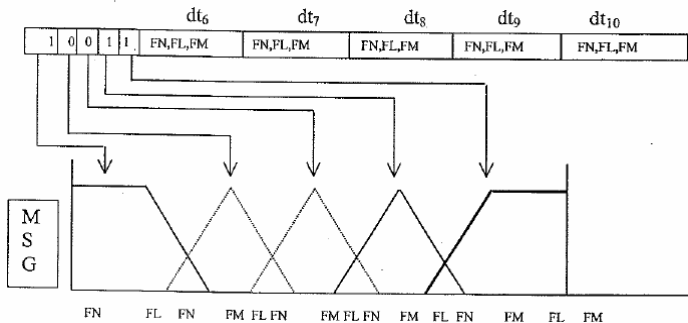
In a similar way using the decision tables  $dt_6$ ,  $dt_7$ ,  $dt_8$ ,  $dt_9$ ,  $dt_{10}$  this chapter finds the new process variable.

**Stage 1**

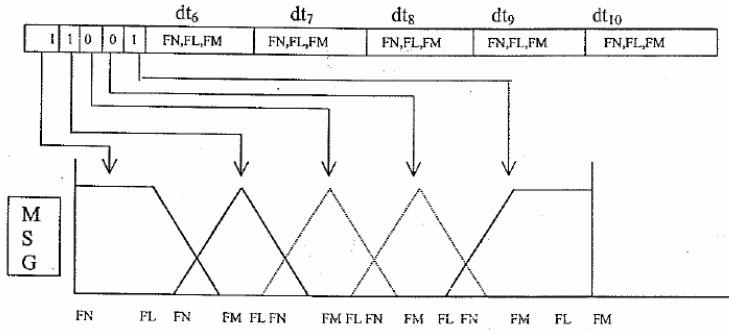
**Finding new process control variable for the decision tables ( $dt_6$ ,  $dt_7$ ,  $dt_8$ ,  $dt_9$ ,  $dt_{10}$ )**

Now HGFC A for the remaining five decision tables  $dt_6$ ,  $dt_7$ ,  $dt_8$ ,  $dt_9$ ,  $dt_{10}$  is applied and the control process data viz (10011), (11001), (01101), and (00111) are obtained from past happening processes in chemical industries [Shimada et al. (1995)] for the next process. As in the earlier case the following diagram describes the four population strings.

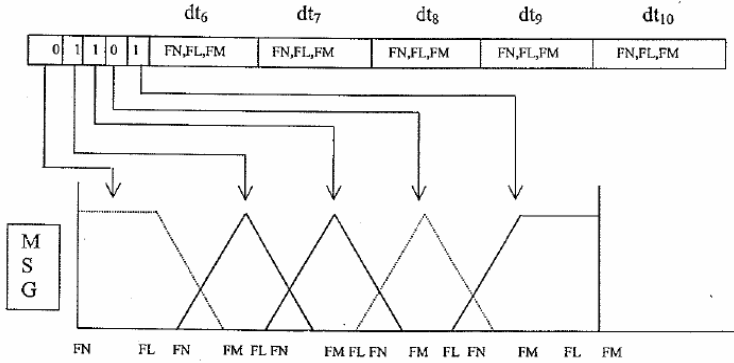
**Figure 3.15: HGFC A Design for Population string-5**



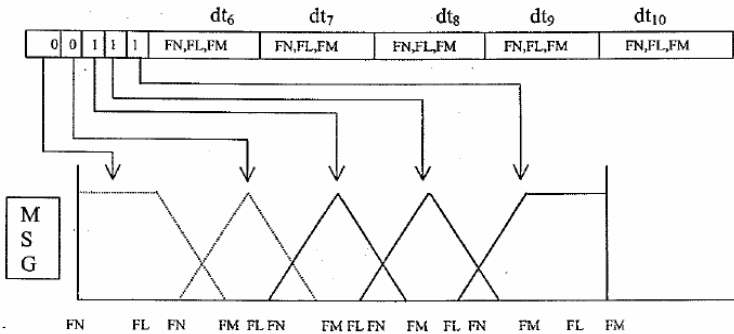
**Figure 3.16: HGFCFA Design for Population string 6**



**Figure 3.17: HGFCFA Design for Population string-7**



**Figure 3.18: HGFCFA Design for Population string-8**



### Fitness function for population string and selection

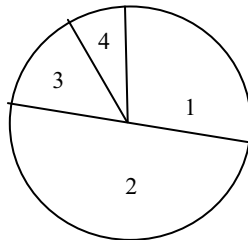
As in the earlier case the following table gives fitness value for population strings 5, 6, 7, and 8 as follows

**Table 3.5: Determination of fitness value for initial population strings**

No.	Population String (PS)	FF f defined on PS	Percentage of total
5	10011	361	30
6	11001	625	52
7	01101	169	14
8	00111	49	4

The reproduction operator expressed by the method of roulette wheel where each current string in the population has a roulette wheel-slot sized in proportion, is shown in figure 3.19.

**Figure 3.19: Reproduction allocated using roulette wheel with slots sized according to fitness values**



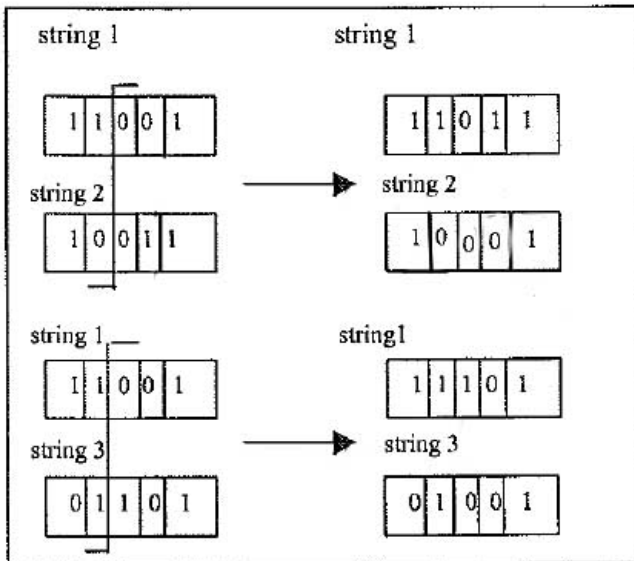
Now the mating pool of the next identifying system performance is selected by spinning the weighted roulette wheel four times, as we are working only with four Initial Population strings (IP) given in the first column of the table 3.6.

**Table 3.6: Determination of fitness value by roulette wheel**

No.	Initial population	FF using IP	Probability	Expected count	Roulette wheel allocation
1	10011	361	.30	1.20	1
2	11001	625	.52	2.08	2
3	01101	169	.14	0.56	1
4	00111	49	.04	0.16	0

From the last column, we see string 1 and string 3 receive value 1 in the mating pool and string 2 receives value 2. From the table 3.6, we see the best gets more value; the average stays even and the worst dies off getting 0. Now we apply crossover to the three existing strings. The second string in the mating pool to be mated with the first string and the second string in the mating pool to be mated with the third string, which are shown in figure 3.20.

**Figure 3.20: Crossover**



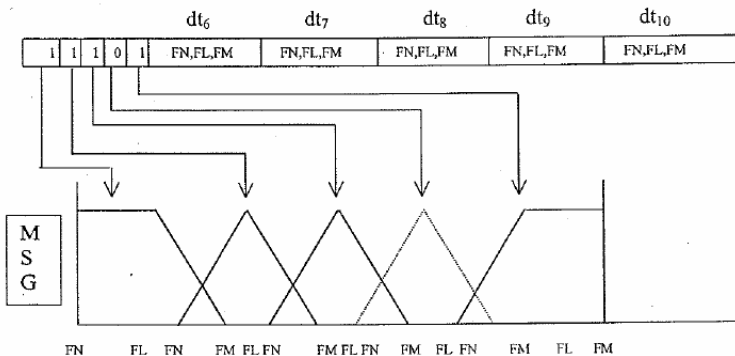
The new strings created by the hierarchical genetic fuzzy control algorithm are decoded and their fitness function values are calculated, which are given in table 3.7.

**Table 3.7: Determination of fitness value for new population strings**

No.	New population (NP)	Fitness function $f$ using NP
1	11011	729
2	10001	289
3	11101	841
4	01001	81

By the above method the average fitness has improved for the maximum fitness increasing from 625 to 841, the resulting string is 11101 (decision tables for system performance). This value proves to be a very good performance of the system. We propose 11101 population string for the next process of the system. Now our optimized membership function of hierarchical genetic fuzzy control algorithm (new process design) is given by the figure 3.21.

**Figure 3.21 : New Process Design HGFC**





## To optimize new HGFCFA Design rules

As in the earlier case apply DNA formation to find new process control variable

**Figure 3.22: Population string or control genes = {11101}**

Control genes					Parametric genes (Decision tables)					
1	1	1	0	1		dt <sub>6</sub>	dt <sub>7</sub>	dt <sub>8</sub>	dt <sub>9</sub>	dt <sub>10</sub>

The DNA structure is adopted to both control genes and parameter genes to optimize the gene structure.

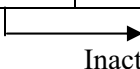
**Figure 3.22a: New populations string with DNA formation**

TAF	Control genes					Parametric genes (Decision tables)						
1	0	1	1	1	0	1		dt <sub>6</sub>	dt <sub>7</sub>	dt <sub>8</sub>	dt <sub>9</sub>	dt <sub>10</sub>

Now it can be seen that the possible encoding is as follows:

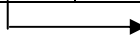
**Figure 3.22b: Possible encoding**

Active genes				
1	1	1	1	1
1	1	1	0	1


 Inactive genes

**Figure 3.22c: Possible encoding**

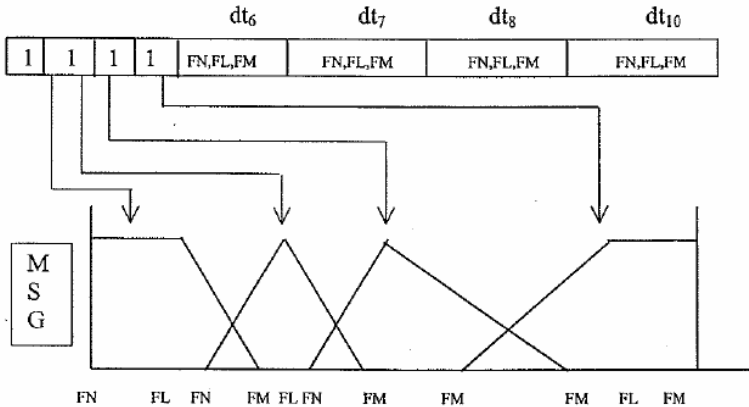
Control genes				
1	1	1	0	1
dt <sub>1</sub>	dt <sub>2</sub>	dt <sub>3</sub>	dt <sub>4</sub>	dt <sub>5</sub>


 x<sub>4</sub> is not formed in the next generation

In this chapter the DNA formation is applied to the new hierarchical genetic fuzzy control algorithm process design given in figure 3.21 to reduce the rules of the new process control variable.

By using the optimized membership function of the hierarchical genetic fuzzy control algorithm, 25 fuzzy rules are obtained to find best flow types in decision tables for the next process of system. After applying the DNA formation to the new optimized population string only 16 fuzzy rules are obtained is shown in figure 3.23. Now fuzzy rules minimize from 25 to 16 which is illustrated in the following diagram; that is the decision table  $dt_9$  is not necessary for the next process.

**Figure 3.23: Optimized New Process Design HGFC A**



### 3.5 Conclusions

We have used, hierarchical genetic fuzzy control algorithms to find a new process control variable with minimum valid condition. The process control variables are taken as a population string, and a new process control variable, with minimized rules using selection, crossover and DNA formation is obtained.

**The merits of these methods are as follows:**

1. Finding a new process control variable from the past happenings process control variables.
2. Identifying unnecessary rules in the new process control variable, thus reducing the rules from 25 to 16.
- 3.

**The merits of the new process control variable in chemical industry are as follows:**

1. It reduces the process time
2. New process variable does not affect the system performance.
3. The new process variable will give the product with minimum raw materials.
4. The new process control variable will reduce wastages during the process time and there by minimize the pollution.
5. The main advantage is, it will guarantee safety of the system performance and it will improve the system performance and there by minimized the pollution.

It is to be noted that we have only given the sketch of hoe HGFC works when we have past data in hand.

## Chapter Four

# IDENTIFICATION OF THE MAXIMUM AGE GROUP IN WHICH THE AGRICULTURAL LABOURERS SUFFER HEALTH HAZARDS DUE TO CHEMICAL POLLUTION USING RTD MATRIX

### 4.1 Introduction

In this chapter, we give an algebraic approach to the health hazards faced by agriculture labourers due to chemical pollution in Chengalpet District in Tamil Nadu. First by the term chemical pollution we mean the pollution due to the spray of pesticides and insecticides, also the pollution of the grain due to the use of fertilizer, which are mainly chemicals. From our interviews and the fieldwork undertaken we saw that agriculture labourer who are free of any tensions or mental problems suffer from these symptoms, which were mainly due to chemical pollution, this was spelt out by 95% of the interviewed

labourers. They all described their health problems was acute during and after the spray of pesticides, insecticides and manuring. It is pertinent to mention that they informed us that two persons died in the agriculture field itself while they were spraying the pesticides.

They said these victims fainted in the field and before they could be taken to the hospital they died of suffocation due to the spray. Further, the older people were very angry at this event. In fact, they expressed in those days the agriculture methods used by them were really eco friendly. Due to modernization nowadays the pesticides and insecticides are sprayed on the fields using helicopters, which has largely affected the agriculture labourers. For the total atmosphere is polluted by these methods. This study is significant because most of the villages in India can adopt the same procedure and to the best of our knowledge no one has ever cared to study the health hazards suffered by these people due to chemical pollution. Thus our study can be adopted to any agriculture field/village in India. We approach the problem of pollution by determining the peak age group in which they are maximum affected by pollution. By knowing this age group the government at least can take steps to treat them and rehabilitate them and give medicine which will antinode the chemicals due to which they are suffering these health problems. We analyze these problems using fuzzy matrix. We call the RTD matrix defined in [51, 60-1] as the fuzzy matrix for they take their entries from the set  $\{-1,0,1\}$ . So the terms RTD matrix or fuzzy matrix mean one and the same matrix. The raw data, which we have obtained from the 110 agriculture labours, is transformed in to time dependent matrices. After obtaining the time dependent matrices using the techniques of average and standard deviation we identify the peak age group in which they suffer the maximum health hazard. Identification of the maximum age group will play a vital role in improving their health conditions by providing them the best health facilities, like medicine, good food and better hygiene.

To the best of our knowledge such study has not been mathematically carried out by anyone. The study in general using these fuzzy matrix have been carried out in the analysis of

transportation of passenger problems [61]. Apart from this we do not have any study using these techniques. The raw data (health problems) under investigation has been classified under five broadheads: 1. Cardiovascular problems, 2. Digestive problems, 3. Nervous problems, 4. Respiratory problems 5. Other problems. These five major heads are further divided into subheads. These five major heads with the introduction and conclusion forms the seven sections of this chapter. Now each of these five broad heads are dealt separately. For each broad head is divided into 8 or more or less subheads and fuzzy matrix /RTD matrix model described in [51, 60-1] is adopted. These subheads forms the columns of the matrix and the age of the agriculture labourers grouped in varying intervals forms the rows of the RTD matrix. Estimation of the maximum age group is a five stage process. This chapter has three sections and each of them deal with different types of symptoms and diseases suffered by agriculture labourer in all age groups. We have varied the age group as well as the parameter  $\alpha \in [0,1]$  to obtain the most sensitive result. We have grouped the data under three sets of groups. We have formed in all the cases the matrix as well as the graphs. It is pertinent to mention here that such type of study among agriculture labourers and their health problem is for the first time analyzed by these methods. Further, we wish to state that this is the most simple and very effective method of analysis for even the lay man looking at the graph can conclude under which age group they suffer which type of disease. All conclusions based on our study is given at the end of this chapter.

#### **4.2 Estimation of the Maximum Age Group of the Agricultural Labourers having Cardio Vascular Problem due to Chemical Pollution, using RTD matrices**

One of the major and broad heads of study of the health problems faced by the agricultural labourers was the cardiovascular problem under this disease the agriculture labourers suffered eight symptoms viz. Chest pain, Pain at the rib's sides, Back pain, Shoulder pain, Left arm and leg pain,

Swollen limbs, Burning Chest and Blood Pressure (low or high B.P) which are taken as the columns of the initial raw data matrix. The age group in years 20-30, 31-43 and 44-65 are taken as the rows of the matrix. The estimation of the maximum age group is a five-stage process. In the first stage we give the matrix representation of the raw data. Entries corresponding to the intersection of rows and columns are values corresponding to a live network. The  $3 \times 8$  matrix is not uniform i.e. the number of individual years in each interval may not be the same. So in the second stage we in order to obtain an unbiased uniform effect on each and every data so collected, transform this initial matrix into an Average Time Dependent Data (ATD) matrix. To make the calculations easier and simpler we in the third stage using the simple average techniques convert the above average time dependent data matrix in to a matrix with entries  $e_{ij} \in \{-1, 0, 1\}$ . For more refer [50, 60-1].

We name this matrix as the Refined Time Dependent data matrix (RTD matrix) or as the fuzzy matrix. The value of  $e_{ij}$  corresponding to each entry is determined in a special way described in [50, 60-1].

At the fourth stage using the fuzzy matrices we obtain the Combined Effect Time Dependent Data matrix (CETD matrix), which gives the cumulative effect of all these entries. In the final stage we obtain the row sums of the CETD matrix. The tables given are self-explanatory at each stage. The graphs of the RTD matrix and CETD matrix are given.

#### **4.2.1 Estimation of maximum age group of agriculture labourers with pollution related cardio vascular problem, using $3 \times 8$ matrices**

Initial raw data matrix of cardio vascular problem of order  $3 \times 8$

Years	Chest pain	Pain at the rib's sides	Back pain	Shou-lder pain	Left Arm and leg pain	Swollen limbs	Burning Chest	B.P
20-30	23	18	24	16	29	10	16	10

31-43	38	32	38	31	35	18	33	10
44-65	22	21	21	22	20	11	20	5

The ATD Matrix of Cardio Vascular problem of order  $3 \times 8$

Years	Chest pain	Pain at the rib's sides	Back pain	Shou-lder pain	Left Arm and leg pain	Swo-llen limbs	Burning Chest	B.P
20-30	2.09	1.64	2.18	1.46	2.64	0.91	1.46	0.91
31-43	2.92	2.46	2.92	2.39	2.69	1.39	2.54	0.77
44-65	1	0.95	0.95	1	0.91	0.5	0.91	0.23

The Average and the Standard Deviation of the above ATD matrix

Average	2.00	1.68	2.02	1.62	2.08	0.93	1.64	0.64
Standard deviation	0.96	0.76	0.995	0.71	1.01	0.45	0.83	0.36

The RTD matrix for  $\alpha = 0.15$

$$\begin{bmatrix} 0 & 0 & 1 & -1 & 1 & 0 & -1 & 1 \\ 1 & 1 & 1 & 1 & 1 & 1 & 1 & 1 \\ -1 & -1 & -1 & -1 & -1 & -1 & -1 & -1 \end{bmatrix}$$

The row sum matrix

$$\begin{bmatrix} 1 \\ 8 \\ -8 \end{bmatrix}$$

The RTD matrix for  $\alpha = 0.35$

$$\begin{bmatrix} 0 & 0 & 0 & 0 & 1 & 0 & 0 & 1 \\ 1 & 1 & 1 & 1 & 1 & 1 & 1 & 0 \\ -1 & -1 & -1 & -1 & -1 & -1 & -1 & -1 \end{bmatrix}$$

The row sum matrix

$$\begin{bmatrix} 2 \\ 7 \\ -8 \end{bmatrix}$$



The RTD matrix for  $\alpha = 0.45$

$$\begin{bmatrix} 0 & 0 & 0 & 0 & 1 & 0 & 0 & 1 \\ 1 & 1 & 1 & 1 & 1 & 1 & 1 & 0 \\ -1 & -1 & -1 & -1 & -1 & -1 & -1 & -1 \end{bmatrix}$$

The row sum matrix

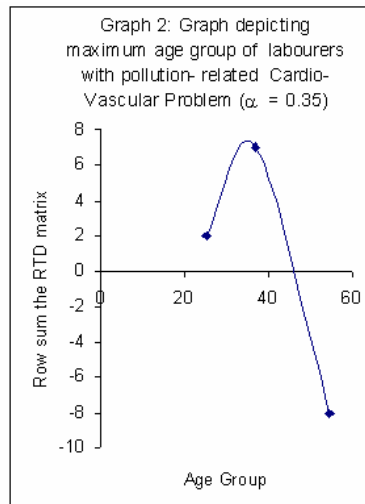
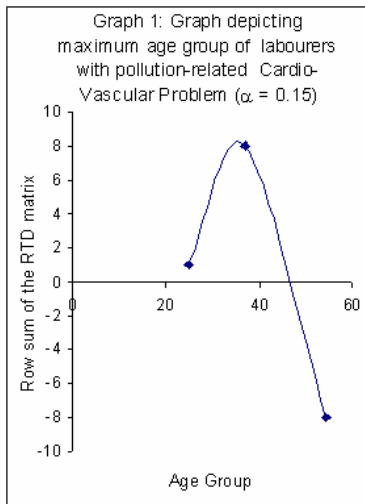
$$\begin{bmatrix} 2 \\ 7 \\ -8 \end{bmatrix}$$

The RTD matrix for  $\alpha = 0.75$

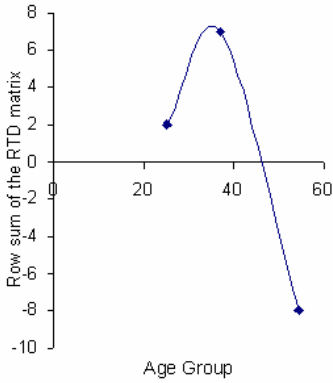
$$\begin{bmatrix} 0 & 0 & 0 & 0 & 0 & 0 & 0 & 0 \\ 1 & 1 & 1 & 1 & 0 & 1 & 1 & 0 \\ -1 & -1 & -1 & -1 & -1 & -1 & -1 & -1 \end{bmatrix}$$

The row sum matrix

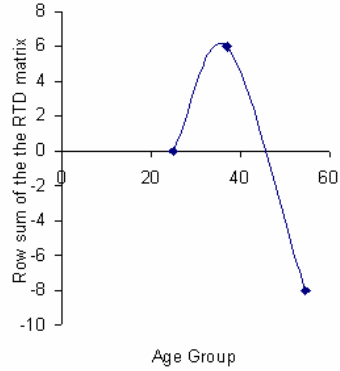
$$\begin{bmatrix} 0 \\ 6 \\ -8 \end{bmatrix}$$



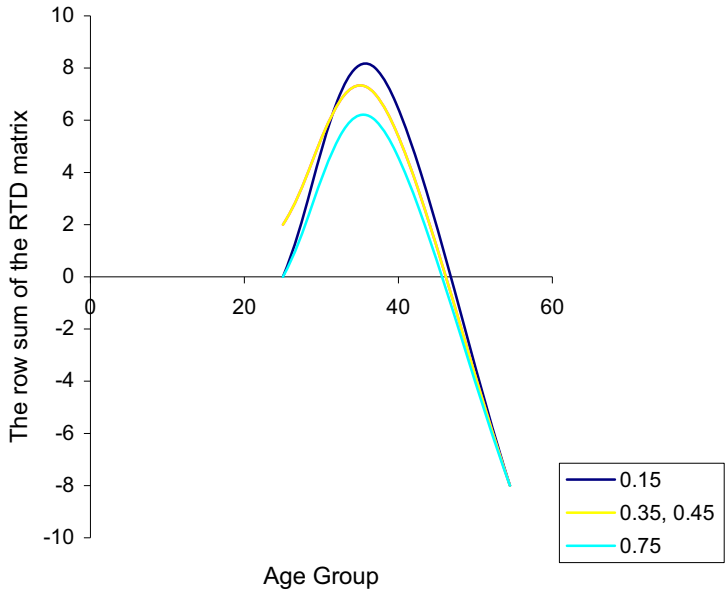
Graph 3: Graph depicting maximum age group of labourers with pollution-related Cardio-Vascular Problem ( $\alpha = 0.45$ )



Graph 4: Graph depicting maximum age group of labourers with pollution-related Cardio-Vascular Problem ( $\alpha = 0.75$ )

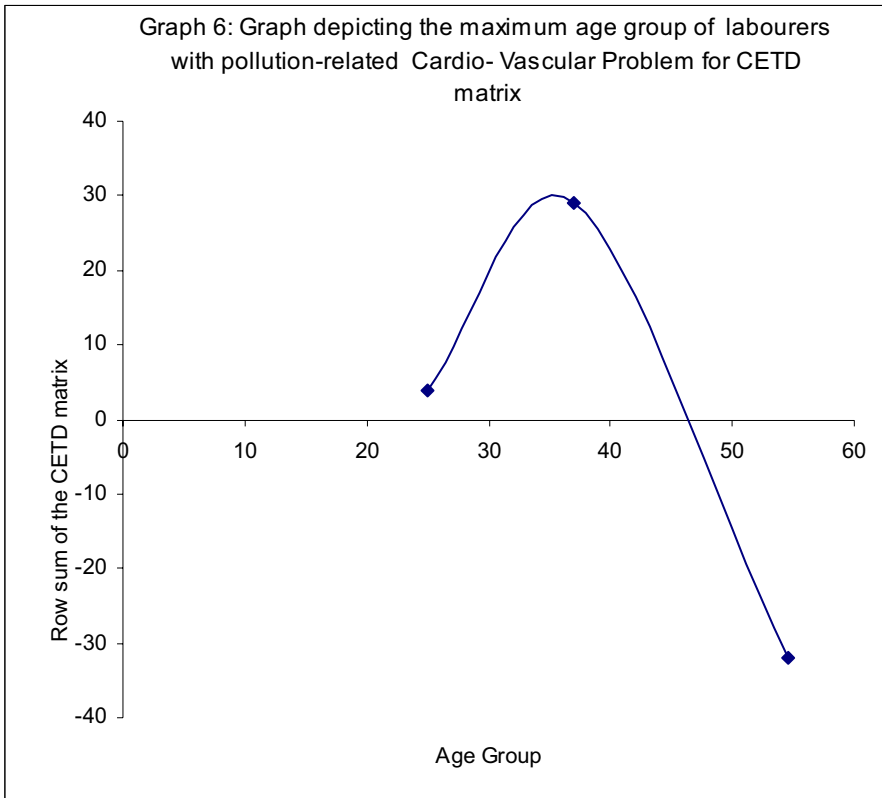


Graph 5: Graphical comparison of the maximum age group of the labourers who are affected by Cardiovascular problem



From the above analysis, we observe that the maximum age group getting cardiovascular problem has not changed with the change in the value of the parameter from 0 to 1. The mathematical inference is that the maximum age group of agricultural labourer to have cardio vascular problem is 35-37, and the Combined Effect Time Dependent data matrix also confirm the same result.

The CETD Matrix	The row sum matrix
$\begin{bmatrix} 0 & 0 & 0 & -1 & 3 & 0 & -1 & 3 \\ 4 & 4 & 4 & 4 & 4 & 4 & 4 & 1 \\ -4 & -4 & -4 & -4 & -4 & -4 & -4 & -4 \end{bmatrix}$	$\begin{bmatrix} 4 \\ 29 \\ -32 \end{bmatrix}$



**4.2.2 Estimation of maximum age group of agriculture labourer with pollution related cardio vascular problem, using  $4 \times 8$  matrices**

Now to make the study more sensitive we increase the number of rows by 4 and see whether the decision arrived is more sensitive to the earlier one we have discussed. Thus we give the raw data of  $4 \times 8$  matrix.

Initial raw data matrix of cardio vascular problem of order  $4 \times 8$

Years	Chest pain	Pain at the rib's sides	Back pain	Shou-lder pain	Left Arm and eg pain	Swo-llen limbs	Burning Chest	B.P
20-30	23	18	24	16	29	10	16	10
31-36	18	15	20	14	17	6	13	5
37-43	20	17	18	17	18	12	20	5
44-65	22	21	21	22	20	11	20	5

The ATD Matrix for Cardio Vascular problem of order  $4 \times 8$

Years	Chest pain	Pain at the rib's sides	Back pain	Shou-lder pain	Left Arm and leg pain	Swo-llen limbs	Burning Chest	B.P
20-30	2.09	1.64	2.18	1.46	2.64	0.91	1.46	0.91
31-36	3	2.5	3.33	2.33	2.83	1	2.17	0.83
37-43	2.86	2.43	2.57	2.43	2.57	1.71	2.86	0.71
44-65	1	0.95	0.95	1	0.91	0.5	0.91	0.23

The Average and the Standard Deviation for the above ATD matrix

Average	2.24	1.88	2.26	1.81	2.24	1.03	1.085	0.67
Standard deviation	0.92	0.73	0.99	0.69	0.89	0.50	0.85	0.30

The RTD matrix for  $\alpha = 0.15$

$$\begin{bmatrix} -1 & -1 & 0 & -1 & 1 & -1 & -1 & 1 \\ 1 & 1 & 1 & 1 & 1 & 0 & 1 & 1 \\ 1 & 1 & 1 & 1 & 1 & 1 & 1 & 0 \\ -1 & -1 & -1 & -1 & -1 & -1 & -1 & -1 \end{bmatrix}$$

The row sum matrix

$$\begin{bmatrix} -3 \\ 7 \\ 7 \\ -8 \end{bmatrix}$$

The RTD matrix for  $\alpha = 0.35$

$$\begin{bmatrix} 0 & 0 & 0 & -1 & 1 & 0 & 1 & 1 \\ 1 & 1 & 1 & 1 & 1 & 0 & 1 & 1 \\ 1 & 1 & 0 & 1 & 1 & 1 & 1 & 0 \\ 1 & -1 & -1 & -1 & -1 & -1 & 0 & -1 \end{bmatrix}$$

The row sum matrix

$$\begin{bmatrix} 2 \\ 7 \\ 6 \\ -5 \end{bmatrix}$$

The RTD matrix for  $\alpha = 0.45$

$$\begin{bmatrix} 0 & 0 & 0 & -1 & 0 & 0 & 0 & 1 \\ 1 & 1 & 1 & 1 & 1 & 0 & 0 & 1 \\ 1 & 1 & 0 & 1 & 0 & 1 & 1 & 0 \\ 1 & -1 & -1 & -1 & -1 & -1 & 0 & -1 \end{bmatrix}$$

The row sum matrix

$$\begin{bmatrix} 0 \\ 6 \\ 5 \\ -5 \end{bmatrix}$$

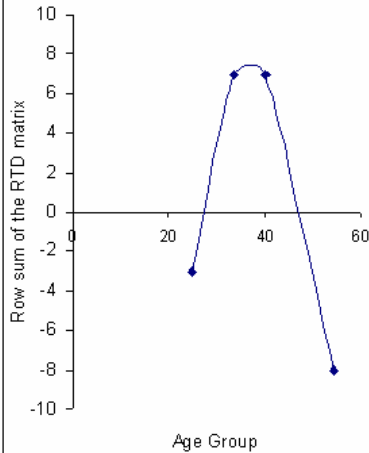
The RTD matrix for  $\alpha = 0.75$

$$\begin{bmatrix} 0 & 0 & 0 & 0 & 0 & 0 & 0 & 1 \\ 1 & 1 & 1 & 0 & 0 & 0 & 0 & 0 \\ 0 & 0 & 0 & 1 & 0 & 1 & 1 & 0 \\ -1 & -1 & -1 & -1 & -1 & -1 & 0 & -1 \end{bmatrix}$$

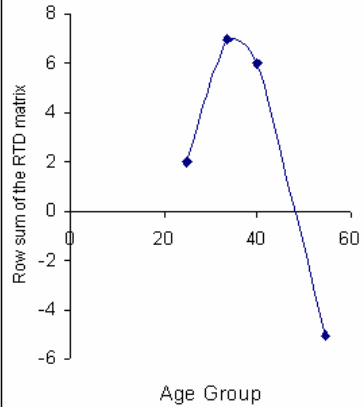
The row sum matrix

$$\begin{bmatrix} 1 \\ 3 \\ 3 \\ -7 \end{bmatrix}$$

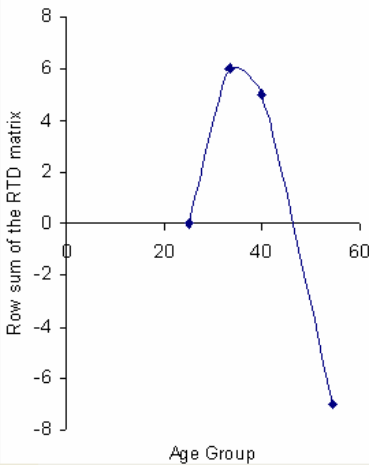
Graph 7: Graph depicting maximum age group of labourers with pollution related Cardio Vascular Problem for  $\alpha = 0.15$



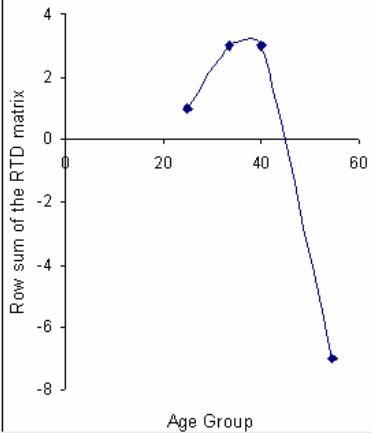
Graph 8: Graph depicting maximum age group of labourers with pollution related Cardio Vascular Problem for  $\alpha = 0.35$



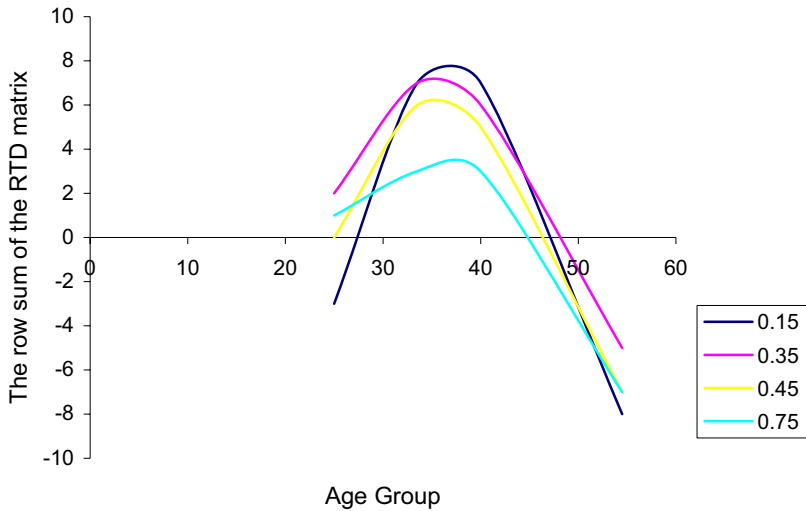
Graph 9: Graph depicting maximum age group of labourers with pollution related Cardio Vascular Problem for  $\alpha = 0.45$



Graph 10: Graph depicting maximum age group of labourers with pollution related Cardio Vascular Problem for  $\alpha = 0.75$



Graph 11: Graphical comparison of the maximum age group of the labourers who are affected by Nervous problem

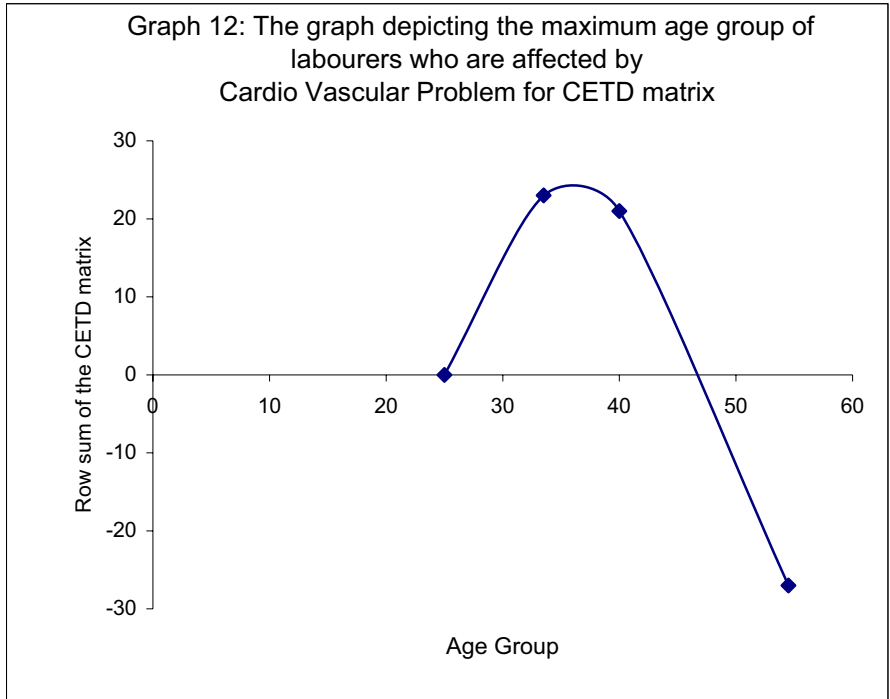


The CETD Matrix

$$\begin{bmatrix} -1 & -1 & 0 & -3 & 2 & -1 & 0 & 4 \\ 4 & 4 & 4 & 3 & 3 & 0 & 2 & 3 \\ 3 & 3 & 1 & 4 & 2 & 4 & 4 & 0 \\ -2 & -4 & -4 & -4 & -4 & -4 & -1 & -2 \end{bmatrix}$$

The row sum matrix

$$\begin{bmatrix} 0 \\ 23 \\ 21 \\ -27 \end{bmatrix}$$



We observe from the above graph that

1. The Cardio vascular problem starts only at the age of 25
2. The maximum age for getting cardio vascular problem is 33-36
3. The peak period for a heart problem is 55.
4. The above three results also confirmed from the CETD matrix

#### **4.2.3 Estimation of maximum age group of agriculture labourer with pollution related cardio vascular problem, using $5 \times 8$ matrices**

Now to make the study more sensitive we increase the number of rows by 5 and see whether the decision arrived is more sensitive to the earlier one.



The Initial Raw Data Matrix of Cardio Vascular problem of order  $5 \times 8$

Years	Chest pain	Pain at the rib's sides	Back pain	Shoulder pain	Left arm and leg pain	Swollen limbs	Burning Chest	B.P
20-24	2	1	3	1	3	0	2	1
25-30	21	17	21	15	26	10	14	9
31-36	18	15	20	14	17	6	13	5
37-43	20	17	18	17	18	12	20	5
44-65	22	21	21	22	20	11	20	5

The ATD Matrix for Cardio Vascular problem of order  $5 \times 8$

Years	Chest pain	Pain at the rib's sides	Back pain	Shou- lder pain	Left Arm and leg pain	Swo- llen limbs	Burning Chest	B.P
20-24	0.4	0.2	0.6	0.2	0.6	0	0.4	0.2
25-30	3.5	2.83	3.5	2.5	4.33	1.67	2.33	1.5
31-36	3	2.5	3.33	2.33	2.83	1	2.17	0.83
37-43	2.86	2.43	2.57	2.43	2.57	1.71	2.86	0.71
44-65	1	0.95	0.95	1	0.91	0.5	0.91	0.23

Average and the Standard Deviation of the above given ATD matrix

Average	2.15	1.78	2.19	1.69	2.25	0.98	1.73	0.69
Standard deviation	1.36	1.14	1.34	1.03	1.52	1.74	1.03	0.53

The RTD matrix for  $\alpha = 0.1$

$$\begin{bmatrix} -1 & -1 & -1 & -1 & -1 & -1 & -1 & -1 \\ 1 & 1 & 1 & 1 & 1 & -1 & 1 & 1 \\ 1 & 1 & 1 & 1 & 1 & 0 & 1 & 1 \\ 1 & 1 & 1 & 1 & 1 & 1 & 1 & 0 \\ -1 & 1 & -1 & -1 & -1 & -1 & -1 & -1 \end{bmatrix}$$

The row sum matrix

$$\begin{bmatrix} -8 \\ 6 \\ 7 \\ 7 \\ -6 \end{bmatrix}$$

The RTD matrix for  $\alpha = 0.15$

$$\begin{bmatrix} -1 & -1 & -1 & -1 & -1 & -1 & -1 & -1 \\ 1 & 1 & 1 & 1 & 1 & 1 & 1 & 1 \\ 1 & 1 & 1 & 1 & 1 & 0 & 1 & 1 \\ 1 & 1 & 1 & 1 & 1 & 1 & 1 & 0 \\ -1 & 0 & -1 & -1 & -1 & -1 & -1 & -1 \end{bmatrix}$$

The row sum matrix

$$\begin{bmatrix} -8 \\ 8 \\ 7 \\ 7 \\ -7 \end{bmatrix}$$

The RTD matrix for  $\alpha = 0.2$

$$\begin{bmatrix} -1 & -1 & -1 & -1 & -1 & -1 & -1 & -1 \\ 1 & -1 & 1 & 1 & 1 & 1 & 1 & 1 \\ 1 & 1 & 1 & 1 & 1 & 0 & 1 & 1 \\ 1 & 1 & 1 & 1 & 1 & 1 & 1 & 0 \\ -1 & -1 & -1 & -1 & -1 & -1 & -1 & -1 \end{bmatrix}$$

The row sum matrix

$$\begin{bmatrix} -8 \\ 6 \\ 7 \\ 7 \\ -8 \end{bmatrix}$$

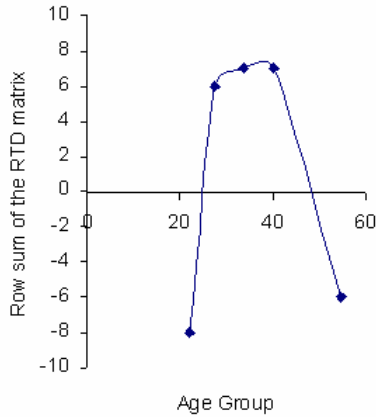
The RTD matrix for  $\alpha = 0.35$

$$\begin{bmatrix} -1 & -1 & -1 & -1 & -1 & -1 & -1 & -1 \\ 1 & 1 & 1 & 1 & 1 & 1 & 1 & 1 \\ 1 & 1 & 1 & 1 & 1 & 0 & 1 & 0 \\ 1 & 1 & 0 & 1 & 0 & 1 & 1 & 0 \\ -1 & -1 & -1 & -1 & -1 & -1 & -1 & -1 \end{bmatrix}$$

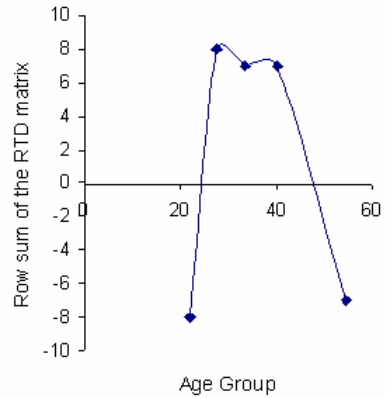
The row sum matrix

$$\begin{bmatrix} -8 \\ 8 \\ 6 \\ 5 \\ -8 \end{bmatrix}$$

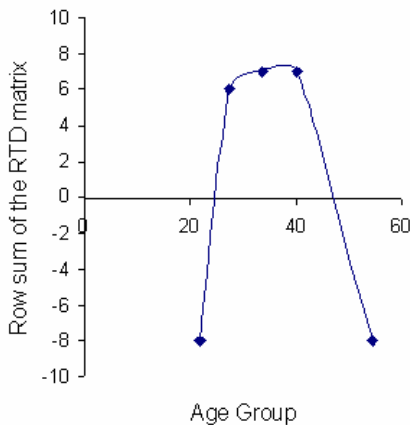
Graph 13: Graph depicting maximum age group of labourers with pollution related Cardio Vascular problem ( $\alpha = 0.1$ )



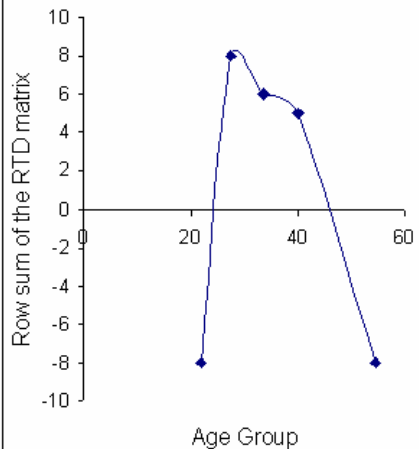
Graph 14: Graph depicting maximum age group of labourers with pollution related Cardio Vascular problem ( $\alpha = 0.15$ )



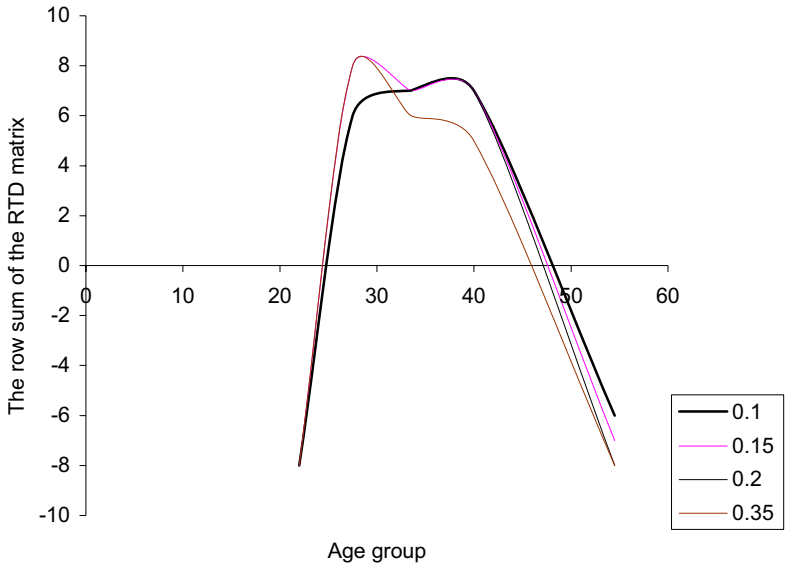
Graph 15: Graph depicting maximum age group of labourers with pollution related Cardio Vascular problem ( $\alpha = 0.2$ )



Graph 16: Graph depicting maximum age group of labourers with pollution related Cardio Vascular problem ( $\alpha = 0.35$ )



Graph 17: Graphical comparison of the maximum age group of the labourers who are affected by Cardio vascular problem



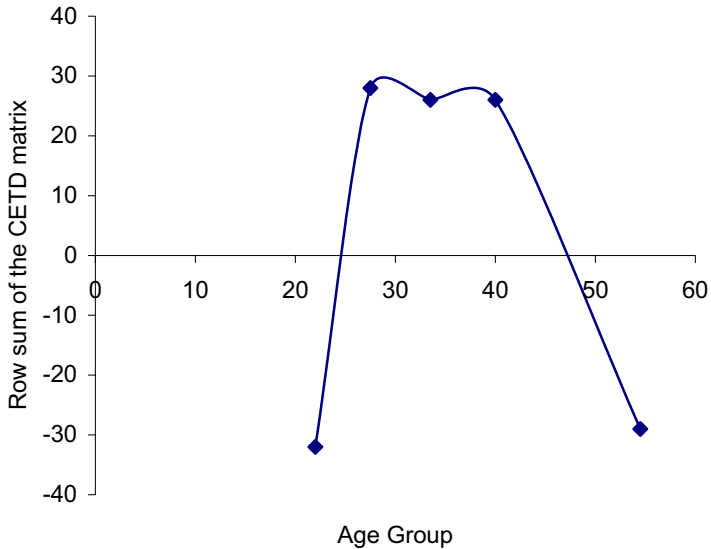
The CETD matrix

$$\begin{bmatrix} -4 & -4 & -4 & -4 & -4 & -4 & -4 & -4 \\ 4 & 2 & 4 & 4 & 4 & 2 & 4 & 4 \\ 4 & 3 & 4 & 4 & 4 & 0 & 4 & 3 \\ 4 & 4 & 3 & 4 & 3 & 4 & 4 & 0 \\ -3 & -2 & -4 & -4 & -4 & -4 & -4 & -4 \end{bmatrix}$$

The row sum matrix

$$\begin{bmatrix} -32 \\ 28 \\ 26 \\ 26 \\ -29 \end{bmatrix}$$

Graph 18: The graph depicting the maximum age group of the labourers who are affected by Cardio Vascular problem



#### 4.2.4 Conclusions

First contrary to the natural happening that a person after 40 has more chances of getting the cardio vascular disease. We see in case of these agricultural labourers who toil in the sun from day to dawn and who have no other mental tensions or hyper tensions become victims of all types of cardio vascular symptoms mainly due to the evil effects of chemicals used as the pesticides and insecticides. It is unfortunate to state that most of the agriculture labour suffer symptom of cardio vascular disease in the very early age group of 35-37 which is surprising. For there is no natural rhyme or reason for it for even after work hours they do not have traces of tensions or humiliation to be more precise they after a long days physical labour can have a peaceful sleep but on the contrary they suffer serious symptoms like B.P., chest pain burning heart/chest etc. Of the 110 agriculture labourers interviewed we saw 83 of them suffered

from the cardio vascular symptom of which 38 of them were from the age group 31 to 43. Only 22 from the age group 41 to 65 which is against the medical laws for they should be in large number the two reasons for this have already been attributed. Also 33 of them in the age group 31 to 43 had burning chest symptoms also. They all attributed this mainly due to the pollution by chemicals. For uniformly all of them felt that after the spray of pesticides they suffered more of the symptoms say for at least a fortnight or more, due to the evil effects of the chemicals used in the pesticides and insecticides. It is unfortunate to state that most of the agriculture labourers suffer the symptom of cardio vascular disease in the very early age group of 35-37, which is surprising. As people who live after sixty are 2% and in fifties are less than the 10% we see people suffering from cardio vascular disease and the related symptoms in the age group 44-65 are negligible seen from the large negative deviation. Also the age group 20-24 is negative for this age group forms the migrants due to agriculture failure they are saved from the clutches of the chemical pollution. This is easily seen from the graphs.

### **4.3 Conclusion**

The respiratory symptoms like breathing with difficulty, allergy, asthma are the symptomatic indications of environmental pollution, which is true in urban community. But rural areas can surely boast about the pollutant free environment. We have worked out in the similar manner for other diseases and symptoms elaborately in [60] but here only conclusion based on our study is given. In this graph, the above symptoms are at its peak at 29 yrs of age. Falling in the age range of 20-30 yrs. One can also suggest that alcoholism, drugs and smoke addiction as reasons for this. But medical history have put in the fact that such addiction has its symptomatic indication after the crossing of middle age. Out of 110 people interviewed 79 of them complained of difficulty in breathing and 80 complained of coughing and 83 of sneezing. These facts make us to point out that influence of the spraying of the pesticides using the modern

technique like helicopter is one of the major reasons for the above problem in such a pollutant free environment. Thus the use of modern technique has only polluted the entire environment their by making the poor agriculture laborer as a passive victim of respiratory problem for which they are not even in a situation to get any type of medical aid for all the 11 villages which we surveyed have no health centres.

Thus the use of pesticides and insecticides has not only created health hazard to the agricultural labourers but also polluted the environment beyond repair by killing several edible species and above all making the land infertile there by drastically reducing yield and resulting in farmers suicide. Unless the environmental pollution is controlled the land will become totally infertile leaving the farmers in lurch!

## Chapter Five

# MINIMIZATION OF $\text{SO}_x$ AND $\text{NO}_x$ USING FUZZY CONTROL THEORY IN CEMENT INDUSTRIES TO REDUCE POLLUTION

### 5.1 Introduction

In this chapter the fuzzy control method is applied to the kiln system in cement industries. Here we try to find the correct speed and pressure of the kiln for proper mixing of  $\text{SO}_x$  and  $\text{NO}_x$  with the raw materials. By this way we try to minimize the  $\text{SO}_x$  and  $\text{NO}_x$  pollution in environment from cement industries. The wastage of  $\text{SO}_x$  and  $\text{NO}_x$  are arising in kiln of cement industry during the process, and these  $\text{SO}_x$  and  $\text{NO}_x$  waste gases enter the environment either as a component of acid rain or as a solid reaction products, which become components of what is known as dry deposition. The harmful effects of acid rain and its



precursors are being studied and debated at the present time. These effects may include damage to many natural systems, man and man-made objects. At high concentrations, inhalable particulate is known to affect visibility, human health, respiratory system, personal comfort, plant health and economic values. So, the  $\text{SO}_x$  and  $\text{NO}_x$  minimization is a very important issue in the cement factory. This chapter uses fuzzy control method to find the precise set point of pressure and speed of the kiln for proper mixing of the  $\text{SO}_x$  and  $\text{NO}_x$  with raw materials. The analysis of our study is focused on the cement industry. Here this chapter approaches the problem of finding the speed and pressure of the kiln and minimizing the wastage of  $\text{SO}_x$  and  $\text{NO}_x$  using mean of maximum method of fuzzy control. Finding the speed and pressure of the kiln plays a vital role in proper mixing of  $\text{SO}_x$  and  $\text{NO}_x$  with raw materials and minimizing of  $\text{SO}_x$  and  $\text{NO}_x$  pollution in environment.

In 1989, Haspel has studied the minimization of waste gas  $\text{NO}_x$  from cement industries and he tried to give conditions to maintain the quality of clinker and reduce the wastages of  $\text{NO}_x$  using  $\text{NO}_x$  based computer control. By using the conditions some changes are made in kiln system to minimize the  $\text{NO}_x$  wastages and maintain the quality of clinker.

In 1995 McQueen et al., used common  $\text{NO}_x$  control technologies to control  $\text{NO}_x$  emission from kiln. They mainly concentrated on temperature and combustion modification like air combustion, combustion air preheat.

In 1996, Martin Sanchez and Jose Rodellar concentrated on speed and pressure of the kiln. They used Adaptive Predictive Control (APC) to optimize the range of set points of pressure and range of set points of speed of kiln to minimize  $\text{SO}_x$  and  $\text{NO}_x$  wastages. They made a significant step by introducing APC to control or optimize the range of set points of pressure level and speed level of the kiln. But this method did not give a precise set point of pressure level and speed level of the kiln.

1. The waste gas minimization is heavily dependent on experience. Usually, the behaviour of a process system generating waste gas cannot be described readily through formal mathematical model. The qualitative analysis of the mechanism

of dealing with gas is required.

2. The available information pertaining to the waste gas minimization is frequently uncertain, imprecise, incomplete and qualitative. Quite often it can be expressed only in linguistic form. Under these circumstances, it is very difficult, if not possible, to resort to usual methods to design and control a process with waste gas minimization in mind.

So here we approach the problem of finding speed and pressure of the kiln using fuzzy control method. This thesis uses the kiln feed and coal feed as input parameters to obtain the kiln speed and pressure of kiln using fuzzy control method. Here the input parameter of kiln feed and coal feed are converted into fuzzy membership functions and the mean of the maximum method is used to find the kiln speed and pressure of kiln.

## 5.2 Description of the Problem

Using the raw data available from any cement industry, this chapter analyses the raw data via mean of maximum method of fuzzy control to find (i) speed of kiln and (ii) pressure of kiln so as to minimize the waste gas  $\text{SO}_x$  and  $\text{NO}_x$ . Thus, this method not only determines the exact speed and pressure of kiln, but also the wastage of  $\text{SO}_x$  and  $\text{NO}_x$  are minimized.

The kiln consists of a long steel shell about 130 meters in length and 5 meters in diameter. The shell is mounted at a slight inclination to the horizontal and is lined with firebricks. The shell rotates slowly, at approximately 1 rev/min and the slurry is fed in at the upper or back end of the kiln. The inclination of the shell and its rotation transports the material through the kiln in about 3 hours 15 minute with a further 45 minute spent in the clinker cooler. The heat in the kiln is provided by pulverized coal mixed with air, referred to as primary air. The hot combustion gases are sucked through the kiln by induction fan at the back end of the kiln.

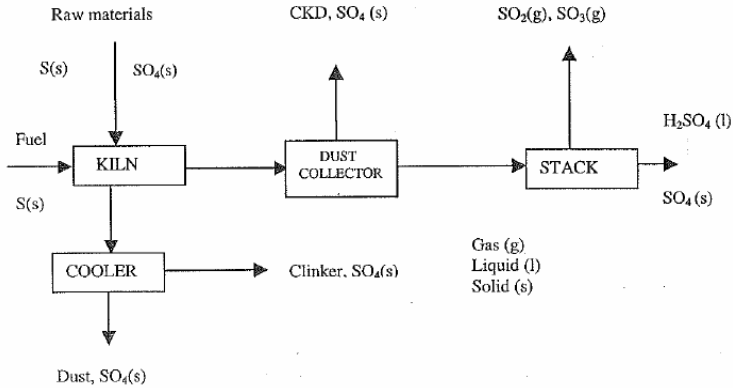
The raw materials used in the manufacture of cement are limestone, gypsum, flyash, slag and pozzolanic materials. Two basic processes used in the manufacturing of cement are the wet

process and the dry process. In these the gaseous emissions from the cement kiln are typically oxides of sulfur, nitrogen and carbon as well as hydrocarbons and particulate matter. The problem of control of these waste gas is difficult one, many different control methods have been tried to control the waste gas over the last 15-20 years. The range of  $\text{NO}_x$  emissions is usually between 1.4-3.1 kilogram per ton of clinker.  $\text{SO}_x$  emissions even when high sulfur coal is used are low in the cement industry because most of the  $\text{SO}_2$  is scrubbed by the calcinations process. The range of  $\text{SO}_x$  emissions is usually between 0.2-1.2 kilogram per ton of clinker in the kiln.

### 5.3 Process Fates of Sulfur in Cement Kiln

The  $\text{SO}_x$  (By  $\text{SO}_x$  it can be  $\text{SO}_2$ ,  $\text{SO}_3$ , or  $\text{SO}_4$ ) emissions from a cement kiln consist mainly of sulfur dioxide. Small amounts of sulfur trioxide ( $\text{SO}_3$ ) usually accompany the  $\text{SO}_2$  out of the stack. When exposed to moisture, the sulfur trioxide forms a sulfuric acid mist, which may exit the stack as well. The sulfur, from which the emissions of  $\text{SO}_x$  are formed, is introduced into a kiln system from the fossil fuel or the raw materials. Sulfur dioxide emissions result directly from the combustion of the fuel or the roasting of pyrite containing raw materials. The process fates of sulfur in a cement kiln system are shown in figure 5.1. In large measure the sulfur is absorbed by materials within the process and leaves the kiln system as a component of the clinker, the clinker dust emissions, the waste Cement Kiln Dust (CKD), or the particulate emissions from the kiln stack. Some sulfur is retained within the kiln system as material buildup or as part of volatile cycle. Sulfur is usually absorbed in the range of 50-90 percent of input. Modern kiln systems of the preheater/ precalciner types tend to have higher rates of  $\text{SO}_2$  absorption, but there are exceptions of this generality if the raw materials contain sulfur in the form of a sulfide. The amount of sulfur that is absorbed into the clinker can have an effect on cement quality due to relationship between sulfur and the alkali metals.

**Figure 5.1: Process fates of sulfur in cement kiln**



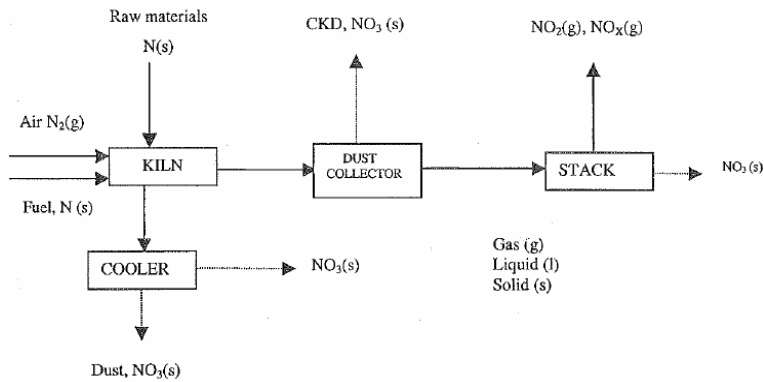
## 5.4 Process Fates of Nitrogen in Cement Kiln

There are several oxides of nitrogen but only nitric oxides (NO) and nitrogen dioxide (NO<sub>2</sub>) emitted from cement kilns in sufficient quantities are of interest here. Nitric oxide usually comprises about 95% of the emissions of nitrogen oxides from the kiln. The colorless nitric oxide gas, however, oxidizes fairly readily in the atmosphere to the reddish-brown nitrogen dioxide gas. It is an accepted practice in the regulatory arena for all emissions of the nitrogen oxides to be expressed as equivalent to NO<sub>2</sub> and be called NO<sub>x</sub> emissions.

The primary source of NO<sub>x</sub> from cement kilns is the combustion of fuels. NO<sub>x</sub> emissions from a combustion process have two basic origins. The first is often called thermal NO<sub>x</sub>, this results from the thermal fixation of nitrogen in the air, which supplies oxygen for combustion. With all other factors being equal; oxygen at the combustion site, fuel chemistry, time, etc., The second is commonly called fuel NO<sub>x</sub> and results from the oxidation of nitrogenous compounds in the fuel. When all other factors are equal, the NO<sub>x</sub> emissions resulting from fuel NO<sub>x</sub> are directly dependent on the nitrogen content of the fuel. Increase of oxygen at the combustion site usually results in higher levels of NO<sub>x</sub> generation from both origins. Organic and inorganic nitrogenous components of the raw materials are

apparently converted to  $\text{NO}_x$ . It is possible that the clinker or CKD captures some of the  $\text{NO}_x$  that is generated in a cement kiln as nitrate. Some  $\text{NO}_x$  will decompose to elemental nitrogen and oxygen as the combustion gases cool. Should the  $\text{NO}_x$  encounter carbon monoxide (CO) within the process, the  $\text{NO}_x$  can be reduced to elemental nitrogen. In most systems, however, the  $\text{NO}_x$  that is generated is largely unaffected and is exhausted from the kiln system to the atmosphere as a gaseous pollutant. The process fates of nitrogen are shown in figure 5.2.

**Figure 5.2: Process fates of nitrogen in cement kiln**



## 5.5 Process under Fuzzy Control System

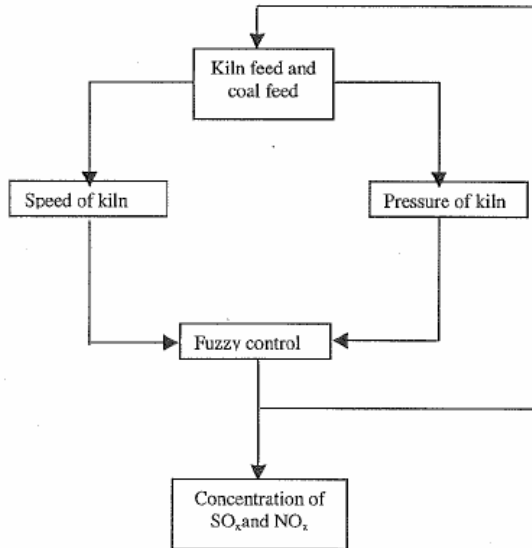
The mixture of raw materials, which is fed into the process, is usually called kiln feed.  $\text{SO}_x$  and  $\text{NO}_x$  concentration is dependent on the kiln feed and coal feed. In the kiln the  $\text{SO}_x$  and  $\text{NO}_x$  level is maintained through control by kiln feed and coal feed respectively. Kiln feed and coal feed are controlled by the pressure and speed of kiln. Usually in cement industry the pressure level and speed level are controlled manually. But the manual control fails several times. So we use fuzzy control to this pressure and speed operation. When we choose correct pressure and speed of the kiln, we mix  $\text{SO}_x$  and  $\text{NO}_x$  properly with the kiln feed and coal feed, by that we reduce  $\text{SO}_x$  and  $\text{NO}_x$  emissions from the kiln. First we convert these pressure and

speed into fuzzy variables. Finally we get solution to minimize  $\text{SO}_x$  and  $\text{NO}_x$  emissions from the kiln using fuzzy control rules. The rules of process of fuzzy control in the kiln is described and is in the following figure 5.3.

**Minimize waste of  $\text{SO}_x$ ,  $\text{NO}_x$  using fuzzy control**

IF  
 Kiln feed, coal feed is (L, M, H)  
 AND  
 Pressure of kiln is (VL, L, M, H, VH)  
 AND  
 Speed of kiln is (VL, L, M, H, VH)  
 THEN  
 $\text{SO}_x$ ,  $\text{NO}_x$  concentration is (VL, L, M, H, VH)

**Figure 5.3: Process under fuzzy control system**



The data taken from Allathur cement factory is used here. Here, the fuzzy control method is adopted to find the speed and pressure of the kiln.

## 5.6 Adaptation of Fuzzy Control Method to find the Speed and Pressure of Kiln for Minimizing the Waste Gas of SO<sub>x</sub> and NO<sub>x</sub>

The fuzzy control method is used to find the speed and pressure of the kiln. Here our aim is to minimize the wastage of SO<sub>x</sub> and NO<sub>x</sub> from the kiln during the process of cement manufacture. These waste gases cause pollution in environment. Here we use the mean of maximum method.

The kiln feed, coal feed in tons per hour (tph), SO<sub>x</sub> and NO<sub>x</sub> concentration in kilograms per ton of clinker (kptc), speed of kiln in rpm and pressure of the kiln in millimeter water gauge (mmwg) are measured from the past happening process in the kiln on a scale from 172 tph to 220 tph, 8.56 tph to 15.70 tph, 0.2 kptc to 1.2 kptc, 1 rpm to 4 rpm and 2024 mmwg to 2069 mmwg respectively. That is we assign the kiln feed to be approximately low (LK) when its value is 102 tph, medium (MK) when its value is 196 tph and high (HK) when its value is 220 tph. In a similar way

Coal feed  $\cong$  {[8.56 tph [low (LC)], 12.13 tph [medium (MC)], 15.70 tph [high (HC)]}.

SO<sub>x</sub>  $\cong$  {[0.2 kptc [very less (VL)], 0.5 kptc [less (L)], 0.8 kptc [medium (M)] 1.1 kptc [high (H)], 1.2 kptc [very high (VH)]}.

NO<sub>x</sub>  $\cong$  {[1.4 kptc [very less (VL)], 1.825 kptc [less (L)], 2.25 kptc [medium (M)] 2.675 kptc [high (H)], 3.1 kptc [very high (VH)]}.

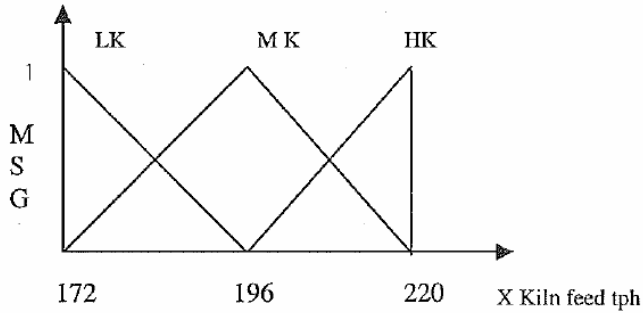
Pressure of kiln  $\cong$  {[2024 mmwg [very less (VL)], 2034 mmwg [less (L)], 2045 mmwg [medium (M)], 2057 mmwg [high (H)], 2069 mmwg [very high (VH)]}.

Speed of kiln  $\cong$  {[1 rpm [very less (VL)], 1.5 rpm [less (L)], 2.5rpm [medium (M)] 3.5 rpm [high (H)], 4 rpm [very high (VH)]}. ( $\cong$  Denotes approximately equal).

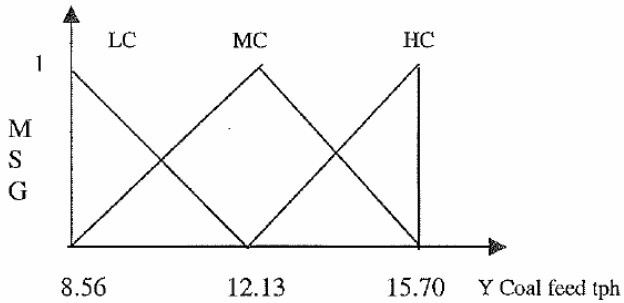
Using fuzzy control to find exact SO<sub>x</sub>, NO<sub>x</sub> emission in each stage and get solution to minimize SO<sub>x</sub> and NO<sub>x</sub> emission in

each stage, the procedure is as follows. The terms of these parameters are presented in figures from 5.4 to 5.9.

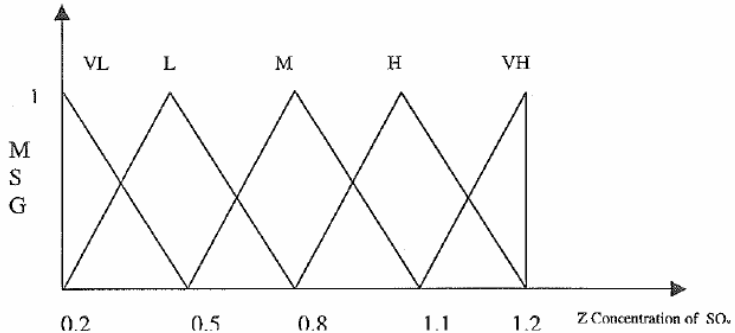
**Figure 5.4: Kiln feed input parameter**



**Figure 5.5: Coal feed input parameter**

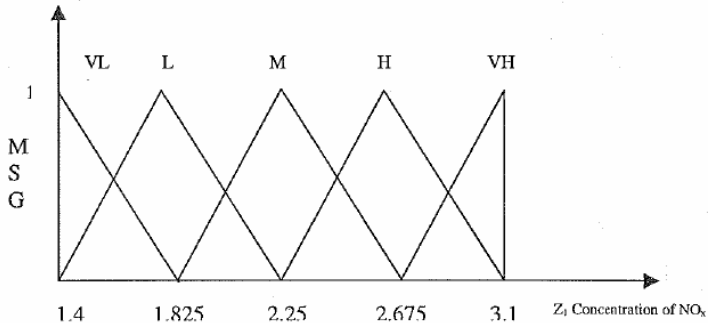


**Figure 5.6: Concentration of SO<sub>x</sub> output parameter**

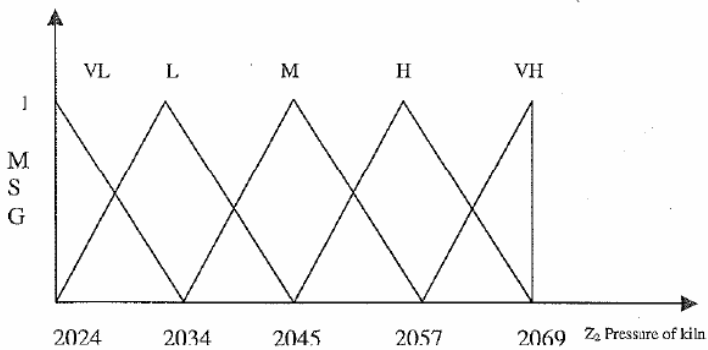




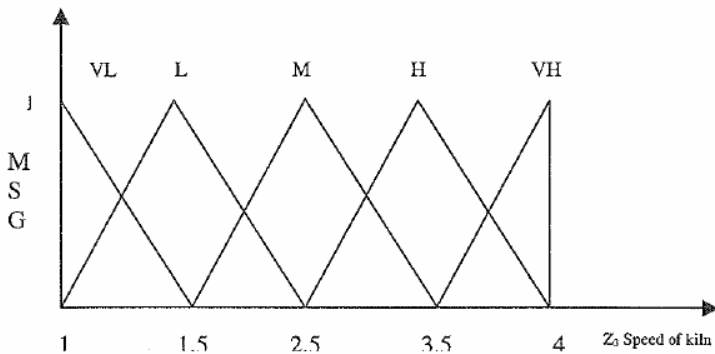
**Figure 5.7: Concentration of NO<sub>x</sub> output parameter**



**Figure 5.8: Pressure of Kiln output parameter**



**Figure 5.9: Speed of Kiln - output parameter**



For the terms of the kiln feed, coal feed, concentration of SO<sub>x</sub>, concentration of NO<sub>x</sub>, pressure of kiln and speed of kiln, the following membership functions are given.

$$\mu_{\text{kiln feed}}(X) = \begin{cases} \mu_{\text{LK}}(X) = (196 - X)/24 & 172 \leq X \leq 196 \\ \mu_{\text{MK}}(X) = \begin{cases} (X - 172)/24 & 172 \leq X \leq 196 \\ (220 - X)/24 & 196 \leq X \leq 220 \end{cases} \\ \mu_{\text{HK}}(X) = (X - 196)/24 & 196 \leq X \leq 220 \end{cases}$$

$$\mu_{\text{Coal feed}}(Y) = \begin{cases} \mu_{\text{LC}}(Y) = (12.13 - Y)/3.57 & 8.56 \leq Y \leq 12.13 \\ \mu_{\text{MC}}(Y) = \begin{cases} (Y - 8.56)/3.57 & 8.56 \leq Y \leq 12.13 \\ (15.70 - Y)/3.57 & 12.13 \leq Y \leq 15.70 \end{cases} \\ \mu_{\text{HC}}(Y) = (Y - 12.13)/3.57 & 12.13 \leq Y \leq 15.70 \end{cases}$$

$$\mu_{\text{ratio of SO}_x \text{ kptc}}(Z) = \begin{cases} \mu_{\text{VL}}(Z) = (.5 - Z)/.3 & .2 \leq Z \leq .5 \\ \mu_{\text{L}}(Z) = \begin{cases} (Z - .2)/.3 & .2 \leq Z \leq .5 \\ (.8 - Z)/.3 & .5 \leq Z \leq .8 \end{cases} \\ \mu_{\text{M}}(Z) = \begin{cases} (Z - .5)/.3 & .5 \leq Z \leq .8 \\ (1.1 - Z)/.3 & .8 \leq Z \leq 1.1 \end{cases} \\ \mu_{\text{H}}(Z) = \begin{cases} (Z - .8)/.3 & .8 \leq Z \leq 1.1 \\ (1.2 - Z)/.1 & 1.1 \leq Z \leq 1.2 \end{cases} \\ \mu_{\text{HC}}(Z) = (Z - 1.1)/.1 & 1.1 \leq Z \leq 1.2 \end{cases}$$

$$\mu_{\text{ratio of NO}_x \text{ kptc}}(Z_1) = \begin{cases} \mu_{\text{VL}}(Z_1) = (1.825 - Z_1)/.425 & 1.4 \leq Z_1 \leq 1.825 \\ \mu_{\text{L}}(Z_1) = \begin{cases} (Z_1 - 1.4)/.425 & 1.4 \leq Z_1 \leq 1.825 \\ (2.25 - Z_1)/.425 & 1.825 \leq Z_1 \leq 2.25 \end{cases} \\ \mu_{\text{M}}(Z_1) = \begin{cases} (Z_1 - 1.825)/.425 & 1.825 \leq Z_1 \leq 2.25 \\ (2.675 - Z_1)/.425 & 2.25 \leq Z_1 \leq 2.675 \end{cases} \\ \mu_{\text{H}}(Z_1) = \begin{cases} (Z_1 - 2.25)/.425 & 2.25 \leq Z_1 \leq 2.675 \\ (3.1 - Z_1)/.425 & 2.675 \leq Z_1 \leq 3.1 \end{cases} \\ \mu_{\text{VH}}(Z_1) = (Z_1 - 2.675)/.425 & 2.675 \leq Z_1 \leq 3.1 \end{cases}$$

$$\mu(Z_2)_{\text{pressure of ki ln}} = \begin{cases} \mu_{\text{VL}}(Z_2) = (2034 - Z_2)/10 & 2024 \leq Z_2 \leq 2034 \\ \mu_{\text{L}}(Z_2) = \begin{cases} (Z_2 - 2024)/10 & 2024 \leq Z_2 \leq 2034 \\ (2045 - Z_2)/11 & 2034 \leq Z_2 \leq 2045 \end{cases} \\ \mu_{\text{M}}(Z_2) = \begin{cases} (Z_2 - 2034)/11 & 2034 \leq Z_2 \leq 2045 \\ (2057 - Z_2)/12 & 2045 \leq Z_2 \leq 2057 \end{cases} \\ \mu_{\text{H}}(Z_2) = \begin{cases} (Z_2 - 2045)/12 & 2045 \leq Z_2 \leq 2057 \\ (2069 - Z_2)/12 & 2057 \leq Z_2 \leq 2069 \end{cases} \\ \mu_{\text{VH}}(Z_2) = (Z_2 - 2057)/12 & 2057 \leq Z_2 \leq 2069 \end{cases}$$

$$\mu(X)_{\text{speed of Ki ln}} = \begin{cases} \mu_{\text{VL}}(Z_3) = (1.5 - Z_3)/.5 & 1 \leq Z_3 \leq 1.5 \\ \mu_{\text{L}}(Z_3) = \begin{cases} (Z_3 - 1)/.5 & 1 \leq Z_3 \leq 1.5 \\ 2.5 - Z_3 & 1.5 \leq Z_3 \leq 2.5 \end{cases} \\ \mu_{\text{M}}(Z_3) = \begin{cases} Z - 1.5 & 1.5 \leq Z_3 \leq 2.5 \\ 3.5 - Z_3 & 2.5 \leq Z_3 \leq 3.5 \end{cases} \\ \mu_{\text{H}}(Z_3) = \begin{cases} Z_3 - 2.5 & 2.5 \leq Z_3 \leq 3.5 \\ 4 - Z_3 / .5 & 3.5 \leq Z_3 \leq 4 \end{cases} \\ \mu_{\text{VH}}(Z_3) = (Z_3 - 3.5)/.5 & 3.5 \leq Z_3 \leq 4 \end{cases}$$

By applying the if ... and ... then rules to the three - membership functions  $\mu(X)$ ,  $\mu(Y)$  and  $\mu(Z)$  we get the following table of rules. The rules given in table 5.1 read as follows:

**Table 5.1: If... and ... then rules for concentration of  $\text{SO}_x$  and  $\text{NO}_x$**

<b>Y</b> <b>x</b>	LC	MC	HC
LK	VL	M	H
MK	L	M	H
HK	M	H	VH

If kiln feed is LK and coal feed is LC then concentration of  $\text{SO}_x$  is VL

If kiln feed is LK and coal feed is MC then concentration of SO<sub>x</sub> is M

If kiln feed is LK and coal feed is HC then concentration of SO<sub>x</sub> is H

If kiln feed is MK and coal feed is LC then concentration of SO<sub>x</sub> is L

If kiln feed is MK and coal feed is MC then concentration of SO<sub>x</sub> is M

If kiln feed is MK and coal feed is HC then concentration of SO<sub>x</sub> is H

If kiln feed is HK and coal feed is LC then concentration of SO<sub>x</sub> is M

If kiln feed is HK and coal feed is MC then concentration of SO<sub>x</sub> is H

If kiln feed is HK and coal feed is HC then concentration of SO<sub>x</sub> is VH

By applying the rules of evaluation using the membership functions defined by the equations if kiln feed is 180 tph and coal feed is 9.75 tph the fuzzy inputs are obtained as  $\mu_{LK}(180) = 0.67$ ,  $\mu_{MK}(180) = 0.33$ ,  $\mu_{LC}(9.75) = 0.67$  and  $\mu_{MC}(9.75) = 0.33$ . Induced decision table for concentration of SO<sub>x</sub> is as follows. Table 5.2: Induced decision table for concentration of SO<sub>x</sub> is as follows.

**Table 5.2: Induced decision table for concentration of SO<sub>x</sub>**

Y X	$\mu_{LC}(9.75) = 0.67$	$\mu_{MC}(9.75) = 0.33$	0
$\mu_{LK}(180) = 0.67$	$\mu_{VL}(Z)$	$\mu_{MK}(Z)$	0
$\mu_{MK}(180) = 0.33$	$\mu_L(Z)$	$\mu_M(Z)$	0
0	0	0	0

Conflict resolutions of the four rules are as follows:

Rule 1: If X is LK and Y is LC then Z is VL

Rule 2: If X is LK and Y is MC then Z is M

Rule 3: If X is MK and Y is LC then Z is L

Rule 4: If X is MK and Y is MC then Z is M

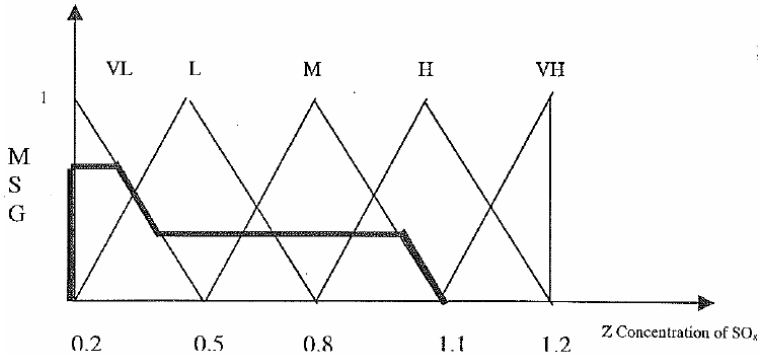
Now, using Table 5.2 the strength values of the four rules are calculated as 0.67, 0.33, 0.33 and 0.33. Control outputs for the concentration of  $SO_x$  are given in Table 5.3.

**Table 5.3: Control outputs for the concentration of  $SO_x$**

Y X	$\mu_{LC}(9.75) = 0.67$	$\mu_{MC}(9.75) = 0.33$	0
$\mu_{LK}(180) = 0.67$	$\min[0.67, \mu_{VL}(Z)]$	$\min[0.33, \mu_M(Z)]$	0
$\mu_{MK}(180) = 0.33$	$\min[0.33, \mu_L(Z)]$	$\min[0.33, \mu_M(Z)]$	0
0	0	0	0

To aggregate (agg) of the control outputs, the maximum of the minimum is obtained. This is given by the following figure 5.10, that is  $\mu_{agg}(Z) = \max\{\min[0.67, \mu_{VL}(Z)], \min[(0.33, \mu_M(Z))], \min[0.33, \mu_L(Z)]\}$ . By applying the mean of maximum method for defuzzification, the intersection points of the line ( $\mu = 0.67$  with the triangular fuzzy number  $\mu_{VL}(Z)$  in equation (5.3), the crisp output is obtained as 0.3 kilogram per ton of clinker.

**Figure 5.10: Aggregated output and defuzzification for the concentration of  $SO_x$**



Now we calculate the concentration of  $NO_x$  to the same kiln feed that is 180 tph and coal feed is 9.75 tph the fuzzy inputs are

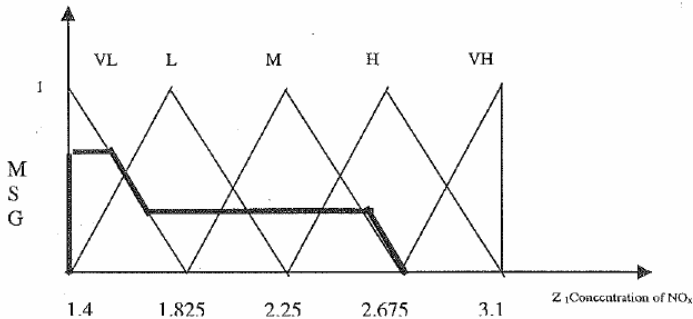
obtained as  $\mu_{LK}(180) = 0.67$ ,  $\mu_{MK}(180) = 0.33$ ,  $\mu_{LC}(9.75) = 0.67$  and  $\mu_{MC}(9.75) = 0.33$ . Using table 5.2 the strength values of the four rules are calculated as 0.67, 0.33, 0.33 and 0.33. Control outputs for the concentration of  $NO_x$  are given in table 5.4.

**Table 5.4: Control outputs for the concentration of  $NO_x$**

Y X	$\mu_{LC}(9.75) = 0.67$	$\mu_{MC}(9.75) = 0.33$	0
$\mu_{LK}(180) = 0.67$	$\min[0.67, \mu_{VL}(Z_1)]$	$\min[0.33, \mu_M(Z_1)]$	0
$\mu_{MK}(180) = 0.33$	$\min[0.33, \mu_L(Z_1)]$	$\min[0.33, \mu_M(Z_1)]$	0
0	0	0	0

To aggregate of the control outputs, the maximum of the minimum is obtained. This is given by the following figure 5.11, that is  $\mu_{agg}(Z_1) = \max\{\min[0.67, \mu_{VL}(Z_1)], \min[(0.33, \mu_M(Z_1))], \min[0.33, \mu_{XL}(Z_1)]\}$ . By applying the mean of maximum method for defuzzification, the intersection points of the line  $\mu = 0.67$  with the triangular fuzzy number  $\mu_{VL}(Z_1)$  in the given equation the crisp output is obtained as 1.54 kilogram per ton of clinker.

**Figure 5.11: Aggregated output and defuzzification for the concentration of  $NO_x$**



Now we calculate the pressure of kiln to the same kiln feed, 180 tph and coal feed is 9.75 tph the fuzzy inputs are obtained as  $\mu_{LK}(180) = 0.67$ ,  $\mu_{MK}(180) = 0.33$ ,  $\mu_{LC}(9.75) = 0.67$  and  $\mu_{MC}(9.75) =$

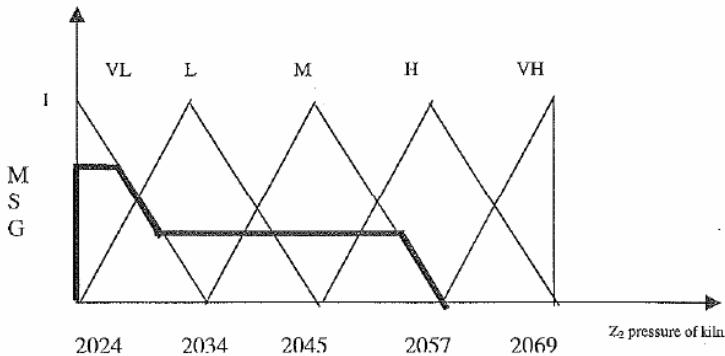
0.33. Using table 5.2 the strength values of the four rules are calculated as 0.67, 0.33, 0.33 and 0.33. Control outputs for the pressure of kiln are given in table 5.5.

**Table 5.5: Control outputs for pressure of kiln**

Y X	$\mu_{LC}(9.75) = 0.67$ $\mu_{MC}(9.75) = 0.33$		0
$\mu_{LK}(180) = 0.67$	$\min[0.67, \mu_{VL}(Z_2)]$	$\min[0.33, \mu_M(Z_2)]$	0
$\mu_{MK}(180) = 0.33$	$\min[0.33, \mu_L(Z_2)]$	$\min[0.33, \mu_M(Z_2)]$	0
0	0	0	0

To aggregate of the control outputs, the maximum of the minimum is obtained. This is given by the following figure 5.12, that is  $\mu_{agg}(Z_2) = \max \{ \min[0.67, \mu_{VL}(Z_2)], \min[0.33, \mu_M(Z_2)], \min[0.33, \mu_L(Z_2)] \}$ . By applying the mean of maximum method for defuzzification, the intersection points of the line  $\mu = 0.67$  with the triangular fuzzy number  $\mu_{VL}(Z_2)$  given by the equation, the crisp output is obtained as 2027.3 mmwg.

**Figure 5.12: Aggregated output and defuzzification for the pressure of kiln**



Now we calculate the speed of kiln to the same kiln feed is 180 tph and coal feed is 9.75 tph, the fuzzy inputs are obtained as  $\mu_{LK}(180) = 0.67$ ,  $\mu_{MK}(180) = 0.33$ ,  $\mu_{LC}(9.75) = 0.67$  and  $\mu_{MC}(9.75) = 0.33$ . Using table 5.2 we calculate the strength values

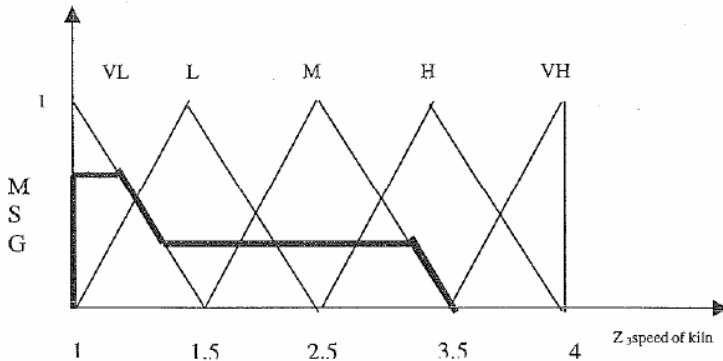
of the four rules as 0.67, 0.33, 0.33 and 0.33. Control outputs for the speed of kiln are given in table 5.6.

**Table 5.6: Control outputs for the speed of kiln**

Y X	$\mu_{LC}(9.75) = 0.67$	$\mu_{MC}(9.75) = 0.33$	0
$\mu_{LK}(180) = 0.67$	$\min[0.67, \mu_{VL}(Z_3)]$	$\min[0.33, \mu_M(Z_3)]$	0
$\mu_{MK}(180) = 0.33$	$\min[0.33, \mu_L(Z_3)]$	$\min[0.33, \mu_M(Z_3)]$	0
0	0	0	0

To aggregate of the control outputs, the maximum of the minimum is obtained. This is given by the following figure 5.13, that is  $\mu_{agg}(Z_3) = \max\{\min[0.67, \mu_{VL}(Z_3)], \min[0.33, \mu_M(Z_3)], \min[0.33, \mu_L(Z_3)]\}$ . By applying the mean of maximum method for defuzzification, the intersection points of the line  $\mu = 0.67$  with the triangular fuzzy number  $\mu_{VL}(Z_3)$  in the equation gives the crisp output is obtained as 1.165 rpm.

**Figure 5.13: Aggregated output and defuzzification for the speed of kiln**



From the study, the following results are derived. The unabsorbed  $SO_x$  emission is calculated to be 0.3 kilogram per ton of clinker and  $NO_x$  to be 1.54 kilogram per ton of clinker from the kiln, when the kiln feed is 180 ton per hour and coal



feed is 9.75 ton per hour using fuzzy control. To reduce the unabsorbed  $\text{SO}_x$  and  $\text{NO}_x$  we took the speed of the kiln as 1.17 rpm and pressure of the kiln as 2027.3 mmwg for proper mix of  $\text{SO}_x$  and  $\text{NO}_x$  in the kiln using fuzzy control.

By applying the rules of evaluation using the membership functions defined by the equations if kiln feed is 200 tph and coal feed is 12.15 tph the fuzzy inputs are obtained as  $\mu_{\text{MK}}(200) = 0.83$ ,  $\mu_{\text{HK}}(200) = 0.16$ ,  $\mu_{\text{MC}}(12.15) = 0.99$  and  $\mu_{\text{HC}}(12.15) = 0.006$ . Induced decision table for concentration of  $\text{SO}_x$  is as follows.

**Table 5.7: Induced decision table for concentration of  $\text{SO}_x$**

Y X	0	$\mu_{\text{LC}}(12.15) = 0.99$	$\mu_{\text{MC}}(12.75) = 0.006$
0	0	0	0
$\mu_{\text{LK}}(200) = 0.83$	0	$\mu_{\text{M}}(\text{Z})$	$\mu_{\text{H}}(\text{Z})$
$\mu_{\text{HK}}(200) = 0.16$	0	$\mu_{\text{H}}(\text{Z})$	$\mu_{\text{VH}}(\text{Z})$

Conflict resolutions of the four rules is as follows:

- Rule 1: If X is MK and Y is MC then Z is M
- Rule 2: If X is MK and Y is HC then Z is H
- Rule 3: If X is HK and Y is MC then Z is H
- Rule 4: If X is HK and Y is HC then Z is VH.

Now, using table 5.7 the strength values of the four rules are calculated as 0.83, 0.006, 0.16 and 0.006. Control outputs for the concentration of  $\text{SO}_x$  are given in the following table 5.8.

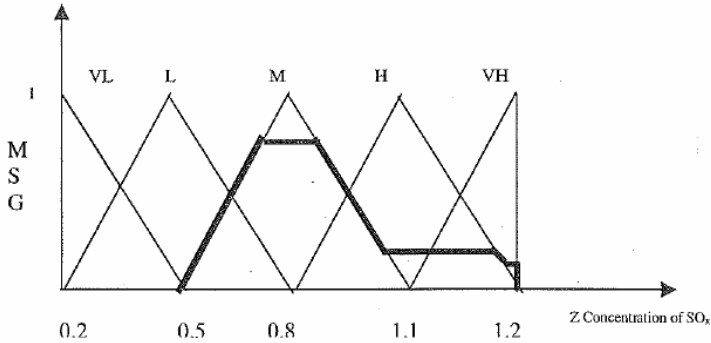
**Table 5.8: Control outputs for the concentration of  $\text{SO}_x$**

Y X	0	$\mu_{\text{LC}}(12.15) = 0.99$	$\mu_{\text{MC}}(12.75) = 0.006$
0	0	0	0
$\mu_{\text{LK}}(200) = 0.83$	0	$\min[0.83, \mu_{\text{M}}(\text{Z})]$	$\min[0.006, \mu_{\text{H}}(\text{Z})]$
$\mu_{\text{HK}}(200) = 0.16$	0	$\min[0.16, \mu_{\text{H}}(\text{Z})]$	$\min[0.006, \mu_{\text{VH}}(\text{Z})]$

To aggregate of the control outputs, the maximum of the

minimum is obtained. This is given by the following figure 5.14, that is  $\mu_{agg}(Z) = \max\{\min[0.83, \mu_M(Z)], \min[0.16, \mu_H(Z)], \min[0.006, \mu_H(Z)]\}$ . By applying the mean of maximum method for defuzzification, the intersection point of the line  $\mu = 0.83$  with the triangular fuzzy number  $\mu_M(Z)$  in the equation gives the crisp output is obtained as 0.8 kilogram per ton of clinker.

**Figure 5.14: Aggregated output and defuzzification for the concentration of  $SO_x$**



Now we calculate the concentration of  $NO_x$  to the same kiln feed 200 tph and coal feed is 12.15 tph the fuzzy inputs are obtained as  $\mu_{MK}(200) = 0.83$ ,  $\mu_{HK}(200) = 0.16$ ,  $\mu_{MC}(12.15) = 0.99$  and  $\mu_{HC}(12.15) = 0.006$ . Using Table 5.7 the strength values of the four rules are calculated as 0.83, 0.006, 0.16 and 0.006. Control outputs for the concentration of  $NO_x$  are given in table 5.9.

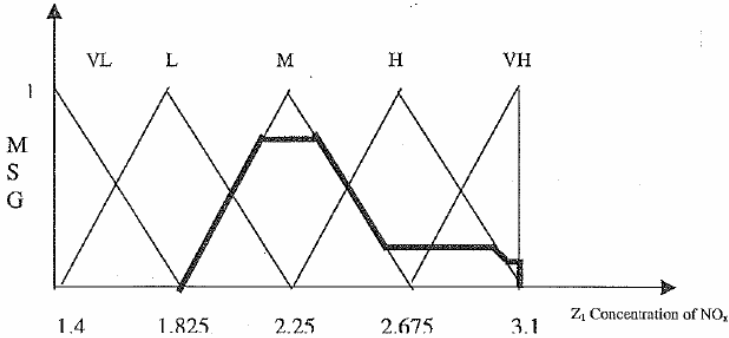
**Table 5.9: Control outputs for the concentration of  $NO_x$**

Y X	0	$\mu_{MC}(12.15) = 0.99$	$\mu_{HC}(12.75) = 0.006$
0	0	0	0
$\mu_{MK}(200) = 0.83$	0	$\min[0.83, \mu_M(Z_1)]$	$\min[0.006, \mu_H(Z_1)]$
$\mu_{HK}(200) = 0.16$	0	$\min[0.16, \mu_H(Z_1)]$	$\min[0.006, \mu_{VH}(Z_1)]$

To aggregate of the control outputs, the maximum of the minimum is obtained. This is given by the following figure 5.15,

that is  $\mu_{agg}(Z_1) = \max\{\min[0.83, \mu_M(Z_1)], \min[0.16, \mu_H(Z_1)], \min[0.006, \mu_{VH}(Z_1)]\}$ . By applying the mean of maximum method for defuzzification the intersection points of the line  $\mu = 0.83$  with the triangular fuzzy number  $\mu_M(Z_1)$  in the equation gives the crisp output to be 2.25 kilogram per ton of clinker.

**Figure 5.15: Aggregated output and defuzzification for the concentration of NO<sub>x</sub>**



Now we calculate the pressure of kiln to the same kiln feed, 200 tph and coal feed is 12.15 tph the fuzzy inputs are obtained as  $\mu_{MK}(200) = 0.83$ ,  $\mu_{HK}(200) = 0.16$ ,  $\mu_{MC}(12.15) = 0.99$  and  $\mu_{HC}(12.15) = 0.006$ . Using table 5.7 the strength values of the four rules are calculated as 0.83, 0.006, 0.16 and 0.006. Control outputs for the pressure of kiln are given in table 5.10.

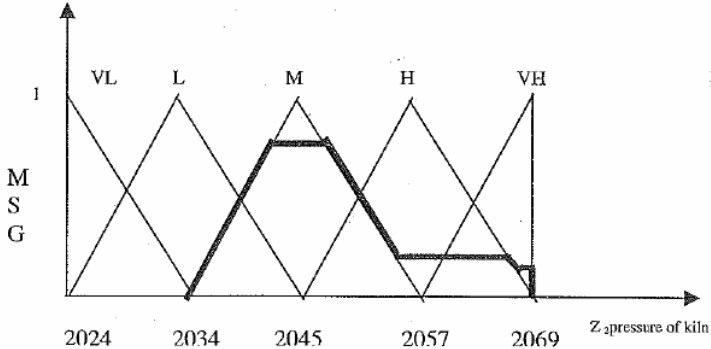
**Table 5.10: Control outputs for the pressure of kiln**

Y X	0	$\mu_{MC}(12.15) = 0.99$	$\mu_{HC}(12.75) = 0.006$
0	0	0	0
$\mu_{MK}(200) = 0.83$	0	$\min[0.83, \mu_M(Z_2)]$	$\min[0.006, \mu_H(Z_2)]$
$\mu_{HK}(200) = 0.16$	0	$\min[0.16, \mu_H(Z_2)]$	$\min[0.006, \mu_{VH}(Z_2)]$

To aggregate of the control outputs, the maximum of the minimum is obtained. This is given by the following figure 5.16, that is  $\mu_{agg}(Z_2) = \max\{\min[0.83, \mu_M(Z_2)], \min[0.16, \mu_H(Z_2)], \min[0.006, \mu_{VH}(Z_2)]\}$ . By applying the mean of maximum

method for defuzzification, the intersection points of the line  $\mu = 0.83$  with the triangular fuzzy number  $\mu_M(Z_2)$  in the equation gives the crisp output is obtained as 2045 mmwg.

**Figure 5.16: Aggregated output and defuzzification for the pressure of kiln**



Now we calculate the speed of kiln to the same kiln feed, 200 tph and coal feed is 12.15 tph the fuzzy inputs are obtained as  $\mu_{MK}(200) = 0.83$ ,  $\mu_{HK}(200) = 0.16$ ,  $\mu_{MC}(12.15) = 0.99$  and  $\mu_{HC}(12.15) = 0.006$ . Using table 5.7 we calculate the strength values of the four rules as 0.83, 0.006, 0.16 and 0.006. Control outputs for the speed of kiln are given in table 5.11.

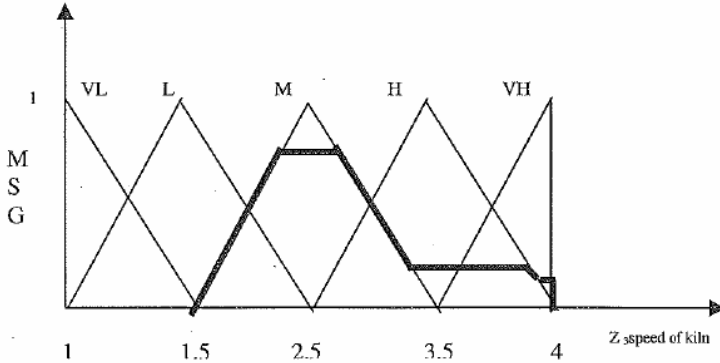
**Table 5.11: Control outputs for the speed of kiln**

Y X	0	$\mu_{MC}(12.15) = 0.99$	$\mu_{HC}(12.75) = 0.006$
0	0	0	0
$\mu_{MK}(200) = 0.83$	0	$\min[0.83, \mu_M(Z_3)]$	$\min[0.006, \mu_H(Z_3)]$
$\mu_{HK}(200) = 0.16$	0	$\min[0.16, \mu_H(Z_3)]$	$\min[0.006, \mu_{VH}(Z_3)]$

To aggregate of the control outputs, the maximum of the minimum is obtained. This is given by the following Figure 5.17, that is  $\mu_{agg}(Z_3) = \max \{ \min[0.83, \mu_M(Z_3)], \min[0.16, \mu_H(Z_3)], \min[0.006, \mu_{VH}(Z_3)] \}$ . By applying the mean of maximum method for defuzzification, the intersection points of the line  $\mu = 0.83$

with the triangular fuzzy number  $\mu_M(Z_3)$  in the equation gives the crisp output is obtained as 2.5 rpm.

**Figure 5.17: Aggregated output and defuzzification for the speed of kiln**



From the study, the following results are derived. The unabsorbed  $SO_x$  emission to be 0.8 kilogram per ton of clinker and  $NO_x$  to be 2.25 kilogram per ton of clinker from kiln, when the kiln feed is 200 ton per hour and coal feed is 12.15 ton per hour using fuzzy control. To reduce the unabsorbed  $SO_x$  and  $NO_x$  we took the speed of kiln as 2.5 rpm and pressure of kiln as 2045 mmwg for proper mix of  $SO_x$  and  $NO_x$  in kiln using fuzzy control.

By applying the rules of evaluation using the membership functions defined by the equation (5.1) and (5.2), if kiln feed is 172 tph and coal feed is 8.60 tph the fuzzy inputs are obtained as  $\mu_{LK}(172) = 1$ ,  $\mu_{MK}(172) = 0$ ,  $\mu_{LC}(8.60) = 0.98$  and  $\mu_{MC}(8.60) = 0.011$ . Induced decision table for concentration of  $SO_x$  is as follows.

**Table 5.12: Induced decision table for concentration of  $SO_x$**

Y X	$\mu_{LC}(8.60) = 0.98$ $\mu_{MC}(8.60) = 0.011$ 0		
$\mu_{LK}(172) = 1$	$\mu_{VL}(Z)$	$\mu_M(Z)$	0
$\mu_{MK}(172) = 0$	$\mu_L(Z)$	$\mu_M(Z)$	0
0	0	0	0

Conflict resolutions of the four rules are as follows:

Rule 1: If X is LK and Y is LC then Z is VL

Rule 2: If X is LK and Y is MC then Z is M

Rule 3: If X is MK and Y is LC then Z is L

Rule 4: If X is MK and Y is MC then Z is M.

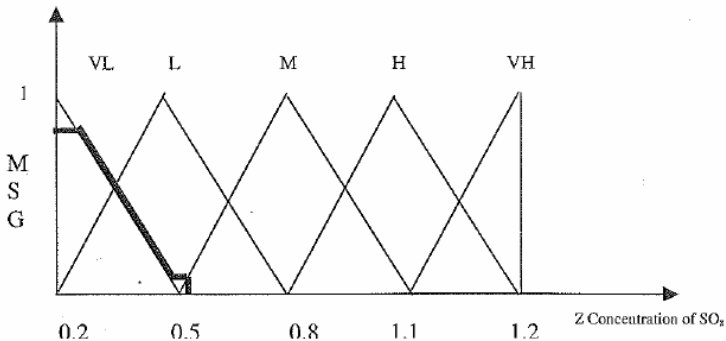
Now, using table 5.12 the strength values of the four rules are calculated as 0.98, 0.011, 0, 0. Control outputs for the concentration of  $SO_x$  are given in table 5.13.

**Table 5.13: Control outputs for the concentration of  $SO_x$**

Y X	$\mu_{LC}(8.60) = 0.98$	$\mu_{MC}(8.60) = 0.011$	0
$\mu_{LK}(172) = 1$	$\min[0.98, \mu_{VL}(Z)]$	$\min[0.011, \mu_M(Z)]$	0
$\mu_{MK}(172) = 0$	$\min[0, \mu_L(Z)]$	$\min[0, \mu_M(Z)]$	0
0	0	0	0

To aggregate (agg) of the control outputs, the maximum of the minimum is obtained. This is given by the following figure 5.18, that is  $\mu_{agg}(Z) = \max\{\min[0.98, \mu_{VL}(Z)], \min[0.011, \mu_M(Z)], \min[0, \mu_L(Z)]\}$ . By applying the mean of maximum method for defuzzification, the intersection point of the line  $\mu = 0.98$  with the triangular fuzzy number  $\mu_{VL}(Z)$  in the equation gives the crisp output is obtained as 0.21 kilogram per ton of clinker.

**Figure 5.18: Aggregated output and defuzzification for the concentration of  $SO_x$ ,**



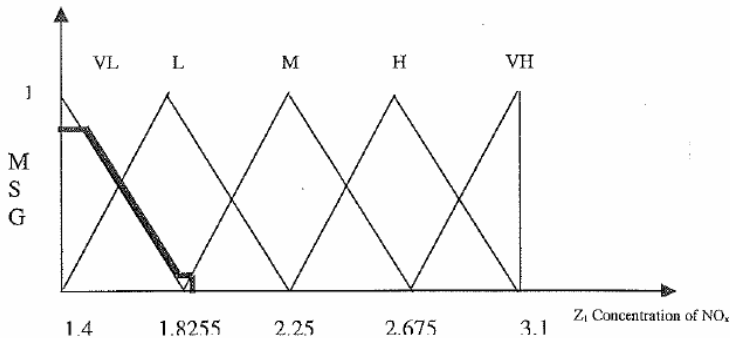
Now we calculate the concentration of  $\text{NO}_x$  to the same kiln feed, 172 tph and coal feed is 8.60 tph the fuzzy inputs are obtained as  $\mu_{LK}(172) = 1$ ,  $\mu_{MK}(172) = 0$ ,  $\mu_{LC}(8.60) = 0.98$  and  $\mu_{MC}(8.60) = 0.011$ . Using table 5.12 the strength values of the four rules are calculated as 0.98, 0.011, 0, 0. Control outputs for the concentration of  $\text{NO}_x$  are given in table 5.14.

**Table 5.14: Control outputs for the concentration of  $\text{NO}_x$**

Y X	$\mu_{LC}(8.60) = 0.98$	$\mu_{MC}(8.60) = 0.011$	0
$\mu_{LK}(172) = 1$	$\min[0.98, \mu_{VL}(Z_1)]$	$\min[0.011, \mu_M(Z_1)]$	0
$\mu_{MK}(172) = 0$	$\min[0, \mu_L(Z_1)]$	$\min[0, \mu_M(Z_1)]$	0
0	0	0	0

To aggregate of the control outputs, the maximum of the minimum is obtained. This is given by the following Figure 5.19, that is  $\mu_{agg}(Z_1) = \max\{\min[0.98, \mu_{VL}(Z_1)], \min[0.011, \mu_M(Z_1)], \min[0, \mu_L(Z_1)]\}$ . By applying the mean of maximum method for defuzzification, the intersection point of the line  $\mu = 0.98$  with the triangular fuzzy number  $\mu_{VL}(Z_1)$  in the equation gives the crisp output is obtained as 1.4085 kilogram per ton of clinker.

**Figure 5.19: Aggregated output and defuzzification for the concentration of  $\text{NO}_x$**



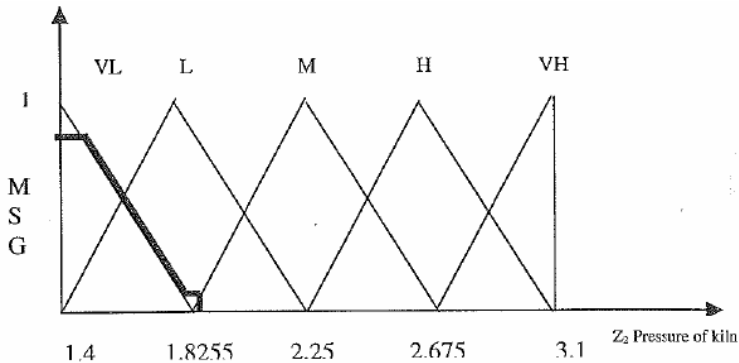
Now we calculate the pressure of kiln to the same kiln feed, 172 tph and coal feed is 8.60 tph the fuzzy inputs are obtained as  $\mu_{LK}(172) = 1$ ,  $\mu_{MK}(172) = 0$ ,  $\mu_{LC}(8.60) = 0.98$  and  $\mu_{MC}(8.60) = 0.011$ . Using Table 5.12 the strength values of the four rules are calculated as 0.98, 0.011, 0, 0. Control outputs for the pressure of kiln is given in Table 5.15.

**Table 5.15: Control outputs for the pressure of Kiln**

Y X	$\mu_{LC}(8.60) = 0.98$	$\mu_{MC}(8.60) = 0.011$	0
$\mu_{LK}(172) = 1$	$\min[0.98, \mu_{VL}(Z_2)]$	$\min[0.011, \mu_M(Z_2)]$	0
$\mu_{MK}(172) = 0$	$\min[0, \mu_L(Z_2)]$	$\min[0, \mu_M(Z_2)]$	0
0	0	0	0

To aggregate of the control outputs, we obtain the maximum of the minimum. This is given by the following Figure 5.20, that is  $\mu_{agg}(Z_2) = \max\{\min[0.98, \mu_{VL}(Z_2)], \min[0.011, \mu_M(Z_2)], \min[0, \mu_L(Z_2)]\}$ . By applying the mean of maximum method for defuzzification, the intersection point of the line  $\mu = 0.98$  with the triangular fuzzy number  $\mu_{VL}(Z_2)$  in the equation gives and get the crisp output is obtained as 2024.2 mmwg.

**Figure 5.20: Aggregated output and defuzzification for the pressure of kiln**





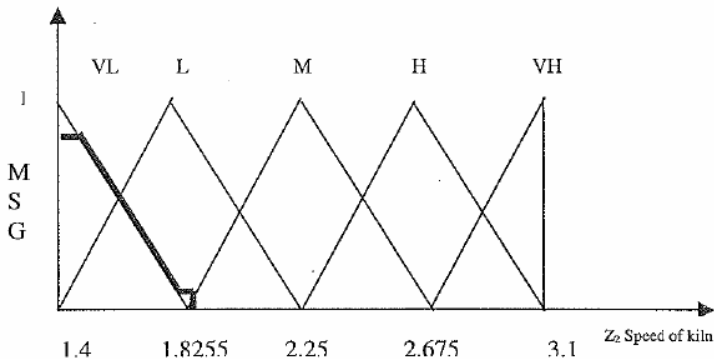
Now we calculate the speed of kiln to the same kiln feed, 172 tph and coal feed is 8.60 tph the fuzzy inputs are obtained as  $\mu_{LK}(172) = 1$ ,  $\mu_{MK}(172) = 0$ ,  $\mu_{LC}(8.60) = 0.98$  and  $\mu_{MC}(8.60) = 0.011$ . Using Table 5.12 the strength values of the four rules are calculated as 0.98, 0.011, 0, 0. Control outputs for the speed of kiln is given in Table 5.16.

**Table 5.16: Control outputs for the speed of Kiln**

Y X	$\mu_{LC}(8.60) = 0.98$	$\mu_{MC}(8.60) = 0.011$	0
$\mu_{LK}(172) = 1$	$\min[0.98, \mu_{VL}(Z_3)]$	$\min[0.011, \mu_M(Z_3)]$	0
$\mu_{MK}(172) = 0$	$\min[0, \mu_L(Z_3)]$	$\min[0, \mu_M(Z_3)]$	0
0	0	0	0

To aggregate of the control outputs, we obtain the maximum of the minimum. This is given by the following Figure 5.21, that is  $\mu_{agg}(Z_3) = \max\{\min[0.98, \mu_{VL}(Z_3)], \min[0.011, \mu_M(Z_3)], \min[0, \mu_L(Z_3)]\}$ . By applying the mean of maximum method for defuzzification, the intersection point of the line  $\mu = 0.98$  with the triangular fuzzy number  $\mu_{VL}(Z_3)$  in the equation gives the crisp output is obtained as 1.01 rpm.

**Figure 5.21: Aggregated output and defuzzification for the speed of kiln**



From the study, the following results are derived. The unabsorbed  $SO_x$  emission to be 0.21 kilogram per ton of clinker

and  $\text{NO}_x$  to be 1.4085 kilogram per ton of clinker from kiln, when the kiln feed is 172 ton per hour and coal feed is 8.60 ton per hour using fuzzy control. To reduce the unabsorbed  $\text{SO}_x$  and  $\text{NO}_x$  we took the speed of kiln as 1.01 rpm and pressure of kiln as 2024.2 mmwg for proper mix of  $\text{SO}_x$  and  $\text{NO}_x$  in kiln using fuzzy control.

By applying the rules of evaluation using the membership functions defined by the equation (5.1) and (5.2), if kiln feed is 220 tph and coal feed is 14.5 tph the fuzzy inputs are obtained as  $\mu_{\text{MK}}(220) = 0$ ,  $\mu_{\text{HK}}(220) = 1$ ,  $\mu_{\text{MC}}(14.5) = 0.34$  and  $\mu_{\text{HC}}(14.5) = 0.66$ . Induced decision table for concentration of  $\text{SO}_x$  is as follows.

**Table 5.17: Induced decision table for concentration of  $\text{SO}_x$**

Y X	0	$\mu_{\text{MC}}(14.15) = 0.34$	$\mu_{\text{HC}}(14.75) = 0.66$
0	0	0	0
$\mu_{\text{MK}}(220) = 0$	0	$\mu_{\text{M}}(Z)$	$\mu_{\text{H}}(Z)$
$\mu_{\text{HK}}(220) = 1$	0	$\mu_{\text{H}}(Z)$	$\mu_{\text{VH}}(Z)$

Conflict resolutions of the four rules are as follows:

Rule 1: If X is MK and Y is MC then Z is M

Rule 2: If X is MK and Y is HC then Z is H

Rule 3: If X is HK and Y is MC then Z is H

Rule 4: If X is HK and Y is HC then Z is VH.

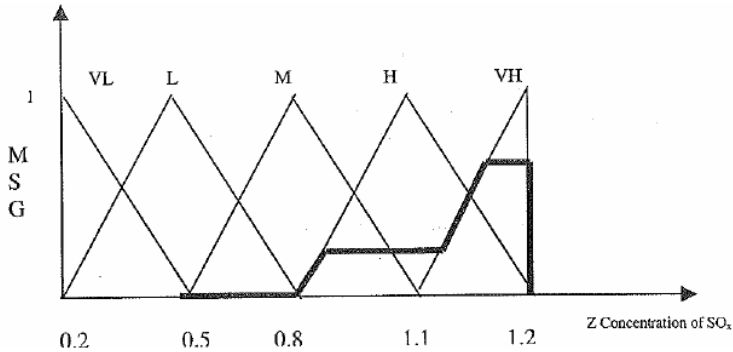
Now, using Table 5.17 the strength values of the four rules are calculated as 0, 0, 0.34, 0.66. Control outputs for the concentration of  $\text{SO}_x$  are given in table 5.18.

**Table 5.18: Control outputs for the concentration of  $\text{SO}_x$**

Y X	0	$\mu_{\text{MC}}(14.15) = 0.34$	$\mu_{\text{MC}}(14.75) = 0.66$
0	0	0	0
$\mu_{\text{MK}}(220) = 0$	0	$\min[0, \mu_{\text{M}}(Z)]$	$\min[0, \mu_{\text{H}}(Z)]$
$\mu_{\text{HK}}(220) = 1$	0	$\min[0.34, \mu_{\text{H}}(Z)]$	$\min[0.66, \mu_{\text{VH}}(Z)]$

To aggregate of the control outputs, the maximum of the minimum is obtained. This is given by the following figure 5.22, that is  $u_{agg}(Z) = \max \{ \min[0, \mu_M(Z)], \min[0.34, \mu_H(Z)], \min[0.66, \mu_{VH}(Z)] \}$ . By applying the mean of maximum method for defuzzification, the intersection point of the line  $\mu = 0.66$  with the triangular fuzzy number  $\mu_{VH}(Z)$  in the equation gives the crisp output is obtained as 1.166 kilogram per ton of clinker.

**Figure 5.22: Aggregated output and defuzzification for the concentration of  $SO_x$**



Now we calculate the concentration of  $NO_x$  to the same kiln feed, 220 tph and coal feed is 14.5 tph the fuzzy inputs are obtained as  $\mu_{MK}(220) = 0$ ,  $\mu_{HK}(220) = 1$ ,  $\mu_{MC}(14.5) = 0.34$  and  $\mu_{HC}(14.5) = 0.66$ . Using Table 5.17 the strength values of the four rules are calculated as 0, 0, 0.34, 0.66. Control outputs for the concentration of  $NO_x$  are given in table 5.19.

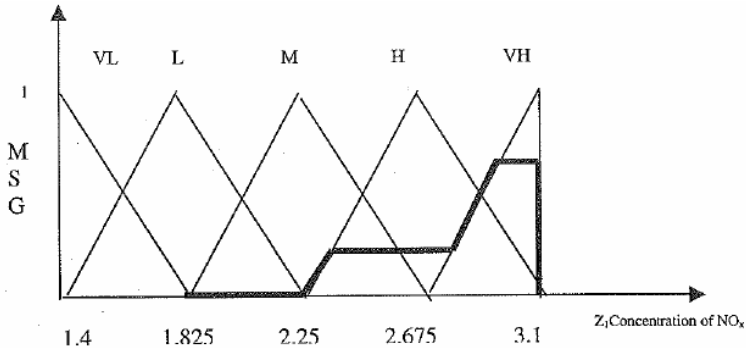
**Table 5.19: Control outputs for the concentration of  $NO_x$**

Y / X	0	$\mu_{MC}(14.15) = 0.34$	$\mu_{MC}(14.75) = 0.66$
0	0	0	0
$\mu_{MK}(220) = 0$	0	$\min[0, \mu_M(Z_1)]$	$\min[0, \mu_H(Z_1)]$
$\mu_{HK}(220) = 1$	0	$\min[0.34, \mu_H(Z_1)]$	$\min[0.66, \mu_{VH}(Z_1)]$

To aggregate of the control outputs, the maximum of the minimum is obtained. This is given by the following figure

5.23, that is  $\mu_{agg}(Z_1) = \max \{ \min[0, \mu_M(Z_1)] \min[0.34, \mu_H(Z_1)] \min[0.66, \mu_{VH}(Z_1)] \}$ . By applying the mean of maximum method for defuzzification, the intersection point of the line  $\mu = 0.66$  with the triangular fuzzy number  $\mu_{VH}(Z_1)$  in the equation gives the crisp output is obtained as 2.9555 Kilogram per ton of clinker.

**Figure 5.23: Aggregated output and defuzzification for the concentration of NO<sub>x</sub>**



Now we calculate the pressure of lain to the same kiln feed, 220 tph and coal feed is 14.5 tph the fuzzy inputs are obtained as  $\mu_{MK}(220) = 0$ ,  $\mu_{HK}(220) = 1$ ,  $\mu_{MC}(14.5) = 0.34$  and  $\mu_{HC}(14.5) = 0.66$ . Using Table 5.17 the strength values of the four rules are calculated as 0, 0, 0.34, 0.66. Control outputs for the pressure of kiln are given in table 5.20.

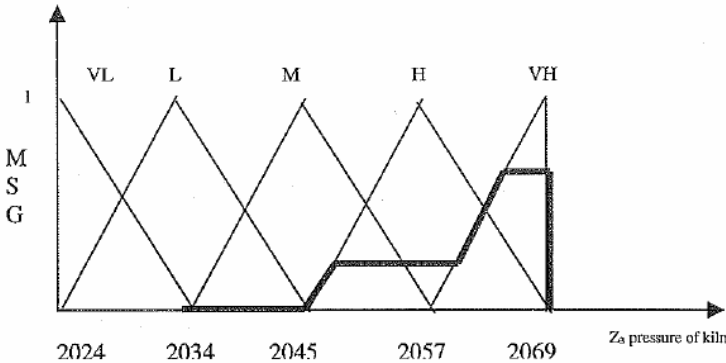
**Table 5.20: Control outputs for the concentration of NO<sub>x</sub>**

Y X	0	$\mu_{MC}(14.15) = 0.34$	$\mu_{MC}(14.75) = 0.66$
0	0	0	0
$\mu_{MK}(220) = 0$	0	$\min[0, \mu_M(Z_2)]$	$\min[0, \mu_H(Z_2)]$
$\mu_{HK}(220) = 1$	0	$\min[0.34, \mu_H(Z_2)]$	$\min[0.66, \mu_{VH}(Z_2)]$

To aggregate of the control outputs, the maximum of the minimum is obtained. This is given by the following Figure 5.24, that is  $\mu_{agg}(Z_2) = \max \{ \min[0, \mu_M(Z_2)], \min[0.34, \mu_H(Z_2)] \min[0.66, \mu_{VH}(Z_2)] \}$ . By applying the mean of maximum method

for defuzzification, the intersection point of the line  $\mu = 0.66$  with the triangular fuzzy number  $\mu_{VH}(Z_2)$  in the equation gives the crisp output is obtained as 2064.92 mmwg.

**Figure 5.24: Aggregated output and defuzzification for the pressure of kiln**



Now we calculate the speed of kiln to the same kiln feed, 220 tph and coal feed is 14.5 tph the fuzzy inputs are calculated as  $\mu_{MK}(220) = 0$ ,  $\mu_{HK}(220) = 1$ ,  $\mu_{MC}(14.5) = 0.34$  and  $\mu_{HC}(14.5) = 0.66$ . Using table 5.17 the strength values of the four rules are calculated as 0, 0, 0.34, 0.66. Control outputs for the speed of kiln are given in table 5.21.

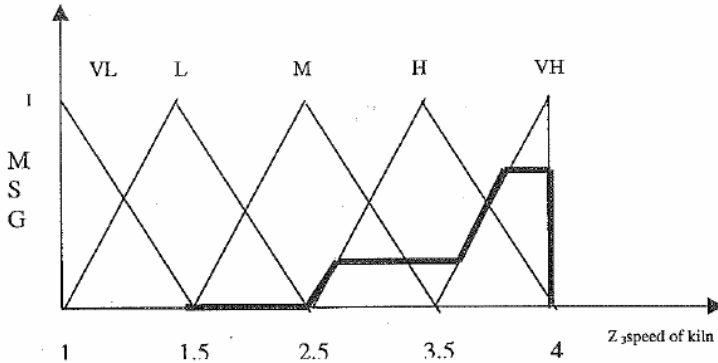
**Table 5.21: Control outputs for the speed of kiln**

Y X	0	$\mu_{MC}(14.5) = 0.34$	$\mu_{HC}(14.5) = 0.66$
0	0	0	0
$\mu_{MK}(220) = 0$	0	$\min[0, \mu_M(Z_3)]$	$\min[0, \mu_H(Z_3)]$
$\mu_{HK}(220) = 1$	0	$\min[0.34, \mu_H(Z_3)]$	$\min[0.66, \mu_{VH}(Z_3)]$

To aggregate of the control outputs, the maximum of the minimum is obtained. This is given by the following figure 5.25, that is  $\mu_{agg}(Z_3) = \max \{ \min[0, \mu_M(Z_3)] \min[0.34, \mu_H(Z_3)] \min[0.66, \mu_{VH}(Z_3)] \}$ . By applying the mean of maximum method for defuzzification, the intersection point of the line  $\mu = 0.66$  with

the triangular fuzzy number  $\mu_{VH}(Z_3)$  in the equation gives the crisp output is obtained as 3.83 rpm.

**Figure 5.25: Aggregated output and defuzzification for the speed of kiln**



From the study, the following results are derived. The unabsorbed  $SO_x$  emission to be 1.166 kilogram per ton of clinker and  $NO_x$  to be 2.9555 kilogram per ton of clinker from kiln, when the kiln feed is 220 ton per hour and coal feed is 14.5 ton per hour using fuzzy control. To reduce the unabsorbed  $SO_x$  and  $NO_x$  we took the speed of kiln as 3.83 rpm and pressure of kiln as 2064.92 mmwg for proper mix of  $SO_x$  and  $NO_x$  in kiln using fuzzy control.

By applying the rules of evaluation using the membership functions defined by the equations (5.1) and (5.2), if kiln feed is 196 tph and coal feed is 11.5 tph the fuzzy inputs are obtained as  $\mu_{LK}(196) = 0$ ,  $\mu_{MK}(196) = 1$ ,  $\mu_{HK}(196) = 0$ ,  $\mu_{LC}(11.5) = 0.18$  and  $\mu_{MC}(11.5) = 0.82$ . Induced decision table for concentration of  $SO_x$  is as follows.

**Table 5.22: Induced decision table for concentration of  $SO_x$**

Y / X	$\mu_{LC}(11.5) = 0.18$	$\mu_{MC}(11.5) = 0.82$	0
$\mu_{LK}(196) = 0$	$\mu_{VL}(Z)$	$\mu_M(Z)$	0
$\mu_{MK}(196) = 1$	$\mu_L(Z)$	$\mu_M(Z)$	0
$\mu_{HK}(196) = 0$	$\mu_M(Z)$	$\mu_H(Z)$	0

Conflict resolutions of the six rules are as follows:

Rule 1: If X is LK and Y is LC then Z is VL

Rule 2: If X is LK and Y is MC then Z is M

Rule 3: If X is MK and Y is LC then Z is L

Rule 4: If X is MK and Y is MC then Z is M.

Rule 5: If X is HK and Y is LC then Z is M

Rule 6: If X is HK and Y is MC then Z is H.

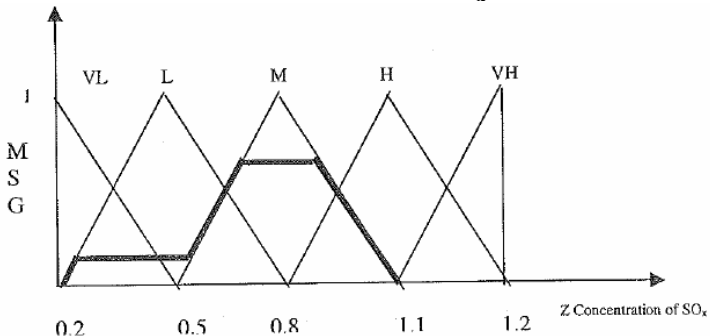
Now, using Table 5.22 the strength values of the six rules are calculated as 0, 0, 0.18, 0.82, 0, 0. Control outputs for the concentration of  $SO_x$  are given in table 5.23.

**Table 5.23: Control outputs for the concentration of  $SO_x$**

Y X	$\mu_{LC}(11.5) = 0.18$	$\mu_{MC}(11.5) = 0.82$	0
$\mu_{LK}(196) = 0$	$\min[0, \mu_{VL}(Z)]$	$\min[0, \mu_M(Z)]$	0
$\mu_{MK}(196) = 1$	$\min[0.18, \mu_L(Z)]$	$\min[0.82, \mu_M(Z)]$	0
$\mu_{HK}(196) = 0$	$\min[0, \mu_M(Z)]$	$\min[0, \mu_H(Z)]$	0

To aggregate of the control outputs, the maximum of the minimum is obtained. This is given by the following figure 5.26, that is  $\mu_{agg}(Z) = \max\{\min[0, \mu_{VL}(Z)], \min[0.18, \mu_L(Z)], \min[0.82, \mu_M(Z)], \min[0, \mu_H(Z)]\}$ . By applying the mean of maximum method for defuzzification, the intersection point of the line  $\mu = 0.82$  with the triangular fuzzy number  $\mu_M(Z)$  in equation (5.3) the crisp output is obtained as 0.8 kilogram per ton of clinker.

**Figure 5.26: Aggregated output and defuzzification for the concentration of  $SO_x$**



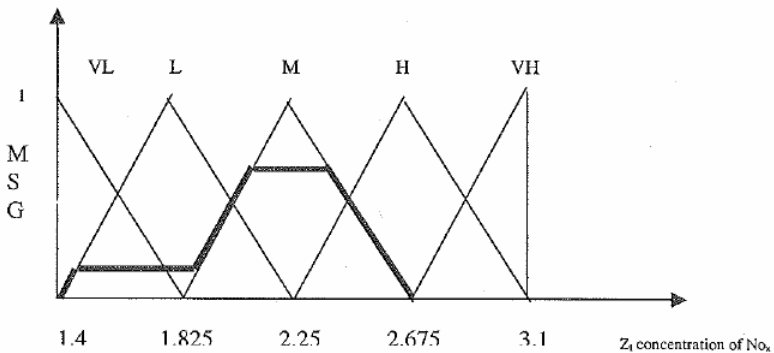
Now we calculate the concentration of  $\text{NO}_x$  to the same kiln feed, 196 tph and coal feed is 11.5 tph the fuzzy inputs are obtained as  $\mu_{LK}(196) = 0$ ,  $\mu_{MK}(196) = 1$ ,  $\mu_{HK}(196) = 0$ ,  $\mu_{LC}(11.5) = 0.18$  and  $\mu_{MC}(11.5) = 0.82$ . Using Table 5.22 the strength values of the six rules are calculated as 0, 0, 0.18, 0.82, 0, 0. Control outputs for the concentration of  $\text{NO}_x$  are given in table 5.24.

**Table 5.24: Control outputs for the concentration of  $\text{NO}_x$**

Y X	$\mu_{LC}(11.5) = 0.18$	$\mu_{MC}(11.5) = 0.82$	0
$\mu_{LK}(196) = 0$	$\min[0, \mu_{VL}(Z_1)]$	$\min[0, \mu_M(Z_1)]$	0
$\mu_{MK}(196) = 1$	$\min[0.18, \mu_L(Z_1)]$	$\min[0.82, \mu_M(Z_1)]$	0
$\mu_{HK}(196) = 0$	$\min[0, \mu_M(Z_1)]$	$\min[0, \mu_H(Z_1)]$	0

To aggregate of the control outputs, the maximum of the minimum is obtained. This is given by the following figure 5.27, that is  $\mu_{agg}(Z_1) = \max\{\min[0, \mu_{VL}(Z_1)], \min[0.18, \mu_L(Z_1)], \min[0.82, \mu_M(Z_1)], \min[0, \mu_H(Z_1)]\}$ . By applying the mean of maximum method for defuzzification, the intersection point of the line  $\{X = 0.82$  with the triangular fuzzy number  $\mu_M(Z_1)$  in equation (5.4) the crisp output is calculated as 2.25 kilogram per ton of clinker.

**Figure 5.27: Aggregated output and defuzzification for the concentration of NO**





Now we calculate the pressure of kiln to the same kiln feed, 196 tph and coal feed is 11.5 tph we get the fuzzy inputs as  $\mu_{LK}(196) = 0$ ,  $\mu_{MK}(196) = 1$ ,  $\mu_{HK}(196) = 0$ ,  $\mu_{LC}(11.5) = 0.18$  and  $\mu_{MC}(11.5) = 0.82$ .

Using table 5.22 the strength values of the six rules are calculated as 0, 0, 0.18, 0.82, 0, 0. Control outputs for the pressure of kiln are given in table 5.25.

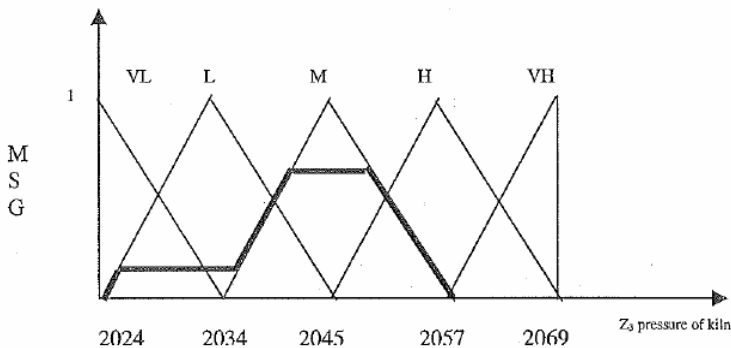
**Table 5.25: Control outputs for the pressure of kiln**

Y X	$\mu_{LC}(11.5) = 0.18$	$\mu_{MC}(11.5) = 0.82$	0
$\mu_{LK}(196) = 0$	$\min[0, \mu_{VL}(Z_2)]$	$\min[0, \mu_M(Z_2)]$	0
$\mu_{MK}(196) = 1$	$\min[0.18, \mu_L(Z_2)]$	$\min[0.82, \mu_M(Z_2)]$	0
$\mu_{HK}(196) = 0$	$\min[0, \mu_M(Z_2)]$	$\min[0, \mu_H(Z_2)]$	0

To aggregate of the control outputs, the maximum of the minimum is obtained. This is given by the following Figure 5.28, that is  $\mu_{agg}(Z_2) = \max\{\min[0, \mu_{VL}(Z_2)], \min[0.18, \mu_L(Z_2)], \min[0.82, \mu_M(Z_2)], \min[0, \mu_H(Z_2)]\}$ .

By applying the mean of maximum method for defuzzification, the intersection point of the line  $\mu = 0.82$  with the triangular fuzzy number  $\mu_M(Z_2)$  in the equation gives the crisp output is calculated as 2045.09 mmwg.

**Figure 5.28: Aggregated output and defuzzification for the pressure of kiln**



Now we calculate the pressure of kiln to the same kiln feed, 196 tph and coal feed is 11.5 tph the fuzzy inputs are obtained as  $\mu_{LK}(196) = 0$ ,  $\mu_{MK}(196) = 1$ ,  $\mu_{HK}(196) = 0$ ,  $\mu_{LC}(11.5) = 0.18$  and  $\mu_{MC}(11.5) = 0.82$ .

Using table 5.22 the strength values of the six rules are calculated as 0, 0, 0.18, 0.82, 0, 0. Control outputs for the speed of kiln are given in table 5.26.

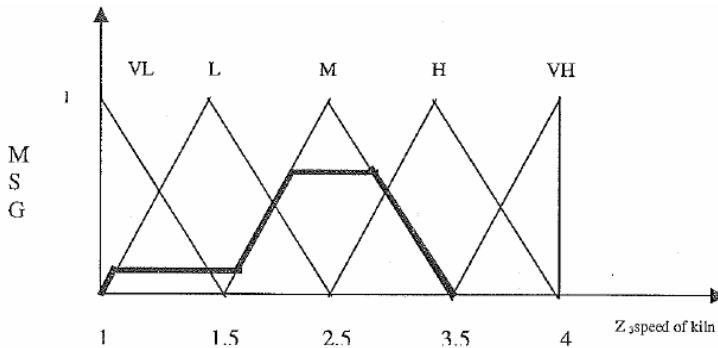
**Table 5.26: Control outputs for the pressure of kiln**

Y X	$\mu_{LC}(11.5) = 0.18$	$\mu_{MC}(11.5) = 0.82$	0
$\mu_{LK}(196) = 0$	$\min[0, \mu_{VL}(Z_3)]$	$\min[0, \mu_M(Z_3)]$	0
$\mu_{MK}(196) = 1$	$\min[0.18, \mu_L(Z_3)]$	$\min[0.82, \mu_M(Z_3)]$	0
$\mu_{HK}(196) = 0$	$\min[0, \mu_M(Z_3)]$	$\min[0, \mu_H(Z_3)]$	0

To aggregate of the control outputs, the maximum of the minimum is obtained. This is given by the following figure 5.29, that is  $\mu_{agg}(Z_3) = \max\{\min [0, \mu_{VL}(Z_3)], \min[0.18, \mu_L(Z_3)], \min[0.82, \mu_M(Z_3)], \min[0, \mu_H(Z_3)]\}$ .

By applying the mean of maximum method for defuzzification, the intersection point of the line  $\mu = 0.82$  with the triangular fuzzy number  $\mu_M(Z_3)$  in the equation gives the crisp output is obtained as 2.5rpm.

**Figure 5.29: Aggregated output and defuzzification for the speed of kiln**



From the study, the following results are derived. The unabsorbed  $\text{SO}_x$  emission to be 0.8 kilogram per ton of clinker and  $\text{NO}_x$  to be 2.25 kilogram per ton of clinker from kiln, when the kiln feed is 196 ton per hour and coal feed is 11.5 ton per hour using fuzzy control. To reduce the unabsorbed  $\text{SO}_x$  and  $\text{NO}_x$  we took the speed of kiln as 2.5 rpm and pressure of kiln as 2045 mmwg for proper mix of  $\text{SO}_x$  and  $\text{NO}_x$  in kiln using fuzzy control.

## 5.7 Conclusions

In this chapter, we have used the fuzzy control method to find the correct measure of pressure and speed of kiln. Using data from Alathur cement industry, we have used mean of maximum method of fuzzy control with the data and we found the pressure and speed of kiln.

Here the speed and pressure of kiln are important parameters in the kiln, because the  $\text{SO}_x$  and  $\text{NO}_x$  concentration is dependent on the kiln feed, coal feed and the kiln feed, coal feed are dependent on speed and pressure of kiln. That means if we increase the kiln feed and coal feed we must increase the kiln pressure and speed. By this way the mixing of  $\text{SO}_x$  and  $\text{NO}_x$  with kiln feed is maintained properly or otherwise the  $\text{SO}_x$  and  $\text{NO}_x$  will not mix fully with the kiln feed. The remaining unmixed gases of  $\text{SO}_x$  and  $\text{NO}_x$  are the wastage polluting the environment.

For this, we convert all this kiln feed and coal feed level and pressure of kiln and speed of kiln into fuzzy control. By using fuzzy control we identify a correct pressure and speed of the kiln for a given kiln feed and coal feed. When we choose a correct pressure of kiln and speed of kiln through fuzzy control, the  $\text{SO}_x$  and  $\text{NO}_x$  are fully mixed in the kiln. By this we minimize the wastage of  $\text{SO}_x$  and  $\text{NO}_x$  polluting the environment.

From the study, the following results are derived using fuzzy control

1. The unabsorbed SO<sub>x</sub> emission is found to be 0.3 kilogram per ton of clinker and NO<sub>x</sub> to be 1.54 kilogram per ton of clinker from kiln, when the kiln feed is 180 ton per hour and coal feed is 9.75 ton per hour using fuzzy control. To reduce the unabsorbed SO<sub>x</sub> and NO<sub>x</sub> the speed of kiln is taken as 1.17 rpm and pressure of kiln is taken as 2027.3 mmwg for proper mix of SO<sub>x</sub> and NO<sub>x</sub> in the kiln using fuzzy control.
2. The unabsorbed SO<sub>x</sub> emission is found to be 0.8 kilogram per ton of clinker and NO<sub>x</sub> to be 2.25 kilogram per ton of clinker from kiln, when the kiln feed is 200 ton per hour and coal feed is 12.15 ton per hour using fuzzy control. To reduce the unabsorbed SO<sub>x</sub> and NO<sub>x</sub> the speed of kiln is taken as 2.5 rpm and pressure of kiln is taken as 2045 mmwg for proper mix of SO<sub>x</sub> and NO<sub>x</sub> in kiln using fuzzy control.
3. The unabsorbed SO<sub>x</sub> emission is found to be 0.21 kilogram per ton of clinker and NO<sub>x</sub> to be 1.4085 kilogram per ton of clinker from kiln, when the kiln feed is 172 ton per hour and coal feed is 8.60 ton per hour using fuzzy control. To reduce the unabsorbed SO<sub>x</sub> and NO<sub>x</sub> the speed of kiln is taken as 1.01 rpm and pressure of kiln is taken as 2024.2 mmwg for proper mix of SO<sub>x</sub> and NO<sub>x</sub> in kiln using fuzzy control.
4. The unabsorbed SO<sub>x</sub> emission is found to be 1.166 kilogram per ton of clinker and NO<sub>x</sub> to be 2.9555 kilogram per ton of clinker from kiln, when the kiln feed is 220 ton per hour and coal feed is 14.5 ton per hour using fuzzy control. To reduce the unabsorbed SO<sub>x</sub> and NO<sub>x</sub> we took the speed of kiln as 3.83 rpm and pressure of kiln as 2064.92 mmwg for proper mix of SO<sub>x</sub> and NO<sub>x</sub> in kiln using fuzzy control.
5. The unabsorbed SO<sub>x</sub> emission is found to be 0.8 kilogram per ton of clinker and NO<sub>x</sub> to be 2.25 kilogram

per ton of clinker from kiln, when the kiln feed is 196 ton per hour and coal feed is 11.5 ton per hour using fuzzy control. To reduce the unabsorbed  $\text{SO}_x$  and  $\text{NO}_x$  the speed of kiln is taken as 2.5 rpm and pressure of kiln is taken as 2045.09 mmwg for proper mix of  $\text{SO}_x$  and  $\text{NO}_x$  in kiln using fuzzy control.

## FURTHER READING

1. Alexander H., *Biodegradation of Chemicals of Environmental concern*, Science, 211, (1981), 132-8
2. Allanthur Industries, (1998); Personal communication.
3. Atkinson, B. and Mavituna, F., *Biochemical Engineering and Biotechnology Handbook*, Macmiliam, 1983.
4. Blanco, A., Delgado, M., and Requena, I., Solving Fuzzy Relational Equations by max-min Neural Network, *Proc. 3<sup>rd</sup> IEEE Internet Conf. On Fuzzy Systems*, Orlando (1994) 1737-1742.
5. Buckley, J.J., and Hayashi, Y., Fuzzy Neural Networks: A Survey, *Fuzzy Sets and Systems*, 66 (1994) 1-13.
6. Chung, F., and Lee, T., A New Look at Solving a System of Fuzzy Relational Equations, *Fuzzy Sets and Systems*, 99 (1997) 343-353.
7. Di Nola, A., Pedrycz, W., Sessa, S., and Sanchez, E., Fuzzy Relation Equations Theory as a Basis of Fuzzy Modeling: An Overview, *Fuzzy Sets and Systems*, 40 (1991) 415-429.
8. Di Nola, A., Pedrycz, W., Sessa, S., and Wang, P.Z., Fuzzy Relation Equation under a Class of Triangular

- Norms: A Survey and New Results, *Stochastica*, 8 (1984) 99-145.
9. Di Nola, A., Sessa, S., Pedrycz, W., and Sanchez, E., *Fuzzy Relational Equations and their Application in Knowledge Engineering*, Kluwer Academic Publishers, Dordrecht, 1989.
  10. Driankov, D, Hellendoorn, H. and Reinfrank, M., *An introduction to fuzzy control*, Narosa Publishing houses New Delhi, 1997.
  11. Ezio, B. and Y.Kung. Some properties of singular value decomposition and their applications to digital signal processing, *Elsevier Science Publishers* 18 (1989) 277 – 289
  12. George, J. Klir and Bo Yuan, *Fuzzy Sets and Fuzzy logic*, Prentice Hall of India, New Delhi (1997).
  13. Grant Kessler, R Cement Kiln Dust (CKD) methods for reduction and control, *IEEE Transactions on industry applications*, 3 1 (2) (1995) 407 – 412.
  14. Hans Peter Schmauder, *Methods in Biotechnology*, Taylor and Francis, 2002
  15. Haspel, D. W. *Practical Problems with the use and Interpretation of NO<sub>x</sub> for Klin Control*, World Cement, (1989) 176-181.
  16. Holland, J., *Adaptation in Natural and Artificial Systems*, The University of Michigan Press, Ann Arbor, 1975.
  17. John E. Smith, *Biotechnology*, 3<sup>rd</sup> ed., Cambridge Univ. Press, 1996.
  18. Kagei, S., Fuzzy Relational Equation with Defuzzification Algorithm for the Largest Solution, *Fuzzy Sets and Systems*, 123 (2001) 119-127.

19. King, P.P., Biotechnology an industrial view, *J. of chemical Technology and Biotechnology*, 32, (1982) 2-8.
20. Klema, V.C. and A.J. Laub, The singular value decomposition : Its computation and some applications, *IEEE Transactions on Automatic Control*, 25(2) (1980) 164 -176.
21. Kosko, B., *Neural Networks and Fuzzy Systems: Dynamical Approach to Machine Intelligence*, Prentice-Hall, Englewood Cliffs NJ, 1992.
22. Kreft. W., The interruption of material cycles taking account of integrated further utilization in the cement plant, *Zement Kalk Gips*, (1987) 257 – 259.
23. Lars E. Ebbesen, Main fractionate crude switch control, *Comput. Chem. Eng.*, 16, (1992) S165-S171.
24. Lees, F.P., *Operability Study of a Grain Processing and Handling Facility*, Trans. ASAE., 27, (1984) 222-8.
25. Li, X., and Ruan, D., Novel Neural Algorithm Based on Fuzzy S-rules for Solving Fuzzy Relation Equations Part I, *Fuzzy Sets and Systems*, 90 (1997) 11-23.
26. Li, X., and Ruan, D., Novel Neural Algorithms Based on Fuzzy S-rules for Solving Fuzzy Relation Equations Part II, *Fuzzy Sets and Systems*, 103 (1999) 473-486.
27. Liu, F., and Smarandache, F., *Intentionally and Unintentionally. On Both, A and Non-A, in Neutrosophy.*  
<http://lanl.arxiv.org/ftp/math/papers/0201/0201009.pdf>
28. Lu, J., An Expert System Based on Fuzzy Relation Equations for PCS-1900 Cellular System Models, *Proc. South-eastern INFORMS Conference*, Myrtle Beach SC, Oct 1998.



29. Martin Sanchez M and Jose Rodellar, *Adaptive Predictive Control*, Prentice Hall, Europe, 1996.
30. McQueen, A.T., Bortz, S.J. Hatch, M.S. and Leonary, R.L., *Cement Klin NO<sub>x</sub> Control*, IEEE Transactions on Industry Applications, 31(1), (1995) 36-44.
31. Mizumoto, M., and Zimmermann, H.J., Comparisons of Fuzzy Reasoning Methods, *Fuzzy Sets and Systems*, 8 (1982) 253-283.
32. Neundorff, D., and Bohm, R., Solvability Criteria for Systems of Fuzzy Relation Equations, *Fuzzy Sets and Systems*, 80 (1996) 345-352.
33. Pavlica, V., and Petrovacki, D., About Simple Fuzzy Control and Fuzzy Control Based on Fuzzy Relational Equations, *Fuzzy Sets and Systems*, 101 (1999) 41-47.
34. Pedrycz, W., Algorithms for solving fuzzy relational equations in a probabilistic setting, *Fuzzy Sets and Systems*, 28 (1998) 183 – 202.
35. Pedrycz, W., *Fuzzy Control and Fuzzy Systems*, Wiley, New York, 1989.
36. Pedrycz, W., Inverse Problem in Fuzzy Relational Equations, *Fuzzy Sets and Systems*, 36 (1990) 277-291.
37. Pedrycz, W., Processing in Relational Structures: Fuzzy Relational Equations, *Fuzzy Sets and Systems*, 25 (1991) 77-106.
38. Pedrycz, W., s-t Fuzzy Relational Equations, *Fuzzy Sets and Systems*, 59 (1993) 189-195.
39. Ramash Ramasamy, *Industrial Ecology, A New Platform for Planning Sustainable Societies*, In: Klaus Jacob, Manfred Binder and Anna Wiczorek (eds), Governance for Industrial Transformation. Proceedings of the 2003 Berlin Conference on the Human Dimensions of Global Environmental Change,

Environmental Policy Research Centre, Berlin, (2004) 448-458.

40. Ramathilagam, S., *Mathematical Approach to the Cement Industry problems using Fuzzy Theory*, Ph.D. Dissertation, Guide: Dr. W. B. Vasantha Kandasamy, Department of Mathematics, Indian Institute of Technology, Madras, November 2002.
41. Ramco Cement Industries (1995-2001); Personal communication.
42. Sanchez, E., Resolution of Composite Fuzzy Relation Equation, *Inform. and Control*, 30 (1976) 38-48.
43. Shimada, Y. K. Suzuki and H. Sayama, Computer Aided Operability Study, *Comput. Chemical Engineering*, 20, (1995) 905-913.
44. Smarandache, F., *A Unifying Field in Logics: Neutrosophic Logic. Neutrosophy, Neutrosophic Set, Neutrosophic Probability and Statistics*, third edition, Xiquan, Phoenix, 2003.
45. Smarandache, F., *Collected Papers III*, Editura Abaddaba, Oradea, 2000.  
<http://www.gallup.unm.edu/~smarandache/CP3.pdf>
46. Smarandache, F., Definitions Derived from Neutrosophics, In Proceedings of the *First International Conference on Neutrosophy, Neutrosophic Logic, Neutrosophic Set, Neutrosophic Probability and Statistics*, University of New Mexico, Gallup, 1-3 December 2001.
47. Stamou, G.B., and Tzafestas, S.G., Neural Fuzzy Relational Systems with New Learning Algorithm, *Mathematics and Computers in Simulation*, 51 (2000) 301-314.
48. Stamou, G.B., and Tzafestas, S.G., Resolution of Composite Fuzzy Relation Equations based on

- Archimedean Triangular Norms, *Fuzzy Sets and Systems*, 120 (2001) 395-407.
49. Sugeno, M., *Industrial Applications of Fuzzy Control*, Elsevier, New York, 1985.
  50. Sundari, S., *Quality of Life of Migrant Households in Urban Slums in Martin*, J.Bunch, V Madha Suresh and T. Vasantha Kumaran, eds, Proc. of the Third International Conference on Environment and Health, Chennai, India, 537-552, 2003.
  51. Vasantha Kandasamy, W. B. and V. Indra, Maximizing the passengers comfort in the Madras transport corporation using fuzzy programming, *Progress of Mat.*, Banaras Hindu Univ., 32 (1998) 91-134
  52. Vasantha Kandasamy, W.B., Neelakantan, N.R. and Ramathilagam, S., *Minimization of Pollution by CKD in Cement Industries Using Fuzzy Theory*, *Dimensions of Pollution.*, 2, (2003) 12-43.
  53. Vasantha Kandasamy, W.B. and Florentin Smarandache, *Analysis of Pollution in Garment Industries using FAM*, (to appear).
  54. Vasantha Kandasamy, W.B. and Mary John, *Fuzzy Analysis to Study Pollution and the Disease Caused by Hazardous Waste from Textile Industries*, *Ultra Sci. Phy. Sciences*, 14, (2002) 248-251.
  55. Vasantha Kandasamy, W.B., and Smarandache, F., *Fuzzy Cognitive Maps and Neutrosophic Cognitive Maps*, Xiquan, Phoenix, 2003.
  56. Vasantha Kandasamy, W.B., and Smarandache, F., *Fuzzy Relational Equations and Neutrosophic Relational Equations*, Hexis, Church Rock, 2004.
  57. Vasantha Kandasamy, W.B., Neelakantan, N.R., and Kannan, S.R., *Operability Study on Decision Tables in a Chemical Plant using Hierarchical Genetic Fuzzy*

Control Algorithms, *Vikram Mathematical Journal*, 19 (1999) 48-59.

58. Vasantha Kandasamy, W.B., Neelakantan, N.R., and Kannan, S.R., Replacement of Algebraic Linear Equations by Fuzzy Relation Equations in Chemical Engineering, In *Recent Trends in Mathematical Sciences*, Proc. of Int. Conf. on Recent Advances in Mathematical Sciences held at IIT Kharagpur on Dec. 20-22, 2001, published by Narosa Publishing House, (2001) 161-168.
59. Vasantha Kandasamy, W.B., Neelakantan, N.R., and Ramathilagam, S., Use of Fuzzy Neural Networks to Study the Proper Proportions of Raw Material Mix in Cement Plants, *Varahmihir J. Math. Sci.*, 2 (2002) 231-246.
60. Vasantha Kandasamy, W.B., and Victor Devadoss, *A Identification of the Maximum Age Group in which Agricultural Labourers Suffer Health Hazards due to Chemical Pollution using Fuzzy Matrix*, Dimension of Pollution, 3, (2005), 1-55.
61. Venkatbabu, Indra. *Mathematical Approach to the Passengers Transportation Problem Using Fuzzy Theory*, Ph.D. Dissertation, Guide Dr. W.B.Vasantha, Dept of Mathematics, Indian Institute Technology, Chennai June 1998.
62. Yager, R.R., On Ordered Weighted Averaging Operators in Multi Criteria Decision Making, *IEEE Trans. Systems, Man and Cybernetics*, 18 (1988) 183-190.
63. Yen, J., Langari, R., and Zadeh, L.A., *Industrial Applications of Fuzzy Logic and Intelligent Systems*, IEEE Press, New York 1995.
64. Zadeh, L.A., A Theory of Approximate Reasoning, *Machine Intelligence*, 9 (1979) 149- 194.

65. Zadeh, L.A., Similarity Relations and Fuzzy Orderings, *Inform. Sci.*, 3 (1971) 177-200.
66. Zimmermann, H.J., *Fuzzy Set Theory and its Applications*, Kluwer, Boston, 1988.

# INDEX

Adaptive Predictive Control (APC), 96  
Average Time Dependent (ATD) matrix, 78  
Cement Kiln Dust (CKD), 98  
Cement kiln, 98  
Combined Time Dependent Data (CETD) matrix, 78  
Fit vector, 18-25  
Fuzzy Associative Memories (FAM), 17-8  
Fuzzy control method, 96-108  
Fuzzy control system, 100  
Hierarchical Genetic Fuzzy Control Algorithm (HGFCFA), 51-8  
Kiln speed, 97  
Pressure of kiln, 97  
Refined Time Dependent (RTD) matrix, 75-89  
Regulatory Sequence (RS), 64-5  
Structural Genes (SG), 64-5  
Transacting Factor (TAF), 64-5

## ABOUT THE AUTHORS

**Dr.W.B.Vasantha Kandasamy** is an Associate Professor in the Department of Mathematics, Indian Institute of Technology Madras, Chennai. In the past decade she has guided 13 Ph.D. scholars in the different fields of non-associative algebras, algebraic coding theory, transportation theory, fuzzy groups, and applications of fuzzy theory of the problems faced in chemical industries and cement industries.

She has to her credit 646 research papers. She has guided over 68 M.Sc. and M.Tech. projects. She has worked in collaboration projects with the Indian Space Research Organization and with the Tamil Nadu State AIDS Control Society. She is presently working on a research project funded by the Board of Research in Nuclear Sciences, Government of India. This is her 49<sup>th</sup> book.

On India's 60th Independence Day, Dr.Vasantha was conferred the Kalpana Chawla Award for Courage and Daring Enterprise by the State Government of Tamil Nadu in recognition of her sustained fight for social justice in the Indian Institute of Technology (IIT) Madras and for her contribution to mathematics. The award, instituted in the memory of Indian-American astronaut Kalpana Chawla who died aboard Space Shuttle Columbia, carried a cash prize of five lakh rupees (the highest prize-money for any Indian award) and a gold medal.

She can be contacted at [vasanthakandasamy@gmail.com](mailto:vasanthakandasamy@gmail.com)

Web Site: [http://mat.iitm.ac.in/home/wbv/public\\_html/](http://mat.iitm.ac.in/home/wbv/public_html/)

---

**Dr. Florentin Smarandache** is a Professor of Mathematics at the University of New Mexico in USA. He published over 75 books and 150 articles and notes in mathematics, physics, philosophy, psychology, rebus, literature.

In mathematics his research is in number theory, non-Euclidean geometry, synthetic geometry, algebraic structures, statistics, neutrosophic logic and set (generalizations of fuzzy logic and set respectively), neutrosophic probability (generalization of classical and imprecise probability). Also, small contributions to nuclear and particle physics, information fusion, neutrosophy (a generalization of dialectics), law of sensations and stimuli, etc. He can be contacted at [smarand@unm.edu](mailto:smarand@unm.edu)

---

**Dr. S. R. Kannan** is a faculty in Gandhigram Rural University, Tamil Nadu. He has obtained his doctorate degree in Application of fuzzy models to problems in chemical industries from Department of Mathematics, Indian Institute of Technology, Madras. He has worked as a post doctoral fellow in University of Genova, Italy and National Cheng King, University Taiwan. He has to his credit over 50 research paper in national and international journals.

---

**Dr. S. Ramathilagam** working as a faculty in one of the city colleges in Chennai. She has obtained his doctor of philosophy from the Indian Institute of Technology, Madras in application of fuzzy theory to cement industries problem. She has authored over 50 research papers.

This book uses Fuzzy Control theory, Hierarchical Genetic Fuzzy Control algorithm and special FAM to minimize pollution caused by chemicals used in cement, chemical and dyeing industries. Such pollution has not only proved hazardous to human safety and health but also to the environment polluting it beyond repair.

**ILQ**  
InfoLearnQuest

ISBN 1-59973-094-4 53995>  
  
9 781599 730943 US \$ 25.00