

On Relating a 10-dimensional and 11-dimensional Duality Model of Quantized Space-time to Elementary Particles, Quantum Gravity, and Relativistic Phenomena

Gary Heen
drrob.1150@gmail.com

Abstract- Modern theory states that matter and energy in their most basic form exist in discrete amounts, or quanta. The author proffers that space-time also exists as discrete quanta, and derives a physical model of space-time and elementary particles. The hypothesis for this space-time model is that the quanta for matter and space-time are convertible states of the same elementary building block: the quantum mass unit.

1. Introduction

In a prior publication the author proposed physical structural unit for space-time, that being the quantum space-time unit (QSU), and the relationship of the QSU to elementary particles,^[1] and parts of that paper are included in this current paper for clarity to the reader unfamiliar with the prior work. This paper looks to elucidate physical properties of the QSU, and how these properties underlie physical mechanisms responsible for gravity, relativistic phenomena, and the perceived constancy of the speed of light.

2. Physical Model of Quantized Space-time

Minkowski first proposed the linking of space and time as space-time.^[2] This paper presents a model of space-time that seeks to explicate a physical structure of space-time, and the space-time density differentials that the author proposes underlie the nature of gravity and relativistic phenomena.

2.1 Postulates

Postulate I: *Space-time and matter are physical entities of a common elemental structure, the quantum mass unit.*

The quantum mass unit (QMU) is composed of Type I strings and D-branes. It is proposed that matter and space-time are different volumetric states of the QMU, and are convertible into one another. A fully contracted QMU is a quantum particle of matter, and an expanded QMU is a unit of quantized space-time that will henceforth be referred to as a quantum space-time unit (QSU).

Postulate II: *QSUs expand spontaneously, and contract only by interacting with particle matter, or by interacting with abutting QSUs having a greater degree of contracture.*

The level of contraction, or decrease in volumetric state of a QSU from the maximally expanded state is termed the quantum level of spatial contraction (QL) of a QSU. All QSUs undergo expansion and contraction in discrete steps, known as quantum jumps.

2.2 Relating Type I strings and D-branes to Quantized Space-time Morphology

Planck's length^[3] and Planck's time^[4] quantify two of the physical parameters of the QSU. The maximally expanded QSU is a cubic hexahedron, with the length along any side equal to Planck's length (l_p), see figure 1(A). Each individual expansion or contraction of a QSU occurs in a *quantum jump* (QJ), and the time interval from initiation to completion of a quantum jump is equal to Planck's time and is invariant. After the first and any subsequent quantum jump contractions of the QSU, the cubic shape of the QSU distorts along multiple axes but maintains hexahedron shape with six planar faces, see figure 1(B). The range between maximally expanded and maximally contracted states of a QMU defines space-time curvature.

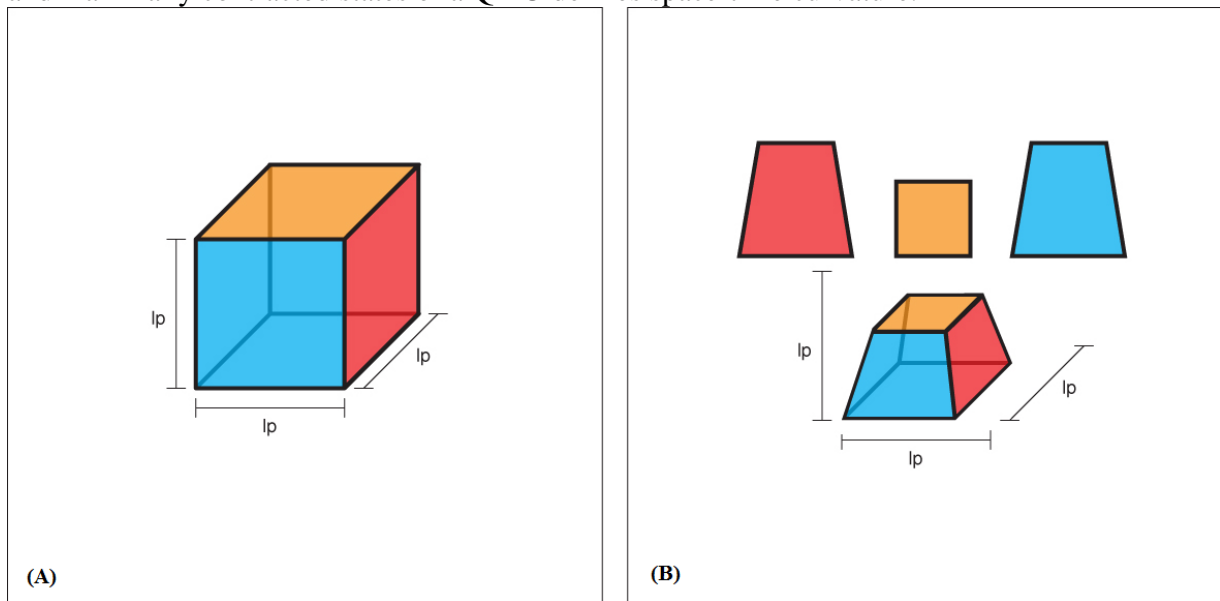

Figure 1. (A) QSU fully expanded, with each facet equaling Planck's length (B) QSU in a partially contracted state, with facet lengths less than Planck's length.

This paper's physical model of quantum space-time utilizes Type I strings and D-branes as the functional components of a QMU. D-branes were discovered independently by Petr Horava,^[5] and by the team of Jim Dai, Rob Leigh, and Joe Polchinski.^[6] The D-brane is named after 19th century mathematician Johann Peter Gustav Dirichlet.^[7] Dirichlet's boundary conditions^[8] are a set of restraints in that the Type I string ends are fixed in position, i.e. both ends of the Type I strings are attached to the D-branes. The following properties of Type I strings and D-branes are hypothesized in this paper:

1. D-branes occupy the surface of the six facets of the hexahedral QMU.
2. The Type I strings are within the QMU and attach from one facet D-brane across to the opposing parallel facet D-brane, see figure 2(A).
3. The string attachment pattern of the two facets of an axis of a QMU is a unique stereoisomeric configuration with respect to that axis, resulting in space-time and matter having chirality, see figure 2(B).
4. The opposing D-branes of the x, y, and z-axes are mirror image nonsuperposable enantiomers.

5. It is known that D-branes possess color charge,^[9] but additionally in this model the mirror image D-branes of a QMU carry equal and opposite color charges.
6. Mirror image D-branes align to match Type I string configurations of abutting QMUs and bond to one another by attraction of opposite color charges.
7. String lengths within a QSU equilibrate to approach or attain identical lengths when a QSU undergoes a geometric change.
8. The Existence of four functional sub-types of Type I strings: gravitational, electromagnetic, strong force, and weak force.
9. All QMUs have identical numbers and types of strings and D-branes.

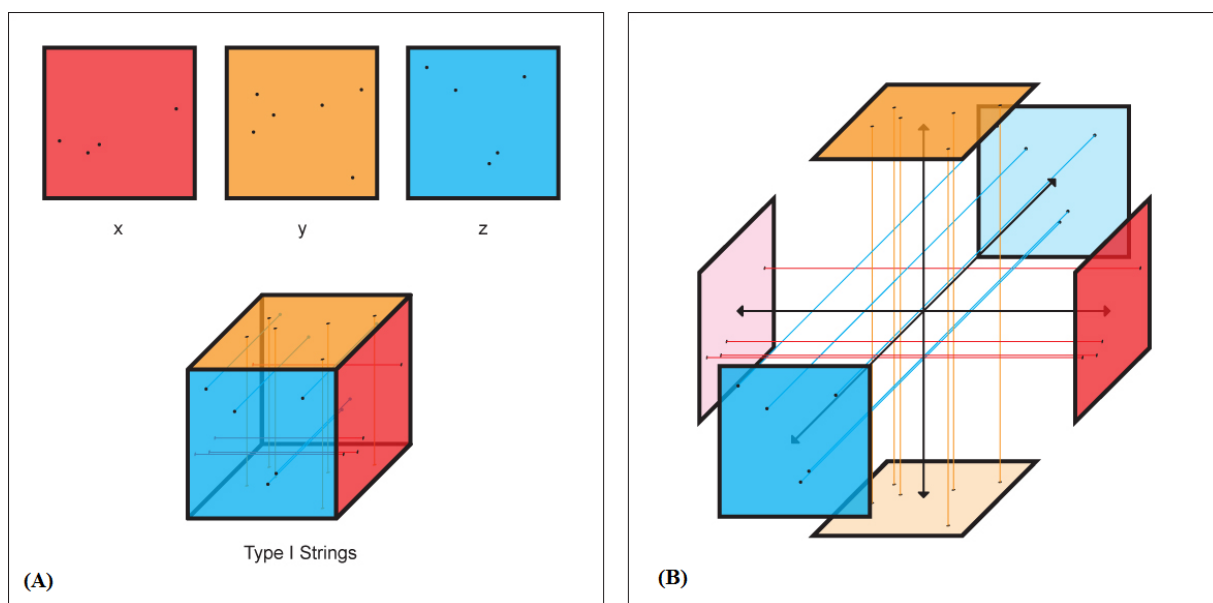

Figure 2. (A) Colored facets represent D-branes. (B) QMU exploded view, colored lines represent Type I strings.

2.3 The 10-dimensional and 11-dimensional Duality of the Quantum Mass Unit

The one-dimensional Type I strings constitute the three dimensions of the x, y, and z-axes. The author proffers that each of the D-branes occupying the six facets of the QMU are mathematically interpreted as distinct higher dimensions due to the unique stereochemistry of each of the two-dimensional D-brane sheets. The six D-branes on the QMU facets are arbitrarily named top, bottom, left, right, front, and back. The nomenclature of 2-brane will be used to distinguish the higher dimensionality of the D-brane. The 10 dimensions of the QMU are:

- | | |
|--------------------------|------------------|
| 1. x-axis Type I strings | 6. left D-brane |
| 2. y-axis Type I strings | 7. right D-brane |
| 3. z-axis Type I strings | 8. front D-brane |
| 4. top D-brane | 9. back D-brane |
| 5. bottom D-brane | 10. time |

In this paper, time is defined as the interval from initiation to completion of a geometric change in a quantum of space-time. Restated, since space and time are inexorably linked as the one entity of space-time, a change in one component of space-time necessarily causes a change in the

other; therefore, a change in the geometry of a QMU (space) is required for change in time to occur.

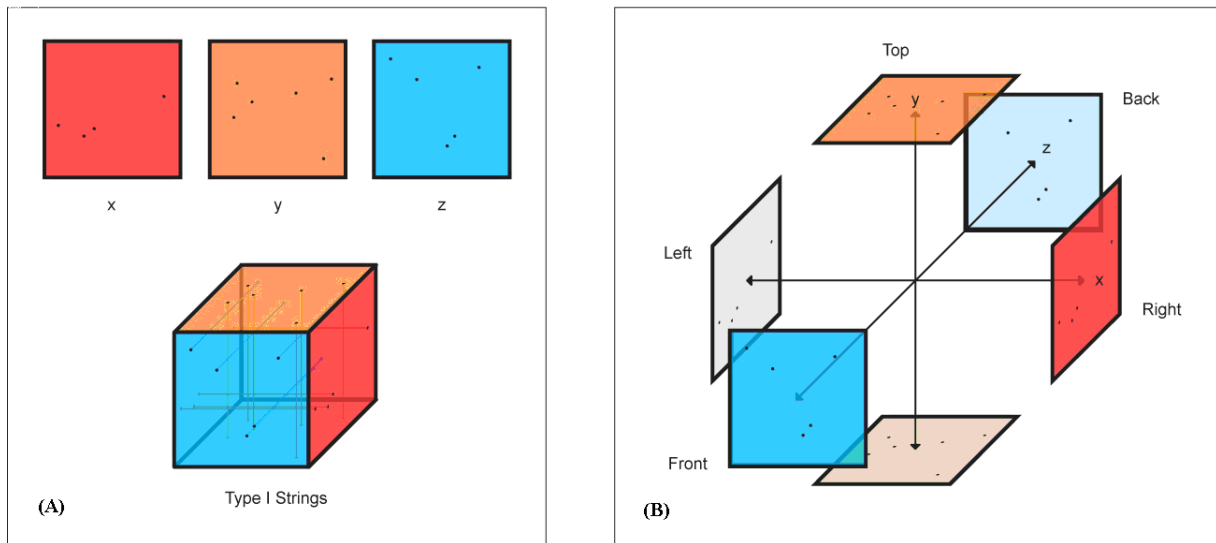

Figure 3 - The 10-dimensional QMU

The dimensionality of the QMU can also be considered 11-dimensional by presuming the following progression of dimensionality:

- (1) The linear one-dimensional Type I strings are one level of dimensionality, i.e. 1-brane.
- (2) The two-dimensional D-brane sheets are a secondary higher level of dimensionality, i.e. 2-brane.
- (3) Then, a three-dimensional configuration of all six D-branes of a QMU projecting into space simultaneously can be considered a third higher level of dimensionality, i.e. 3-brane.

Therefore, the addition of a 3-brane dimension to the ten dimensions previously outlined results in an eleven dimensional QMU. Both ten and eleven-dimensional models express the same concept of the QMU in different ways, i.e. the models are a duality. The equivalency or duality of 10-dimensional and 11-dimensional string theory has been shown mathematically.^{[10][11]}

2.4 The QMU as a Quantum Particle of Matter

This paper's model presupposes that a QMU in the fully contracted state results in the formation of a *quantum particle of matter* (QP). The QPs are posited as the elementary building blocks of matter, and are the precursors to quarks. Quarks were first predicted by Murray Gell-Mann,^[12] and George Zweig.^{[13][14]} It should be noted that opposing D-branes on any one of the three axes of a QP or QSU are mirror images of each other, e.g. the left and right D-branes of the x-axis are mirror images, as are the top and bottom D-branes of the y-axis, and the front and back D-branes of the z-axis, see figure two. A photon of sufficient energy interacting with a QSU will contract a QSU into a quantum particle of matter, designated QP¹. Subsequently, each axis of QP¹ generates mirror image quantum particle pairs (matter and antimatter), designated as QP² pairs, from QSUs abutting QP¹. QP² pairs propagate to form three stereo-chemically distinct matter and antimatter quark pairs. See Section 3.5, "Space-time Conversion into Matter and

Antimatter" for a more precise explanation of space-time-matter conversion, and matter-antimatter structure and properties.

The author posits that matter warps space-time because QPs are smaller than the abutting expanded QSUs of space-time, i.e. QSU geometry distorts due to the process of string alignment and D-brane charge between the QP and the QSU, see figure 4.

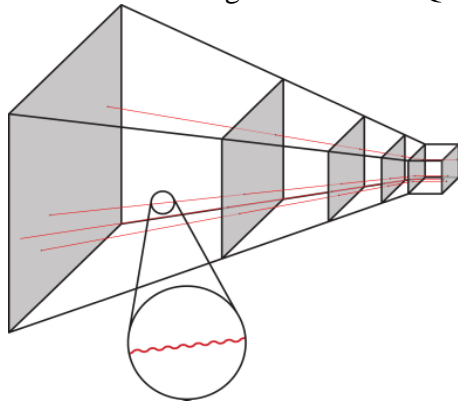

Figure 4- Space-time warpage by Particle Matter- The cube represents a quantum particle of matter. The non-cubic hexahedrons represent the QSUs of space-time. The strings of the QSU abutting the quantum particle warp the QSU when aligning with strings of the particle matter.

This model defines the universe as being composed of a *finite* number of QMUs, in which both the expanded QMUs (quantum space-time), and fully contracted QMUs (particle matter), must be present and generally contiguousⁱ; and that the universe came into existence when the first QSU expanded from the Big Bang singularity.[¹⁵] The author proposes the universe is a bubble composed of QMUs, and "outside" of this bubble is undefined. If mentally running time backwards to the Big Bang, current mathematics describing the universe will cease to function prior to the Big Bang; this is a result of the absence of the expanded state of the QSU, since the QSU imparts the dimensions of both length and time to the universe. If QSUs are not present, then there can be no time, as we understand it; further, without QSUs there is no measure of length or distance between QPs. The loss of dimensionality becomes apparent when matter enters a black hole and accretes on the singularity. It is proposed in this model that any singularity consists of a solid core of QPs with no space-time intervening between QPs. Matter accreting on a singularity appears mathematically to disappear into a point, and only the gravity of the matter that was seemingly crushed out of existence appearing to remain. The author posits that prior to the Big Bang, equations describing the universe cannot function due to the non-existence of QSUs to impart space and time dimensions to the Big Bang singularity.

3. Gravity

This paper's model defines gravity of a body as a self-interaction of matter creating a gravitational field, and the matter concertedly interacting with the generated gravitational field.

ⁱ A QSU is often temporarily discontinuous when contracting, but will equilibrate to adjacent QSUs to reestablish physical contact.

3.1 Relating QSU Volumetric State to Time, String Tension, and Space-time Energy

The *quantum level of spatial contraction* (QL) is a number that describes the geometric dimensions of the hexahedral quantum space-time unit. Each QL is described by the eight vertices of the hexahedron, and each vertex is described by three spatial coordinates and time, resulting in the 32 parameters that define a QL state. A QL change occurs in a quantum jump (QJ); from the initiation to completion of a QJ requires a single Planck's time interval. The number of QJ contractions away from a maximally expanded QSU configuration defines the numeric value of the QL of that QSU, see figure 5.

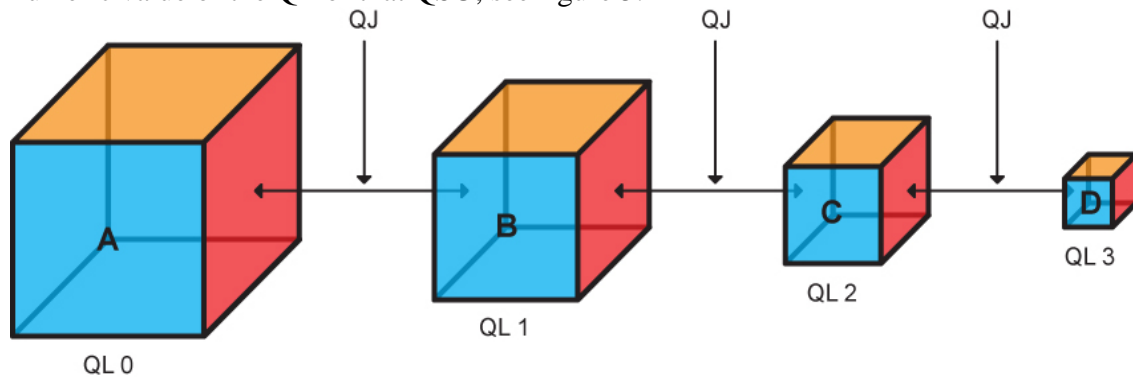

Figure 5- Quantum level changes with successive quantum jumps: Cube A represents a QSU in fully expanded state, and cubes B, C, and D in progressive QJ contracted geometric configurations illustrate the QL of a QSU at each subsequent QJ. The final QL is the net total number of QJs from the maximally expanded state of the QSU. The sizes of the QL contractions in figure 7 are greatly exaggerated for clarity.

The QL of a QSU is a state function, i.e. the change in QL of a QSU depends only on the initial and final QLs of the QSU, and not the path of the number of expansions and contractions of the QSU leading to the final QSU QL state, see figure 6.

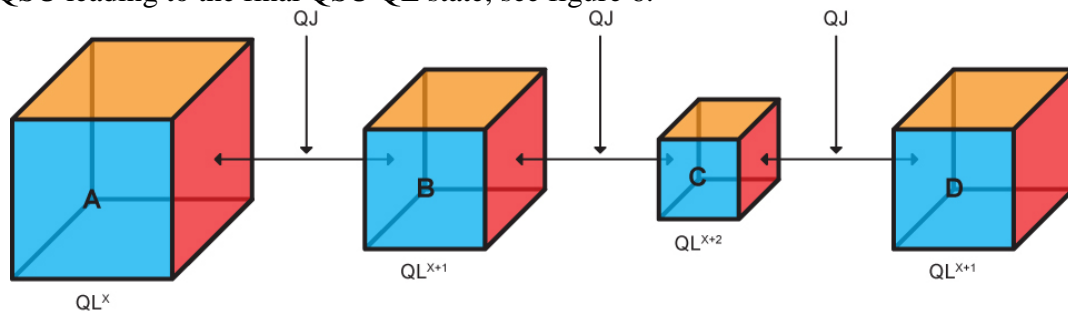

Figure 6- QL State Function of the QSU. A QSU undergoes three quantum jumps with an initial arbitrary value of x , denoted as QL^x , as in cube A. The QSU quantum jumps and contracts from QL^x to QL^{x+1} as in cube B. The QSU now undergoes a quantum jump and contracts a second time to QL^{x+2} as in cube C. Finally, the QSU Quantum jumps and expands to QL^{x+1} as in cube D. Though the QSU has undergone three quantum level changes, the net change in the QSU quantum level is one QL. It is not the *number* of Quantum jumps a QSU undergoes that determines quantum level, but it is the *net difference* in quantum jumps from the initial to the final quantum level.

The rules of this paper's space-time model of QSU QL expansion and contraction are as follows:

1. QSUs spontaneously expand to a lower QL but can never spontaneously contract to a higher QL, and the interval from initiation to completion of a QL change occurs in Planck's time.

2. A QSU will spontaneously expand in QJs to approach a QL of zero, the maximally expanded QL state.
3. Abutting QSUs with unequal QLs will interact in QJs to approach or attain equal QLs.

3.2 Interpreting Quantized Space-time String-to-String Tension Differentials as a Field Gradient

Paul Dirac proposed field quantization in 1929, later to be known as relativistic quantum field theory.^[16] Paul Dirac stated, "...with the new theory of electrodynamics we are rather forced to have an aether."^[17] The author concurs with Dirac's statement and further proposes that the aether is a physical continuum of QSUs.

The propagation of string tension from QSUs abutting a particle body to the QSUs not in direct contact with the body results in string tension radiating through the QSUs in proximity to the body. The subsequent outward radiating string tension from the body defines a quantized *space-time field* (SF). Restated, a space-time field is a result of the tension of the Type I strings at the 2-brane of one QSU interacting and altering the tension of the corresponding strings and D-branes in an abutting QSU. Each of the four proposed string types has a corresponding space-time field. The range of action of the space-time fields varies: the range of strong force SF (SF_s) is approximately 10^{-13} cm ,^[18] the range of the weak force SF (SF_w) is approximately 10^{-15} cm .^[19] Currently accepted theory states the range of action for gravity and electromagnetism is infinite. Therefore, the gravitational SF (SF_g) and electromagnetic SF (SF_e) fields are infinite.

An idealized non-rotating spherical body at rest or in uniform motion has a SF_g that is symmetrical along all axes of the body. The SF_g is composed of a gradient of abutting concentric shells of QSUs. All the QSUs of a shell have identical QLs, and geometry of the QSUs is hexahedral in shape. Expanding outward, each subsequent shell is one QL lower than the previous shell, see figure 7.

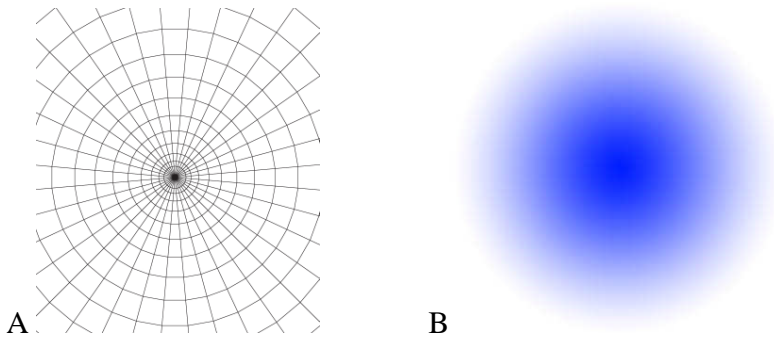

Figure 7 - (A) The 2-dimensional figure represents a space-time field of concentric QLs of a body (QL size exaggerated for clarity). (B) The 3-dimensional graphic represents a space-time field differential surrounding a body.

This linear reduction is expressed mathematically as, “the quantum level contraction state of space-time exerted by a *single* body is proportional to the mass of the body, and inversely proportional to distance”, as in

$$QL \propto \frac{m}{r} \quad (3.1)$$

where QL is the quantum level of spatial contraction, m is the mass of the body, and r is the radius from the center of mass of the body. The QL of a QSU is inversely related to the entropy (S) of the QSU,

$$S \propto \frac{1}{QL} \quad (3.2)$$

i.e. the greater the contracted state of a QSU, the higher the QL and the lower the entropy. The QL of a QSU is proportional to the energy level of a QSU,

$$E \propto QL \quad (3.3)$$

i.e. the greater the contracted state of a QSU, the higher the energy content of the QSU. By examination of equations 3.2 and 3.3, it can be seen that energy is inversely proportional to entropy, as shown in equation 3.4.

$$E \propto \frac{1}{S} \quad (3.4)$$

Therefore, in a system where the QSUs expand, entropy increases and energy decreases. The entropy of a QSU is a state function, i.e. the change in entropy of a QSU depends only on the initial and final QL of the QSU, and not the path of the number of expansions and contractions of the QSU leading to the final QSU QL state.

The QL of a QSU is proportional to the gravitational strength (force) of a QSU. Therefore, an increase in QL of a QSU equals an increase in gravitational force of the QSU. The gravitational force of a *single* body can now be rewritten as Equation 3.5,

$$F_g \propto \frac{m}{r} \quad (3.5)$$

When *two* bodies gravitationally interact, exerting gravitational forces simultaneously on one another, the equation for gravitational force is equal to the product of each body's force on the other, as in

$$F \propto \left(\frac{m_1}{r_1} \right) \left(\frac{m_2}{r_2} \right) \quad (3.6)$$

Since r_1 is the distance from the center of mass of m_1 to the center of mass of m_2 , it equals r_2 which is the distance from the center of mass of m_2 to the center of mass of m_1 , equation 3.6 can now be rewritten as,

$$F \propto \frac{m_1 m_2}{r^2} \quad (3.7)$$

Using the appropriate units of measure, and inserting Newton's gravitational constant into equation 3.7, derives Newton's universal law of gravitation,^[20] equation 3.8:

$$F = G \frac{m_1 m_2}{r^2} \quad (3.8)$$

The energy level of a QSU corresponds to its QL; consequently, an increased QL corresponds to an increase in QSU energy, just as a decreased QL represents the reverse. QSUs spontaneously *expand* to a lower QL, but never *contract* spontaneously; this is the equivalent of the second law of thermodynamics translated into this paper's space-time terms, i.e. a region of lower space-time energy cannot spontaneously transfer energy to an abutting region of higher space-time energy. QSUs undergo an increase in QL only by interacting either with QSUs having a higher QL, or with particle matter. Abutting QSUs with unequal QLs will interact in QJs to approach or equal the same QL.

In Quantum Field Theory, a graviton is a hypothetical massless particle that mediates gravity.[²¹] The author proffers that a graviton is not a free moving physical structure traversing an empty void, but instead the graviton is representative of QSU-to-QSU gravitational *string interaction* between abutting QSUs of the space-time continuum. Since the graviton is a propagating string interaction, the graviton is not a discrete particle and has no mass.

3.3 Space-time Field of a Uniformly Moving Body

The gravitational movement of any body is due to the concerted interaction of mass and space-time, and is expressed mathematically in Einstein's field equations,

$$R_{\mu\nu} - \frac{1}{2} g_{\mu\nu} R - g_{\mu\nu} \Lambda = -\frac{8\pi G}{c^4} T_{\mu\nu}. \quad (3.9)$$

where $R_{\mu\nu}$ is the Ricci tensor, $g_{\mu\nu}$ the metric tensor, R is the scalar curvature, Λ is the cosmological constant, G is the gravitational constant, c is the speed of light, and $T_{\mu\nu}$ is the stress-energy tensor. The left side of the equation expresses how space-time is warped by matter, and the right side expresses how a matter moves through space-time, i.e. the gravity field. Gravity can be thought of as the interaction of a body curving space-time, with the space-time curvature determining how the body moves.

In the case of a uniformly moving body, the author proffers an interpretation of Einstein's field equations that space-time does not move through a body, i.e. space-time between the particles of matter within the body remain fixed within the body. These fixed QSUs within the body mass are designated the *inertial frame of reference* (F_r) space-time field. The QSUs surrounding the F_r sequentially contract, propagating a wave which moves the body forward, and are designated the *space-time field wave* (ψ), see figure 11. The steady state of the F_r of the body stabilizes and maintains the QSU equilibration process of the ψ differential, maintaining self-propagating movement and preventing the ψ wave from radiating away. A body moving uniformly through space-time can be visualized as a stable capsule (body and F_r) surrounded by the ψ wave which moves the body through space-time, see figure 8. The ψ wave of this model is not an original concept; it has similarities to the *matter wave* of Louis de Broglie[²²] and the *pilot wave* of David Bohm.[²³]

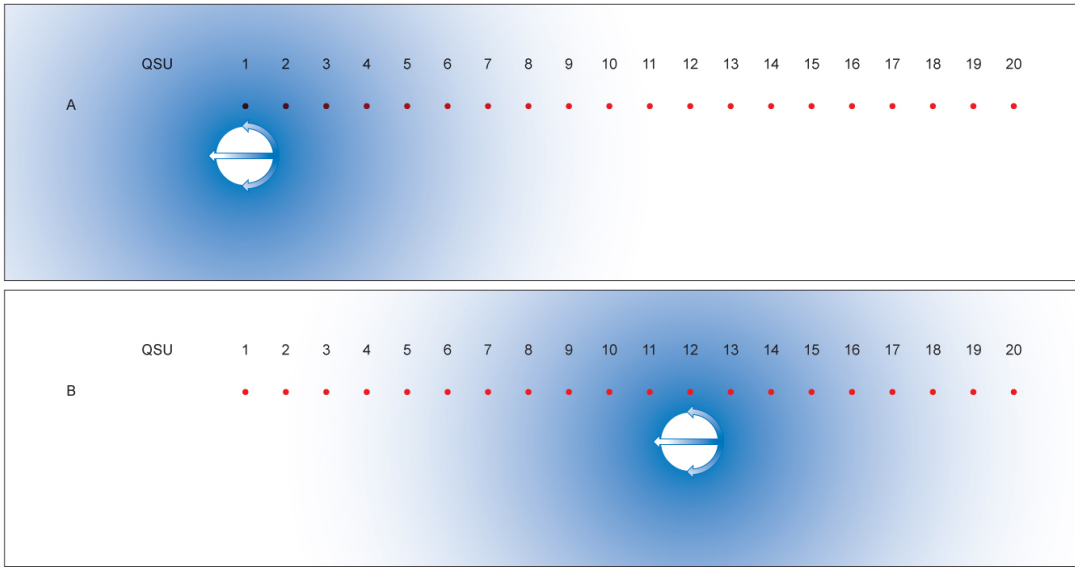

Figure 8- F_r and ψ motion diagram. The white dot at the center of the figure represents the F_r , and the blue surrounding the white dot represents ψ . The blue arrows indicate the ψ contracting around the body, moving the body forward.

3.4 Reference Frame Changes to a Body Under Acceleration

When the ψ wave of a body in uniform motion encounters a gravitational field, the QSUs of the ψ wave interact with the QSUs of the gravitational field disrupting the sequence of contractions of the ψ wave, changing the direction and/or speed of the body, i.e. the body undergoes acceleration. The altered ψ wave interacts with the F_r , destabilizing the F_r 's constant state, i.e. the QSUs of the F_r either contract or expand depending on the density of the gravitational field the body is interacting with.

3.5 Space-time Conversion into Matter and Anti-matter

It is presupposed in this model that a QMU in the fully contracted state results in the formation of a *quantum particle of matter* (QP). The QPs are posited as the elementary building blocks of matter, and are the precursors to quarks. Quarks were first predicted by Murray Gell-Mann,^[24] and George Zweig.^{[25][26]}

Paul Dirac developed his relativistic wave equation for the electron in 1928,^[27] and this equation predicted that a photon of sufficient energy could produce an electron and a particle exactly the same as the electron but with an opposite charge (anti-matter).^[28] Carl Anderson is credited for discovering empirical evidence for the existence of anti-matter in a cloud chamber experiment in 1932.^[29]

In this model matter and anti-matter differ in that each is the physical nonsuperposable mirror image enantiomer of the other, which is contrary to Dirac's statement that the particles are identical but differ only in charge sign. If paired of enantiomers are charged, the enantiomers will possess equal and opposite charges due to their mirror image geometry. Restated, what differentiates matter and anti-matter is the geometry of enantiomeric particle pairs, and not the sign of charge of the particle. A sub-atomic particle without charge, e.g. a neutron, has an anti-matter partner, which is an enantiomer of the neutron.

The author suggests that the formation of matter and anti-matter occurs when a photon with sufficient energy interacts with a QMU of space-time, and generates particle pair aggregates from opposing mirror image D-branes of any one of the three axes of the QMU. Therefore, three distinct QP matter and anti-matter color charge pairs serve as elemental building blocks for particle matter, with the color charge pairs being the three elements of the special unitary group 3 (SU(3)). SU(3) has been shown to provide a mathematical basis for describing the relationships of elementary particles.[³⁰][³¹]

Einstein's equation for energy and mass equivalence is shown in equation 3.10,[³²]

$$E = mc^2 \quad (3.10)$$

The author posits that energy, matter, and space-time are convertible, with the conversion of space-time into matter occurring when a quantum space-time unit contracts into its maximal contracted state.

Equation 3.11 indicates the mathematical relationships of energy, matter, and space-time. The term m is the mass of a *single* quantum particle of matter. The state of contraction of a QSU is defined as the quantum level of contraction (QL). The energy of a space-time unit may be stated mathematically by inserting a term into Einstein's equation, which expresses the quantum level of spatial contraction of the quantum space-time unit; QL^x is the quantum level of a QSU, and QL^n represents the QL of particle matter. Inputting energy into a QSU increases the QSU's QL, and if enough energy is absorbed by the QSU, the QSU will contract until the QL^x equals QL^n then equation 3.11 reduces to Einstein's equation, at which point space-time converts into matter.

$$E = \left(\frac{QL^x}{QL^n} \right) mc^2 \quad (3.11)$$

Using the modern values for G , h , and c as listed in CODATA,[³³] the values for Planck's natural units of length and time are shown in equations 3.12 and 3.11.[³⁴]

$$l_p = \sqrt{\frac{Gh}{c^3}} = \sqrt{\frac{(6.6742 \times 10^{-8} \text{ cm}^3 \text{ g}^{-1} \text{ s}^{-2})(6.6261 \times 10^{-27} \text{ g} \cdot \text{cm}^2 \cdot \text{s}^{-1})}{(2.9979 \times 10^{10} \text{ cm} \cdot \text{s}^{-1})^3}} = 4.0513 \times 10^{-33} \text{ cm} \quad (3.12)$$

$$t_p = \sqrt{\frac{Gh}{c^5}} = \sqrt{\frac{(6.6742 \times 10^{-8} \text{ cm}^3 \text{ g}^{-1} \text{ s}^{-2})(6.6261 \times 10^{-27} \text{ g} \cdot \text{cm}^2 \cdot \text{s}^{-1})}{(2.9979 \times 10^{10} \text{ cm} \cdot \text{s}^{-1})^5}} = 1.3512 \times 10^{-43} \text{ s} \quad (3.13)$$

In a vacuum not under the influence of matter, a maximally expanded QSU has a length along the x, y, or z-axes equaling one Planck's length. If one Planck's length is also the smallest unit of distance because space-time is quantized and cannot be further sub-divided, then the smallest possible wavelength also equals Planck's length. Since frequency multiplied by wavelength equals the speed of light, $c = \nu\lambda$, then $\nu = c / \lambda$, then the highest possible frequency equals,

$$v_{\max} = \frac{c}{\lambda} = \frac{2.9979 \times 10^{10} \text{ cm} \cdot \text{s}^{-1}}{4.0513 \times 10^{-33} \text{ cm}} = 7.4000 \times 10^{42} \text{ s}^{-1} \quad (3.14)$$

It has been posited that a photon of *sufficient* electromagnetic energy interacts with a QSU, the QSU will convert into particle matter. It must be determined whether an individual photon can possess sufficient EM energy for QSU-matter conversion to occur. The author chooses to use the hypothetically highest frequency photon because it contains the greatest energy for possibly transforming space-time into matter. Equation 3.15 shows the relationship of energy as a function of EM frequency. Substituting the value from equation 3.14 into the equation for energy frequency, the calculation of the maximum possible EM energy of a space-time photon is

$$E = hf = (6.6261 \times 10^{-27} \text{ g} \cdot \text{cm}^2 \cdot \text{s}^{-1})(7.4000 \times 10^{42} \text{ s}^{-1}) = 4.9033 \times 10^{16} \text{ g} \cdot \text{cm}^2 \cdot \text{s}^{-2} \quad (3.15)$$

Substituting the energy value of a maximum frequency photon from equation 3.14 into equation 3.1 and solving for mass is shown in equation 3.16,

$$m = \frac{E}{c^2} = \frac{4.9033 \times 10^{16} \text{ g} \cdot \text{cm}^2 \cdot \text{s}^{-2}}{(2.9979 \times 10^{10} \text{ cm} \cdot \text{s}^{-1})^2} = 5.4556 \times 10^{-5} \text{ g} \quad (3.16)$$

It becomes apparent that one photon can possess enough EM energy to convert space-time into matter. It is interesting to note the value $5.4556 \times 10^{-5} \text{ g}$ is equal to Planck's mass, as calculated using currently accepted values for G , h , and c as listed in CODATA,[³⁵] see equations 3.17 and 3.18,

$$m_p = \sqrt{\frac{hc}{G}} = 5.4556 \times 10^{-5} \text{ g} \quad (3.17)$$

$$m_p = \sqrt{\frac{(6.6261 \times 10^{-27} \text{ g} \cdot \text{cm}^2 \cdot \text{s}^{-1})(2.9979 \times 10^{10} \text{ cm} \cdot \text{s}^{-1})}{6.6742 \times 10^{-8} \text{ g} \cdot \text{cm}^2 \cdot \text{s}^{-1}}} = 5.4556 \times 10^{-5} \text{ g} \quad (3.18)$$

Therefore, Planck's mass is that amount of mass that can be converted from space-time into equal quantities of matter and anti-matter totaling $5.4556 \times 10^{-5} \text{ g}$ by a maximum frequency photon.

It is proposed in this model that a vacuum is a volume of space devoid of particle matter, and that volume is occupied by QSUs constantly undergoing QL changes as the QSUs equilibrate to approach or attain the same QL with abutting QSUs. The expansion and contraction of the QSUs is analogous to bubbles constituting a quantum foam,[³⁶] and within this foam energetic photons convert QSUs into matter and anti-matter pairs known as *virtual particles*.

The formation of matter particles from spacetime results in a void or *wormhole* of non-contiguous QSUs in the spacetime continuum. This wormhole is a consequence from the QSU

particle conversion process tunneling through contiguous QSUs of spacetime as fundamental particles such as electrons or nucleons are being created. The newly formed particles adhere onto the particle aggregate mass and move away with the particle aggregate as it tunnels through spacetime, creating a void where the converted QSUs once resided. These wormholes are unstable and have a fleeting existence, and are approximately several Planck lengths in width. As stated in Section Two, this model defines the universe as being composed of a finite number of QMUs, in which both the expanded QMUs (quantum spacetime), and fully contracted QMUs (particle matter), must be present and contiguous. Matter entering a wormhole of sufficient size as to lose contact with the QSUs of spacetime, would no longer reside in this universe, and would not be under the constraints of moving through QSUs that limit the speed of movement to the speed of light, (see Section Five- "The Speed of Light", for a in depth explanation of speed limitations); the matter would enter at one end of the wormhole, and may instantaneously exit the other end of the wormhole.

3.6 Dark Mass and Dark Energy

The question arises as to why the quantized space-time continuum has eluded detection, and the author proposes two reasons: (1) the movement of particle matter through space-time has *no resistance* due to the QSUs actually pushing/pulling any particle matter in uniform motion through space-time. (2) The F_r of a body in uniform motion prevents the quantized space-time of the ψ from flowing through the body, therefore preventing the detection of the space-time continuum within the F_r .

Observation of the effects of the space-time continuum does occur, but under the nomenclature of inertia and momentum. It is the geometry and sequence of equilibration of space-time wave function (ψ) surrounding the body that determines the body's inertia or momentum. A change in energy to the QSUs of the ψ space-time wave must occur in order to alter the sequence of contraction of the QSUs, which in turn causes a change in velocity of the body.

The author hypothesizes that of all of the QMUs that make up the universe, perhaps greater than 90%, are in the QSU unobserved "dark" mass state. However, it is likely there are other types of dark mass contributing to the total amount of dark mass, including but not limited to subatomic particles,^{[37][38]} MACHOs,^{[39][40]} and WIMPs.^{[41][42]}

The cosmological constant, once thought to be a mistake in Einstein's field equations, may in fact be a necessary mathematical term to express the spontaneous expansion of QSUs as stated in Postulate II of this paper. The energy of spontaneous QSU expansion will be referred to as dark energy.

4. Length Contraction and Time Dilation

In this section, the author puts forth an interpretation that is contrary to currently accepted views of length contraction and time dilation. The author proposes that length contraction occurs when a body undergoes acceleration, but the length contraction occurs to the *space-time* in proximity to the body, and not the body itself, and that the increase in space-time density results in a consequent length contraction with subsequent time dilation to the body.

4.1 Length Contraction

A body that undergoes acceleration produces localized time dilation and length contraction effects. The Lorentz transformations describe these changes,^[43] as shown in equation 4.1 for time and 4.2 for length

$$t' = \gamma t, \quad (4.1)$$

$$l' = l / \gamma, \quad (4.2)$$

where t' is time in a relative moving frame, t is time in the rest frame, l' is length in a relative moving frame, l is length in the rest frame, and $\gamma = 1 / \sqrt{1 - (v^2 / c^2)}$.

The forces of electrostatic repulsion must be considered in order to evaluate the physical interpretation of length contraction, the reason for which will be explained in the following paragraphs of this subsection. The ratio of electrostatic force to gravitational force for two electrons is 4.17×10^{42} ,^[44] as in

$$\frac{F_e}{F_g} = \frac{ke_1^- e_2^- / r^2}{Gm_1 m_2 / r^2} = \frac{ke_1^- e_2^-}{Gm_1 m_2} = 4.17 \times 10^{42}. \quad (4.3)$$

However, the ratio of electrostatic force to gravitational force between identical atoms or identical molecules is variable, depending on the respective number of protons and neutrons constituting the atoms and molecules. Therefore, there is no fixed value for the ratio of F_e to F_g but 10^{42} suffices as an approximation. The following paragraphs will utilize this large ratio in explaining the resistance of a body in motion to contract.

As stated in section 3.1, as a moving body's local space-time contracts, the body's gravity increases. However, at speeds less than $0.99c$ the increase in gravity is relatively weak, and is insufficient to overcome the 10^{42} greater repulsive electromagnetic force, which would be required to contract the body in proportion to the Lorentz length contraction equation.

To date, no published experiment has confirmed the existence of length contraction of a moving body by *direct* observation. Well-known experiments that fail to show length contraction include Trouton-Rankine^[45] and Tomaschek.^{[46][47][48]} Several experiments purport to confirm the existence of length contraction by *indirect* evidence, in particular Pound-Rebka^{[49][50]} and Pound-Snider.^[51] The author concurs that length contraction does occur when a body is in motion, but he proffers the current interpretation that the body contracts is incorrect, and posits it is *space-time* surrounding a moving body that contracts, and not the body itself. The following section will elucidate length contraction and time dilation of a moving body.

4.2 Time Dilation

Length contraction of the local space-time surrounding the body leads directly to time dilation of the body as the following example illustrates. A body moving uniformly at .866 the speed of light interacts with local space-time, increasing space-time density by contracting the QSUs that surround the body. Substituting .866 into Equation 4.2 yields a length contracture of 0.5. The QSUs initially contract only in the direction of motion, but the strings within the QSU undergo equilibration to approach or attain equal lengths in all axes, maintaining the QSU in an approximate cuboidal geometry. Therefore, QSUs of the space-time field of reference (F_r)

surrounding the body, contract along *all three axes* to one-half their initial length, which doubles the number of QSUs between any two particles of matter.

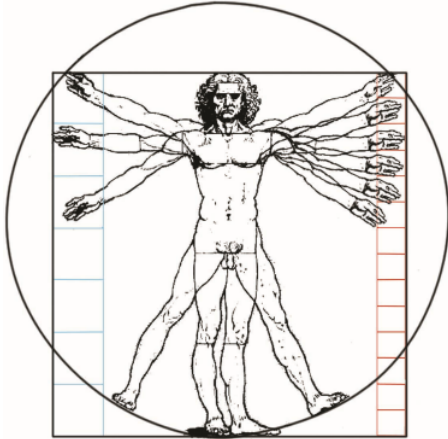

Figure 9

In Figure 9, the model's right arm side represents a space-time field density of seven QSUs from head to toe, and the model's figure's left arm side represents a space-time field density of fourteen QSUs from head to toe. It is possible to observe time dilation between these two fields when the model raises both arms simultaneously from his navel to the top of his head. The figure's right arm traverses three QSUs at a rate of one QSU per unit time T_0 , and the model's left arm traverses six QSUs at the same rate of one QSU per unit time T_0 . It is apparent to a non-local observer, i.e. an observer outside of the model's reference frame, that the model's left arm takes twice as long to traverse from his navel to the top of his head due to its passing through twice as many QSUs as the right arm. Placing a clock in the right hand and an identical clock in the left hand, both clocks will register three time units for their respective arms to move from the navel to the top of the head. This is not a paradox because even though the figure's left side takes twice as long to travel the distance, the clock would run half as fast in the left side's denser space-time field. This is because the figure's left side clock's moving parts would also have to pass through twice as many QSU's in the figure's left hand space-time field and would run at half speed. Therefore, a local observer in either the left hand or right hand space-time field will observe the clock register the passage of three units of time to move the arm from the navel to the head, but an outside observer not within either reference frame will observe the clocks running at different speeds. Physical time dilation is the change in time required to move between points of matter under varying space-time density conditions. The linking of space and time as space-time implies that any change in space inextricably requires a corresponding change in time. If a body that has undergone acceleration produces *time* dilation, then a length change will have occurred to the *space* surrounding the body, i.e. length contraction occurs to the body's local space-time and not to the body itself.

5. Speed of light

Albert Einstein stated in his second postulate of special relativity, "Light is always propagated in empty space with a definite velocity c which is independent of the state of motion

of the emitting body.”^[52] This section will attempt to elucidate the underlying physical nature of Einstein’s axiomatic statement.

5.1 Planck’s Units of Length and Time

Equations and original values for Planck’s natural units of length and time are shown in equations 5.1 and 5.2.^[53] Note however that Planck’s values for G , h , and c are inaccurate compared to modern accepted measurements as listed in CODATA.^[54] Consequently, substitution of currently accepted values of these constants into the formulae yields a correspondingly modern value for Planck’s length and time as shown in equations 5.3 and 5.4.

$$l_p = \sqrt{Gh/c^3} = 4.13 \times 10^{-33} \text{ cm} \quad (5.1)$$

$$t_p = \sqrt{Gh/c^5} = 1.38 \times 10^{-43} \text{ s} \quad (5.2)$$

$$l_p = \sqrt{\frac{Gh}{c^3}} = \sqrt{\frac{(6.6742 \times 10^{-8} \text{ g} \cdot \text{cm}^2 \cdot \text{s}^{-1})(6.6261 \times 10^{-27} \text{ g} \cdot \text{cm}^2 \cdot \text{s}^{-1})}{(2.9979 \times 10^{10} \text{ cm} \cdot \text{s}^{-1})^3}} = 4.0513 \times 10^{-33} \text{ cm} \quad (5.3)$$

$$t_p = \sqrt{\frac{Gh}{c^5}} = \sqrt{\frac{(6.6742 \times 10^{-8} \text{ g} \cdot \text{cm}^2 \cdot \text{s}^{-1})(6.6261 \times 10^{-27} \text{ g} \cdot \text{cm}^2 \cdot \text{s}^{-1})}{(2.9979 \times 10^{10} \text{ cm} \cdot \text{s}^{-1})^5}} = 1.3512 \times 10^{-43} \text{ s} \quad (5.4)$$

5.2 The Photon

The author proffers that a photon is not an individual particle traversing an empty void, but instead the photon is QSU-to-QSU EM *string interaction* between abutting QSUs of the space-time continuum. If the photon is a propagating string *interaction*, and not a discrete particle, then the photon has no mass. However, since the photon is isolated to one QSU at a time as it propagates, it appears as a particle, and as the photon propagates, an accompanying EM SF occurs at each QSU as the EM pulse traverses through abutting QSUs, and the SF appears as a wave as it passes an observer.

More than one photon can have its EM string interactions pass simultaneously through an individual QSU, along a different EM string not occupied by another photon. Therefore, the photon, as well as other zero mass bosons, can occupy the same space (QSU) at the same time. On the other hand, fermions are not like the bosons, but are fully contracted QMUs that are solid particles of matter, and cannot occupy the same space at the same time; there is simply no space for the fermions to pass through one another because the QMUs are fully contracted.

5.3 The Speed of Light

The quantum jump contraction of the QSU occurs in the same invariant time interval (Planck’s time), regardless of the contracted state of the QSU. Equation 5.5 shows the computation of the speed of light of a photon traversing maximally expanded space-time (c_m), as

$$c_m = \frac{l_p}{t_p} = \frac{4.05 \times 10^{-33} \text{ cm}}{1.3512 \times 10^{-43} \text{ s}} = 2.9979 \times 10^{10} \text{ cm} \cdot \text{s}^{-1} \quad (5.5)$$

By inspection of the algebraic formulae, this outcome is obvious, for it is self-defining,

$$c = \frac{l_p}{t_p} = \frac{\sqrt{Gh/c^3}}{\sqrt{Gh/c^5}} = \sqrt{\frac{Gh \cdot c^5}{Gh \cdot c^3}} = \sqrt{c^2} = c \quad (5.6)$$

However, using this model's concepts of length contraction and time dilation, we can now state the speed of a photon traversing a local reference frame of contracted space-time (c_c) to be

$$c_c = \frac{l_c}{t_p} \quad (5.7)$$

where l_c represents the contracted length of the QSU, and $l_c < 4.0513 \times 10^{-33} \text{ cm}$. Equation 5.7 shows that the speed of light is not constant in absolute distance crossed per unit time, but is *invariant* in traversing one QSU per Planck's time unit, see figure 10.

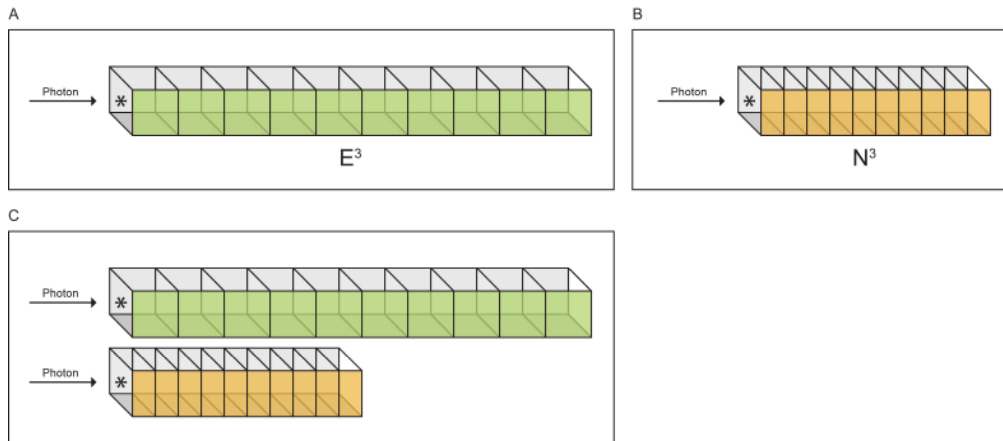

Figure 10- Euclidean (E^3) and Non-Euclidean (N^3) Geometries; (A) Euclidean reference frame with fully expanded QSUs having equal lengths along x, y, and z-axes with the time required to traverse 10 fully expanded QSUs equaling $10x T_p = 10 T_p$, and the distance traversed equaling $10x L_p = 10 L_p$. (B) Non-Euclidean reference frame with warped or contracted space-time with not all of the QSU axes equal in length. The QSUs in this case are contracted $\frac{1}{2}$ in direction of motion. The time to traverse ten contracted QSUs equals, $10x T_p = 10 T_p$ and the distance traversed equals, $10x \frac{1}{2} L_p = 5 L_p$. (C) E^3 juxtaposed to N^3 - the photon will appear to move at half the speed and move half the distance in N^3 as compared to E^3 .

The speed of light within a local reference frame of a moving body always appears to be $2.9979 \times 10^{10} \text{ cm} \cdot \text{s}^{-1}$, because an observer within a stable F_r is surrounded by QSUs with the same contraction state or QL, resulting in the observer undergoing time dilation exactly equal to the time increase a photon requires to traverse the increased number of QSUs.

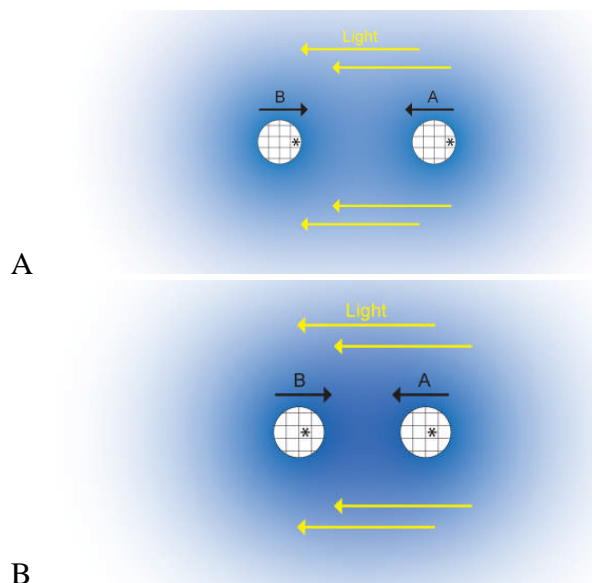

Figure 11- (A) shows two bodies **A** and **B** moving in opposite directions and at the same speed, as indicated by the black bars above the bodies. Photons from a light source coming from the same direction as body **A** enter the F_r of body **A** and body **B** at the same instant, as indicated by the asterisk. Figure (B) shows that since both bodies are moving at the same speed, the bodies have identical space-time densities of their respective F_r s, and the photons of both bodies propagate at the same rate of one QSU per Planck's time. An observer within the F_r of either body **A** or **B** will observe the speed of light at the same speed, despite moving in opposite directions from the light source.

The author suggests the *null result* of Michelson-Morley's experiment^[55] was a consequence of the false assumption that the ether (space-time continuum) moves through the interferometer because the earth is moving through the ether. The author proposes that the arms of the interferometer used in Michelson-Morley's experiment were within a stable F_r , resulting in uniform measurement of the speed of light, producing the null result for detecting the ether.

Concluding Remarks

The space-time model presented in this paper endeavors to elucidate a physical structure of space-time, and how this structure is responsible for gravitational and relativistic effects. This paper does not question the validity or accuracy of current mathematics describing quantum mechanics and relativity as put forth by Planck, Einstein, Dirac, et al. However, the mathematics do not describe the underlying nature of the universe. This model suggests a physical interpretation of the mathematics that describes gravity and relativity. The basis of this space-time model, i.e. that space is not empty, and is quantized, allows for the extrapolation to new interpretations for length contracture, time dilation, and the speed of light; these physical interpretations offer a view of the universe based upon a possible physical reality via the QMU.

The author proposes it is no coincidence that Planck's natural units describe the properties of the QMU, and puts forth that the values of G , h , and c are determined by the properties of the QMU. The calculation by Planck to determine his natural units by using G , h ,

and c was the mathematical process of inadvertent reverse engineering, which necessarily revealed the properties of the QMU.

Acknowledgements- the author would like to thank the following people for their help in reviewing this paper and their helpful suggestions: Evan Oulashin, Scott Heen, Greg Dawson, Mark Holady, and Daniel Wilkens.

[¹] G. Heen, "On Relating a 10-dimensional and 11-dimensional Duality Model of Quantized Space-time to Elementary Particles," <http://vixra.org/abs/1005.0015> (2010).

[²] H. Minkowski, Address delivered at the 80th Assembly of German Natural Scientists and Physicians, (Cologne, 1908). Published in *Physikalische Zeitschrift* **10**, 104-111 (1909).

[³] M. Planck, "Uber Irreversible Strahlungsvorgange," *Preussischen Akademie der Wissenschaften* **5** 440-480 (1899).

[⁴] Ibid.

[⁵] P. Horava, "Background Duality of Open String Models," *Physics Letters* **B231** 351 (1989).

[⁶] J. Dai, R. Leigh, and J. Polchinski, "New Connections Between String Theories," *Modern Physics Letters* **A4** 2073 (1989).

[⁷] J. Polchinski, "Dirichlet Branes and Ramon-Ramon Charges," *Physical Review Letters* **75** 4724 (1995).

[⁸] A. Cheng, and D. Cheng, "Heritage and Early History of the Boundary Element Method Dirichlet Boundary Conditions," *Engineering Analysis with Boundary Elements* **29** 268-302. (2005).

[⁹] E. Witten, "D-branes and K Theory," *Journal of High Energy Physics* 9812:019 (1998).

[¹⁰] E. Witten, lecture delivered at *Strings '95*, a conference held at USC in March, (1995).

[¹¹] P. Horava and E. Witten, "Heterotic and Type I String Dynamics from Eleven Dimensions," *Nuclear Physics* **B460**, 506 (1996).

[¹²] M. Gell-Mann, "A Schematic Model of Baryons and Mesons," *Physics Letters* **8**, 214-215 (1964).

-
- [¹³] G. Zweig, "An SU(3) Model for Strong Interaction Symmetry and its Breaking," *CERN Report* **8182-TH**, 401 (1964).
- [¹⁴] G. Zweig, "An SU(3) Model for Strong Interaction Symmetry and its Breaking: II," *CERN Report* **8419-TH**, 412 (1964).
- [¹⁵] G. Lemaître, "The Beginning of the World from the Point of View of Quantum Theory," *Nature* **127**, 706 (1931).
- [¹⁶] P. Dirac, "Quantum Mechanics of Many-Electron Systems," *Proceedings of the Royal Society of London Series A* **123**, 714-733 (1929).
- [¹⁷] P. Dirac, "Is There an Aether," *Nature* **168**, 906 (1951).
- [¹⁸] H. Yukawa, "On the Interaction of Elementary Particles I," *Proceedings of the Physics and Mathematics Society (Japan)* **17**, 48 (1935).
- [¹⁹] Y. Ne'eman and Y. Kirsh, "The Particle Hunters," 2nd Edition, 129 (1996).
- [²⁰] I. Newton, "Philosophiae Naturalis Principia Mathematica," (1687).
- [²¹] D. Blokhintsev and F. Gal'perin, *Pod Znamenem Marxisma* **6**, 147 (1934).
- [²²] L. de Broglie, "Researches on the Quantum Theory," Thesis (1924); L. de Broglie, *Annalen der Physik* **3**, 22 (1925).
- [²³] D. Bohm, "A Suggested Interpretation of the Quantum Theory in Terms of Hidden Variables," *Physical Review* **85**, 166–179 (1952).
- [²⁴] M. Gell-Mann, "A Schematic Model of Baryons and Mesons," *Physics Letters* **8** 214-215 (1964).
- [²⁵] G. Zweig, "An SU(3) Model for Strong Interaction Symmetry and its Breaking," *CERN Report* **8182-TH** 401 (1964).
- [²⁶] G. Zweig, "An SU(3) Model for Strong Interaction Symmetry and its Breaking: II," *CERN Report* **8419-TH** 412 (1964).
- [²⁷] P. Dirac, "The Quantum Theory of the Electron," *Proceedings of the Royal Society of London Series A*, Containing Papers of a Mathematical and Physical Character **117**, (778) 610-624 (1928).
- [²⁸]Ibid.
- [²⁹] C. Anderson, "The Positive Electron," *Physical Review* **43**, 491 (1933).

[³⁰] M. Gell-Mann, "A Schematic Model of Baryons and Mesons," *Physics Letters* **8** 214-215 (1964).

[³¹] G. Zweig, "An SU(3) Model for Strong Interaction Symmetry and its Breaking," *CERN Report* **8182-TH**, 401 (1964).

[³²] A. Einstein, "Does the Inertia of a Body depend on its Energy Content?" *Annalen der Physik* **18** 639-641 (1905).

[³³] CODATA Committee on data for Science and Technology, page 63, Table XXVI (2005).

[³⁴] H. Lorentz, "Electrodynamic Phenomena in a System Moving with any Velocity Less than that of Light," *Proceedings of the Academy of Science of Amsterdam* **IV**, 669-678 (1904).

[³⁵] CODATA Committee on data for Science and Technology, page 63, Table XXVI (2005).

[³⁶] J. Wheeler, "Geons," *Physical Review* **97** 511-536 (1955).

[³⁷] J. Bahcall, "Neutrino Astrophysics," Cambridge University Press. ISBN 0-521-35113-8 (1989).

[³⁸] D. Griffiths, "Introduction to Elementary Particles," Wiley, John & Sons, Inc. ISBN 0-471-60386-4, (1987).

[³⁹] C. Alcock et al., "The MACHO Project: Microlensing Results from 5.7 Years of LMC Observations," *Astrophysics Journal* **542**, 281-307 (2000).

[⁴⁰] P. Tisserand, et al., "Limits on the Macho Content of the Galactic Halo from the EROS-2 Survey of the Magellanic Clouds," Submitted to *Astronomy and Astrophysics*.

[⁴¹] F. Ferrer, L. Krauss, and S. Profumo, "Indirect Detection of Light Neutralino Dark Matter in the NMSSM," *Physical Review* **D74**, 115007 (2006).

[⁴²] J. Carr, G. Lamanna, and J. Lavalle, "Indirect Detection of Dark Matter," *Reports on Progress in Physics* **69**, 2475-2512 (2006).

[⁴³] H. Lorentz, "Electrodynamic Phenomena in a System Moving with any Velocity Less than that of Light," *Proceedings of the Academy of Science of Amsterdam* **IV**, 669-678 (1904).

[⁴⁴] R. Feynman, "The Feynman Lectures on Physics," Commemorative Edition, page 7-10, (1989).

[⁴⁵] F. Trouton and A. Rankine, "On the Electrical Resistance of Moving Matter," *Proceedings of the Royal Society of London* **80**, 420 (1908).

[⁴⁶] R. Tomaschek, "The Conduct of Light of Extraterrestrial Light Sources," *Annalen der Physik* **73**, 105–126 (1924).

[⁴⁷] R. Tomaschek, "Concerning an Experiment on the Location of Electrodynamical Effects of the Movement of the Earth at High Altitudes II," *Annalen der Physik* **80**, 509–514 (1926).

[⁴⁸] R. Tomaschek, "Comments on My Tests on the Detection of Electrodynamical Effects at High Altitudes," *Annalen der Physik* **84**, 161–162 (1927).

[⁴⁹] R. Pound and G. Rebka Jr. "Gravitational Red-Shift in Nuclear Resonance," *Physical Review Letters* **3**, 439–441 (1959).

[⁵⁰] R. Pound and G. Rebka Jr. "Apparent Weight of Photons," *Physical Review Letters* **4**, 337–341 (1960).

[⁵¹] R. Pound and J. Snider, "Effect of Gravity on Nuclear Resonance," *Physical Review Letters* **13**, 539–540 (1964).

[⁵²] A. Einstein, "Zur Elektrodynamik bewegter Körper," *Annalen der Physik*, **17** (1905).

[⁵³] H. Lorentz, "Electrodynamical Phenomena in a System Moving with any Velocity Less than that of Light," *Proceedings of the Academy of Science of Amsterdam* **IV**, 669–678 (1904).

[⁵⁴] CODATA Committee on data for Science and Technology, page 63, Table XXVI (2005).

[⁵⁵] A. Michelson and E. Morley, "The Relative Motion of the Earth and the Luminiferous Ether," *American Journal of Science* **22**, 120–129 (1887).