

SMARANDACHE GEOMETRIES
&
MAP THEORY WITH APPLICATIONS(I)

Linfan MAO

SMARANDACHE几何、地图及其应用(I)

毛林繁



Chinese Branch Xiquan House

2006

Linfan Mao

Academy of Mathematics and Systems
Chinese Academy of Sciences
Beijing 100080, P.R.China
maolinfan@163.com

**SMARANDACHE GEOMETRIES
&
MAP THEORY WITH APPLICATIONS(I)**

毛林繁

中国科学院数学与系统科学研究院
北京 100080
maolinfan@163.com

SMARANDACHE 几何、地图及其应用 (I)

Chinese Branch Xiquan House

2006

This book can be ordered in a paper bound reprint from:

Books on Demand

ProQuest Information & Learning
(University of Microfilm International)
300 N.Zeeb Road
P.O.Box 1346, Ann Arbor
MI 48106-1346, USA
Tel:1-800-521-0600(Customer Service)
<http://wwwlib.umi.com/bod>

Peer Reviewers:

Y.P.Liu, Department of Applied Mathematics, Beijing Jiaotong University, Beijing 100044, P.R.China.

F.Tian, Academy of Mathematics and Systems, Chinese Academy of Sciences, Beijing 100080, P.R.China.

J.Y.Yan, Graduate Student College, Chinese Academy of Sciences, Beijing 100083, P.R.China.

E.L.Wei, Information school, China Renmin University, Beijing 100872, P.R.China.

Copyright 2006 by Chinese Branch Xiquan House and Linfan Mao

Many books can be downloaded from the following **Digital Library of Science:**

<http://www.gallup.unm.edu/~smarandache/eBooks-otherformats.htm>

ISBN:1-59973-019-7

Printed in China

序言

数学是科学的语言和工具，是人类认识自然社会、发现其规律的科学基础。正是由于这种特性，采用已有的数学工具或建立新的数学系统去刻画自然界或科学本身给人类提出的各种问题，进而造福于人类社会就成了数学研究的首要任务。

采用数学方法解决问题是数学研究的核心。众所周知，希尔伯特在二十世纪初提出的 23 个数学问题成了二十世纪数学研究及发展的直接动力，而爱因斯坦晚年倡导的统一场论研究推进了二十世纪理论物理的发展，直接促成了弦理论/M-理论的诞生，进而提高了人类对宇宙空间的认识水平。

科学是发展的，科学又是进步的。在一个时期成立的结论在另一个时期则可能是谬误，那种认为科学是永恒真理的观点是不正确的，这当中包括对数学定理的看法，因为曾经有观点认为数学是绝对真理。科学发展到了二十一世纪，学科分得越来越细，数学工作者在其有生之年仅能在一个或数个领域内做出贡献，那种想要通晓所有数学领域的想法几乎是不现实的。科学研究工作中不同学科之间频繁交叉，重新组合成人们认识自然的有力武器 - 因为世界本身是交叉组合的。在这种形势下，促成不同数学学科之间的组合重组，并研究其产生的新问题，进而服务于科学研究和人类社会，就成了数学研究的当务之急。

什么是二十一世纪数学？二十一世纪数学是组合的数学，是经典数学的组合重组及推广的产物，也是应二十一世纪科学研究发展需要的产物。在这里，我们可以遇到一些在经典数学中不成立的命题而在新的数学系统中成为定理，甚至正命题和否命题可以同时成立。“化解矛盾，解放思想”这种处理人类社会的思想在数学中得到了进一步体现。

为使读者能够了解这种数学组合化思潮，进而对数学发展贡献其才智，这里选编了作者或作者与其他学者近年完成的 10 篇论文，除一篇为中国科学院博士后前沿与交叉学科学术论坛交流论文，另一篇在中国 2005 图论与组合数学国际学术交

流会上报告外,其他九篇论文均已有一些国际电子出版物上公开发表。

这里对各篇论文进行简要介绍如下。

“**组合思想和数学组合化猜想**”是为“全国第二届图论与组合数学学术交流会议”准备的一篇综述论文,主要依据作者在美国新近出版的**Automorphism groups of maps, surfaces and Smarandache geometries**和**Smarandache multi-space theory** 两本专著中部分材料写作,其中介绍了数学组合化猜想的提出过程,组合思想在代数组化、几何组合化中的贡献,以及组合思想在组合宇宙研究,特别是M-理论下的5维、6维宇宙研究中的贡献等内容。

“**理论物理引发的二十一世纪数学-Smarandache 重空间理论**”是作者应邀回到四川省万源市中学面向青年教师和学生介绍现代数学与物理和在“全国第二届图论与组合数学学术交流会议”上报告的一篇综述论文,其目的是介绍二十一世纪数学的产生背景、主要方法和一些结论。其中详细介绍了宇宙大爆炸模型、Smarandache 重空间、Smarandache 几何、地图与地图几何、伪度量空间几何等内容,最后对理论物理几个问题进行了一些有益的讨论,阐述了作者的一些观点。

“Smarandache 思想引发的组合地图研究方向”是采用 Smarandache 思想提出组合地图一些新的研究方向的一篇论文,曾在中国科学院数学与系统科学研究院和北京交通大学应用数学系进行报告。其中对 Iseri 教授提出的2-维 Smarandache 流形,采用组合地图的方法进行了推广并首次提出了地图几何的概念,讨论了地图几何的一些初步性质和分类,文末提出了一些经典数学定理、结论的组合化问题,对那些希望从事数学组合化研究的人不无益处。

“**地图上的 Smarandache 几何引论**”是为“2005 图论与组合数学暨第三届海峡两岸图论国际学术交流会”准备的一篇综述论文,其中介绍了地图、地图几何,特别是平面地图几何中存在平行线束的充要条件等内容,可以看作是为研究平面地图几何中欧氏第五公设而进行的工作。

“**招标评价体系的重空间模型及求解分析**”和“**招标评价体系的数学模型及求解分析**”是作者在美国 Xiquan Publishing House 出版了《**中国工程建设项目施工招标技巧与案例分析-Smarandache 重空间模型**》一书后,应美国 America Research Press 出版社的编辑 Perze 博士建议,分别采用英文和中文写作的两篇数学论文,两篇文章略有不同。是依据中国招标投标法律规定的确定中标人条件,首次采用数学方法建立投标评价体系的数学模型,进而分析、确定评标对策的一篇文章。文中指出了中国招标制度下的投标评价体系是一个有限多目标决策问题,提出了图上作业法。文末分别讨论了 Smarandache 重空间赋权带来的几个值得研究的数学问题和当前投标评价体系中存在的问题及应采取的对策。

“**曲面完全地图的计数**”和“**基础图为有限群的 Cayley 图的地图自同构及其计数**”是作者分别在 2004 年 5 月和 2001 年 11 月完成的两篇论文。文中采用群作用方法分别对曲面上的不标根完全地图和基础图为有限群的一类 Cayley 图的不等价嵌入进行了计数,包括可定向与不可定向两种情形,推广了 White 等人提出的图在曲面上不等价嵌入的计数方法,是经典数学方法应用于组合数学的两篇文章。

“**Riemann 曲面上 Hurwitz 定理得组合推广**”是采用组合地图方法研究 Riemann 曲面自同构,进而对其进行组合推广的一篇文章,曾在“第二届中国科学院博士后前沿与交叉学科学术论坛”上进行交流,是组合方法应用于经典数学领域的一篇文章。这篇文章直接促成了作者在专著 **Automorphism groups of maps, surfaces and Smarandache geometries** 中提出了数学组合化猜想和数十个经典数学结论的组合化问题。

“**我的数学之路**”是为勉励青年学生,在四川省万源市中学面向全校师生报告的一篇文章。文中详细回顾了作者由一个建筑工人,经过刻苦自学,历经委培生、建筑技术管理人员、博士生和博士后研究人员的全过程以及过程中与国内外数学家的交往。文中还回顾了作者提出数学组合化猜想的起因及国际一些研究小组对作者研究工作的关注等事项。

科学的思想是开放的,无禁锢的;科学家在科学问题的研究上是平等的、自由的,无权威还是普通研究人员之等级区分;科学论文的发表是自由的,不能人为设置障碍,或仅因审稿人喜好而拒绝论文的发表,不能依论文的 SCI、EI 等检索对其进行等级评判;同时科学研究要遵守人类社会的道德观,不能从事那些反人类的、有悖于人类道德的研究,这是每一位科学工作者的权利与义务。

美国《物理进展》学报的主编 Dimtri Rabounski 教授新近在其主编的学报上连续两期分别采用英文和法文发表了一篇公开信 **Declaration of Academic Freedom: Scientific Human Rights**, 详细阐述了上述观点,这是科学研究进入二十一世纪和建立自然和人类社会协调发展、共同进步的前提,也是二十一世纪数学自身发展和其服务于人类社会的必经之路。

《二十一世纪数学论文集》将作为系列丛书陆续出版,欢迎广大数学工作者踊跃投稿,尤其是下列六个领域的数学论文:

- (1) 与图论及组合论度量化相关或数学组合化相关的论文;
- (2) 重空间理论,包括代数重空间、度量重空间、非欧几何、现代微分几何等相关的组合问题及论文;
- (3) 拓扑图论、地图理论及其在数学、物理领域的应用;

- (4) 广义相对论及其在宇宙物理学中的应用；
- (5) 弦理论/M-理论中的数学理论；
- (6) 宇宙创生的其他模型及其数学理论等。

所有来稿可以通过电子邮件/信函信件方式直接送达我本人。通讯地址：北京市海淀区中关村中国科学院数学与系统科学研究院，邮政编码：100080。

电子信箱: maolinfan@163.com。

毛林繁

二〇〇六年八月于北京

Preface

As a powerful tool, also a useful language, mathematics has become a scientific foundation for realizing or finding new laws in the natural world. This characteristic implies that a more important task for mathematics is to bring benefit to mankind by applying mathematics to or establishing new mathematical systems for solving various mathematical problems in sciences or the natural world.

Solving problems by applying the mathematical method is the center of mathematics. As we known, these 23 problems asked by Hilbert in the beginning of the 20th century have produced more power for the development of mathematics in last century, and the unified field theory initiated by Einstein in his later years advanced the theoretical physics and helped to bring about the string/M-theory in 80s of the 20th century, which increases the ability of human beings to comprehend the universe.

Sciences are developing, also advancing. A true conclusion in one time maybe a falsehood in another time. Whence, that thinking sciences is an absolutely truth is not right, which includes the mathematics. Modern sciences are so advanced getting into the 21st century that to find a universal genus in the society of sciences is nearly impossible. Thereby a mathematician can only give his or her contribution in one or several mathematical fields. The frequent crossing and combination of different subjects of sciences have become a main trend in realizing our natural world because our natural world itself is overlapping and combinatorial. In this situation, to make the combination of different branches of the classical mathematics so that it can bring benefit to mankind and scientific research is a burning issue of the moment.

What is the mathematics of the 21st century? The mathematics of the 21st century is the combinatorization with its generalization for classical mathematics,

also the result for mathematics consistency with the scientific research in the 21st century. In the mathematics of 21st century, we can encounter some incorrect conclusions in classical mathematics maybe true in this time, and even a claim with its non-claim are true simultaneously in a new mathematical system.

For introducing the combinatorization for classical mathematics, this collection contains 10 papers finished by the author or the author with other mathematicians. All these papers have been published in an e-print form on the internet unless two papers, one reported at “*The Symposia of 2004 Postdoctoral Forum on Frontal & Interdisciplinary Sciences of Chinese Academy of Sciences, Dec. 2004, Beijing*”, another reported at “*The 2005 International Conference on Graph Theory and Combinatorics of China, June, 2005, Zhejiang*”.

Now we outline contents in each paper.

The “**Combinatorial speculations and the combinatorial conjecture for mathematics**” is a survey paper submitted to “*The 2th Conference on Graph Theory and Combinatorics of China*”. This paper introduces the idea of combinatorial conjecture for mathematics and the contributions of combinatorial speculations to mathematics such as those of algebra and geometries and to combinatorial cosmoses, particularly for 5 or 6-dimensional cosmos based on the materials in my two monographs published recently, i.e., **Automorphism groups of maps, surfaces and Smarandache geometries** (American Research Press, 2005) and **Smarandache multi-space theory** (Hexis, America, 2006).

“**The mathematics of 21st century aroused by theoretical physics-Smarandache multi-space theory**” is a paper for introducing the background, approaches and results appeared in mathematics of the 21st century, such as those of Big Bang in cosmological physics, Smarandache multi-spaces, Smarandache geometries, maps, map geometries and pseudo-metric space geometries, also includes discussion for some open problems in theoretical physics. This paper is reported to teachers and students of Wanyuan School in Mar. 2006, also a paper submitted to “*The 2th Conference on Graph Theory and Combinatorics of China*”.

“**A new view of combinatorial maps by Smarandache’s notion**” is a speculation paper for combinatorial maps by applying that of Smarandache’s notion, reported at the *Chinese Academy of Mathematics and System Science* and the *Department of Applied Mathematics of Beijing Jiaotong University* in May, 2005.

This paper firstly introduces the conception of *map geometries*, which are generalization of these 2-dimensional Smarandache manifolds defined by Dr.Iseri, also includes some elementary properties and classification for map geometries. Open problems for the combinatorization of some results in classical mathematics are also given in the final section of this paper, which are benefit for mathematicians researching or wish researching the combinatorization problem for classical mathematics.

“An introduction to Smarandache geometries on maps” is a survey paper reported at *“The 2005 International Conference on Graph Theory and Combinatorics of China”*. This paper introduces maps, map geometries, particularly the necessary and sufficient conditions for parallel bundles in planar map geometries, which are generalized works for the 5th postulate in Euclid plane geometry.

“A multi-space model for Chinese bid evaluation with analyzing” and **“A mathematical model for Chinese bid evaluation with its solution analyzing”** are two papers coped with the suggestion of Dr.Perze, the editor of American Research Press after I published a Chinese book **Chinese Construction Project Bidding Technique & Cases Analyzing-Smarandache Multi-Space Model of Bidding** in Xiquan Publishing House (2006). These papers firstly constructed a mathematical model for bids evaluation system, pointed out that it is a decision problem for finite multiple objectives under the law and regulations system for tendering, also gave a graphical method for analyzing the order of bids. Some open problems for weighted Smarandache multi-spaces and suggestions for solving problems existed in current bids evaluation system in China are presented in the final section.

“The number of complete maps on surfaces” and **“On automorphisms and enumeration of maps of Cayley graphs of a finite group”** are two papers finished in May, 2004 and Nov. 2001. Applying the group action idea, these papers enumerate the unrooted complete maps and non-equivalent maps underlying a Cayley graph of a finite group on orientable and non-orientable surfaces, which generalize a scheme for enumerating non-equivalent embeddings of a graph presented by White et.al. They are applications of classical mathematics to combinatorics.

“A combinatorial refinement of Hurwitz theorem on Riemann Surfaces” is a paper by applying combinatorial maps to determine automorphisms of Riemann surfaces and getting combinatorial refinement for some classical results.

This paper is submitted to “*The Symposia of 2004 Postdoctoral Forum on Frontal & Interdisciplinary Sciences of Chinese Academy of Sciences*”. It is the applications of combinatorics to classical mathematics. It is due to this paper that I presented the combinatorial conjecture for mathematics and open combinatorial problems for Riemann surfaces, Riemann geometry, differential geometry and Riemann manifolds in my monograph **Automorphism groups of maps, surfaces and Smarandache geometries**.

“**The mathematical steps of mine**” is a paper for encouraging young teachers and students, reported at my old school *Sichuan Wanyuan school* in Mar. 2006. This paper historically recalls each step that I passed from a scaffold erector to a mathematician, including the period in *Wanyuan school*, in a construction company, in *Northern Jiaotong University*, in *Chinese Academy of Sciences* and in *Guoxin Tendering Co.LTD*. The social contact of mine with some mathematicians and the process for raising the combinatorial conjecture for mathematics is also called to mind.

Certainly, there are rights and obligations for a scientist such as those of

the choice of research theme and research methods is freedom without limitation; all scientists are equal before research themes regardless their position in our society; to participate and publish scientific results is freedom, can not be rejected if the results disagrees with or contradicts preferred theory or not favor with the editors, the referees, or other expert censors; every scientist bears a moral responsibility in her or his research, can not allow her/his research work injurious to mankind.

Recently, Prof. Dimtri Rabounski, the chief editor of “**Progress in Physics**”, issued an open letter **Declaration of academic freedom: scientific human rights** in Vol. 1,2006, to clarify those opinions for scientific research. This is a precondition for sciences in the 21st century and the harmonizing development of the human society with the natural world, also an indispensable path for developing mathematics of 21st century and bringing benefit to mankind by mathematics.

The “**Mathematics of 21st Century—A Collection of Selected Papers**” is a serial collections in publication. Papers on the following 6 fields are welcome.

(1) *Metrization of graphs and combinatorics, or the combinatorization for classical mathematics;*

- (2) *Multi-spaces, including algebraic multi-spaces, multi-metric spaces, non-Euclid geometry, modern differential geometry;*
- (3) *Topological graphs and combinatorial maps with applications in mathematics and physics;*
- (4) *General relativity theory with its applications to cosmological physics;*
- (5) *Mathematics theory in string/M-theory;*
- (6) *Other new models for the universe and its mathematical theory.*

All these submitted papers can be directly sent to me by email or by post. My email address is: “*maolinfan@163.com*” and my post address is “*Academy of Mathematics and Systems, Chinese Academy of Sciences, Beijing 100080, P.R.China*” .

L.F.Mao

Aug. 2006 in Beijing

Contents

Preface	i
1. Combinatorial speculations and the combinatorial conjecture for mathematics 1 组合思想与数学组合化猜想	1
2. 理论物理引发的二十一世纪数学 -Smarandache 重空间理论	24
The mathematics of 21st century aroused by theoretical physics	24
3. A new view of combinatorial maps by Smarandache's notion	47
Smarandache 思想引发的组合地图研究方向	47
4. An introduction to Smarandache geometries on maps	73
地图上的 Smarandache 几何引论	73
5. A multi-space model for Chinese bid evaluation with analyzing	84
招标评价体系的重空间模型及求解分析	84
6. 招标评价体系的数学模型及求解分析	106
A mathematical model for Chinese bid evaluation with its solution analyzing ..	104
7. The number of complete maps on surfaces	122
曲面完全地图的计数	122
8. Automorphisms and enumeration of maps of Cayley graphs of a finite group	147
基础图为有限群的 Cayley 图的地图的自同构及其计数	147

9. Riemann 曲面上 Hurwitz 定理得组合推广	167
A combinatorial refinement of Hurwitz theorem on Riemann Surfaces.....	167
10. 我的数学之路	183
The mathematical steps of mine.....	183
About the author	202

21math-001-001



Combinatorial Speculations and the Combinatorial Conjecture for Mathematics*

Linfan Mao

(Chinese Academy of Mathematics and System Sciences, Beijing 100080)

maolinfan@163.com

Abstract: Combinatorics is a powerful tool for dealing with relations among objectives mushroomed in the past century. However, an even more important work for mathematician is to apply combinatorics to other mathematics and other sciences beside just to find combinatorial behavior for objectives. In the past few years, works of this kind frequently appeared on journals for mathematics and theoretical physics for cosmos. The main purpose of this paper is to survey these thinking and ideas for mathematics and cosmological physics, such as those of multi-spaces, map geometries and combinatorial cosmoses, also the combinatorial conjecture for mathematics proposed by myself in 2005. Some open problems are included for the advance of 21st mathematics by a combinatorial speculation.

组合思想及数学组合化猜想

摘要. 作为处理客体之间相互关系的有效工具，组合数学在二十世纪的到了突飞猛进的发展，但对数学工作者来说，一项更重要的工作是将组合数学应用于其他数学分支和其他科学而不是仅局限于发现客体之间的

¹Reported at *the 2th Conference on Combinatorics and Graph Theory of China*, Aug. 16-19, 2006, Tianjing, P.R.China

²e-print: *arXiv*: math.GM/0606702 and *Sciencepaper Online*:200607-128

组合性质。采用这种思想对数学及宇宙物理学的研究工作近年来经常出现在一些学术刊物上。本文的主要目的，在于综述已经出现在数学与宇宙物理学研究中的组合思想，诸如重空间、地图几何、组合宇宙等等，同时讨论作者在 2005 年提出数学组合化猜想。文中还包括由组合思想对 21 世纪数学发展提出的一些需要研究和解决的问题。

Key words: combinatorial speculation, combinatorial conjecture for mathematics, Smarandache multi-space, M-theory, combinatorial cosmos.

Classification: AMS(2000) 03C05,05C15,51D20,51H20,51P05,83C05,83E50.

1. The role of classical combinatorics in mathematics

Modern science has so advanced that to find a universal genus in the society of sciences is nearly impossible. Thereby a scientist can only give his or her contribution in one or several fields. The same thing also happens for researchers in combinatorics. Generally, combinatorics deals with twofold:

Question 1.1. *to determine or find structures or properties of configurations, such as those structure results appeared in graph theory, combinatorial maps and design theory,..., etc..*

Question 1.2. *to enumerate configurations, such as those appeared in the enumeration of graphs, labelled graphs, rooted maps, unrooted maps and combinatorial designs,...,etc..*

Consider the contribution of a question to science. We can separate mathematical questions into three ranks:

Rank 1 *they contribute to all sciences.*

Rank 2 *they contribute to all or several branches of mathematics.*

Rank 3 *they contribute only to one branch of mathematics, for instance, just to the graph theory or combinatorial theory.*

Classical combinatorics is just a *rank 3 mathematics* by this view. This conclusion is despair for researchers in combinatorics, also for me 4 years ago. *Whether can combinatorics be applied to other mathematics or other sciences? Whether can it contribute to human's lives, not just in games?*

Although become a universal genius in science is nearly impossible, *our world is a combinatorial world*. A combinatorician should stand on all mathematics and all sciences, not just on classical combinatorics and with a real combinatorial notion, i.e., *combining different fields into a unifying field* ([25]-[28]), such as combine different or even anti branches in mathematics or science into a unifying science for its freedom of research ([24]). This notion requires us answering three questions for solving a combinatorial question before. *What is this question working for? What is its objective? What is its contribution to science or human's society?* After these works be well done, modern combinatorics can applied to all sciences and all sciences are combinatorization.

2. The combinatorics metrization and mathematics combinatorization

There is a prerequisite for the application of combinatorics to other mathematics and other sciences, i.e, to introduce various metrics into combinatorics, ignored by the classical combinatorics since they are the fundamental of scientific realization for our world. This speculation is firstly appeared in the beginning of Chapter 5 of my book [16]:

... our world is full of measures. For applying combinatorics to other branch of mathematics, a good idea is pullback measures on combinatorial objects again, ignored by the classical combinatorics and reconstructed or make combinatorial generalization for the classical mathematics, such as those of algebra, differential geometry, Riemann geometry, Smarandache geometries, ... and the mechanics, theoretical physics, ...

The combinatorial conjecture for mathematics, abbreviated to *CCM* is stated in the following.

Conjecture 2.1(CCM Conjecture) *Mathematics can be reconstructed from or made by combinatorization.*

Remark 2.1 We need some further clarifications for this conjecture.

(i) This conjecture assumes that one can select finite combinatorial rulers and axioms to reconstruct or make generalization for classical mathematics.

(ii) Classical mathematics is a particular case in the combinatorization of mathematics, i.e., the later is a combinatorial generalization of the former.

(iii) We can make one combinatorization of different branches in mathematics and find new theorems after then.

Therefore, a branch in mathematics can not be ended if it has not been combinatorization and all mathematics can not be ended if its combinatorization has not completed. There is an assumption in one's realization of our world, i.e., *every science can be made mathematization*. Whence, we similarly get the combinatorial conjecture for science.

Conjecture 2.2(CCS Conjecture) *Science can be reconstructed from or made by combinatorization.*

A typical example for the combinatorization of classical mathematics is the *combinatorial map theory*, i.e., a combinatorial theory for surfaces([14]-[15]). Combinatorially, a surface is topological equivalent to a polygon with even number of edges by identifying each pairs of edges along a given direction on it. If label each pair of edges by a letter $e, e \in \mathcal{E}$, a surface S is also identifying to a cyclic permutation such that each edge $e, e \in \mathcal{E}$ just appears two times in S , one is e and another is e^{-1} . Let a, b, c, \dots denote the letters in \mathcal{E} and A, B, C, \dots the sections of successive letters in a linear order on a surface S (or a string of letters on S). Then, a surface can be represented as follows:

$$S = (\dots, A, a, B, a^{-1}, C, \dots),$$

where, $a \in \mathcal{E}, A, B, C$ denote a string of letters. Define three elementary transformations as follows:

$$(O_1) \quad (A, a, a^{-1}, B) \Leftrightarrow (A, B);$$

$$(O_2) \quad (i) \quad (A, a, b, B, b^{-1}, a^{-1}) \Leftrightarrow (A, c, B, c^{-1});$$

$$(ii) \quad (A, a, b, B, a, b) \Leftrightarrow (A, c, B, c);$$

$$(O_3) \quad (i) \quad (A, a, B, C, a^{-1}, D) \Leftrightarrow (B, a, A, D, a^{-1}, C);$$

$$(ii) \quad (A, a, B, C, a, D) \Leftrightarrow (B, a, A, C^{-1}, a, D^{-1}).$$

If a surface S can be obtained from S_0 by these elementary transformations

O_1 - O_3 , we say that S is elementary equivalent with S_0 , denoted by $S \sim_{El} S_0$. Then we can get the classification theorem of compact surface as follows([29]):

Any compact surface is homeomorphic to one of the following standard surfaces:

(P_0) the sphere: aa^{-1} ;

(P_n) the connected sum of $n, n \geq 1$ tori:

$$a_1b_1a_1^{-1}b_1^{-1}a_2b_2a_2^{-1}b_2^{-1} \cdots a_nb_na_n^{-1}b_n^{-1};$$

(Q_n) the connected sum of $n, n \geq 1$ projective planes:

$$a_1a_1a_2a_2 \cdots a_na_n.$$

A map M is a connected topological graph cellularly embedded in a surface S . In 1973, Tutte suggested an algebraic representation for an embedding graph on a locally orientable surface ([16]):

A *combinatorial map* $M = (\mathcal{X}_{\alpha,\beta}, \mathcal{P})$ is defined to be a basic permutation \mathcal{P} , i.e, for any $x \in \mathcal{X}_{\alpha,\beta}$, no integer k exists such that $\mathcal{P}^k x = \alpha x$, acting on $\mathcal{X}_{\alpha,\beta}$, the disjoint union of *quadrancells* Kx of $x \in X$ (the base set), where $K = \{1, \alpha, \beta, \alpha\beta\}$ is the *Klein group* satisfying the following two conditions:

(i) $\alpha\mathcal{P} = \mathcal{P}^{-1}\alpha$;

(ii) the group $\Psi_J = \langle \alpha, \beta, \mathcal{P} \rangle$ is transitive on $\mathcal{X}_{\alpha,\beta}$.

For a given map $M = (\mathcal{X}_{\alpha,\beta}, \mathcal{P})$, it can be shown that $M^* = (\mathcal{X}_{\beta,\alpha}, \mathcal{P}\alpha\beta)$ is also a map, call it the *dual* of the map M . The vertices of M are defined as the pairs of conjugatecy orbits of \mathcal{P} action on $\mathcal{X}_{\alpha,\beta}$ by the condition (i) and edges the orbits of K on $\mathcal{X}_{\alpha,\beta}$, for example, for $\forall x \in \mathcal{X}_{\alpha,\beta}$, $\{x, \alpha x, \beta x, \alpha\beta x\}$ is an edge of the map M . Define the faces of M to be the vertices in the dual map M^* . Then the Euler characteristic $\chi(M)$ of the map M is

$$\chi(M) = \nu(M) - \varepsilon(M) + \phi(M)$$

where, $\nu(M), \varepsilon(M), \phi(M)$ are the number of vertices, edges and faces of the map M , respectively. For each vertex of a map M , its valency is defined to be the length of the orbits of \mathcal{P} action on a quadrancell incident with u .

For example, the graph K_4 on the tours with one face length 4 and another 8 shown in Fig.2.1

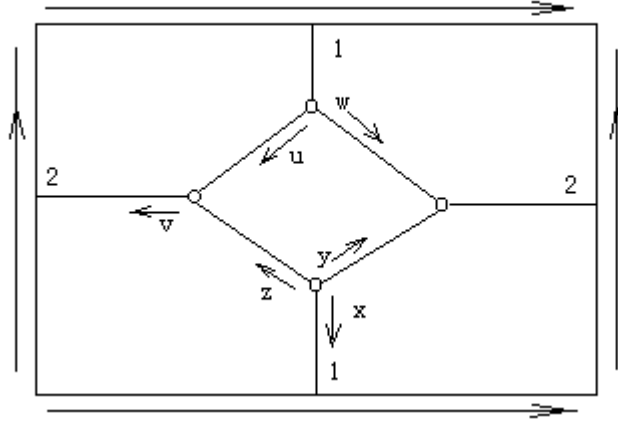

Fig.1. the graph K_4 on the tours

can be algebraically represented by $(\mathcal{X}_{\alpha,\beta}, \mathcal{P})$ with $\mathcal{X}_{\alpha,\beta} = \{x, y, z, u, v, w, \alpha x, \alpha y, \alpha z, \alpha u, \alpha v, \alpha w, \beta x, \beta y, \beta z, \beta u, \beta v, \beta w, \alpha\beta x, \alpha\beta y, \alpha\beta z, \alpha\beta u, \alpha\beta v, \alpha\beta w\}$ and

$$\begin{aligned} \mathcal{P} &= (x, y, z)(\alpha\beta x, u, w)(\alpha\beta z, \alpha\beta u, v)(\alpha\beta y, \alpha\beta v, \alpha\beta w) \\ &\times (\alpha x, \alpha z, \alpha y)(\beta x, \alpha w, \alpha u)(\beta z, \alpha v, \beta u)(\beta y, \beta w, \beta v) \end{aligned}$$

with 4 vertices, 6 edges and 2 faces on an orientable surface of genus 1.

By the view of combinatorial maps, these standard surfaces P_0, P_n, Q_n for $n \geq 1$ is nothing but the bouquet B_n on a locally orientable surface with just one face. Therefore, combinatorial maps are the combinatorization of surfaces.

Many open problems are motivated by the *CCM Conjecture*. For example, a *Gauss mapping* among surfaces is defined as follows.

Let $\mathcal{S} \subset R^3$ be a surface with an orientation \mathbf{N} . The mapping $\mathbf{N} : \mathcal{S} \rightarrow R^3$ takes its value in the unit sphere

$$S^2 = \{(x, y, z) \in R^3 | x^2 + y^2 + z^2 = 1\}$$

along the orientation \mathbf{N} . The map $\mathbf{N} : \mathcal{S} \rightarrow S^2$, thus defined, is called the *Gauss mapping*.

we know that for a point $P \in \mathcal{S}$ such that the Gaussian curvature $K(P) \neq 0$ and V a connected neighborhood of P with K does not change sign,

$$K(P) = \lim_{A \rightarrow 0} \frac{N(A)}{A},$$

where A is the area of a region $B \subset V$ and $N(A)$ is the area of the image of B by the Gauss mapping $N : \mathcal{S} \rightarrow S^2([2],[4])$. Now the questions are

- (i) *what is its combinatorial meaning of the Gauss mapping? How to realizes it by combinatorial maps?*
- (ii) *how can we define various curvatures for maps and rebuilt the results in the classical differential geometry?*

Let \mathcal{S} be a compact orientable surface. Then the *Gauss-Bonnet theorem* asserts that

$$\int \int_{\mathcal{S}} K d\sigma = 2\pi\chi(\mathcal{S}),$$

where K is the Gaussian curvature of \mathcal{S} .

By the *CCM Conjecture*, the following questions should be considered.

- (i) *How can we define various metrics for combinatorial maps, such as those of length, distance, angle, area, curvature,...*
- (ii) *Can we rebuilt the Gauss-Bonnet theorem by maps for dimensional 2 or higher dimensional compact manifolds without boundary?*

One can see references [15] and [16] for more open problems for the classical mathematics motivated by this *CCM Conjecture*, also raise new open problems for his or her research works.

3. The contribution of combinatorial speculation to mathematics

3.1. The combinatorization of algebra

By the view of combinatorics, algebra can be seen as a combinatorial mathematics itself. The combinatorial speculation can generalize it by the means of combinatorization. For this objective, a Smarandache multi-algebraic system is combinatorially defined in the following definition.

Definition 3.1([17],[18]) *For any integers $n, n \geq 1$ and $i, 1 \leq i \leq n$, let A_i be a set with an operation set $O(A_i)$ such that $(A_i, O(A_i))$ is a complete algebraic system. Then the union*

$$\bigcup_{i=1}^n (A_i, O(A_i))$$

is called an n multi-algebra system.

An example of multi-algebra system is constructed by a finite additive group. Now let n be an integer, $Z_1 = (\{0, 1, 2, \dots, n-1\}, +)$ an additive group ($\text{mod } n$) and $P = (0, 1, 2, \dots, n-1)$ a permutation. For any integer $i, 0 \leq i \leq n-1$, define

$$Z_{i+1} = P^i(Z_1)$$

satisfying that if $k + l = m$ in Z_1 , then $P^i(k) +_i P^i(l) = P^i(m)$ in Z_{i+1} , where $+_i$ denotes the binary operation $+_i : (P^i(k), P^i(l)) \rightarrow P^i(m)$. Then we know that

$$\bigcup_{i=1}^n Z_i$$

is an n multi-algebra system .

The conception of multi-algebra systems can be extensively used for generalizing conceptions and results in the algebraic structure, such as those of groups, rings, bodies, fields and vector spaces, \dots , etc.. Some of them are explained in the following.

Definition 3.2 *Let $\tilde{G} = \bigcup_{i=1}^n G_i$ be a complete multi-algebra system with a binary operation set $O(\tilde{G}) = \{\times_i, 1 \leq i \leq n\}$. If for any integer $i, 1 \leq i \leq n$, $(G_i; \times_i)$ is a group and for $\forall x, y, z \in \tilde{G}$ and any two binary operations “ \times ” and “ \circ ”, $\times \neq \circ$, there is one operation, for example the operation \times satisfying the distribution law to the operation “ \circ ” provided their operation results exist , i.e.,*

$$x \times (y \circ z) = (x \times y) \circ (x \times z),$$

$$(y \circ z) \times x = (y \times x) \circ (z \times x),$$

then \tilde{G} is called a multi-group.

For a multi-group $(\tilde{G}, O(G))$, $\tilde{G}_1 \subset \tilde{G}$ and $O(\tilde{G}_1) \subset O(\tilde{G})$, call $(\tilde{G}_1, O(\tilde{G}_1))$ a *sub-multi-group* of $(\tilde{G}, O(G))$ if \tilde{G}_1 is also a multi-group under the operations in $O(\tilde{G}_1)$, denoted by $\tilde{G}_1 \preceq \tilde{G}$. For two sets A and B , if $A \cap B = \emptyset$, we denote the union $A \cup B$ by $A \oplus B$. Then we get a generalization of the *Lagrange theorem* of finite group.

Theorem 3.1([18]) *For any sub-multi-group \tilde{H} of a finite multi-group \tilde{G} , there is a representation set T , $T \subset \tilde{G}$, such that*

$$\tilde{G} = \bigoplus_{x \in T} x\tilde{H}.$$

For a sub-multi-group \tilde{H} of \tilde{G} , $\times \in O(\tilde{H})$ and $\forall g \in \tilde{G}(\times)$, if for $\forall h \in \tilde{H}$,

$$g \times h \times g^{-1} \in \tilde{H},$$

then call \tilde{H} a *normal sub-multi-group* of \tilde{G} . An order of operations in $O(\tilde{G})$ is said an *oriented operation sequence*, denoted by $\vec{O}(\tilde{G})$. We get a generalization of the *Jordan-Hölder theorem* for finite multi-groups.

Theorem 3.2([18]) *For a finite multi-group $\tilde{G} = \bigcup_{i=1}^n G_i$ and an oriented operation sequence $\vec{O}(\tilde{G})$, the length of maximal series of normal sub-multi-groups is a constant, only dependent on \tilde{G} itself.*

In Definition 2.2, choose $n = 2$, $G_1 = G_2 = \tilde{G}$. Then \tilde{G} is a body. If $(G_1; \times_1)$ and $(G_2; \times_2)$ both are commutative groups, then \tilde{G} is a field. For multi-algebra system with two or more operations on one set, we introduce the conception of multi-rings and multi-vector spaces in the following.

Definition 3.3 *Let $\tilde{R} = \bigcup_{i=1}^m R_i$ be a complete multi-algebra system with double binary operation set $O(\tilde{R}) = \{(+_i, \times_i), 1 \leq i \leq m\}$. If for any integers i, j , $i \neq j$, $1 \leq i, j \leq m$, $(R_i; +_i, \times_i)$ is a ring and for $\forall x, y, z \in \tilde{R}$,*

$$(x +_i y) +_j z = x +_i (y +_j z), \quad (x \times_i y) \times_j z = x \times_i (y \times_j z)$$

and

$$x \times_i (y +_j z) = x \times_i y +_j x \times_i z, \quad (y +_j z) \times_i x = y \times_i x +_j z \times_i x$$

provided all their operation results exist, then \tilde{R} is called a multi-ring. If for any integer $1 \leq i \leq m$, $(R; +_i, \times_i)$ is a filed, then \tilde{R} is called a multi-filed.

Definition 3.4 Let $\tilde{V} = \bigcup_{i=1}^k V_i$ be a complete multi-algebra system with binary operation set $O(\tilde{V}) = \{(\dot{+}_i, \cdot_i) \mid 1 \leq i \leq m\}$ and $\tilde{F} = \bigcup_{i=1}^k F_i$ a multi-filed with double binary operation set $O(\tilde{F}) = \{(+_i, \times_i) \mid 1 \leq i \leq k\}$. If for any integers i, j , $1 \leq i, j \leq k$ and $\forall \mathbf{a}, \mathbf{b}, \mathbf{c} \in \tilde{V}$, $k_1, k_2 \in \tilde{F}$,

(i) $(V_i; \dot{+}_i, \cdot_i)$ is a vector space on F_i with vector additive $\dot{+}_i$ and scalar multiplication \cdot_i ;

$$(ii) (\mathbf{a} \dot{+}_i \mathbf{b}) \dot{+}_j \mathbf{c} = \mathbf{a} \dot{+}_i (\mathbf{b} \dot{+}_j \mathbf{c});$$

$$(iii) (k_1 +_i k_2) \cdot_j \mathbf{a} = k_1 +_i (k_2 \cdot_j \mathbf{a});$$

provided all those operation results exist, then \tilde{V} is called a multi-vector space on the multi-filed \tilde{F} with a binary operation set $O(\tilde{V})$, denoted by $(\tilde{V}; \tilde{F})$.

Similar to multi-groups, we can also obtain results for multi-rings and multi-vector spaces to generalize classical results in rings or linear spaces. Certainly, results can be also found in the references [17] and [18].

3.2. The combinatorization of geometries

First, we generalize classical metric spaces by the combinatorial speculation.

Definition 3.5 A multi-metric space is a union $\tilde{M} = \bigcup_{i=1}^m M_i$ such that each M_i is a space with metric ρ_i for $\forall i, 1 \leq i \leq m$.

We generalized two well-known results in metric spaces.

Theorem 3.3([19]) Let $\tilde{M} = \bigcup_{i=1}^m M_i$ be a completed multi-metric space. For an ϵ -disk sequence $\{B(\epsilon_n, x_n)\}$, where $\epsilon_n > 0$ for $n = 1, 2, 3, \dots$, the following conditions hold:

$$(i) B(\epsilon_1, x_1) \supset B(\epsilon_2, x_2) \supset B(\epsilon_3, x_3) \supset \dots \supset B(\epsilon_n, x_n) \supset \dots;$$

$$(ii) \lim_{n \rightarrow +\infty} \epsilon_n = 0.$$

Then $\bigcap_{n=1}^{+\infty} B(\epsilon_n, x_n)$ only has one point.

Theorem 3.4([19]) Let $\widetilde{M} = \bigcup_{i=1}^m M_i$ be a completed multi-metric space and T a contraction on \widetilde{M} . Then

$$1 \leq \# \Phi(T) \leq m.$$

Particularly, let $m = 1$. We get the *Banach fixed-point theorem* again.

Corollary 3.1(Banach) Let M be a metric space and T a contraction on M . Then T has just one fixed point.

Smarandache geometries were proposed by Smarandache in [25] which are generalization of classical geometries, i.e., these *Euclid*, *Lobachevshy-Bolyai-Gauss* and *Riemann geometries* may be united altogether in a same space, by some Smarandache geometries under the combinatorial speculation. These geometries can be either partially Euclidean and partially Non-Euclidean, or Non-Euclidean. In general, Smarandache geometries are defined in the next.

Definition 3.6 An axiom is said to be *Smarandachely denied* if the axiom behaves in at least two different ways within the same space, i.e., validated and invalidated, or only invalidated but in multiple distinct ways.

A *Smarandache geometry* is a geometry which has at least one *Smarandachely denied axiom*(1969).

For example, let us consider an euclidean plane \mathbf{R}^2 and three non-collinear points A, B and C . Define s -points as all usual euclidean points on \mathbf{R}^2 and s -lines as any euclidean line that passes through one and only one of points A, B and C . Then this geometry is a Smarandache geometry because two axioms are Smarandachely denied comparing with an Euclid geometry:

(i) The axiom (A5) that through a point exterior to a given line there is only one parallel passing through it is now replaced by two statements: *one parallel* and *no parallel*. Let L be an s -line passing through C and is parallel in the euclidean sense to AB . Notice that through any s -point not lying on AB there is one s -line parallel to L and through any other s -point lying on AB there is no s -lines parallel

to L such as those shown in Fig.3.1(a).

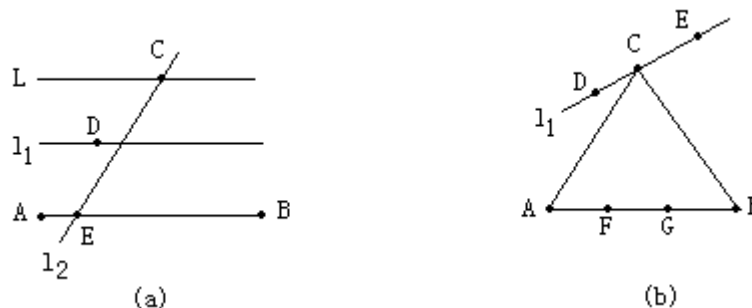

Fig.2. an example of Smarandache geometry

(ii) The axiom that through any two distinct points there exists one line passing through them is now replaced by; *one s-line and no s-line*. Notice that through any two distinct s -points D, E collinear with one of A, B and C , there is one s -line passing through them and through any two distinct s -points F, G lying on AB or non-collinear with one of A, B and C , there is no s -line passing through them such as those shown in Fig.3.1(b).

A *Smarandache n -manifold* is an n -dimensional manifold that support a Smarandache geometry. Now there are many approaches to construct Smarandache manifolds for $n = 2$. A general way is by the so called *map geometries* without or with boundary underlying orientable or non-orientable maps proposed in references [14] and [15] firstly.

Definition 3.7 For a combinatorial map M with each vertex valency ≥ 3 , associates a real number $\mu(u), 0 < \mu(u) < \frac{4\pi}{\rho_M(u)}$, to each vertex $u, u \in V(M)$. Call (M, μ) a map geometry without boundary, $\mu(u)$ an angle factor of the vertex u and orientable or non-orientable if M is orientable or not.

Definition 3.8 For a map geometry (M, μ) without boundary and faces $f_1, f_2, \dots, f_l \in F(M), 1 \leq l \leq \phi(M) - 1$, if $S(M) \setminus \{f_1, f_2, \dots, f_l\}$ is connected, then call $(M, \mu)^{-l} = (S(M) \setminus \{f_1, f_2, \dots, f_l\}, \mu)$ a map geometry with boundary f_1, f_2, \dots, f_l , where $S(M)$ denotes the locally orientable surface underlying map M .

The realization for vertices $u, v, w \in V(M)$ in a space \mathbf{R}^3 is shown in Fig.3.2, where $\rho_M(u)\mu(u) < 2\pi$ for the vertex u , $\rho_M(v)\mu(v) = 2\pi$ for the vertex v and $\rho_M(w)\mu(w) > 2\pi$ for the vertex w , are called to be elliptic, euclidean or hyperbolic,

respectively.

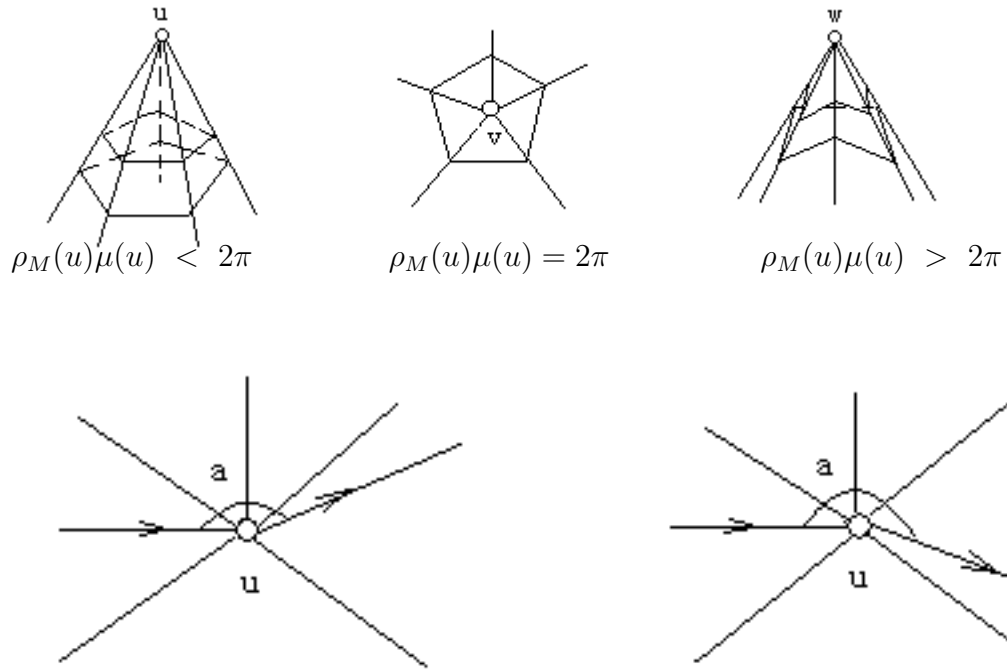

Fig.4. a straight line passes through an elliptic or hyperbolic point

Theorem 3.5([17]) *There are Smarandache geometries, including paradoxist geometries, non-geometries and anti-geometries in map geometries without or with boundary.*

Generally, we can ever generalize the ideas in Definitions 3.7 and 3.8 to a metric space and find new geometries.

Definition 3.9 *Let U and W be two metric spaces with metric ρ , $W \subseteq U$. For $\forall u \in U$, if there is a continuous mapping $\omega : u \rightarrow \omega(u)$, where $\omega(u) \in \mathbf{R}^n$ for an integer $n, n \geq 1$ such that for any number $\epsilon > 0$, there exists a number $\delta > 0$ and a point $v \in W$, $\rho(u - v) < \delta$ such that $\rho(\omega(u) - \omega(v)) < \epsilon$, then U is called a metric pseudo-space if $U = W$ or a bounded metric pseudo-space if there is a number $N > 0$ such that $\forall w \in W$, $\rho(w) \leq N$, denoted by (U, ω) or (U^-, ω) , respectively.*

For the case $n = 1$, we can also explain $\omega(u)$ being an angle function with

$0 < \omega(u) \leq 4\pi$ as in the case of map geometries without or with boundary, i.e.,

$$\omega(u) = \begin{cases} \omega(u)(\text{mod}4\pi), & \text{if } u \in W, \\ 2\pi, & \text{if } u \in U \setminus W \end{cases} \quad (*)$$

and get some interesting metric pseudo-space geometries. For example, let $U = W = \text{Euclid plane} = \Sigma$, then we obtained some interesting results for pseudo-plane geometries (Σ, ω) as shown in the following([17]).

Theorem 3.6 *In a pseudo-plane (Σ, ω) , if there are no euclidean points, then all points of (Σ, ω) is either elliptic or hyperbolic.*

Theorem 3.7 *There are no saddle points and stable knots in a pseudo-plane plane (Σ, ω) .*

Theorem 3.8 *For two constants ρ_0, θ_0 , $\rho_0 > 0$ and $\theta_0 \neq 0$, there is a pseudo-plane (Σ, ω) with*

$$\omega(\rho, \theta) = 2\left(\pi - \frac{\rho_0}{\theta_0\rho}\right) \text{ or } \omega(\rho, \theta) = 2\left(\pi + \frac{\rho_0}{\theta_0\rho}\right)$$

such that

$$\rho = \rho_0$$

is a limiting ring in (Σ, ω) .

Now for an m -manifold M^m and $\forall u \in M^m$, choose $U = W = M^m$ in Definition 3.9 for $n = 1$ and $\omega(u)$ a smooth function. We get a pseudo-manifold geometry (M^m, ω) on M^m . By definitions in the reference [2], a *Minkowski norm* on M^m is a function $F : M^m \rightarrow [0, +\infty)$ such that

- (i) F is smooth on $M^m \setminus \{0\}$;
- (ii) F is 1-homogeneous, i.e., $F(\lambda\bar{u}) = \lambda F(\bar{u})$ for $\bar{u} \in M^m$ and $\lambda > 0$;
- (iii) for $\forall y \in M^m \setminus \{0\}$, the symmetric bilinear form $g_y : M^m \times M^m \rightarrow R$ with

$$g_y(\bar{u}, \bar{v}) = \frac{1}{2} \frac{\partial^2 F^2(y + s\bar{u} + t\bar{v})}{\partial s \partial t} \Big|_{t=s=0}$$

is positive definite and a *Finsler manifold* is a manifold M^m endowed with a function $F : TM^m \rightarrow [0, +\infty)$ such that

- (i) F is smooth on $TM^m \setminus \{0\} = \cup\{T_{\bar{x}}M^m \setminus \{0\} : \bar{x} \in M^m\}$;
- (ii) $F|_{T_{\bar{x}}M^m} \rightarrow [0, +\infty)$ is a Minkowski norm for $\forall \bar{x} \in M^m$.

As a special case, we choose $\omega(\bar{x}) = F(\bar{x})$ for $\bar{x} \in M^m$, then (M^m, ω) is a *Finsler manifold*. Particularly, if $\omega(\bar{x}) = g_{\bar{x}}(y, y) = F^2(x, y)$, then (M^m, ω) is a *Riemann manifold*. Therefore, we get a relation for Smarandache geometries with Finsler or Riemann geometry.

Theorem 3.9 *There is an inclusion for Smarandache, pseudo-manifold, Finsler and Riemann geometries as shown in the following:*

$$\begin{aligned} \{\text{Smarandache geometries}\} &\supset \{\text{pseudo - manifold geometries}\} \\ &\supset \{\text{Finsler geometry}\} \\ &\supset \{\text{Riemann geometry}\}. \end{aligned}$$

4. The contribution of combinatorial speculation to theoretical physics

The progress of theoretical physics in last twenty years of the 20th century enables human beings to probe the mystic cosmos: *where are we came from? where are we going to?* Today, these problems still confuse eyes of human beings. Accompanying with research in cosmos, new puzzling problems also arose: *Whether are there finite or infinite cosmoses? Is just one? What is the dimension of our cosmos? We do not even know what the right degree of freedom in the universe is*, as Witten said([3]).

We are used to the idea that our living space has three dimensions: *length, breadth and height*, with time providing the fourth dimension of spacetime by Einstein. Applying his principle of general relativity, i.e. *all the laws of physics take the same form in any reference system* and equivalence principle, i.e., *there are no difference for physical effects of the inertial force and the gravitation in a field small enough.*, Einstein got the *equation of gravitational field*

$$R_{\mu\nu} - \frac{1}{2}Rg_{\mu\nu} + \lambda g_{\mu\nu} = -8\pi GT_{\mu\nu}.$$

where $R_{\mu\nu} = R_{\nu\mu} = R_{\mu\nu}^{\alpha}$,

$$R_{\mu\nu}^{\alpha} = \frac{\partial \Gamma_{\mu\nu}^{\alpha}}{\partial x^{\nu}} - \frac{\partial \Gamma_{\mu\nu}^{\alpha}}{\partial x^{\nu}} + \Gamma_{\mu\nu}^{\alpha} \Gamma_{\alpha\nu}^i - \Gamma_{\mu\nu}^{\alpha} \Gamma_{\alpha i}^{\nu},$$

$$\Gamma_{mn}^g = \frac{1}{2}g^{pq}\left(\frac{\partial g_{mp}}{\partial u^n} + \frac{\partial g_{np}}{\partial u^m} - \frac{\partial g_{mn}}{\partial u^p}\right)$$

and $R = g^{\nu\mu}R_{\nu\mu}$.

Combining the Einstein's equation of gravitational field with the *cosmological principle*, i.e., *there are no difference at different points and different orientations at a point of a cosmos on the metric* $10^{41}.y.$, Friedmann got a standard model of cosmos. The metrics of the standard cosmos are

$$ds^2 = -c^2 dt^2 + a^2(t)\left[\frac{dr^2}{1 - Kr^2} + r^2(d\theta^2 + \sin^2\theta d\varphi^2)\right]$$

and

$$g_{tt} = 1, \quad g_{rr} = -\frac{R^2(t)}{1 - Kr^2}, \quad g_{\phi\phi} = -r^2 R^2(t) \sin^2\theta.$$

The standard model of cosmos enables the birth of big bang model of our cosmos in thirties of the 20th century. The following diagram describes the developing process of our cosmos in different periods after the big bang.

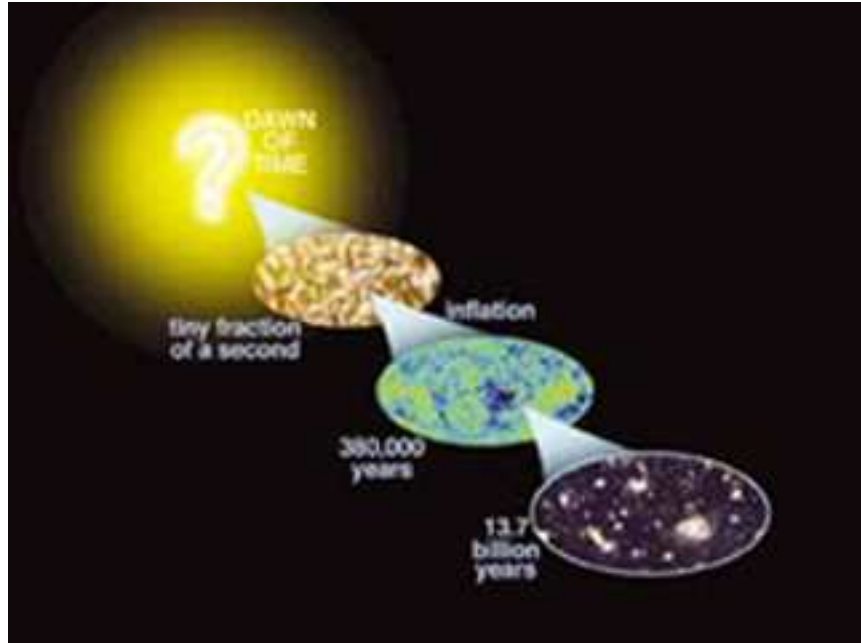

Fig.5. the evolution of our cosmos

4.1. The M-theory

The M-theory was established by Witten in 1995 for the unity of those five already known string theories and superstring theories, which postulates that all matter and energy can be reduced to *branes* of energy vibrating in an 11 dimensional space, then in a higher dimensional space solve the Einstein's equation of gravitational field under some physical conditions ([1],[3],[22]-[23]). Here, a *brane* is an object or subspace which can have various spatial dimensions. For any integer $p \geq 0$, a p -*brane* has length in p dimensions. For example, a 0-*brane* is just a point or particle; a 1-*brane* is a string and a 2-*brane* is a surface or membrane, \dots .

We mainly discuss line elements in differential forms in Riemann geometry. By a geometrical view, these p -branes in M-theory can be seen as volume elements in spaces. Whence, we can construct a graph model for p -branes in a space and combinatorially research graphs in spaces.

Definition 4.1 For each m -brane \mathbf{B} of a space \mathbf{R}^m , let $(n_1(\mathbf{B}), n_2(\mathbf{B}), \dots, n_p(\mathbf{B}))$ be its unit vibrating normal vector along these p directions and $q : \mathbf{R}^m \rightarrow \mathbf{R}^4$ a continuous mapping. Now construct a graph phase $(\mathcal{G}, \omega, \Lambda)$ by

$$V(\mathcal{G}) = \{p\text{-branes } q(\mathbf{B})\},$$

$$E(\mathcal{G}) = \{(q(\mathbf{B}_1), q(\mathbf{B}_2)) | \text{there is an action between } \mathbf{B}_1 \text{ and } \mathbf{B}_2\},$$

$$\omega(q(\mathbf{B})) = (n_1(\mathbf{B}), n_2(\mathbf{B}), \dots, n_p(\mathbf{B})),$$

and

$$\Lambda(q(\mathbf{B}_1), q(\mathbf{B}_2)) = \text{forces between } \mathbf{B}_1 \text{ and } \mathbf{B}_2.$$

Then we get a graph phase $(\mathcal{G}, \omega, \Lambda)$ in \mathbf{R}^4 . Similarly, if $m = 11$, it is a graph phase for the M-theory.

As an example for applying M-theory to find an accelerating expansion cosmos of 4-dimensional cosmos from supergravity compactification on hyperbolic spaces is the *Townsend-Wohlfarth type metric* in which the line element is

$$ds^2 = e^{-m\phi(t)}(-S^6 dt^2 + S^2 dx_3^2) + r_C^2 e^{2\phi(t)} ds_{H_m}^2,$$

where

$$\phi(t) = \frac{1}{m-1}(\ln K(t) - 3\lambda_0 t), \quad S^2 = K^{\frac{m}{m-1}} e^{-\frac{m+2}{m-1}\lambda_0 t}$$

and

$$K(t) = \frac{\lambda_0 \zeta r_c}{(m-1) \sin[\lambda_0 \zeta |t + t_1|]}$$

with $\zeta = \sqrt{3 + 6/m}$. This solution is obtainable from space-like brane solution and if the proper time ζ is defined by $d\zeta = S^3(t)dt$, then the conditions for expansion and acceleration are $\frac{dS}{d\zeta} > 0$ and $\frac{d^2S}{d\zeta^2} > 0$. For example, the expansion factor is 3.04 if $m = 7$, i.e., a really expanding cosmos.

According to M-theory, the evolution picture of our cosmos started as a perfect 11 dimensional space. However, this 11 dimensional space was unstable. The original 11 dimensional space finally cracked into two pieces, a 4 and a 7 dimensional cosmos. The cosmos made the 7 of the 11 dimensions curled into a tiny ball, allowing the remaining 4 dimensional cosmos to inflate at enormous rates.

4.2. The combinatorial cosmos

The combinatorial speculation made the following combinatorial cosmos([17]).

Definition 4.2 *A combinatorial cosmos is constructed by a triple (Ω, Δ, T) , where*

$$\Omega = \bigcup_{i \geq 0} \Omega_i, \quad \Delta = \bigcup_{i \geq 0} O_i$$

and $T = \{t_i; i \geq 0\}$ are respectively called the cosmos, the operation or the time set with the following conditions hold.

- (1) (Ω, Δ) is a Smarandache multi-space dependent on T , i.e., the cosmos (Ω_i, O_i) is dependent on time parameter t_i for any integer $i, i \geq 0$.
- (2) For any integer $i, i \geq 0$, there is a sub-cosmos sequence

$$(S) : \Omega_i \supset \cdots \supset \Omega_{i1} \supset \Omega_{i0}$$

in the cosmos (Ω_i, O_i) and for two sub-cosmoses (Ω_{ij}, O_i) and (Ω_{il}, O_i) , if $\Omega_{ij} \supset \Omega_{il}$, then there is a homomorphism $\rho_{\Omega_{ij}, \Omega_{il}} : (\Omega_{ij}, O_i) \rightarrow (\Omega_{il}, O_i)$ such that

(i) for $\forall (\Omega_{i1}, O_i), (\Omega_{i2}, O_i), (\Omega_{i3}, O_i) \in (S)$, if $\Omega_{i1} \supset \Omega_{i2} \supset \Omega_{i3}$, then

$$\rho_{\Omega_{i1}, \Omega_{i3}} = \rho_{\Omega_{i1}, \Omega_{i2}} \circ \rho_{\Omega_{i2}, \Omega_{i3}},$$

where “ \circ ” denotes the composition operation on homomorphisms.

(ii) for $\forall g, h \in \Omega_i$, if for any integer i , $\rho_{\Omega, \Omega_i}(g) = \rho_{\Omega, \Omega_i}(h)$, then $g = h$.

(iii) for $\forall i$, if there is an $f_i \in \Omega_i$ with

$$\rho_{\Omega_i, \Omega_i \cap \Omega_j}(f_i) = \rho_{\Omega_j, \Omega_i \cap \Omega_j}(f_j)$$

for integers $i, j, \Omega_i \cap \Omega_j \neq \emptyset$, then there exists an $f \in \Omega$ such that $\rho_{\Omega, \Omega_i}(f) = f_i$ for any integer i .

By this definition, there is just one cosmos Ω and the sub-cosmos sequence is

$$\mathbf{R}^4 \supset \mathbf{R}^3 \supset \mathbf{R}^2 \supset \mathbf{R}^1 \supset \mathbf{R}^0 = \{P\} \supset \mathbf{R}_7^- \supset \cdots \supset \mathbf{R}_1^- \supset \mathbf{R}_0^- = \{Q\}.$$

in the string/M-theory. In Fig.4.1, we have shown the idea of the combinatorial cosmos.

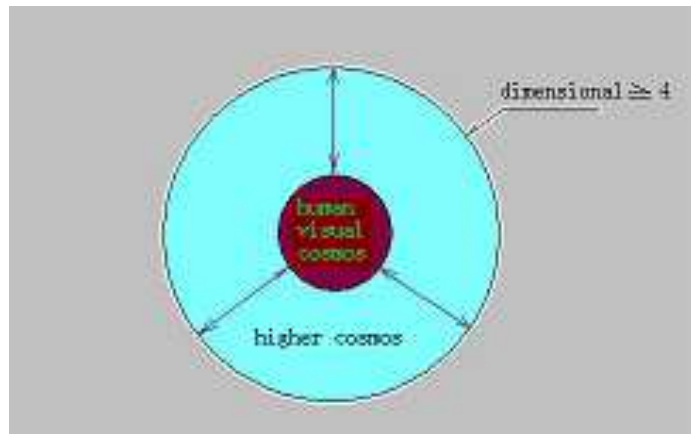

Fig.6. an example of combinatorial cosmoses

For 5 or 6 dimensional spaces, it has been established a dynamical theory by this combinatorial speculation([20][21]). In this dynamics, we look for a solution in

the Einstein equation of gravitational field in 6-dimensional spacetime with a metric of the form

$$ds^2 = -n^2(t, y, z)dt^2 + a^2(t, y, z)d\sum_k^2 + b^2(t, y, z)dy^2 + d^2(t, y, z)dz^2$$

where $d\sum_k^2$ represents the 3-dimensional spatial sections metric with $k = -1, 0, 1$ respective corresponding to the hyperbolic, flat and elliptic spaces. For 5-dimensional spacetime, deletes the undefinite z in this metric form. Now consider a 4-brane moving in a 6-dimensional *Schwarzschild-ADS spacetime*, the metric can be written as

$$ds^2 = -h(z)dt^2 + \frac{z^2}{l^2}d\sum_k^2 + h^{-1}(z)dz^2,$$

where

$$d\sum_k^2 = \frac{dr^2}{1 - kr^2} + r^2d\Omega_{(2)}^2 + (1 - kr^2)dy^2$$

and

$$h(z) = k + \frac{z^2}{l^2} - \frac{M}{z^3}.$$

Then the equation of a 4-dimensional cosmos moving in a 6-spacetime is

$$2\frac{\ddot{R}}{R} + 3\left(\frac{\dot{R}}{R}\right)^2 = -3\frac{\kappa_{(6)}^4}{64}\rho^2 - \frac{\kappa_{(6)}^4}{8}\rho p - 3\frac{\kappa}{R^2} - \frac{5}{l^2}$$

by applying the *Darmois-Israel conditions* for a moving brane. Similarly, for the case of $a(z) \neq b(z)$, the equations of motion of the brane are

$$\frac{d^2\dot{R} - d\ddot{R}}{\sqrt{1 + d^2\dot{R}^2}} - \frac{\sqrt{1 + d^2\dot{R}^2}}{n} \left(d\dot{n}\dot{R} + \frac{\partial_z n}{d} - (d\partial_z n - n\partial_z d)\dot{R}^2 \right) = -\frac{\kappa_{(6)}^4}{8}(3(p + \rho) + \hat{p}),$$

$$\frac{\partial_z a}{ad} \sqrt{1 + d^2\dot{R}^2} = -\frac{\kappa_{(6)}^4}{8}(\rho + p - \hat{p}),$$

$$\frac{\partial_z b}{bd} \sqrt{1 + d^2\dot{R}^2} = -\frac{\kappa_{(6)}^4}{8}(\rho - 3(p - \hat{p})),$$

where the energy-momentum tensor on the brane is

$$\hat{T}_{\mu\nu} = h_{\nu\alpha}T_{\mu}^{\alpha} - \frac{1}{4}Th_{\mu\nu}$$

with $T_{\mu}^{\alpha} = \text{diag}(-\rho, p, p, p, \hat{p})$ and the *Darmois-Israel conditions*

$$[K_{\mu\nu}] = -\kappa_{(6)}^2 \hat{T}_{\mu\nu},$$

where $K_{\mu\nu}$ is the extrinsic curvature tensor.

The combinatorial cosmos also presents new questions to combinatorics, such as:

- (i) to embed a graph into spaces with dimensional ≥ 4 ;
- (ii) to research the phase space of a graph embedded in a space;
- (iii) to establish graph dynamics in a space with dimensional $\geq 4, \dots$, etc..

For example, we have gotten the following result for graphs in spaces in [17].

Theorem 4.1 *A graph G has a nontrivial including multi-embedding on spheres $P_1 \supset P_2 \supset \dots \supset P_s$ if and only if there is a block decomposition $G = \biguplus_{i=1}^s G_i$ of G such that for any integer $i, 1 < i < s$,*

- (i) G_i is planar;
- (ii) for $\forall v \in V(G_i), N_G(x) \subseteq (\bigcup_{j=i-1}^{i+1} V(G_j))$.

Further research of the combinatorial cosmos will richen the knowledge of combinatorics and cosmology, also get the combinatorization for cosmology.

References

- [1] I.Antoniadis, Physics with large extra dimensions: String theory under experimental test, *Current Science*, Vol.81, No.12, 25(2001),1609-1613
- [2] S.S.Chern and W.H.Chern, *Lectures in Differential Geometry*(in Chinese), Peking University Press, 2001.
- [3] M.J.Duff, A layman's guide to M-theory, *arXiv*: hep-th/9805177, v3, 2 July(1998).
- [4] B.J.Fei, *Relativity Theory and Non-Euclid Geometries*, Science Publisher Press, Beijing, 2005.

- [5] U.Günther and A.Zhuk, Phenomenology of brane-world cosmological models, *arXiv: gr-qc/0410130*.
- [6] S.Hawking, *A Brief History of Times*, A Bantam Books/November, 1996.
- [7] S.Hawking, *The Universe in Nutshell*, A Bantam Books/November, 2001.
- [8] D.Ida, Brane-world cosmology, *arXiv: gr-qc/9912002*.
- [9] H.Iseri, *Smarandache Manifolds*, American Research Press, Rehoboth, NM,2002.
- [10] H.Iseri, *Partially Paradoxist Smarandache Geometries*, <http://www.gallup.unm.edu/~smarandache/Howard-Iseri-paper.htm>.
- [11] M.Kaku, *Hyperspace: A Scientific Odyssey through Parallel Universe, Time Warps and 10th Dimension*, Oxford Univ. Press.
- [12] P.Kanti, R.Madden and K.A.Olive, A 6-D brane world model, *arXiv: hep-th/0104177*.
- [13] L.Kuciuk and M.Antholy, An Introduction to Smarandache Geometries, *Mathematics Magazine, Aurora, Canada*, Vol.12(2003)
- [14] L.F.Mao, *On Automorphisms groups of Maps, Surfaces and Smarandache geometries*, *Sientia Magna*, Vol.1(2005), No.2, 55-73.
- [15] L.F.Mao, A new view of combinatorial maps by Smarandache's notion, *arXiv: math.GM/0506232*.
- [16] L.F.Mao, *Automorphism Groups of Maps, Surfaces and Smarandache Geometries*, American Research Press, 2005.
- [17] L.F.Mao, *Smarandache multi-space theory*, Hexis, Phoenix, AZ, 2006.
- [18] L.F.Mao, On algebraic multi-groups, *Sientia Magna*, Vol.2(2006), No.1, 64-70.
- [19] L.F.Mao, On multi-metric spaces, *Sientia Magna*, Vol.2(2006), No.1, 87-94.
- [20] E.Papantonopoulos, Braneworld cosmological models, *arXiv: gr-qc/0410032*.
- [21] E.Papantonopoulos, Cosmology in six dimensions, *arXiv: gr-qc/0601011*.
- [22] J.A.Peacock, *Cosmological Physics*, Cambridge University Press, 2003.
- [23] J.Polchinski, *String Theory*, Vol.1-Vol.2, Cambridge University Press, 2003.
- [24] D.Rabounski, Declaration of academic freedom: Scientific Human Rights, *Progress in Physics*, January (2006), Vol.1, 57-60.
- [25] F.Smarandache, Mixed noneuclidean geometries, *eprint arXiv: math/0010119*, 10/2000.
- [26] F.Smarandache, *A Unifying Field in Logics. Neutrosopy: Neturosophic Probability, Set, and Logic*, American research Press, Rehoboth, 1999.

- [27] F.Smarandache, Neutrosophy, a new Branch of Philosophy, *Multi-Valued Logic*, Vol.8, No.3(2002)(special issue on Neutrosophy and Neutrosophic Logic), 297-384.
- [28] F.Smarandache, A Unifying Field in Logic: Neutrosophic Field, *Multi-Valued Logic*, Vol.8, No.3(2002)(special issue on Neutrosophy and Neutrosophic Logic), 385-438.
- [29] J.Stillwell, *Classical topology and combinatorial group theory*, Springer-Verlag New York Inc., (1980).

21math-001-002



理论物理引发的二十一世纪数学

—Smarandache重空间理论*

毛林繁

(中国科学院数学与系统科学研究院, 北京 100080)

摘要. 从上个世纪二十年代开始, 理论物理学家一直致力于建立物理学的一种大统一理论, 即 *Theory of everything*. 这种祈求在几代物理学家的努力下, 于上个世纪末初见成效, 这就是理论物理中弦理论及 M- 理论的创立。物理学家同时意识到, 建立这种大统一理论的难点在于数学家没有建立与此相对应的数学理论, 用他们的话说, 就是二十一世纪的物理学已经建立起来了, 但制约其研究与发展的颈瓶在于数学家还没有建立起二十一世纪的数学理论。实际上, 物理学家可能不清楚, 在弦理论与 M- 理论建立的同时, 数学家也建立了一种可以称之为二十一世纪数学的理论, 这就是 Smarandache 重空间理论, 其应用的对象正是理论物理学家所祈求的, 当然, 作为一种数学理论, 其覆盖面远较理论物理的需求要广泛得多。本文的主要目的在于系统地介绍这一理论的产生背景、研究的主要问题、思想、主要方法以及主要研究成果等, 从中可以看出组合数学思想在其创立过程中起到的推动作用。本文主要取材于作者新近在美国出版的一本专著 [16] 中的部分材料。

The Mathematics of 21st Century Aroused by Theoretical Physics

Abstract. Begin with 20s in last century, physicists devote their works to establish a unified field theory for physics, i.e., the *Theory of Everything*. The

¹曾在全国第二届组合数学与图论学术交流会 (2006 年 8 月, 天津, 南开大学) 和四川省万源市中学报告 (2006 年 3 月)。

²e-print: 中国科技论文在线, 200607-91

aim is near in 1980s while the String/M-theory has been established. They also realize the bottleneck for developing the String/M-theory is there are no applicable mathematical theory for their research works. “*the Problem is that 21st-century mathematics has not been invented yet*”, They said. In fact, mathematician has established a new theory, i.e., the *Smarandache* multi-space theory applicable for their needing while the the String/M-theory was established. The purpose of this paper is to survey its historical background, main thoughts, research problems, approaches and some results based on the monograph [16] of mine. We can find the central role of combinatorial speculation in this process.

关键词: 宇宙大爆炸理论, M- 理论, 重空间, 地图几何, *Smarandache*几何, 伪度量空间几何, *Finsler*几何。

分类号 AMS(2000): 03C05, 05C15, 51D20,51H20, 51P05, 83C05,83E50

§1. 宇宙暴涨模型提出的数学问题

1.1. 物理时空

静态空间采用长、宽、高描写, 记: 长 = x , 宽 = y , 高 = z , 则一个静态空间可以用三个参数进行描写, 即坐标 (x, y, z) ; 动态空间采用长、宽、高、时间描写, 如果记时间变量为 t , 则一个动态空间可以采用坐标 (x, y, z, t) 描写。静态空间及其变化见图 1.1。将时间看作一个变化数轴, 则人类在某一个时刻看到的宇宙形态实际上是整个宇宙的一个截面 (section)。



图 1.1. 坐标系的时间变化

人类的生产生活实践表明, 人类生活的宇宙空间与上面动态空间是一致的, 即人类生活的空间是 3 维的, 如果加上时间变量, 则是 4 维的, 这就是 Einstein 的时空观。

1.2. 宇宙创生的大爆炸理论

依据人类数千年的观察，特别是 Einstein 的引力场方程，物理学家建立了宇宙的大爆炸理论，这种理论认为，宇宙起源于一个近似于真空状态的均匀球状空间，这个空间具有真空能。外界条件的变化，使这个均匀的、有能量的球空间发生了爆炸、合成基本粒子、释放能量，高温高能量状态下，基本粒子合成了最初几种简单物质，在经过近 137 亿年的演化形成了今天的浩瀚宇宙。

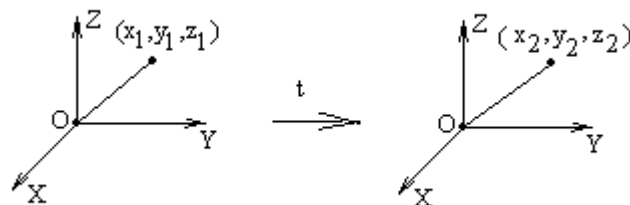
依据 Hawking 的观点，爆炸产生过程类似于水中气泡运动的结果 ([6] - [7])，如图 1.2 所示



图 1.2. 水中气泡的运动

图 1.3 中，详细描述了宇宙由大爆炸开始的演化与膨胀，直至产生今天人类观测得到的宇宙过程。

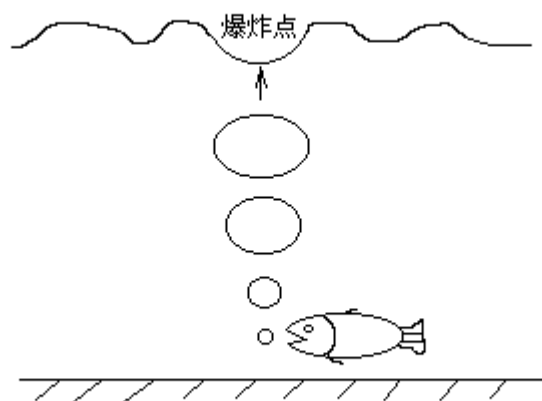

图 1.3. 宇宙大爆炸的过程

依据大爆炸理论的计算结果,宇宙诞生以后的演化过程大致如下:

起点 一宇宙大爆炸开始于一个真空球空间,一个约 137 亿年前爆炸的“原始火球”,它的起始时间为 0。它有无限高的温度和无限大的密度。目前还不能用已知的数学和物理的规律说明当时的情况。时间从此爆炸开始,空间也从此急剧膨胀扩大。

普朗克时代 一时间 10^{-43} 秒,密度是 $10^{93}kg/m^3$,温度降到 $10^{32}K$ 。这时的宇宙均匀而且对称,只有时间、空间和真空场。

大统一时代 一时间 10^{-35} 秒,温度降到 $10^{28}K$,宇宙发生了数次暴涨,其直径在 10^{-32} 秒的时间内增大了 10^{50} 倍。暴涨引起了数目惊人的粒子产生,这时虽然引力已从统一的力分离出来,但由于能量过高,强力、弱力和电磁力都还未分开,产生的粒子也没有区分。这一时期重子数不守恒的过程大量进行,造成重子略多于反重子,其后温度降低,等数目的重子和反重子相遇湮灭,就留下了只有中子和质子而几乎看不到反重子的不对称的现时的宇宙。

强子时代 一时间 10^{-6} 秒,温度为 $10^{14}K$;

轻子时代 一时间 10^{-2} 秒,温度为 $10^{12}K$;这期间,强作用、弱作用和电磁作用逐渐区分开。宇宙中出现了各种粒子,由于温度很高 ($10^{10}K$ 以上),粒子的生存时间都是极短的,它们通过相互碰撞而相互转化,原子这时还没出现。

辐射时代 一时间 1 – 10 秒,温度降至约 $10^{10} - 5 \times 10^9K$,质子和反质子、电子和正电子相遇时湮灭,产生了大量的光子、中微子以及反中微子,基本粒子开始结合成原子核,能量以光子辐射的形式出现(人们探索微观世界和宇宙结构的努力在这里会合)。

氦形成时代 一时间 3 分钟,温度降至约 10^9K ,直径膨胀到约 1 光年大小,有近三成物质合成为氦,核反应消失;半小时后,有质量的粒子数和光子数的比约达到了 10^{-9} ,辐射密度仍然大于物质密度。

粒子数丰度稳定时代 半小时后,温度降低到 10^8K ,各种粒子在相互碰撞中因能量不足已不能相互转化(少量的湮灭除外),从这时起,宇宙中各种粒子数的丰度就趋于稳定。由于这时温度仍然很高,光子有足够的能量击碎任何短暂形成的原子,把后者的电子剥去,所以当时没有可能出现原子。

进入物质时代 一时间 1000 – 2000 年,温度降至约 10^5K ,物质密度开始大于辐射密度。由于宇宙的膨胀,光子到达任何一点(例如一个刚刚形成的原子)时都将因退行引起的多普勒效应而使其波长增大而能量减小,由于退行速度随宇宙的膨胀而逐渐增大,这些光子的波长也就不断增大而能量不断减小。

物质从背景辐射中透明出来 一时间 10^5 年,温度降至约 $5000K$,物质温度开始

低于辐射温度,最重和最轻的基本粒子数的比值保持恒定。大约经过一百万年,由爆炸初期产生的光子的能量就降到了不足以击碎原子甚至激发原子的程度,宇宙这时就进入了光子和原子相互分离的退耦时代,即宇宙变成了透明的,温度大约降为 3000K。从这时开始,原子开始形成,但也只能产生较轻的元素。至于较重的元素,那是在星系、恒星形成后,在恒星内部形成的,恒星形成后,各恒星内部产生了各自不同的温度。超过铁的更重元素则是在超新星爆发或星系的碰撞、爆发中形成的。

星系形成—时间 10^8 年,辐射温度降至约 100K,物质温度为 1K。

类星体、恒星、行星及生命先后出现——时间 10^9 年,温度降至约 12K,太空逐渐形成我们后来观测到的情景。

目前阶段—时间 10^{10} 年,辐射温度降至约 3K,星系物质温度约 10^5 K。

1.3. 宇宙大爆炸理论引出的数学问题

理论物理与实验物理研究表明物质由三种物质粒子,即电子 e、上夸克 u 和下夸克 d 构成。二十世纪初出现了两种描述粒子之间相互作用的理论,这就是 Einstein 的相对论和 Dirac 的量子力学。相对论是描述引力的理论,一般用于研究宇宙物理学;而量子力学是关于微观粒子作用力的理论,包括电磁力、强核磁力、弱核磁力。这四种作用力构成了粒子之间相互作用的基本作用力。

从上个世纪二十年代开始,许多物理学家,包括 Einstein 本人一直致力于统一这四种基本作用力,即统一相对论和量子力学,建立物理学的大统一理论,即文献中经常出现的 *Theory of Everything*。经过 80 多年的研究,问题一直没有得到圆满解决。问题的难点在于广义相对论是关于宏观宇宙的理论,如银河系、太阳系、黑洞等,其假设物质是连续分布的;而量子力学是关于微观宇宙的理论,如电子、质子、中子等,其假设物质是离散分布的。而且伴随着深入研究,带来了人类认识领域的一些新问题,比如

宇宙是唯一的吗?如果不唯一,有多少个宇宙?为什么人类看不到其他宇宙?
人类生活其中的宇宙的维数等于多少?真的如人类通常认为的 3 维吗?

Einstein 依据其提出的广义相对性原理:所有物理规律在任意参考系中具有相同的形式和等效原理:在一个较小的区域内惯性力和引力的任何物理效应是不可区分的建立了引力场方程,即

$$R_{\mu\nu} - \frac{1}{2}Rg_{\mu\nu} + \lambda g_{\mu\nu} = -8\pi GT_{\mu\nu}.$$

结合宇宙学原理,即度量尺度为 $10^{41}l.y$ 时,宇宙中任何一点和一个点的任何方向均

无差别, *Robertson-Walker*得到了引力场方程的一种球对称解

$$ds^2 = -c^2 dt^2 + a^2(t) \left[\frac{dr^2}{1 - Kr^2} + r^2(d\theta^2 + \sin^2 \theta d\varphi^2) \right].$$

相应的宇宙称为 Friedmann 宇宙。经过多年的天文观察, Hubble 在 1929 发现, 人类居住的宇宙是一个日益加速膨胀的宇宙, 故探求引力场方程的加速膨胀解成了物理学家的主要方向, 即其需满足条件

$$\frac{da}{dt} > 0, \quad \frac{d^2a}{dt^2} > 0.$$

我们知道, 若

$$a(t) = t^\mu, \quad b(t) = tv,$$

这里,

$$\mu = \frac{3 \pm \sqrt{3m(m+2)}}{3(m+3)}, \quad \nu = \frac{3 \mp \sqrt{3m(m+2)}}{3(m+3)},$$

则 Kasner 度规

$$ds^2 = -dt^2 + a(t)^2 d_{\mathbf{R}^3}^2 + b(t)^2 ds^2(T^m)$$

为 Einstein 场方程的 $4+m$ 维真空解。一般情况下, 这个解并不能给出 4 维加速膨胀解。但采用时间转移对称变换

$$t \rightarrow t_{+\infty} - t, \quad a(t) = (t_{+\infty} - t)^\mu,$$

我们得到一个 4 维的加速膨胀解, 因为

$$\frac{da(t)}{dt} > 0, \quad \frac{d^2a(t)}{dt^2} > 0.$$

二十世纪末出现的 M- 理论为解决上述问题奠定了基础。这一理论假设粒子不是质点而是维数不同的 p -膜, 即沿着 p 个方向有长度的子空间, 这里 p 是一个正整数。1-膜一般称作弦, 2-膜称作面膜。图 1.4 中给出了 1-膜、2-膜及其运动。



图 1.4. 膜的运动

依据 M 理论, 宇宙创生开始时的那个球形空间维数是 11 维的, 大爆炸开始后, 其中 4 个方向维在急剧的扩张、延伸, 而另外 7 个方向维则在急剧卷曲、缩小, 这样形成我们今天看得到的 4 维宏观宇宙和看不见的 7 维微观宇宙。4 维宏观宇宙内的作用力符合 Einstein 引力场方程, 而 7 维微观宇宙内的作用力符合迪拉克方程, 由此得到下面这个结论。

定理 1.1 M- 理论的时空是一个在每个点卷曲一个 7 维空间 \mathbf{R}^7 的 4 维空间 \mathbf{R}^4 。

应用定理 1.1 和双曲空间上的超引力的紧化条件, 我们可以得到 *Townsend-Wohlfarth* 型的 4 维加速膨胀宇宙模型

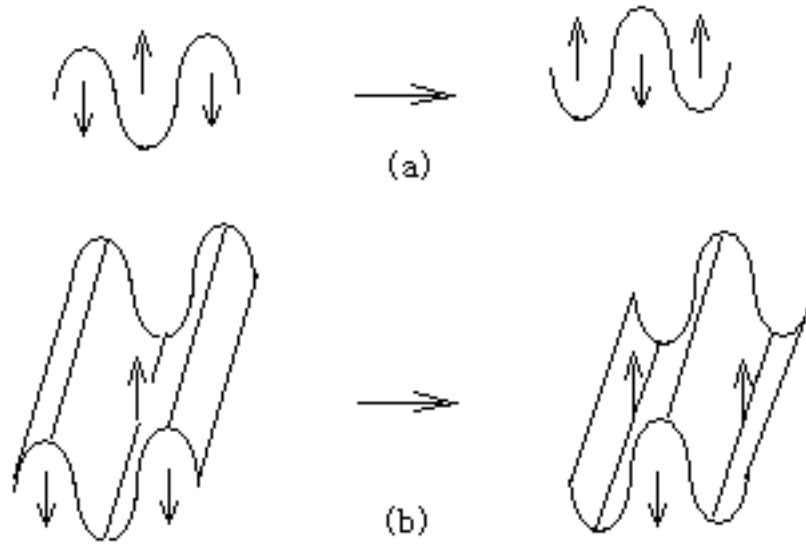
$$ds^2 = e^{-m\phi(t)}(-S^6 dt^2 + S^2 dx_3^2) + r_C^2 e^{2\phi(t)} ds_{H_m}^2,$$

这里

$$\phi(t) = \frac{1}{m-1}(\ln K(t) - 3\lambda_0 t), \quad S^2 = K^{\frac{m}{m-1}} e^{-\frac{m+2}{m-1}\lambda_0 t}$$

且

$$K(t) = \frac{\lambda_0 \zeta r_c}{(m-1) \sin[\lambda_0 \zeta |t + t_1|]},$$

这里 $\zeta = \sqrt{3 + 6/m}$. 取时间 ς 满足 $d\varsigma = S^3(t)dt$, 则加速膨胀宇宙的条件 $\frac{dS}{d\varsigma} > 0$ 和 $\frac{d^2 S}{d\varsigma^2} > 0$ 均得到满足。数值计算表明, 若 $m = 7$ 则膨胀因子为 3.04。

从数学角度讲, 定理 1.1 中的点实际上不是点而是空间, 由此引深的数学问题是

是否存在这样一种数学空间, 其中每个点包含另一个 1 维以上的空间?

直觉表明, 如果这样的数学空间存在, 那它一定不是我们日常生活中看得到的空间, 也不是我们在经典数学中遇见过的空间, 例如在 3 维线性空间中, 每个点可以表示为 (x, y, z) , 它不可能包含一个维数大于等于 1 的子空间。

§2. Smarandache 重空间

首先考虑一个简单的问题:

$$1 + 1 = ?$$

在自然数系中, 我们知道 $1+1=2$ 。在 2 进制运算体系中, 我们还知道 $1+1=10$, 这里的 10 实际上还是 2。因为在 2 进制运算体系中只有两个运算元素 0 和 1, 其运算规则为

$$0 + 0 = 0, 0 + 1 = 1, 1 + 0 = 1, 1 + 1 = 10.$$

依据“否定之否定等于肯定”的哲学思想, 我们采用一种“反思维的、叛逆的”思想 ([18] - [20]) 来重新看待这个问题, 重新分析 $1 + 1 = 2$ 或 $\neq 2$ 。

我们知道 $1, 2, 3, 4, 5, \dots$ 这样的数构成自然数系 N 。在这个数系中, 依据数数的规律, 每个数称为前面紧邻着的数的后继数, 即 2 的后继数为 3, 记为 $2' = 3$ 。同样, $3' = 4, 4' = 5, \dots$ 。这样我们就得到了

$$1 + 1 = 2, 2 + 1 = 3, 3 + 1 = 4, 4 + 1 = 5, \dots;$$

同时还得到了

$$1 + 2 = 3, 1 + 3 = 4, 1 + 4 = 5, 1 + 5 = 6, \dots$$

这样一些运算等式。从而在这种自然数的运算体系下, 我们只能得到 $1 + 1 = 2$ 的结论。

现在, 我们回顾一下运算的定义。给定一个集合 S , 对 $\forall x, y \in S$, 定义 $x * y = z$, 意思是 S 上存在一个 2 元结合映射 $*: S \times S \rightarrow S$, 使得

$$*(x, y) = z.$$

采用图解的方式, 我们可以用图把这种关系在平面上表示出来。首先把 S 中的每个元用平面上的点表示, 如果 S 中有 n 个元, 则在平面上就取 n 个不共线的点; 两个点 x, z 之间连接一条有向线段, 如果存在一个元 y 使得 $x * y = z$, 我们在这条线段上标上 $*y$, 称为该线段的权重, 如图 2.1 所示。



图 2.1. 连线及赋权方法

注意这种对应是 $1-1$ 的。记 S 对应的图为 $G[S]$ 。现在, 如果我们想找到一个满足 $1 + 1 = 3$ 的运算系统, 我们可以先给出 $1 + 1, 2 + 1, \dots$ 等初值并通过图解来完成。

定义 2.1 一个代数系统 $(A; \circ)$ 称为单一的若存在一个映射 $\varpi : A \rightarrow A$ 使得对 $\forall a, b \in A$, 只要 $a \circ b \in A$, 则存在一个唯一的元 $c \in A, c \circ \varpi(b) \in A$, 相应地称 ϖ 为单一映射。

我们很容易得到以下关于代数系统 $(A; \circ)$ 与图 $G[A]$ 的关系的一个结果。

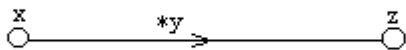
定理 2.1 设 $(A; \circ)$ 为一个代数系统, 则

(i) 若 $(A; \circ)$ 上存在一个单一映射 ϖ , 则 $G[A]$ 是一个 Euler 图。反之, 若 $G[A]$ 是一个 Euler 图, 则 $(A; \circ)$ 是一个单一运算系统。

(ii) 若 $(A; \circ)$ 是一个完全的代数运算系统, 则 $G[A]$ 中每个顶点的出度为 $|A|$; 此外, 如果 $(A; \circ)$ 上消去律成立, 则 $G[A]$ 是一个完全的重 2- 图且每个顶点粘合一个环使得不同顶点之间的边为相对 2- 边, 反之亦然。

对于有限个元的情形, 可以采用一种有限图的方式规定出所有运算结果, 图 2.2 给出了 $|S| = 3$ 的两种运算体系。



图 2.2. 3 个元的加法运算图

由图 2.2(a) 有

$$1+1 = 2, 1+2 = 3, 1+3 = 1; 2+1 = 3, 2+2 = 1, 2+3 = 2; 3+1 = 1, 3+2 = 2, 3+3 = 3.$$

由图 2.2(b) 有

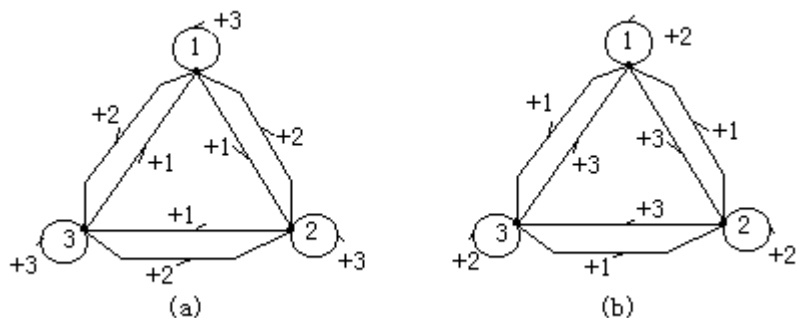
$$1+1 = 3, 1+2 = 1, 1+3 = 2; 2+1 = 1, 2+2 = 2, 2+3 = 3; 3+1 = 2, 3+2 = 3, 3+3 = 1.$$

对一个集合 $S, |S| = n$, 可以在其上定义 n^3 种不同的运算体系。这样我们就可以在一个集合上同时定义出 h 种运算, $h \leq n^3$ 而得到一个 h -重运算体系 $(S; \circ_1, \circ_2, \dots, \circ_h)$ 。在经典代数学中, 群是单一的运算体系, 环、域、体等均是 2 重运算体系。一般地, 我们定义一个 Smarandache n -重空间如下。

定义 2.2 一个 n -重空间 Σ , 定义为 n 个集合 A_1, A_2, \dots, A_n 的并

$$\Sigma = \bigcup_{i=1}^n A_i$$

且每个集合 A_i 上均定义了一种运算 \circ_i 使得 (A_i, \circ_i) 为一个代数体系, 这里 n 为正整数, $1 \leq i \leq n$ 。

在重空间的框架下, 我们可以进一步推广经典代数学中群、环、域及向量空间的概念而得到重群、重环、重域及重向量空间的概念, 并得到相应的代数结构。

定义 2.3 设 $\tilde{R} = \bigcup_{i=1}^m R_i$ 为一个完备的 m -重空间, 且对任意整数 $i, j, i \neq j, 1 \leq i, j \leq m, (R_i; +_i, \times_i)$ 为一个环且对任意元 $\forall x, y, z \in \tilde{R}$, 只要相应的运算结果均存在, 则有

$$(x +_i y) +_j z = x +_i (y +_j z), \quad (x \times_i y) \times_j z = x \times_i (y \times_j z)$$

以及

$$x \times_i (y +_j z) = x \times_i y +_j x \times_i z, \quad (y +_j z) \times_i x = y \times_i x +_j z \times_i x,$$

则称 \tilde{R} 为一个 m -重环。若对任意整数 $i, 1 \leq i \leq m$, $(R; +_i, \times_i)$ 是一个域, 则称 \tilde{R} 为一个 m -重域。

定义 2.4 设 $\tilde{V} = \bigcup_{i=1}^k V_i$ 为一个完备的 m -重空间, 其运算集合为 $O(\tilde{V}) = \{(\dot{+}_i, \cdot_i) \mid 1 \leq i \leq m\}$, $\tilde{F} = \bigcup_{i=1}^k F_i$ 为一个重域, 其运算集合为 $O(\tilde{F}) = \{(+_i, \times_i) \mid 1 \leq i \leq k\}$ 。若对任意整数 $i, j, 1 \leq i, j \leq k$ 及任意元 $\forall \mathbf{a}, \mathbf{b}, \mathbf{c} \in \tilde{V}, k_1, k_2 \in \tilde{F}$, 只要对应的运算结果存在, 则

(i) $(V_i; \dot{+}_i, \cdot_i)$ 为域 F_i 上的向量空间, 其向量加法为 “ $\dot{+}_i$ ”, 标量乘法为 “ \cdot_i ”;

(ii) $(\mathbf{a} \dot{+}_i \mathbf{b}) \dot{+}_j \mathbf{c} = \mathbf{a} \dot{+}_i (\mathbf{b} \dot{+}_j \mathbf{c})$;

(iii) $(k_1 +_i k_2) \cdot_j \mathbf{a} = k_1 +_i (k_2 \cdot_j \mathbf{a})$;

则称 \tilde{V} 为重域 \tilde{F} 上的 k 重向量空间, 记为 $(\tilde{V}; \tilde{F})$ 。

由此我们知道, M -理论中的空间模型实际上是一种重空间模型。

定理 2.2 设 $P = (x_1, x_2, \dots, x_n)$ 为 n -维欧氏空间 \mathbf{R}^n 中的一个点。则对任意整数 $s, 1 \leq s \leq n$, 点 P 包含一个 s 的子空间。

证明 注意欧氏空间 \mathbf{R}^n 中存在标准基 $e_1 = (1, 0, 0, \dots, 0), e_2 = (0, 1, 0, \dots, 0), \dots, e_i = (0, \dots, 0, 1, 0, \dots, 0)$ (第 i 个元为 1, 其余为 0), $\dots, e_n = (0, 0, \dots, 0, 1)$ 使得 \mathbf{R}^n 中的任意点 (x_1, x_2, \dots, x_n) 可以表示为

$$(x_1, x_2, \dots, x_n) = x_1 e_1 + x_2 e_2 + \dots + x_n e_n$$

取域 $F = \{a_i, b_i, c_i, \dots, d_i; i \geq 1\}$, 我们定义一个新的向量空间

$$\mathbf{R}^- = (V, +_{new}, \circ_{new}),$$

这里 $V = \{x_1, x_2, \dots, x_n\}$ 。不失普遍性, 我们假定 x_1, x_2, \dots, x_s 是独立的, 即若存在标量 a_1, a_2, \dots, a_s 使得

$$a_1 \circ_{new} x_1 +_{new} a_2 \circ_{new} x_2 +_{new} \cdots +_{new} a_s \circ_{new} x_s = 0,$$

则定有 $a_1 = a_2 = \cdots = 0_{new}$ 且存在标量 $b_i, c_i, \cdots, d_i, 1 \leq i \leq s$, 使得

$$x_{s+1} = b_1 \circ_{new} x_1 +_{new} b_2 \circ_{new} x_2 +_{new} \cdots +_{new} b_s \circ_{new} x_s;$$

$$x_{s+2} = c_1 \circ_{new} x_1 +_{new} c_2 \circ_{new} x_2 +_{new} \cdots +_{new} c_s \circ_{new} x_s;$$

.....;

$$x_n = d_1 \circ_{new} x_1 +_{new} d_2 \circ_{new} x_2 +_{new} \cdots +_{new} d_s \circ_{new} x_s.$$

从而我们得到点 P 上的一个 s - 维子空间。 \square

推论 2.1 设 P 为欧氏空间 \mathbf{R}^n 中的一个点。则存在一个子空间序列

$$\mathbf{R}_0^- \subset \mathbf{R}_1^- \subset \cdots \subset \mathbf{R}_{n-1}^- \subset \mathbf{R}_n^-$$

使得 $\mathbf{R}_n^- = \{P\}$ 且子空间 \mathbf{R}_i^- 的维数为 $n - i$, 这里 $1 \leq i \leq n$ 。

§3. 地图与地图几何

3.1. Smarandache 几何

*Smarandache*几何 是一种最广泛的非欧几何, 其内容涵盖目前熟知的 Lobachevshy-Bolyai 几何、Riemann 几何与 Finsler 几何, 其出发点是采用反命题逐条取代欧氏几何中的对应公设。我们首先回顾一下欧氏几何及双曲几何、Riemann 几何的创立过程。

欧氏几何的公理体系由下面这五条公设组成:

- (1)从每个点到每个其他的点必定可以引直线;
- (2)每条直线都可以无限延长;
- (3)以任意点为中心, 通过任何给定的另一点可以作一圆;
- (4)所有直角都相等;

(5)同平面内如有一条直线与另两条直线相交,且在前一条直线的一侧所交的两内角之和小于两直角,则后两条直线必在这一侧相交,如图 3.1 所示。



图 3.1. 一条直线与两条不平行直线相交

这里, $\angle a + \angle b < 180^\circ$ 。最后一条公设通称为欧氏第五公设,它还可以采用下面这种叙述方法:

过给定直线外的一点,恰存在一条直线与给定的直线不相交。

自从欧氏公设公布以来,人们一直觉得其第五公设不应该作为公设出现,它看上去实在应该是一个命题。为此,许多数学家致力于采用前四条公设证明第五公设,但一直没有成功。于是有人想用其他假设代替欧氏第五公设,检验得到的公理体系是否完备,是否存在矛盾。十九世纪, Lobachevshy 和 Bolyai、Riemann 分别采用不同的假设取代欧氏第五公设获得成功。他们采用的假设分别是:

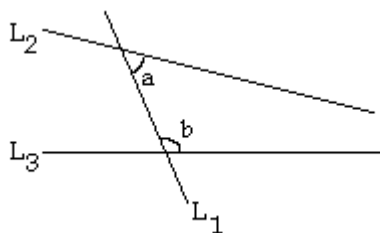
Lobachevshy-Bolyai 假设: 过给定直线外的一点,至少存在两条直线与给定的直线不相交。

Riemann 假设: 过给定直线外的一点,不存在直线与给定的直线不相交。

Riemann 假设得到重视的原因在于由此可以建立黎曼几何,后者被 Einstein 用为其相对论中的引力时空,即把引力场看作一个黎曼空间。

同样地,我们是否可以进一步去改变欧氏公设得到新的几何而涵盖原有的欧氏几何、Lobachevshy-Bolyai 几何、Riemann 几何和 Finsler 几何? 文献 [16] 中解决了这个问题。问题的解决得力于应用 Smarandache 几何思想而建立伪度量空间几何,这里对 Smarandache 几何作一个简要介绍如下,下一节再介绍伪度量空间几何。

Smarandache 几何包含悖论几何、非几何、反射影几何和反几何等四种,分别依据不同的公设建立。其中,悖论几何采用的公设为欧氏公设 (1) - (4) 以及下面任何一条公设:

(P - 1) 至少存在一条直线和该直线外的一点,使得经过该点的直线均与这条

直线不相交；

($P-2$) 至少存在一条直线和该直线外的一点，使得经过该点恰存在一条直线与这条直线不相交；

($P-3$) 至少存在一条直线和该直线外的一点，使得经过该点恰存在有限的 k 条直线与这条直线不相交， $k \geq 2$ ；

($P-4$) 至少存在一条直线和该直线外的一点，使得经过该点恰存无数条直线与这条直线不相交；

($P-5$) 至少存在一条直线和该直线外的一点，使得经过该点的任何直线均与这条直线相交。

非几何采用的公理体系是否定欧氏几何 5 条公设中的 1 个或数个，即采用以下一条或数条公设取代欧氏公设中的对应公设：

- (-1) 过给定的任意两点不一定存在一条直线；
- (-2) 存在一条直线不能无限延长；
- (-3) 给定一点和一个实数，并不一定可以画出一个圆；
- (-4) 直角并不一定相等；
- (-5) 过给定直线外的一点，不一定存在一条直线与给定的直线不相交。

反射影几何采用的公理体系是否定射影几何中的一条或数条公设，相应采用下述公设取代：

- ($C-1$) 至少存在两条直线或没有直线包含两个给定的点；
- ($C-2$) 设 A, B, C 为三个不共线的点， D, E 为两个不同点。若 A, D, C 和 B, E, C 三点共线，则通过 A, B 的直线与通过 D, E 的直线不相交；
- ($C-3$) 每条直线至多含有两个不同的点。

反几何采用的公理体系是否定 Hilbert 公理体系中的一条或数条公设。

定义 3.1 一个公设称为 *Smarandache* 否定的，若其在同一个空间中同时表现出成立或不成立，或至少以两种以上方式表现不成立。

一个含有 *Smarandache* 否定公设的几何称为 *Smarandache* 几何。

下面这个例子以及下面两小节表明 *Smarandache* 几何是普遍存在的。

例 3.1 设 A, B, C 为欧氏平面上三个不共线的点，定义直线为欧氏平面上通过 A, B, C 中恰好一个点的直线。则我们得到一个 *Smarandache* 几何。因为与欧氏几何公理体系相比较，其中两条公设是 *Smarandache* 否定的。

(i) 欧氏第五公设现在为经过一条直线外的一点, 存在一条或不存在直线平行于该条直线所取代。假设直线 L 经过点 C 且平行于直线 AB 。注意经过任何一个不在 AB 上的点恰好有一条直线平行于 L , 而经过直线 AB 上的任何一点均不存在平行于 L 的直线, 如图 3.2(a) 所示。

(ii) 公设经过任意两个不同点存在一条直线现在为经过任意两个不同点存在一条直线或不存在直线取代。注意经过两个点 D, E , 这里 D, E 与 A, B, C 中的一点, 如点 C 共线, 如图 3.2(b) 所示, 恰好有一条直线经过 D, E 。而对任意两个在直线 AB 点 F, G 或不与 A, B, C 中一个点共线的两个点 G, H 均不存在经过它们的直线, 如图 3.2(b) 所示。



图 3.2. s- 直线的情况

3.2 什么是地图?

拓扑学中一个很著名的定理说每个曲面或者为球面, 或者同胚于在球面上挖去 $2p$ 个洞, 每两个洞之间采用一个柱面 (管子) 相连; 或者同胚于在球面上挖去 q 个洞, 每个洞采用麦比乌斯带的边界与其相粘合。前者为可定向曲面, 亏格定义为 p ; 后者为不可定向曲面, 亏格定义为 q 。这里可定向的意思是一个垂直于曲面的向量沿着曲面运动一圈后回到出发点是否改变向量的方向。直观上知道球面是可定向的, 而麦比乌斯带则是不可定向的, 如图 3.3 所示, 其中 (a) 为剪开的纸面, (b) 为粘合后的麦比乌斯带。

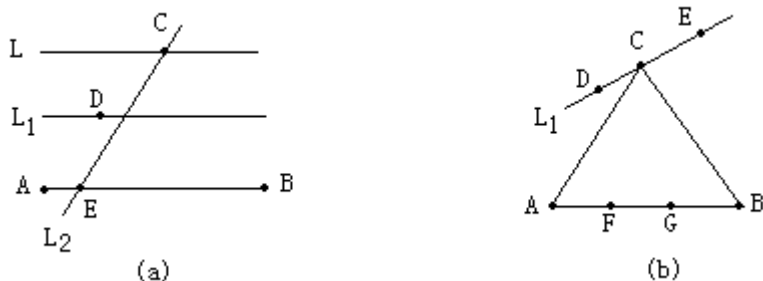

图 3.3. 麦比乌斯带的形成

地图是曲面的一种划分, 当沿着这种划分将曲面剪开后, 得到的每个面块均同胚于圆盘 $D = \{(x, y) | x^2 + y^2 \leq 1\}$. Tutte 于 1973 年给出了地图的代数定义, 采用 [12] 中的术语, 地图定义于下.

定义 3.2 一个地图 $M = (\mathcal{X}_{\alpha, \beta}, \mathcal{P})$, 定义为在基础集合 X 的四元胞腔 $Kx, x \in X$ 的无公共元的并集 $\mathcal{X}_{\alpha, \beta}$ 上的一个基本置换 \mathcal{P} , 且满足下面的公理 1 和公理 2, 这里 $K = \{1, \alpha, \beta, \alpha\beta\}$ 为 Klein 4-元群, 所谓 \mathcal{P} 为基本置换, 即不存在正整数 k , 使得 $\mathcal{P}^k x = \alpha x$.

公理 1: $\alpha\mathcal{P} = \mathcal{P}^{-1}\alpha$;

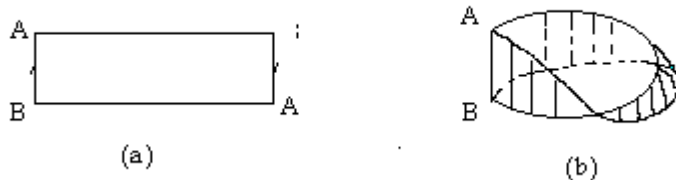
公理 2: 群 $\Psi_I = \langle \alpha, \beta, \mathcal{P} \rangle$ 在 $\mathcal{X}_{\alpha, \beta}$ 上可迁.

依据定义 3.2, 地图的顶点和面分别定义为置换 \mathcal{P} 和 $\mathcal{P}\alpha\beta$ 作用于 $\mathcal{X}_{\alpha, \beta}$ 上得到的共轭轨道; 边为 Klein 4-元群 K 作用于 $\mathcal{X}_{\alpha, \beta}$ 上得到的轨道. 利用 Euler-Poincaré 公式, 我们得到

$$|V(M)| - |E(M)| + |F(M)| = \chi(M),$$

这里 $V(M), E(M), F(M)$ 分别表示地图 M 的顶点集、边集和面集, $\chi(M)$ 表示地图 M 的 Euler 亏格, 其数值等于地图 M 所嵌入的那个曲面的 Euler 亏格. 称一个地图 $M = (\mathcal{X}_{\alpha, \beta}, \mathcal{P})$ 是不可定向的, 若置换群 $\Psi_I = \langle \alpha, \beta, \mathcal{P} \rangle$ 在 $\mathcal{X}_{\alpha, \beta}$ 上是可迁的, 否则称为可定向的.



图 3.4. 图 $D_{0.4.0}$ 在 Klein 曲面上的嵌入

作为一个例子, 图 3.4 中给出了图 $D_{0.4.0}$ 在 Klein 曲面上的一个嵌入, 可以采用地图 $M = (\mathcal{X}_{\alpha, \beta}, \mathcal{P})$ 表示如下, 这里

$$\mathcal{X}_{\alpha, \beta} = \bigcup_{e \in \{x, y, z, w\}} \{e, \alpha e, \beta e, \alpha\beta e\},$$

$$\mathcal{P} = (x, y, z, w)(\alpha\beta x, \alpha\beta y, \beta z, \beta w)$$

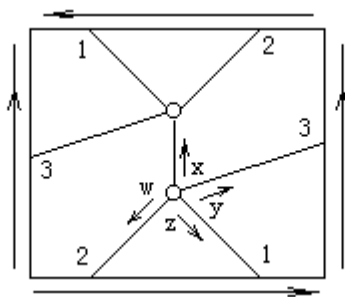
$$\times (\alpha x, \alpha w, \alpha z, \alpha y)(\beta x, \alpha\beta w, \alpha\beta z, \beta y).$$

图 3.4 中的地图有 2 顶点 $v_1 = \{(x, y, z, w), (\alpha x, \alpha w, \alpha z, \alpha y)\}$, $v_2 = \{(\alpha\beta x, \alpha\beta y, \beta z, \beta w), (\beta x, \alpha\beta w, \alpha\beta z, \beta y)\}$, 4 条边 $e_1 = \{x, \alpha x, \beta x, \alpha\beta x\}$, $e_2 = \{y, \alpha y, \beta y, \alpha\beta y\}$, $e_3 = \{z, \alpha z, \beta z, \alpha\beta z\}$, $e_4 = \{w, \alpha w, \beta w, \alpha\beta w\}$ 以及 2 个面 $f_2 = \{(x, \alpha\beta y, z, \beta y, \alpha x, \alpha\beta w), (\beta x, \alpha w, \alpha\beta x, y, \beta z, \alpha y)\}$, $f_2 = \{(\beta w, \alpha z), (w, \alpha\beta z)\}$, 其 Euler 亏格为

$$\chi(M) = 2 - 4 + 2 = 0$$

且置换群 $\Psi_I = \langle \alpha\beta, \mathcal{P} \rangle$ 在 $\mathcal{X}_{\alpha, \beta}$ 上可迁。这样就从代数角度得到图 $D_{0.4.0}$ 在 Klein 面上的嵌入。

伴随着理论物理研究的需要, 我们还可以一般性地考虑图在空间以及多重曲面上的嵌入。图在重曲面上的嵌入定义如下。

定义 3.3 设图 G 的顶点集合具有划分 $V(G) = \bigcup_{j=1}^k V_j$, 这里对任意整数 $1 \leq i, j \leq k$, $V_i \cap V_j = \emptyset$, 又 S_1, S_2, \dots, S_k 为度量空间 \mathcal{E} 中的 k 个曲面, $k \geq 1$ 。若存在一个 1-1 连续映射 $\pi: G \rightarrow \mathcal{E}$ 使得对任意整数 $i, 1 \leq i \leq k$, $\pi|_{\langle V_i \rangle}$ 是一个浸入且 $S_i \setminus \pi(\langle V_i \rangle)$ 中的每个连通片同胚于圆盘 $D = \{(x, y) | x^2 + y^2 \leq 1\}$, 则称 $\pi(G)$ 是 G 在曲面 S_1, S_2, \dots, S_k 上的重嵌入。

定义 3.3 中曲面 S_1, S_2, \dots, S_k 的空间位置对重嵌入有影响。当存在一种排列 $S_{i_1}, S_{i_2}, \dots, S_{i_k}$, 使得对任意整数 $j, 1 \leq j \leq k$, S_{i_j} 是 $S_{i_{j+1}}$ 的子空间时, 称为 G 在 S_1, S_2, \dots, S_k 上的内含重嵌入。关于球面, 有下面的结论。

定理 3.1 一个图 G 在球面 $P_1 \supset P_2 \supset \dots \supset P_s$ 存在非平凡的内含重嵌入当且仅当图 G 存在块划分 $G = \biguplus_{i=1}^s G_i$, 使得对任意整数 $i, 1 < i < s$,

(i) G_i 是平面的;

(ii) 对任意 $\forall v \in V(G_i)$, $N_G(x) \subseteq (\bigcup_{j=i-1}^{i+1} V(G_j))$.

3.3 地图几何

地图几何是在地图基础上构建的 Smarandache 几何, 同时也是联系组合数学与经典数学的纽带。地图几何的概念首先在文献 [13] 中提出, 随后在文献 [14] – [16] 中, 特别是 [16] 进行了细致的研究, 其定义如下。

定义 3.4 在地图 M 每个顶点 $u, u \in V(M)$ 上赋予一个实数 $\mu(u), \mu(u) \rho_M(u) \pmod{2\pi}$,

称 (M, μ) 为一个地图几何, $\mu(u)$ 为点 u 的角因子函数。视允许或不允许曲线上的曲线穿过某一个或某几个面而称该地图几何无边界或有边界。

图 3.5 中给出了直线穿过地图上的顶点的情形这里的弯折角度分为大于 π 、等于 π 及小于 π , 相应地, 点 u 称为椭圆点、欧氏点和双曲点。



图 3.5. 直线穿过椭圆点或双曲点

椭圆点、欧氏点和双曲点在 3 维空间中均是可以实现的, 这里点的实现有别于欧氏空间的情形, 即不一定是平直的, 除非该点就是欧氏点。图 3.6 中给出了这三种点在 3 维空间的实现方法, 图中点 u 为椭圆点, v 为欧氏点而 w 为双曲点。

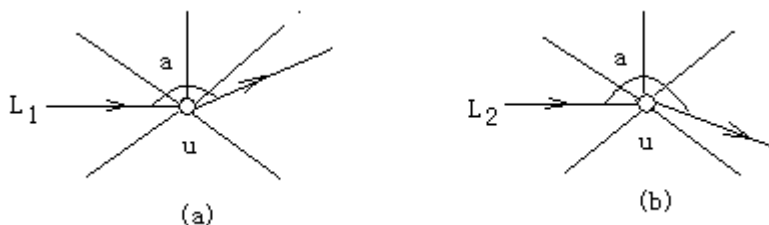

图 3.6. 椭圆点、欧氏点和双曲点在 3- 维空间的实现

定理 3.1 有界、无界地图几何中均存在悖论几何、非几何、反射影几何和反几何。

定理的证明见文献 [16]。为便于理解, 我们下面介绍平面地图几何的情形。在这种情形, 不仅可以在顶点上赋予角因子函数, 还可以要求连接顶点之间的边是一个连续函数, 这样对进一步理解平面上代数曲线十分有意义。比如在平面地图几何中有这样的结论:

平面地图几何无穷直线不穿过地图或穿过的点为欧氏点。

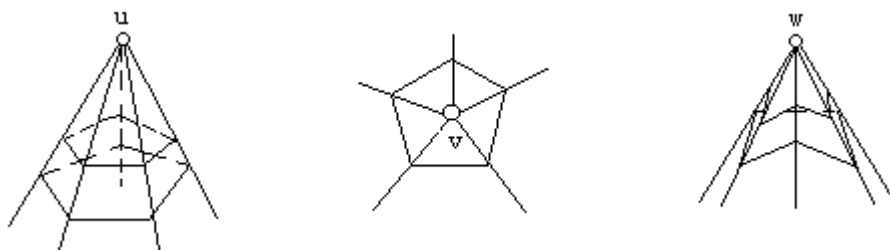
作为一个例子, 图 3.7 中画出了基于正四面体的一种平面地图几何, 其中顶点边上的数值表明该顶点 2 倍的角因子函数值。



图 3.7. 一个平面地图几何的例子

图 3.8 中画出了图 3.7 定义的平面地图几何中直线的情形，类似地，图 3.9 中画出了该平面地图几何中的几种多边形。



图 3.8. 平面地图几何的直线

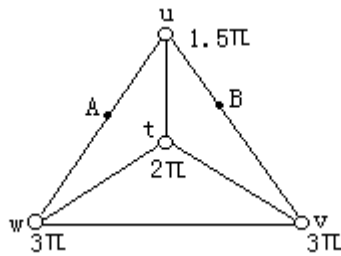

图 3.9. 平面地图几何的多边形

§4. 伪度量空间几何

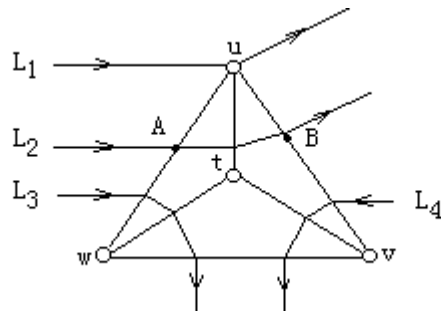
Einstein 的广义相对论断言了空间在引力作用下是弯曲的，甚至光线也不例外，这一点在实际观测中已经得到证实。地图几何的思想实际上可以一般地定义于一个度量空间上，即在该度量空间的每个点上赋予一个向量而建立伪度量空间几何。

定义 4.1 设 U 为一个度量为 ρ 的度量空间， $W \subseteq U$ 。对任意 $\forall u \in U$ ，若存在一个

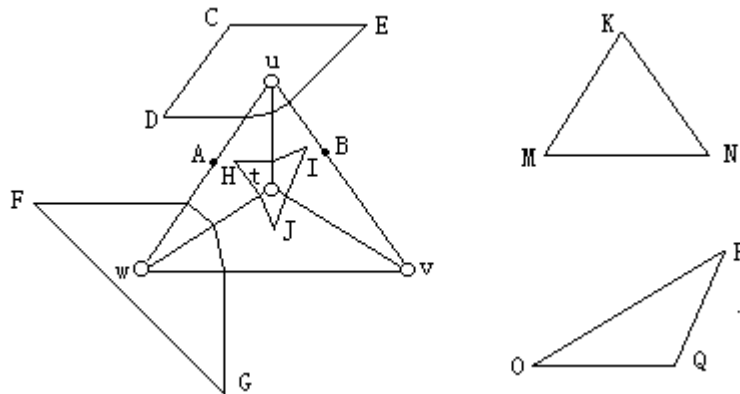
连续映射 $\omega : u \rightarrow \omega(u)$, 这里, 对任意整数 $n, n \geq 1$, $\omega(u) \in \mathbf{R}^n$ 使得对任意的正数 $\epsilon > 0$, 均存在一个数 $\delta > 0$ 和一个点 $v \in W$, $\rho(u-v) < \delta$ 使得 $\rho(\omega(u) - \omega(v)) < \epsilon$. 则若 $U = W$, 称 U 为一个伪度量空间, 记为 (U, ω) ; 若存在正数 $N > 0$ 使得 $\forall w \in W, \rho(w) \leq N$, 则称 U 为一个有界伪度量空间, 记为 (U^-, ω) .

注意 ω 是角因子函数时, 从伪度量空间我们得到 Einstein 的弯曲空间. 为便于理解, 我们讨论伪平面几何且 ω 为角因子函数的情形, 首先有下面两个简单的结论.

定理 4.1 过伪平面 (\mathcal{P}, ω) 上的两点 u 和 v 不一定存在欧氏意义上的直线.

定理 4.2 在一个伪平面 (Σ, ω) 上, 若不存在欧氏点, 则 (Σ, ω) 其每个点均为椭圆点或每个点均为双曲点.

对于平面代数曲线, 则有如下结果.

定理 4.3 在伪平面 (Σ, ω) 上存在代数曲线 $F(x, y) = 0$ 经过区域 D 中的点 (x_0, y_0) 当且仅当 $F(x_0, y_0) = 0$ 且对任意 $\forall (x, y) \in D$,

$$\left(\pi - \frac{\omega(x, y)}{2}\right)\left(1 + \left(\frac{dy}{dx}\right)^2\right) = \text{sign}(x, y).$$

现在, 我们再回到伪度量空间上. 依据定义 4.1, 对一个 m -流形 M^m 和任意点 $\forall u \in M^m$, 取 $U = W = M^m$, $n = 1$ 且 $\omega(u)$ 为一个光滑函数. 则我们得到流形 M^m 上的伪流形几何 (M^m, ω) .

我们知道, 流形 M^m 上的 Minkowski 范数定义为满足如下条件的一个函数 $F : M^m \rightarrow [0, +\infty)$.

- (i) F 在 $M^m \setminus \{0\}$ 上处处光滑;
- (ii) F 是 1- 齐次的, 即对任意的 $\bar{u} \in M^m$ 和 $\lambda > 0$, 有 $F(\lambda\bar{u}) = \lambda F(\bar{u})$;
- (iii) 对任意的 $\forall y \in M^m \setminus \{0\}$, 满足条件

$$g_y(\bar{u}, \bar{v}) = \frac{1}{2} \frac{\partial^2 F^2(y + s\bar{u} + t\bar{v})}{\partial s \partial t} \Big|_{t=s=0}$$

的对称双线性型 $g_y : M^m \times M^m \rightarrow R$ 是正定的.

Finsler 流形实际上就是赋予了 Minkowski 范数的流形, 具体来讲就是流形 M^m 及其切空间上的一个函数 $F : TM^m \rightarrow [0, +\infty)$ 并满足如下条件.

- (i) F 在 $TM^m \setminus \{0\} = \cup\{T_{\bar{x}}M^m \setminus \{0\} : \bar{x} \in M^m\}$ 上处处光滑;
- (ii) 对任意 $\forall \bar{x} \in M^m$, $F|_{T_{\bar{x}}M^m} \rightarrow [0, +\infty)$ 是一个 Minkowski 范数。

作为伪度量空间几何的一个特例, 对任意 $\bar{x} \in M^m$, 我们选择 $\omega(\bar{x}) = F(\bar{x})$ 。则伪度量空间几何 (M^m, ω) 是一个 Finsler 流形, 特别地, 如果取 $\omega(\bar{x}) = g_{\bar{x}}(y, y) = F^2(x, y)$, 则 (M^m, ω) 就是 Riemann 流形。这样, 我们就得到下述结论。

定理 4.4 伪度量空间几何 (M^m, ω) , 一般地, Smarandache 几何中包含 Finsler 几何, 从而包含 Riemann 几何。

§5. 需要进一步研究的问题

二十一世纪的理论物理为数学研究提出了大量需要研究的问题, 这里我们仅列举几个。

理论物理问题 5.1 有多少个宇宙? 为什么人类发现不了其他宇宙空间? 这是否与引力弯曲空间有关?

既然可以有无数个星球, 当然就允许有多个宇宙, 这就是文献 [10] 中平行宇宙的观点, 也是物理学界普遍接受的观点。Einstein 断言了空间在引力作用下是弯曲的, 从某种意义上讲欧氏空间在真实世界中是不存在的。从实验观测的角度, 人类仅能观测或测试到自然界中某种相而不是其本身, 无论是高维空间还是低维空间映射到 4 维空间, 文献 [16] 中对此已有些初步刻画。经典微分几何中利用切向量丛刻画弯曲的方法依赖于一些特定的联络规则。一般性的研究弯曲空间应彻底对伪度量空间 (M^m, ω) 进行研究。基于非平直空间的研究可以发现, 至少在数学上允许平行宇宙的存在, 但人类目前的观测方法无法观测到。

理论物理问题 5.2 人类生活的宇宙维数到底是多少? 是否有限?

二十世纪末理论物理的发展正在让人类改变数千年来形成的空间观念, 从而影响着数学的变革。一些著名的理论物理学家更直言不讳的说“我们甚至不知道人类空间的自由度到底是多少”。在当今理论与实验的条件下, 要搞清这个问题有一定的困难, 因为人类看不到、观测不到的东西太多了。弦理论中认为空间维数是 10, M-理论中的空间维数是 11 且五种已知的弦或超弦理论均是其极限情形。而少数物理学家正在研究的 F-理论的空间维数是 12。伴随着这种思想, 可以建立一般的空间维数理论研究 Einstein 场方程, 在这一点上, 数学家走在了物理学家的后面。

理论物理问题 5.3 人类能够接近或进入黑洞吗? 地球上是否存在一种生物可以从 4 维进入 3 维或从 3 维进入 2 维空间?

黑洞实际上是 Einstein 场方程在不同度规条件下的奇点解。一方面, 物理学家认为黑洞存在巨大的引力, 就连光线也不能例外, 任何物体不幸落入黑洞中均将被撕裂成为碎片 ([6]-[7]); 同时物理学家又猜测黑洞是连接不同宇宙、不同时空的桥梁, 因为人类了解的一切物理规律在黑洞内均失效。与黑洞相对的, 理论物理中还有一种白洞, 其特征是任何物体均无法进入白洞内。如果抛开黑洞、白洞个体, 我们会发现两者均是自守恒的, 吸引的同时就是排斥, 所以黑洞与白洞应该是一回事。这样人类, 特别是宇航员无需担心不小心掉进了黑洞。

多态物质在地球上普遍存在的, 如水、油、氮等。但刻画多态物质的理论, 不论是物理或是数学均未引起人们的足够认识。多年以来, 力学模型一直坚持物体运动中态不变这一个基本原则。从理论上认识时空穿梭, 必须搞清楚运动中态变化带来的问题, 即不稳定体的运动问题。由此带来的数学问题是 ([16]):

- (1) 依据结构力学, 确定哪些图是稳定的, 哪些是不稳定的并进行分类。
- (2) 将图嵌入到多维空间内, 研究其相空间变化规律。
- (3) 建立图的相空间运动力学。

对物理学来说, 需要在地球上寻找能够改变其态的生物, 进而发现其时空穿梭规律。

理论物理问题 5.4 人类在地球上可以找到暗物质吗?

暗物质与暗能量一直是物理学界的一个热门话题。伴随着人类对空间维数认识的变化, 这个问题也变得日益复杂。如果空间维数 ≥ 11 , 那么暗物质就不一定处在人类看得到的方向维上, 也不可能地球上找到它。所有这些都依赖于人类认识水平与实验技术的提高。

参考文献

- [1] A.D.Aleksandrov and V.A.Zalgaller, *Intrinsic Geometry of Surfaces*, American Mathematical Society, Providence, Rhode Island, 1976.
- [2] I.Antoniadis, Physics with large extra dimensions: String theory under experimental test, *Current Science*, Vol.81, No.12, 25(2001),1609-1613
- [3] 陈省身和陈维恒, 微分几何讲义, 北京大学出版社, 2001.

- [4] M.J.Duff, A layman's guide to M-theory, *arXiv: hep-th/9805177*, v3, 2 July(1998).
- [5] 费宝俊, 相对论与非欧几何, 科学出版社, 北京, 2005.
- [6] S.Hawking, 时间简史, 湖南科技出版社,2005.
- [7] S.Hawking, 果壳里的宇宙, 湖南科技出版社,2005.
- [8] H.Iseri, *Smarandache Manifolds*, American Research Press, Rehoboth, NM,2002.
- [9] H.Iseri, *Partially Paradoxist Smarandache Geometries*, <http://www.gallup.unm.edu/~smarandache/Howard-Iseri-paper.htm>.
- [10] M.Kaku, *Hyperspace: A Scientific Odyssey through Parallel Universe, Time Warps and 10th Dimension*, Oxford Univ. Press.
- [11] L.Kuciuk and M.Antholy, An Introduction to Smarandache Geometries, *Mathematics Magazine, Aurora, Canada*, Vol.12(2003)
- [12] Y.P.Liu, *Enumerative Theory of Maps*, Kluwer Academic Publishers, Dordrecht/ Boston/ London, 1999.
- [13] L.F.Mao, *On Automorphisms groups of Maps, Surfaces and Smarandache geometries*, *Sientia Magna*, Vol.1(2005), No.2, 55-73.
- [14] L.F.Mao, A new view of combinatorial maps by Smarandache's notion, *arXiv: math.GM/0506232*.
- [15] L.F.Mao, *Automorphism Groups of Maps, Surfaces and Smarandache Geometries*, American Research Press, 2005.
- [16] L.F.Mao, *Smarandache multi-space theory*, Hexis, Phoenix, AZ, 2006.
- [17] F.Smarandache, Mixed noneuclidean geometries, *eprint arXiv: math/0010119*, 10/2000.
- [18] F.Smarandache, *A Unifying Field in Logics. Neutrosopy: Neturosophic Probability, Set, and Logic*, American research Press, Rehoboth, 1999.
- [19] F.Smarandache, Neutrosophy, a new Branch of Philosophy, *Multi-Valued Logic*, Vol.8, No.3(2002)(special issue on Neutrosophy and Neutrosophic Logic), 297-384.
- [20] F.Smarandache, A Unifying Field in Logic: Neutrosophic Field, *Multi-Valued Logic*, Vol.8, No.3(2002)(special issue on Neutrosophy and Neutrosophic Logic), 385-438.

21math-001-003

A New View of Combinatorial Maps by Smarandache's Notion*

Linfan MAO

(Chinese Academy of Mathematics and System Science, Beijing 100080, P.R.China)

e-mail: maolinfan@163.com

Abstract: On a geometrical view, the conception of map geometries is introduced, which are a nice models of the Smarandache geometries, also new kind of and more general intrinsic geometry on surfaces. Results convincing one that map geometries are Smarandache geometries are obtained. Some open problems related combinatorial maps with the Riemann geometry and Smarandache geometries are also presented.

Smarandache 思想引发的组合地图研究新观念

摘要. 采用几何学的观点, 本文引入了地图几何的概念。作为一种 2- 维的 Smarandache 几何模型, 它同时又可以看作一种新的、更广泛的内蕴几何。本文证明了地图几何确实是 2- 维的 Smarandache 几何, 同时提出了一些关联组合地图与 Riemann 几何、Smarandache 几何需要进一步研究的问题。

Key Words: map, Smarandache geometry, model, classification.

AMS(2000): 05C15, 20H15, 51D99, 51M05

¹Reported at the *Chinese Academy of Mathematics and System Science* and the *Department of Applied Mathematics of Beijing Jiaotong University*.

²e-print: *arXiv*: math.GM/0506232.

1. What is a combinatorial map

A graph Γ is a 2-tuple (V, E) consists of a finite non-empty set V of vertices together with a set E of unordered pairs of vertices, i.e., $E \subseteq V \times V$. Often denoted by $V(\Gamma)$, $E(\Gamma)$ the vertex set and edge set of a graph Γ ([9]).

For example, the graph in the Fig.1 is a complete graph K_4 with vertex set $V = \{1, 2, 3, 4\}$ and edge set $E = \{12, 13, 14, 23, 24, 34\}$.

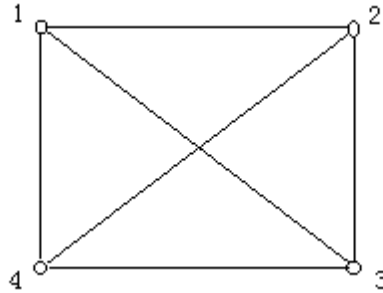

Fig.1

A map is a connected topological graph cellularly embedded in a surface. In 1973, Tutte gave an algebraic representation for embedding a graph on locally orientable surface ([18]), which transfer a geometrical partition of a surface to a kind of permutation in algebra as follows ([7][8]).

A *combinatorial map* $M = (\mathcal{X}_{\alpha,\beta}, \mathcal{P})$ is defined to be a basic permutation \mathcal{P} , i.e, for any $x \in \mathcal{X}_{\alpha,\beta}$, no integer k exists such that $\mathcal{P}^k x = \alpha x$, acting on $\mathcal{X}_{\alpha,\beta}$, the disjoint union of *quadrilaterals* Kx of $x \in X$ (the base set), where $K = \{1, \alpha, \beta, \alpha\beta\}$ is the *Klein group*, with the following two conditions holding:

(i) $\alpha\mathcal{P} = \mathcal{P}^{-1}\alpha$;

(ii) the group $\Psi_J = \langle \alpha, \beta, \mathcal{P} \rangle$ is transitive on $\mathcal{X}_{\alpha,\beta}$.

For a given map $M = (\mathcal{X}_{\alpha,\beta}, \mathcal{P})$, it can be shown that $M^* = (\mathcal{X}_{\beta,\alpha}, \mathcal{P}\alpha\beta)$ is also a map, call it the *dual* of the map M . The vertices of M are defined as the pairs of conjugacy orbits of \mathcal{P} action on $\mathcal{X}_{\alpha,\beta}$ by the condition (Ci) and edges the orbits of K on $\mathcal{X}_{\alpha,\beta}$, for example, for $\forall x \in \mathcal{X}_{\alpha,\beta}$, $\{x, \alpha x, \beta x, \alpha\beta x\}$ is an edge of the map M . Define the faces of M to be the vertices in the dual map M^* . Then the Euler characteristic $\chi(M)$ of the map M is

$$\chi(M) = \nu(M) - \varepsilon(M) + \phi(M)$$

where, $\nu(M), \varepsilon(M), \phi(M)$ are the number of vertices, edges and faces of the map M , respectively. For each vertex of a map M , its valency is defined to be the length of the orbits of \mathcal{P} action on a quadricell incident with u .

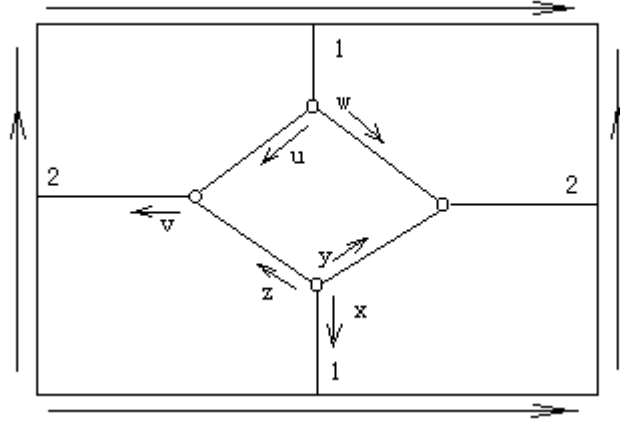

Fig.2

For example, the graph K_4 on the tours with one face length 4 and another 8 , shown in the Fig.2, can be algebraically represented as follows.

A map $(\mathcal{X}_{\alpha,\beta}, \mathcal{P})$ with $\mathcal{X}_{\alpha,\beta} = \{x, y, z, u, v, w, \alpha x, \alpha y, \alpha z, \alpha u, \alpha v, \alpha w, \beta x, \beta y, \beta z, \beta u, \beta v, \beta w, \alpha \beta x, \alpha \beta y, \alpha \beta z, \alpha \beta u, \alpha \beta v, \alpha \beta w\}$ and

$$\begin{aligned} \mathcal{P} = & (x, y, z)(\alpha \beta x, u, w)(\alpha \beta z, \alpha \beta u, v)(\alpha \beta y, \alpha \beta v, \alpha \beta w) \\ & \times (\alpha x, \alpha z, \alpha y)(\beta x, \alpha w, \alpha u)(\beta z, \alpha v, \beta u)(\beta y, \beta w, \beta v) \end{aligned}$$

The four vertices of this map are $\{(x, y, z), (\alpha x, \alpha z, \alpha y)\}, \{(\alpha \beta x, u, w), (\beta x, \alpha w, \alpha u)\}, \{(\alpha \beta z, \alpha \beta u, v), (\beta z, \alpha v, \beta u)\}$ and $\{(\alpha \beta y, \alpha \beta v, \alpha \beta w), (\beta y, \beta w, \beta v)\}$ and six edges are $\{e, \alpha e, \beta e, \alpha \beta e\}$, where, $e \in \{x, y, z, u, v, w\}$. The Euler characteristic $\chi(M)$ is $\chi(M) = 4 - 6 + 2 = 0$.

Geometrically, an embedding M of a graph Γ on a surface is a map and has an algebraic representation. The graph Γ is said the *underlying graph* of the map M and denoted by $\Gamma = \Gamma(M)$. For determining a given map $(\mathcal{X}_{\alpha,\beta}, \mathcal{P})$ is orientable or not, the following condition is needed.

(iii) If the group $\Psi_I = \langle \alpha\beta, \mathcal{P} \rangle$ is transitive on $\mathcal{X}_{\alpha,\beta}$, then M is non-orientable. Otherwise, orientable.

It can be shown that the number of orbits of the group $\Psi_I = \langle \alpha\beta, \mathcal{P} \rangle$ in the Fig.2 action on $\mathcal{X}_{\alpha,\beta} = \{x, y, z, u, v, w, \alpha x, \alpha y, \alpha z, \alpha u, \alpha v, \alpha w, \beta x, \beta y, \beta z, \beta u, \beta v, \beta w, \alpha\beta x, \alpha\beta y, \alpha\beta z, \alpha\beta u, \alpha\beta v, \alpha\beta w\}$ is 2. Whence, it is an orientable map and the genus of the surface is 1. Therefore, the algebraic representation is correspondent with its geometrical meaning.

2. What are lost in combinatorial maps

As we known, mathematics is a powerful tool of sciences for its unity and neatness, without any shade of mankind. On the other hand, it is also a kind of aesthetics deep down in one's mind. There is a famous proverb says that *only the beautiful things can be handed down to today*, which is also true for the mathematics.

Here, the term *unity* and *neatness* is relative and local, also have various conditions. For acquiring the target, many unimportant matters are abandoned in the process. Whether are those matters in this time still unimportant in another time? It is not true. That is why we need to think the question: *what are lost in the classical mathematics?*

For example, a compact surface is topological equivalent to a polygon with even number of edges by identifying each pairs of edges along a given direction on it([17]). If label each pair of edges by a letter $e, e \in \mathcal{E}$, a surface S is also identifying to a cyclic permutation such that each edge $e, e \in \mathcal{E}$ just appears two times in S , one is e and another is e^{-1} . Let a, b, c, \dots denote the letters in \mathcal{E} and A, B, C, \dots the sections of successive letters in linear order on a surface S (or a string of letters on S). Then, a surface can be represented as follows:

$$S = (\dots, A, a, B, a^{-1}, C, \dots),$$

where, $a \in \mathcal{E}$ and A, B, C denote a string of letters. Define three elementary transformations by

$$(O_1) \quad (A, a, a^{-1}, B) \Leftrightarrow (A, B);$$

$$(O_2) \quad (i) \quad (A, a, b, B, b^{-1}, a^{-1}) \Leftrightarrow (A, c, B, c^{-1});$$

- (ii) $(A, a, b, B, a, b) \Leftrightarrow (A, c, B, c)$;
- (O_3) (i) $(A, a, B, C, a^{-1}, D) \Leftrightarrow (B, a, A, D, a^{-1}, C)$;
- (ii) $(A, a, B, C, a, D) \Leftrightarrow (B, a, A, C^{-1}, a, D^{-1})$.

If a surface S_0 can be obtained by the elementary transformations O_1 - O_3 from a surface S , it is said that S is *elementary equivalent* with S_0 , denoted by $S \sim_{El} S_0$.

We have known the following formula in [8]:

- (i) $(A, a, B, b, C, a^{-1}, D, b^{-1}, E) \sim_{El} (A, D, C, B, E, a, b, a^{-1}, b^{-1})$;
- (ii) $(A, c, B, c) \sim_{El} (A, B^{-1}, C, c, c)$;
- (iii) $(A, c, c, a, b, a^{-1}, b^{-1}) \sim_{El} (A, c, c, a, a, b, b)$.

Then we can get the classification theorem of compact surfaces as follows([14]):

Any compact surface is homeomorphic to one of the following standard surfaces:

- (P_0) *the sphere: aa^{-1} ;*
- (P_n) *the connected sum of $n, n \geq 1$, tori:*

$$a_1 b_1 a_1^{-1} b_1^{-1} a_2 b_2 a_2^{-1} b_2^{-1} \cdots a_n b_n a_n^{-1} b_n^{-1};$$

- (Q_n) *the connected sum of $n, n \geq 1$, projective planes:*

$$a_1 a_1 a_2 a_2 \cdots a_n a_n.$$

Generally, a combinatorial map is a kind of decomposition of a surface. Notice that all the standard surfaces are just one face map underlying an one vertex graph. By a geometrical view, a combinatorial map is also a surface. But this assertion need more clarifying. For example, see the left graph Π_4 in the Fig. 3, which is just the tetrahedron.

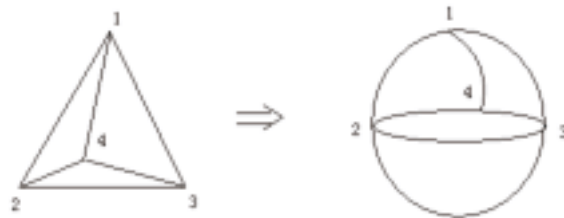

Fig.3

Whether can we say it is the sphere? Certainly NOT. Since any point u on a sphere has a neighborhood $N(u)$ homeomorphic to the open disc, therefore, all angles incident with the point 1 must all be 120° degree on a sphere. But in Π_4 , they are all 60° degree. For making them topologically same, i.e., homeomorphism, we must blow up the Π_4 to a sphere, as shown in the Fig.3. Whence, for getting the classification theorem of compact surfaces, we lose the *angle, area, volume, distance, curvature, ...*, etc, which are also lost in the combinatorial maps.

Klein Erlanger Program says that *any geometry is finding invariant properties under a transformation group of this geometry*. This is essentially the group action idea and widely used in mathematics today. In combinatorial maps, we know the following problems are applications of the Klein Erlanger Program:

- (i) to determine isomorphism maps or rooted maps;
- (ii) to determine equivalent embeddings of a graph;
- (iii) to determine an embedding whether exists;
- (iv) to enumerate maps or rooted maps on a surface;
- (v) to enumerate embeddings of a graph on a surface;
- (vi) ..., etc.

All the problems are extensively investigated by researches in the last century and papers related those problems are still appearing frequently on journals today. Then, *what are their importance to classical mathematics?* and *what are their contributions to sciences?* These are the central topics of this paper.

3. The Smarandache geometries

The *Smarandache geometries* is proposed by Smarandache in 1969 ([16]), which is a generalization of the classical geometries, i.e., the Euclid, Lobachevshy-Bolyai-Gauss and Riemannian geometries may be united altogether in a same space, by some Smarandache geometries. These last geometries can be either partially Euclidean and partially Non-Euclidean, or Non-Euclidean. It seems that the Smarandache geometries are connected with the *Relativity Theory* (because they include the Riemann geometry in a subspace) and with the *Parallel Universes* (because they combine separate spaces into one space) too([5]). For a detail illustration, we need to consider the classical geometries.

The axioms system of *Euclid geometry* are the following:

(A1) *there is a straight line between any two points.*

(A2) *a finite straight line can produce a infinite straight line continuously.*

(A3) *any point and a distance can describe a circle.*

(A4) *all right angles are equal to one another.*

(A5) *if a straight line falling on two straight lines make the interior angles on the same side less than two right angles, then the two straight lines, if produced indefinitely, meet on that side on which are the angles less than the two right angles.*

The axiom (A5) can be also replaced by:

(A5') *given a line l and a point u exterior this line, there is one line passing through u parallel to the line l .*

The Lobachevshy-Bolyai-Gauss geometry, also called hyperbolic geometry, is a geometry with axioms (A1) – (A4) and the following axiom (L5):

(L5) *there are infinitely many line parallels to a given line passing through an exterior point.*

The Riemann geometry, also called elliptic geometry, is a geometry with axioms (A1) – (A4) and the following axiom (R5):

there are no parallel to a given line passing through an exterior point.

By the thought of *Anti-Mathematics: not in a nihilistic way, but in a positive one, i.e., banish the old concepts by some new ones: their opposites*, Smarandache introduced the *paradoxist geometry, non-geometry, counter-projective geometry and anti-geometry* in [16] by contradicts the axioms (A1) – (A5) in Euclid geometry, generalized the classical geometries.

Paradoxist geometries

In these geometries, their axioms are (A1) – (A4) and with one of the following as the axiom (P5):

(i) *there are at least a straight line and a point exterior to it in this space for which any line that passes through the point and intersect the initial line.*

(ii) *there are at least a straight line and a point exterior to it in this space for*

which only one line passes through the point and does not intersect the initial line.

(iii) there are at least a straight line and a point exterior to it in this space for which only a finite number of lines $l_1, l_2, \dots, l_k, k \geq 2$ pass through the point and do not intersect the initial line.

(iv) there are at least a straight line and a point exterior to it in this space for which an infinite number of lines pass through the point (but not all of them) and do not intersect the initial line.

(v) there are at least a straight line and a point exterior to it in this space for which any line that passes through the point and does not intersect the initial line.

Non-Geometries

These non-geometries are geometries by denial some axioms of (A1) – (A5), such as:

(A1⁻) it is not always possible to draw a line from an arbitrary point to another arbitrary point.

(A2⁻) it is not always possible to extend by continuity a finite line to an infinite line.

(A3⁻) it is not always possible to draw a circle from an arbitrary point and of an arbitrary interval.

(A4⁻) not all the right angles are congruent.

(A5⁻) if a line, cutting two other lines, forms the interior angles of the same side of it strictly less than two right angle, then not always the two lines extended towards infinite cut each other in the side where the angles are strictly less than two right angle.

Counter-Projective geometries

Denoted by P the point set, L the line set and R a relation included in $P \times L$. A counter-projective geometry is a geometry with the following counter-axioms:

(C1) there exist: either at least two lines, or no line, that contains two given distinct points.

(C2) let p_1, p_2, p_3 be three non-collinear points, and q_1, q_2 two distinct points. Suppose that $\{p_1, q_1, p_3\}$ and $\{p_2, q_2, p_3\}$ are collinear triples. Then the line contain-

ing p_1, p_2 and the line containing q_1, q_2 do not intersect.

(C3) every line contains at most two distinct points.

Anti-Geometries

These geometries are constructed by denial some axioms of the Hilbert's 21 axioms of Euclidean geometry. As shown in [5], there are at least $2^{21} - 1$ anti-geometries.

The Smarandache geometries are defined as follows.

Definition 3.1 *An axiom is said Smarandachely denied if the axiom behaves in at least two different ways within the same space, i.e., validated and invalidated, or only invalidated but in multiple distinct ways.*

A Smarandache geometry is a geometry which has at least one Smarandachely denied axiom(1969).

A nice model for Smarandache geometries, called s -manifolds, is found by Iseri in [3] and [4], which is defined as follows:

An s -manifold is any collection $\mathcal{C}(T, n)$ of these equilateral triangular disks $T_i, 1 \leq i \leq n$ satisfying the following conditions:

(i) *each edge e is the identification of at most two edges e_i, e_j in two distinct triangular disks $T_i, T_j, 1 \leq i, j \leq n$ and $i \neq j$;*

(ii) *each vertex v is the identification of one vertex in each of five, six or seven distinct triangular disks.*

These vertices are classified by the number of the disks around them. A vertex around five, six or seven triangular disks is called an *elliptic vertex*, an *Euclid vertex* or a *hyperbolic vertex*, respectively.

An s -manifold is called closed if each edge is shared by exactly two triangular disks. An elementary classification for closed s -manifolds by triangulation are made in the reference [11]. These closed s -manifolds are classified into 7 classes in [11], as follows:

Classical Type:

(1) $\Delta_1 = \{5 - \text{regular triangular maps}\}$ (*elliptic*);

(2) $\Delta_2 = \{6 - \text{regular triangular maps}\}$ (*euclidean*);

(3) $\Delta_3 = \{7 - \text{regular triangular maps}\}$ (*hyperbolic*).

Smarandache Type:

- (4) $\Delta_4 = \{\text{triangular maps with vertex valency 5 and 6}\}$ (euclid-elliptic);
- (5) $\Delta_5 = \{\text{triangular maps with vertex valency 5 and 7}\}$ (elliptic-hyperbolic);
- (6) $\Delta_6 = \{\text{triangular maps with vertex valency 6 and 7}\}$ (euclid-hyperbolic);
- (7) $\Delta_7 = \{\text{triangular maps with vertex valency 5, 6 and 7}\}$ (mixed).

It is proved in [11] that $|\Delta_1| = 2$, $|\Delta_5| \geq 2$ and $|\Delta_i|, i = 2, 3, 4, 6, 7$ are infinite. Isier proposed a question in [3]: *do the other closed 2-manifolds correspond to s-manifolds with only hyperbolic vertices?* Since there are infinite Hurwitz maps, i.e., $|\Delta_3|$ is infinite, the answer is affirmative.

4. Map geometries

Combinatorial maps can be used to construct new geometries, which are nice models for the Smarandache geometries, also a generalization of Isier’s model and Poincaré’s model for the hyperbolic geometry.

4.1 Map geometries without boundary

For a given map on a surface, the map geometries without boundary are defined as follows.

Definition 4.1 *For a combinatorial map M with each vertex valency ≥ 3 , endows a real number $\mu(u), 0 < \mu(u) < \pi$, with each vertex $u, u \in V(M)$. Call (M, μ) a map geometry with out boundary, $\mu(u)$ the angle factor of the vertex u and to be orientable or non-orientable if M is orientable or not.*

The realization of each vertex $u, u \in V(M)$ in R^3 space is shown in the Fig.4 for each case of $\rho(u)\mu(u) > 2\pi, = 2\pi$ or $< 2\pi$.

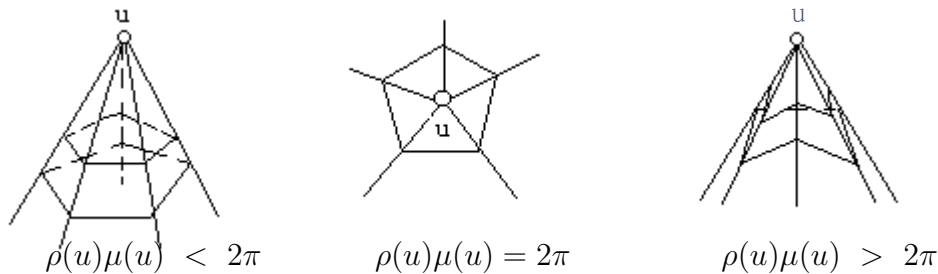

Fig.4

As pointed out in Section 2, this kind of realization is not a surface, but it is

homeomorphic to a surface. We classify points in a map geometry (M, μ) without boundary as follows.

Definition 4.2 *A point u in a map geometry (M, μ) is called elliptic, euclidean or hyperbolic if $\rho(u)\mu(u) < 2\pi$, $\rho(u)\mu(u) = 2\pi$ or $\rho(u)\mu(u) > 2\pi$.*

Then we have the following results.

Proposition 4.1 *Let M be a map with $\forall u \in V(M), \rho(u) \geq 3$. Then for $\forall u \in V(M)$, there is a map geometries (M, μ) without boundary such that u is elliptic, euclidean or hyperbolic in this geometry.*

Proof Since $\rho(u) \geq 3$, we can choose the angle factor $\mu(u)$ such that $\mu(u)\rho(u) < 2\pi$, $\mu(u)\rho(u) = 2\pi$ or $\mu(u)\rho(u) > 2\pi$. Notice that

$$0 < \frac{2\pi}{\rho(u)} < \pi.$$

Whence, we can also choose $\mu(u)$ satisfying that $0 < \mu(u) < \pi$ †

Proposition 4.2 *Let M be a map of order ≥ 3 and $\forall u \in V(M), \rho(u) \geq 3$. Then there exists a map geometry (M, μ) without boundary, in which all points are one of the elliptic vertices, euclidean vertices and hyperbolic vertices or their mixed.*

Proof According to the Proposition 4.1, we can choose an angle factor μ such that a vertex $u, u \in V(M)$ to be elliptic, or euclidean, or hyperbolic. Since $|V(M)| \geq 3$, we can also choose the angle factor μ such that any two vertices $v, w \in V(M) \setminus \{u\}$ to be elliptic, or euclidean, or hyperbolic as we wish. Then the map geometry (M, μ) makes the assertion holding. †

A *geodesic* in a manifold is a curve as straight as possible. Similarly, in a map geometry, its m -lines and m -points are defined as follows.

Definition 4.3 *Let (M, μ) be a map geometry without boundary. An m -line in (M, μ) is a curve with a constant curvature and points in it are called m -points.*

Examples for an m -line on the torus and Klein bottle are shown in Fig.5.

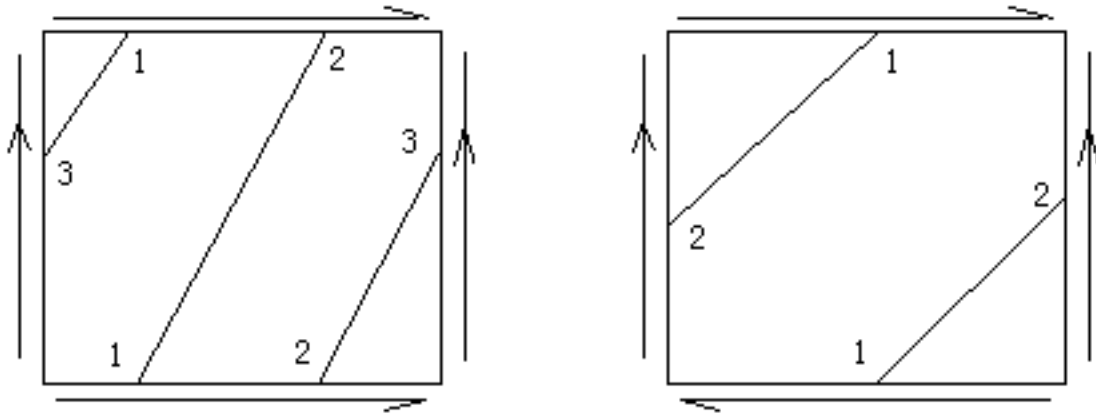
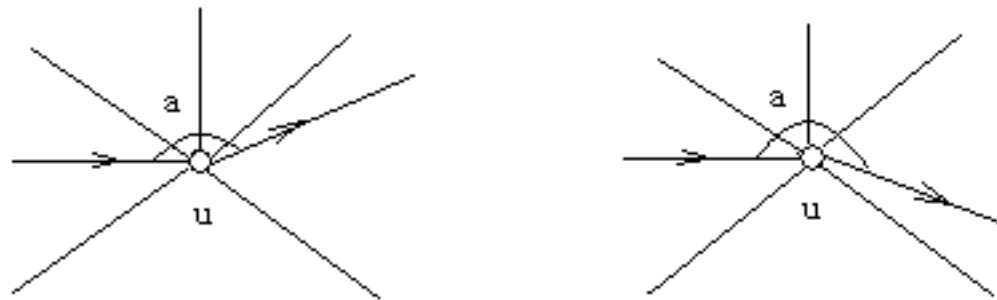

Fig.5

If an m -line pass through an elliptic point or a hyperbolic point u , it must has the angle $\frac{\mu(u)\rho(u)}{2}$ with the entering line, not 180° , which are explained in Fig.6.



$$a = \frac{\mu(u)\rho(u)}{2} < \pi$$

$$a = \frac{\mu(u)\rho(u)}{2} > \pi$$

Fig.6

The following proposition asserts that map geometries without boundary are Smarandache geometries.

Proposition 4.3 For a map M on a locally orientable surface with $order \geq 3$ and $vertex\ valency \geq 3$, there is an angle factor μ such that (M, μ) is a Smarandache geometry by denial the axiom (A5) with the axioms (A5), (L5) and (R5).

Proof According to Proposition 4.1, we know that there exist an angle factor μ such that there are elliptic vertices, euclidean vertices and hyperbolic vertices in (M, μ) simultaneously. The proof is divided into three cases.

Case 1. M is a planar map

Notice that for a given line L not pass through the vertices in the map M and a point u in (M, μ) , if u is an euclidean point, then there is one and only one line passing through u not intersecting with L , and if u is an elliptic point, then there are infinite lines passing through u not intersecting with L , but if u is a hyperbolic point, then each line passing through u will intersect with L , see also the Fig.7, in where, the planar graph is the complete graph K_4 and the points 1, 2 is elliptic vertices, the point 3 is euclidean and the point 4 hyperbolic. Then all m -lines in the filed A do not intersect with L and each m -line passing through the point 4 will intersect with the line L . Therefore, (M, μ) is a Smarandache geometry by denial the axiom (A5) with the axioms (A5). (L5) and (R5).

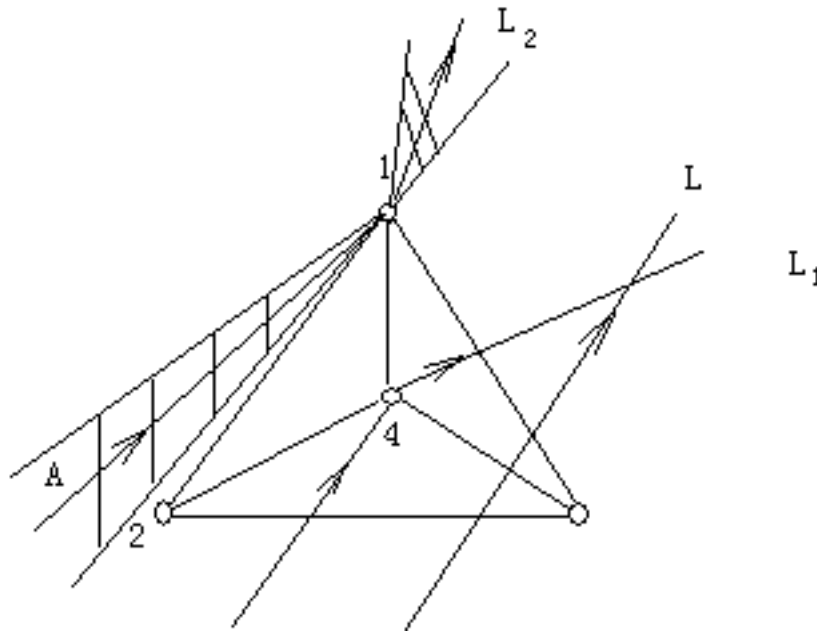

Fig.7

Case 2. M is an orientable map

According to the classification theorem of compact surfaces, We only need to

prove this result for the torus. Notice that on the torus, an m -line has the following properties ([15]):

If the slope ς of m -line L is a rational number, then L is a closed line on the torus. Otherwise, L is infinite, and moreover L passes arbitrarily close to every point of the torus.

Whence, if L_1 is an m -line on the torus, not passes through an elliptic or hyperbolic point, then for any point u exterior L_1 , we know that if u is an euclidean point, then there is only one m -line passing through u not intersecting with L_1 , and if u is elliptic or hyperbolic, then any m -line passing through u will intersect with L_1 .

Now let L_2 be an m -line passes through an elliptic or hyperbolic point, such as the m -line in Fig.8 and v an euclidean point.

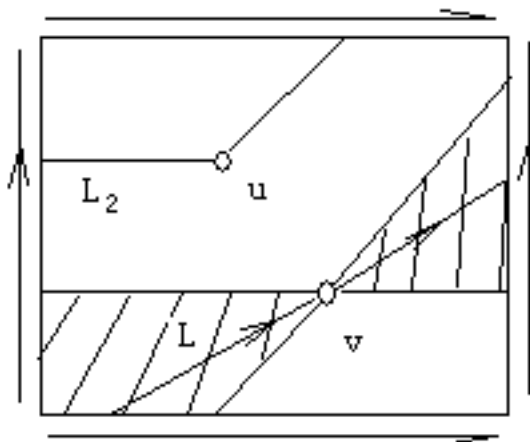

Fig.8

Then any m -line L in the shade filed passing through the point v will not intersect with L_2 . Therefore, (M, μ) is a Smarandache geometry by denial the axiom (A5) with the axioms (A5),(L5) and (R5).

Case 3. M is a non-orientable map

Similar to the Case 2, by the classification theorem of the compact surfaces, we only need to prove this result for the projective plane. An m -line in a projective plane is shown in the Fig.9, in where, case (a) is an m -line passes through euclidean points, (b) passes through an elliptic point and (c) passes through a hyperbolic

point.

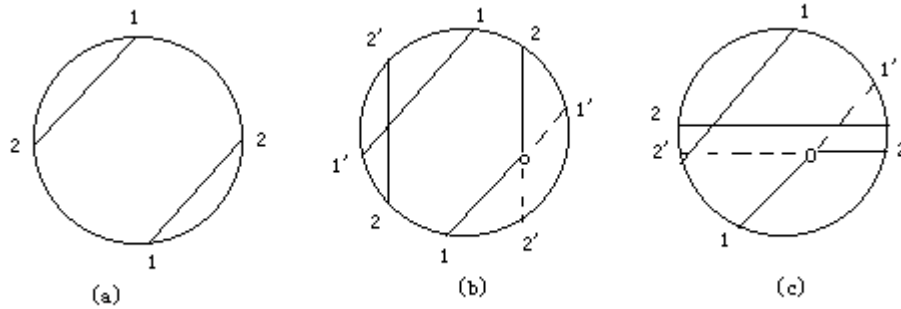

Fig.9

Now let the m -line passes through the center in the circle. Then if u is an euclidean point, there is only one m -line passing through u , see (a) in the Fig.10. If v is an elliptic point and there is an m -line passes through it and intersect with L , see (b) in Fig.10, assume the point 1 is a point such that the m -line $1v$ passes through 0, then any m -line in the shade of (b) passing through the point v will intersect with L .

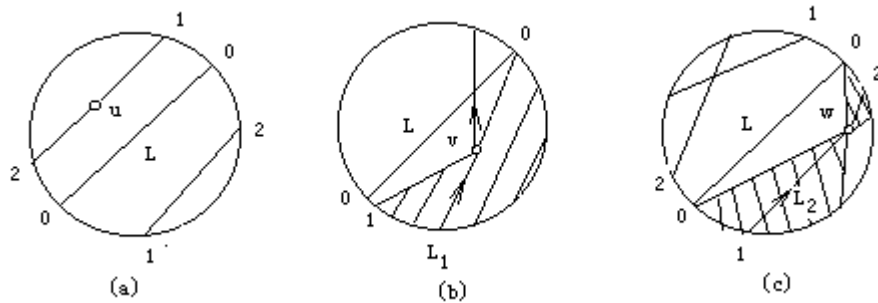

Fig.10

If w is a hyperbolic point and there is an m -line passing through it and does not intersect with L , see Fig.10(c), then any m -line in the shade of (c) passing through the point w will not intersect with L . Since the position of vertices of the map M on the projective plane can be choose as we wish, the proof is complete. \spadesuit .

4.2 Map geometries with boundary

The Poincaré's model for the hyperbolic geometry hints us to introduce the map geometries with boundary, which are defined as follows.

Definition 4.4 For a map geometry (M, μ) without boundary and faces $f_1, f_2, \dots, f_l \in F(M)$, $1 \leq l \leq \phi(M) - 1$, if $(M, \mu) \setminus \{f_1, f_2, \dots, f_l\}$ is connected, then call $(M, \mu)^{-l} = (M, \mu) \setminus \{f_1, f_2, \dots, f_l\}$ a map geometry with boundary f_1, f_2, \dots, f_l and orientable or not if (M, μ) is orientable or not.

A connected curve with constant curvature in $(M, \mu)^{-l}$ is called an m^- -line and points m^- -points.

Two m^- -lines on the torus and projective plane are shown in Fig.11 and Fig.12.

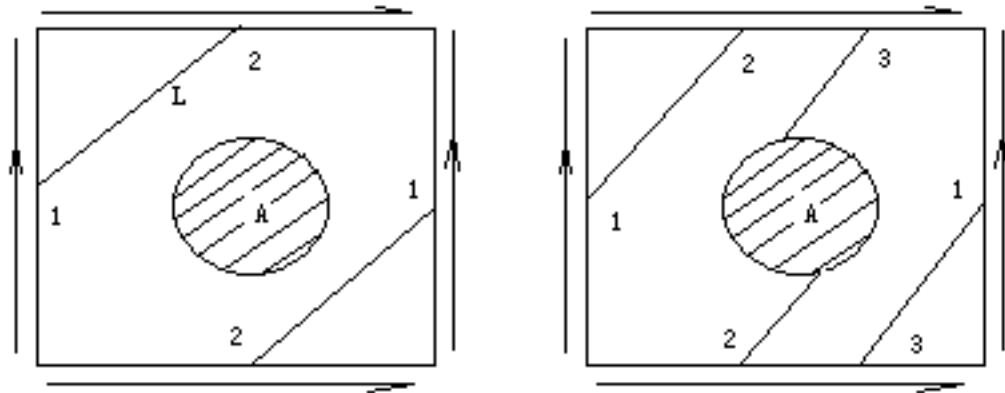

Fig.11

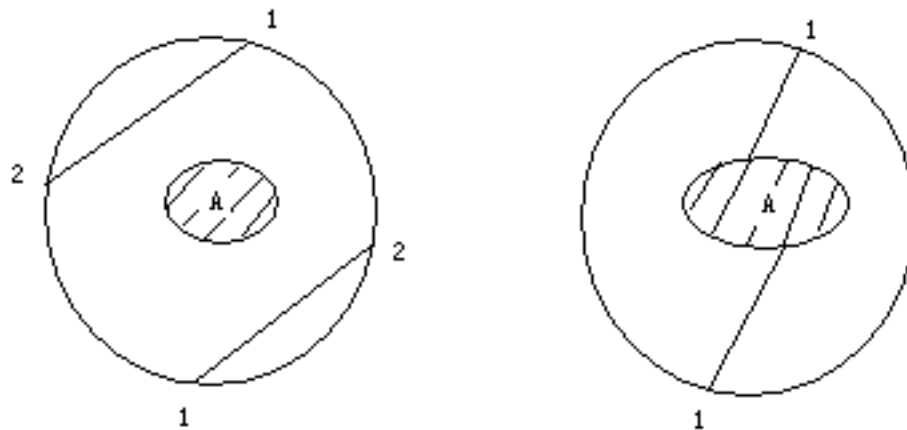

Fig.12

The map geometries with boundary also are Smarandache geometries, which is convince by the following result.

Proposition 4.4 *For a map M on a locally orientable surface with order ≥ 3 , vertex valency ≥ 3 and a face $f \in F(M)$, there is an angle factor μ such that $(M, \mu)^{-1}$ is a Smarandache geometry by denial the axiom (A5) with the axioms (A5), (L5) and (R5).*

Proof Similar to the proof of Proposition 4.3, consider the map M being a planar map, an orientable map on a torus or a non-orientable map on a projective plane, respectively. We get the assertion. \spadesuit

Notice that for an one face map geometry $(M, \mu)^{-1}$ with boundary, if we choose all points being euclidean, then $(M, \mu)^{-1}$ is just the Poincaré's model for the hyperbolic geometry.

4.3 Classification of map geometries

For the classification of map geometries, we introduce the following definition.

Definition 4.5 *Two map geometries (M_1, μ_1) , (M_2, μ_2) or $(M_1, \mu_1)^{-l}$, $(M_2, \mu_2)^{-l}$ are called to be equivalent if there is a bijection $\theta : M_1 \rightarrow M_2$ such that for $\forall u \in V(M)$, $\theta(u)$ is euclidean, elliptic or hyperbolic iff u is euclidean, elliptic or hyperbolic.*

The relation of the numbers of unrooted maps with the map geometries is in the following.

Proposition 4.5 *If \mathcal{M} is a set of non-isomorphisc maps with order n and m faces, then the number of map geometries without boundary is $3^n|\mathcal{M}|$ and the number of map geometries with one face being its boundary is $3^n m|\mathcal{M}|$.*

Proof By the definition, for a map $M \in \mathcal{M}$, there are 3^n map geometries without boundary and $3^n m$ map geometries with one face being its boundary by Proposition 4.3. Whence, we get $3^n|\mathcal{M}|$ map geometries without boundary and $3^n m|\mathcal{M}|$ map geometries with one face being its boundary from \mathcal{M} . \spadesuit

We have the following enumeration result for non-equivalent map geometries without boundary.

Proposition 4.6 *The numbers $n^O(\Gamma, g)$, $n^N(\Gamma, g)$ of non-equivalent orientable, non-orientable map geometries without boundary underlying a simple graph Γ by denial the axiom (A5) by (A5), (L5) or (R5) are*

$$n^O(\Gamma, g) = \frac{3^{|\Gamma|} \prod_{v \in V(\Gamma)} (\rho(v) - 1)!}{2|\text{Aut}\Gamma|},$$

and

$$n^N(\Gamma, g) = \frac{(2^{\beta(\Gamma)} - 1)3^{|\Gamma|} \prod_{v \in V(\Gamma)} (\rho(v) - 1)!}{2|\text{Aut}\Gamma|},$$

where $\beta(\Gamma) = \varepsilon(\Gamma) - \nu(\Gamma) + 1$ is the Betti number of the graph Γ .

Proof Denote by $\mathcal{M}(\Gamma)$ the set of all non-isomorphic maps underlying the graph Γ on locally orientable surfaces and by $\mathcal{E}(\Gamma)$ the set of all embeddings of the graph Γ on locally orientable surfaces. For a map M , $M \in \mathcal{M}(\Gamma)$, there are $\frac{3^{|M|}}{|\text{Aut}M|}$ different map geometries without boundary by choosing the angle factor μ on a vertex u such that u is euclidean, elliptic or hyperbolic. From permutation groups, we know that

$$|\text{Aut}\Gamma \times \langle \alpha \rangle| = |(\text{Aut}\Gamma)_M| |M^{\text{Aut}\Gamma \times \langle \alpha \rangle}| = |\text{Aut}M| |M^{\text{Aut}\Gamma \times \langle \alpha \rangle}|.$$

Therefore, we get that

$$\begin{aligned} n^O(\Gamma, g) &= \sum_{M \in \mathcal{M}(\Gamma)} \frac{3^{|M|}}{|\text{Aut}M|} \\ &= \frac{3^{|\Gamma|}}{|\text{Aut}\Gamma \times \langle \alpha \rangle|} \sum_{M \in \mathcal{M}(\Gamma)} \frac{|\text{Aut}\Gamma \times \langle \alpha \rangle|}{|\text{Aut}M|} \\ &= \frac{3^{|\Gamma|}}{|\text{Aut}\Gamma \times \langle \alpha \rangle|} \sum_{M \in \mathcal{M}(\Gamma)} |M^{\text{Aut}\Gamma \times \langle \alpha \rangle}| \\ &= \frac{3^{|\Gamma|}}{|\text{Aut}\Gamma \times \langle \alpha \rangle|} |\mathcal{E}^O(\Gamma)| \\ &= \frac{3^{|\Gamma|} \prod_{v \in V(\Gamma)} (\rho(v) - 1)!}{2|\text{Aut}\Gamma|}. \end{aligned}$$

Similarly, we get that

$$\begin{aligned} n^N(\Gamma, g) &= \frac{3^{|\Gamma|}}{|\text{Aut}\Gamma \times \langle \alpha \rangle|} |\mathcal{E}^N(\Gamma)| \\ &= \frac{(2^{\beta(\Gamma)} - 1)3^{|\Gamma|} \prod_{v \in V(\Gamma)} (\rho(v) - 1)!}{2|\text{Aut}\Gamma|}. \end{aligned}$$

This completes the proof. \square

For the classification of map geometries with boundary, we have the following result.

Proposition 4.7 *The numbers $n^O(\Gamma, -g)$, $n^N(\Gamma, -g)$ of non-equivalent orientable, non-orientable map geometries with one face being its boundary and underlying a simple graph Γ by denial the axiom (A5) by (A5), (L5) or (R5) are respective*

$$n^O(\Gamma, -g) = \frac{3^{|\Gamma|}}{2|\text{Aut}\Gamma|} [(\beta(\Gamma) + 1) \prod_{v \in V(\Gamma)} (\rho(v) - 1)! - \frac{2d(g[\Gamma](x))}{dx} \Big|_{x=1}]$$

and

$$n^N(\Gamma, -g) = \frac{(2^{\beta(\Gamma)} - 1)3^{|\Gamma|}}{2|\text{Aut}\Gamma|} [(\beta(\Gamma) + 1) \prod_{v \in V(\Gamma)} (\rho(v) - 1)! - \frac{2d(g[\Gamma](x))}{dx} \Big|_{x=1}],$$

where $g[\Gamma](x)$ is the genus polynomial of the graph Γ (see [12]), i.e., $g[\Gamma](x) = \sum_{k=\gamma(\Gamma)}^{\gamma_m(\Gamma)} g_k[\Gamma]x^k$ with $g_k[\Gamma]$ being the number of embeddings of Γ on the orientable surface of genus k .

Proof Notice that $\nu(M) - \varepsilon(M) + \phi(M) = 2 - 2g(M)$ for an orientable map M by the Euler characteristic. Similar to the proof of Proposition 4.6 with the notation $\mathcal{M}(\Gamma)$, by Proposition 4.5 we know that

$$\begin{aligned} n^O(\Gamma, -g) &= \sum_{M \in \mathcal{M}(\Gamma)} \frac{\phi(M)3^{|M|}}{|\text{Aut}M|} \\ &= \sum_{M \in \mathcal{M}(\Gamma)} \frac{(2 + \varepsilon(\Gamma) - \nu(\Gamma) - 2g(M))3^{|M|}}{|\text{Aut}M|} \\ &= \sum_{M \in \mathcal{M}(\Gamma)} \frac{(2 + \varepsilon(\Gamma) - \nu(\Gamma))3^{|M|}}{|\text{Aut}M|} - \sum_{M \in \mathcal{M}(\Gamma)} \frac{2g(M)3^{|M|}}{|\text{Aut}M|} \\ &= \frac{(2 + \varepsilon(\Gamma) - \nu(\Gamma))3^{|\Gamma|}}{|\text{Aut}\Gamma \times \langle \alpha \rangle|} \sum_{M \in \mathcal{M}(\Gamma)} \frac{|\text{Aut}\Gamma \times \langle \alpha \rangle|}{|\text{Aut}M|} \\ &\quad - \frac{2 \times 3^{|\Gamma|}}{|\text{Aut}\Gamma \times \langle \alpha \rangle|} \sum_{M \in \mathcal{M}(\Gamma)} \frac{g(M)|\text{Aut}\Gamma \times \langle \alpha \rangle|}{|\text{Aut}M|} \\ &= \frac{(\beta(\Gamma) + 1)3^{|\Gamma|}}{|\text{Aut}\Gamma \times \langle \alpha \rangle|} \sum_{M \in \mathcal{M}} (\Gamma) |M^{\text{Aut}\Gamma \times \langle \alpha \rangle}| \end{aligned}$$

$$\begin{aligned}
& - \frac{3^{|\Gamma|}}{|\text{Aut}\Gamma|} \sum_{M \in \mathcal{M}(\Gamma)} g(M) |M^{\text{Aut}\Gamma \times \langle \alpha \rangle}| \\
& = \frac{(\beta(\Gamma) + 1)3^{|\Gamma|}}{2|\text{Aut}\Gamma|} \prod_{v \in V(\Gamma)} (\rho(v) - 1)! - \frac{3^{|\Gamma|}}{|\text{Aut}\Gamma|} \sum_{k=\gamma(\Gamma)}^{\gamma_m(\Gamma)} k g_k[\Gamma] \\
& = \frac{3^{|\Gamma|}}{2|\text{Aut}\Gamma|} [(\beta(\Gamma) + 1) \prod_{v \in V(\Gamma)} (\rho(v) - 1)! - \frac{2d(g[\Gamma](x))}{dx} \Big|_{x=1}].
\end{aligned}$$

Notice that $n^L(\Gamma, -g) = n^O(\Gamma, -g) + n^N(\Gamma, -g)$ and the number of re-embeddings of an orientable map M on surfaces is $2^{\beta(M)}$ (see also [13]). We have that

$$\begin{aligned}
n^L(\Gamma, -g) & = \sum_{M \in \mathcal{M}(\Gamma)} \frac{2^{\beta(M)} \times 3^{|M|} \phi(M)}{|\text{Aut}M|} \\
& = 2^{\beta(M)} n^O(\Gamma, -g).
\end{aligned}$$

Whence, we get that

$$\begin{aligned}
n^N(\Gamma, -g) & = (2^{\beta(M)} - 1) n^O(\Gamma, -g) \\
& = \frac{(2^{\beta(M)} - 1)3^{|\Gamma|}}{2|\text{Aut}\Gamma|} [(\beta(\Gamma) + 1) \prod_{v \in V(\Gamma)} (\rho(v) - 1)! - \frac{2d(g[\Gamma](x))}{dx} \Big|_{x=1}].
\end{aligned}$$

This completes the proof. \square

4.4 Polygons in a map geometry

A k -polygon in a map geometry is a k -polygon with each line segment being m -lines or m^- -lines. For the sum of the internal angles in a k -polygon, we have the following result.

Proposition 4.8 *Let P be a k -polygon in a map geometry with each line segment passing through at most one elliptic or hyperbolic point. If H is the set of elliptic points and hyperbolic points on the line segment of P , then the sum of the internal angles in P is*

$$(k + |H| - 2)\pi - \frac{1}{2} \sum_{u \in H} \rho(u) \mu(u).$$

Proof Denote by U, V the sets of elliptic points and hyperbolic points in H and $|U| = p, |V| = q$. If an m -line segment passes through an elliptic point u , add an auxiliary line segment in the plane as shown in Fig.13(1). Then we get that

$$\text{angle } a = \text{angle}1 + \text{angle}2 = \pi - \frac{\rho(u)\mu(u)}{2}.$$

If an m -line passes through an hyperbolic point v , also add an auxiliary line segment in the plane as shown in Fig.13(2). Then we get that

$$\text{angle } b = \text{angle}3 + \text{angle}4 = \frac{\rho(v)\mu(v)}{2} - \pi.$$

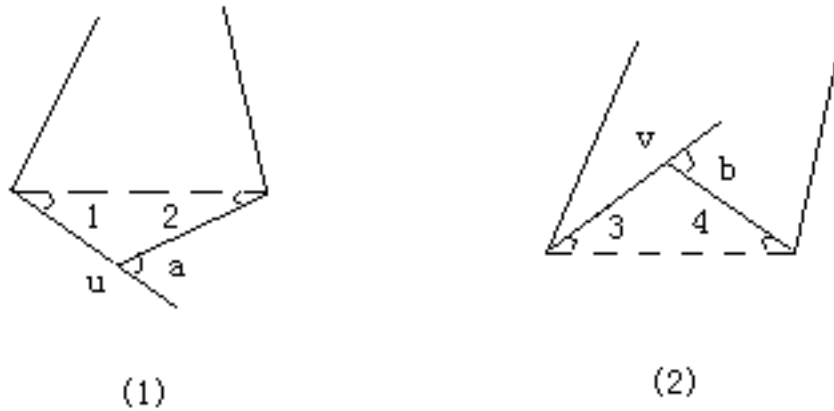

Fig.13

Since the sum of the internal angles of a k -polygon in the plane is $(k - 2)\pi$, we know that the sum of the internal angles in P is

$$\begin{aligned} & (k - 2)\pi + \sum_{u \in U} \left(\pi - \frac{\rho(u)\mu(u)}{2}\right) - \sum_{v \in V} \left(\frac{\rho(v)\mu(v)}{2} - \pi\right) \\ &= (k + p + q - 2)\pi - \frac{1}{2} \sum_{u \in H} \rho(u)\mu(u) \\ &= (k + |H| - 2)\pi - \frac{1}{2} \sum_{u \in H} \rho(u)\mu(u). \end{aligned}$$

This completes the proof. \spadesuit

As a corollary, we get the sum of the internal angles of a triangle in a map geometry as follows, which is consistent with the classical results.

Corollary 4.1 *Let Δ be a triangle in a map geometry. Then*

- (i) *if Δ is euclidean, then the sum of its internal angles is equal to π ;*
- (ii) *if Δ is elliptic, then the sum of its internal angles is less than π ;*
- (iii) *if Δ is hyperbolic, then the sum of its internal angles is more than π .*

5. Open problems for applying maps to classical geometries

Here is a collection of open problems concerned combinatorial maps with these Riemann geometry and Smarandache geometries. Although they are called open problems, in fact, any solution for one of these problems needs to establish a new mathematical system first.

5.1 The uniformization theorem for simple connected Riemann surfaces

The *uniformization theorem* for simple connected Riemann surfaces is one of those beautiful results in the Riemann surface theory, which is stated as follows([2]).

If \mathcal{S} is a simple connected Riemann surface, then \mathcal{S} is conformally equivalent to one and only one of the following three:

- (a) $\mathcal{C} \cup \infty$;
- (b) \mathcal{C} ;
- (c) $\Delta = \{z \in \mathcal{C} \mid |z| < 1\}$.

We have proved in [11] that any automorphism of a map is conformal. Therefore, we can also introduced the conformal mapping between maps. Then, *how can we define the conformal equivalence for maps enabling us to get the uniformization theorem of maps? What is the correspondent map classes with the three type (a) – (c) Riemann surfaces?*

5.2 Combinatorial construction of an algebraic curve of genus

A complex plane algebraic curve \mathcal{C}_l is a homogeneous equation $f(x, y, z) = 0$ in $P_2\mathcal{C} = (\mathcal{C}^2 \setminus (0, 0, 0)) / \sim$, where $f(x, y, z)$ is a polynomial in x, y and z with coefficients in \mathcal{C} . The degree of $f(x, y, z)$ is said the *degree of the curve \mathcal{C}_l* . For a Riemann surface S , a well-known result is ([2]) *there is a holomorphic mapping $\varphi : S \rightarrow P_2\mathcal{C}$ such that $\varphi(S)$ is a complex plane algebraic curve and*

$$g(S) = \frac{(d(\varphi(S)) - 1)(d(\varphi(S)) - 2)}{2}.$$

By map theory, we know a combinatorial map also is on a surface with genus. Then *whether can we get an algebraic curve by all edges in a map or by make operations on the vertices or edges of the map to get plane algebraic curve with given k -multiple points? and how do we find the equation $f(x, y, z) = 0$?*

5.3 Classification of s -manifolds by maps

We present an elementary classification for the closed s -manifolds in the Section 3. For the general s -manifolds, their correspondent combinatorial model is the maps on surfaces with boundary, founded by Bryant and Singerman in 1985 ([1]). The later are also related to the modular groups of spaces and need to investigate further themselves. The questions are

(i) *how can we combinatorially classify the general s -manifolds by maps with boundary?*

(ii) *how can we find the automorphism group of an s -manifold?*

(iii) *how can we know the numbers of non-isomorphic s -manifolds, with or without root?*

(iv) *find rulers for drawing an s -manifold on a surface, such as, the torus, the projective plane or Klein bottle, not only the plane.*

These s -manifolds only using triangulations of surfaces with vertex valency in $\{5, 6, 7\}$. Then *what are the geometrical meaning of the other maps, such as, the 4-regular maps on surfaces.* It is already known that the later is related to the Gauss cross problem of curves([9]).

5.4 Map geometries

As we have seen in the previous section, map geometries are nice models of the Smarandache geometries. More works should be done for them.

(i) *For a given graph G , determine properties of map geometries underlying G .*

(ii) *For a given locally orientable surface S , determine the properties of map*

geometries on S .

(iii) Classify map geometries on a locally orientable surface.

(iv) Enumerate non-equivalent map geometries underlying a graph or on a locally orientable surface.

(v) Establish the surface geometry by map geometries.

5.5 Gauss mapping among surfaces

In the classical differential geometry, a *Gauss mapping* among surfaces is defined as follows([10]):

Let $\mathcal{S} \subset R^3$ be a surface with an orientation \mathbf{N} . The mapping $N : \mathcal{S} \rightarrow R^3$ takes its value in the unit sphere

$$S^2 = \{(x, y, z) \in R^3 | x^2 + y^2 + z^2 = 1\}$$

along the orientation \mathbf{N} . The map $N : \mathcal{S} \rightarrow S^2$, thus defined, is called the *Gauss mapping*.

We know that for a point $P \in \mathcal{S}$ such that the Gaussian curvature $K(P) \neq 0$ and V a connected neighborhood of P with K does not change sign,

$$K(P) = \lim_{A \rightarrow 0} \frac{N(A)}{A},$$

where A is the area of a region $B \subset V$ and $N(A)$ is the area of the image of B by the Gauss mapping $N : \mathcal{S} \rightarrow S^2$. The questions are

(i) what is its combinatorial meaning of the Gauss mapping? How to realizes it by maps?

(ii) how can we define various curvatures for maps and rebuilt the results in the classical differential geometry?

5.6 The Gauss-Bonnet theorem

Let \mathcal{S} be a compact orientable surface. Then

$$\int \int_{\mathcal{S}} K d\sigma = 2\pi\chi(\mathcal{S}),$$

where K is the Gaussian curvature on \mathcal{S} .

This is the famous *Gauss-Bonnet theorem* for compact surface ([2], [6]). The questions are

(i) *what is its combinatorial meaning of the Gauss curvature?*

(ii) *how can we define the angle, area, volume, curvature, \dots , of a map?*

(iii) *can we rebuilt the Gauss-Bonnet theorem by maps? or can we get a generalization of the classical Gauss-Bonnet theorem by maps?*

5.7 Riemann manifolds

A Riemann surface is just a Riemann 2-manifold, which has become a source of the mathematical creative power. A *Riemann n -manifold* (M, g) is a n -manifold M with a Riemann metric g . Many important results in Riemann surfaces are generalized to Riemann manifolds with a higher dimension ([6]). For example, let \mathcal{M} be a complete, simple-connected Riemann n -manifold with constant sectional curvature c , then we know that \mathcal{M} is isometric to one of the model spaces \mathcal{R}^n , $S_{\mathcal{R}^n}$ or $H_{\mathcal{R}^n}$. *Whether can we systematically rebuilt the Riemann manifold theory by combinatorial maps? or can we make a combinatorial generalization of results in the Riemann geometry, for example, the Chern-Gauss-Bonnet theorem ([6])?*

References

- [1] R.P.Bryant and D.Singerman, Foundations of the theory of maps on surfaces with boundary, *Quart.J.Math.Oxford*(2),36(1985), 17-41.
- [2] H. M.Farkas and I. Kra, *Riemann Surfaces*, Springer-Verlag New York inc(1980).
- [3] H.Iseri, *Smarandache manifolds*, American Research Press, Rehoboth, NM,2002.
- [4] H.Iseri, *Partially Paradoxist Smarandache Geometries*, <http://www.gallup.unm.edu/~smarandache/Howard-Iseri-paper.htm>.
- [5] L.Kuciuk and M.Antholy, An Introduction to Smarandache Geometries, *Mathematics Magazine, Aurora, Canada*, Vol.12(2003)
- [6] J.M.Lee, *Riemann Manifolds*, Springer-Verlag New York,Inc(1997).
- [7] Y.P.Liu, *Advances in Combinatorial Maps*, Northern Jiaotong University Publisher, Beijing (2003).

- [8] Yanpei Liu, *Enumerative Theory of Maps*, Kluwer Academic Publisher, Dordrecht / Boston / London (1999).
- [9] Y.P.Liu, *Embeddability in Graphs*, Kluwer Academic Publisher, Dordrecht / Boston / London (1995).
- [10] Mantredo P.de Carmao, *Differential Geometry of Curves and Surfaces*, Pearson Education asia Ltd (2004).
- [11] L.F.Mao, *Automorphism groups of maps, surfaces and Smarandache geometries*, American Research Press, Rehoboth, NM,2005.
- [12] L.F.Mao and Y.P.Liu, A new approach for enumerating maps on orientable surfaces, *Australasian J. Combinatorics*, vol.30(2004), 247-259.
- [13] L.F.Mao and Y.P.Liu, Group action approach for enumerating maps on surfaces, *J.Applied Math. & Computing*, vol.13, No.1-2,201-215.
- [14] W.S.Massey, *Algebraic topology: an introduction*, Springer-Verlag, New York, etc.(1977).
- [15] V.V.Nikulin and I.R.Shafarevich, *Geometries and Groups*, Springer-Verlag Berlin Heidelberg (1987)
- [16] F. Smarandache, Mixed noneuclidean geometries, *eprint arXiv: math/0010119*, 10/2000.
- [17] J.Stillwell, *Classical topology and combinatorial group theory*, Springer-Verlag New York Inc., (1980).
- [18] W.T.Tutte, What is a maps? in *New Directions in the Theory of Graphs* (ed.by F.Harary), Academic Press (1973), 309 325.

21math-001-004

An Introduction to Smarandache Geometries on Maps*

Linfan Mao

(Chinese Academy of Mathematics and System Science, Beijing 100080, P.R.China)

maolinfan@163.com

Abstract: A map is a connected topological graph cellularly embedded in a surface. On the past century, works on maps are concentrated on its combinatorial counterpart without metrics, such as, the embedding of graphs and the enumeration of maps. For returning to its original face, the conception of map geometries is introduced, which are nice models of the Smarandache geometries, also a new kind of intrinsic geometry of surfaces. Some properties of parallel bundles in planar map geometries are obtained in this paper. Open problems related combinatorial maps with the differential geometry, Riemann geometry and Smarandache geometries are also presented for further applications of combinatorial maps to classical mathematics.

地图上的 Smarandache 几何引论

摘要. 地图是图在曲面上的 2-胞腔嵌入。二十世纪地图的研究主要集中在对其组合的、非度量性质，如图在曲面上的可嵌入性和地图计数的研究。为将地图应用于其他数学领域，我们引入了地图几何的概念。作为一种 2-维的 Smarandache 几何模型，它同时又是一种曲面内蕴几何。本文讨论了平面地图几何的一些初步性质。为进一步将地图应用于其他数学领域，提出了一些关联组合地图与微分几何、Riemann 几何和 Smarandache 几何需要进一步研究的问题。

¹Reported at *The 2005 International Conference on Graphs and Combinatorics*, June 26, 2005, Zhejiang, P.R.China

Key Words: map, Smarandache geometry, map geometry, planar map geometry, parallel bundle.

AMS(2000): 05C15, 20H15, 51D99, 51M05

1. Questions for a combinatorial problem

When we research a mathematical problem, the following four questions should be asked firstly by ourself, which is the same for a combinatorial problem.

- *What is its contribution to combinatorics?*
- *What is its contribution to mathematics?*
- *What is its contribution to sciences?*
- *Is its contribution local or global?*

The topic introduced in this report has stood a trial by the four questions.

2. What are Smarandache geometries?

Definition 2.1 *An axiom is said Smarandachely denied if the axiom behaves in at least two different ways within the same space, i.e., validated and invalidated, or only invalidated but in multiple distinct ways.*

A Smarandache geometry is a geometry which has at least one Smarandachely denied axiom (1969).

F. Smarandache, Mixed noneuclidean geometries, *eprint arXiv: math/0010119*, 10/2000.
L.F.Mao, *Automorphism groups of maps, surfaces and Smarandache geometries*, American Research Press, Rehoboth, NM,2005. Also see the web page: www.gallup.unm.edu/smarandache/Linfan.pdf

• Applications to classical geometries

The axioms system of *Euclid geometry* is in the following:

(A1) *there is a straight line between any two points.*

(A2) *a finite straight line can produce a infinite straight line continuously.*

(A3) *any point and a distance can describe a circle.*

(A4) *all right angles are equal to one another.*

(A5) *if a straight line falling on two straight lines make the interior angles on the same side less than two right angles, then the two straight lines, if produced*

indefinitely, meet on that side on which are the angles less than the two right angles.

The axiom (A5) can be also replaced by:

(A5') *given a line and a point exterior this line, there is one line parallel to this line.*

The *Lobachevshy-Bolyai-Gauss geometry*, also called hyperbolic geometry, is a geometry with axioms (A1) – (A4) and the following axiom (L5):

(L5) *there are infinitely many line parallels to a given line passing through an exterior point.*

The *Riemann geometry* is a geometry with axioms (A1) – (A4) and the following axiom (R5):

there is no parallel to a given line passing through an exterior point.

• Further applications

(1) **Relativity Theory** (*Because they include the Riemann geometry in a sub-space*)

(2) **Parallel Universes** (*Because they combine separate spaces into one space*)

L.Kuciuk and M.Antholy, An Introduction to Smarandache Geometries, *Mathematics Magazine, Aurora, Ca- nada*, Vol.12(2003)

• Iseri's model for Smarandache geometries

An s-manifold is any collection $\mathcal{C}(T, n)$ of these equilateral triangular disks $T_i, 1 \leq i \leq n$ satisfying the following conditions:

(i) *Each edge e is the identification of at most two edges e_i, e_j in two distinct triangular disks $T_i, T_j, 1 \leq i, j \leq n$ and $i \neq j$;*

(ii) *Each vertex v is the identification of one vertex in each of five, six or seven distinct triangular disks.*

H.Iseri, *Smarandache manifolds*, American Research Press, Rehoboth, NM, 2002.

3. What is a map?

A combinatorial map is a connected topological graph cellularly embedded in a surface.

Definition 3.1: *A combinatorial map $M = (\mathcal{X}_{\alpha, \beta}, \mathcal{P})$ is defined to be a basic per-*

mutation \mathcal{P} , i.e, for any $x \in \mathcal{X}_{\alpha,\beta}$, no integer k exists such that $\mathcal{P}^k x = \alpha x$, acting on $\mathcal{X}_{\alpha,\beta}$, the disjoint union of quadricells Kx of $x \in X$ (the base set), where $K = \{1, \alpha, \beta, \alpha\beta\}$ is the Klein group, with the following two conditions holding:

- (i) $\alpha\mathcal{P} = \mathcal{P}^{-1}\alpha$;
- (ii) the group $\Psi_J = \langle \alpha, \beta, \mathcal{P} \rangle$ is transitive on $\mathcal{X}_{\alpha,\beta}$.

W.T.Tutte, What is a maps? in *New Directions in the Theory of Graphs* (ed.by F.Harary), Academic Press (1973), 309 325.

Y.P.Liu, *Advances in Combinatorial Maps*(in Chinese), Northern Jiaotong University Publisher, Beijing (2003).

Y.P.Liu, *Enumerative Theory of Maps*, Kluwer Academic Publisher, Dordrecht / Boston / London (1999).

• **Orientation:**

If the group $\Psi_I = \langle \alpha\beta, \mathcal{P} \rangle$ is transitive on $\mathcal{X}_{\alpha,\beta}$, then M is non-orientable. Otherwise, orientable.

• **An Example of Maps: K_4 on the torus.**

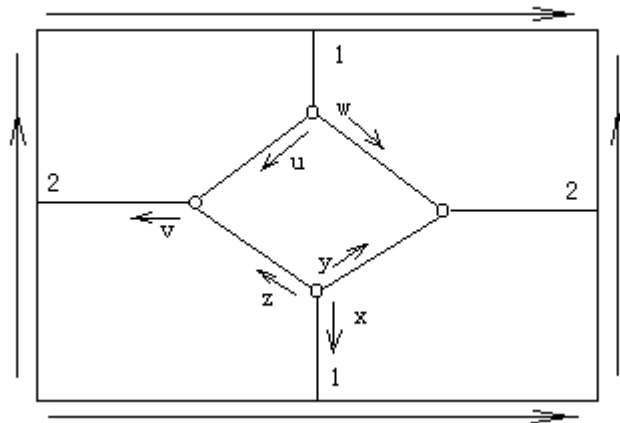

Fig.1

$$M = (\mathcal{X}_{\alpha,\beta}, \mathcal{P}):$$

$$\begin{aligned} \mathcal{X}_{\alpha,\beta} = \{ & x, y, z, u, v, w, \alpha x, \alpha y, \alpha z, \alpha u, \alpha v, \\ & \alpha w, \beta x, \beta y, \beta z, \beta u, \beta v, \beta w, \alpha\beta x, \alpha\beta y, \\ & \alpha\beta z, \alpha\beta u, \alpha\beta v, \alpha\beta w \} \end{aligned}$$

$$\begin{aligned} \mathcal{P} &= (x, y, z)(\alpha\beta x, u, w)(\alpha\beta z, \alpha\beta u, v) \\ &\times (\alpha\beta y, \alpha\beta v, \alpha\beta w)(\alpha x, \alpha z, \alpha y)(\beta x, \alpha w, \alpha u) \\ &\times (\beta z, \alpha v, \beta u)(\beta y, \beta w, \beta v) \end{aligned}$$

Vertices:

$$\begin{aligned} v_1 &= \{(x, y, z), (\alpha x, \alpha z, \alpha y)\} \\ v_2 &= \{(\alpha\beta x, u, w), (\beta x, \alpha w, \alpha u)\} \\ v_3 &= \{(\alpha\beta z, \alpha\beta u, v), (\beta z, \alpha v, \beta u)\} \\ v_4 &= \{(\alpha\beta y, \alpha\beta v, \alpha\beta w), (\beta y, \beta w, \beta v)\} \end{aligned}$$

Edges:

$$\{e, \alpha e, \beta e, \alpha\beta e\}, e \in \{x, y, z, u, v, w\}$$

Faces:

$$\begin{aligned} f_1 &= \{(x, u, v, \alpha\beta w, \alpha\beta x, y, \alpha\beta v, \alpha\beta z), (\beta x, \alpha z, \alpha v, \beta y, \alpha x, \alpha w, \beta v, \beta u)\} \\ f_2 &= \{(z, \alpha\beta u, w, \alpha\beta y), (\beta z, \alpha y, \beta w, \alpha u)\} \end{aligned}$$

4. Map geometries

Definition 4.1 For a combinatorial map M , endows a real number $\mu(u), 0 < \mu(u) < \pi$, with each vertex $u, u \in V(M)$. Call (M, μ) a map geometry without boundary, $\mu(u)$ the angle factor of the vertex u and to be orientable or non-orientable if M is orientable or not.

L.F.Mao, A new view of combinatorial maps by Smarandache's notion, arXiv: Math. GM/0506232.

- A realization of a vertex $u, u \in V(M)$ in R^3 space.

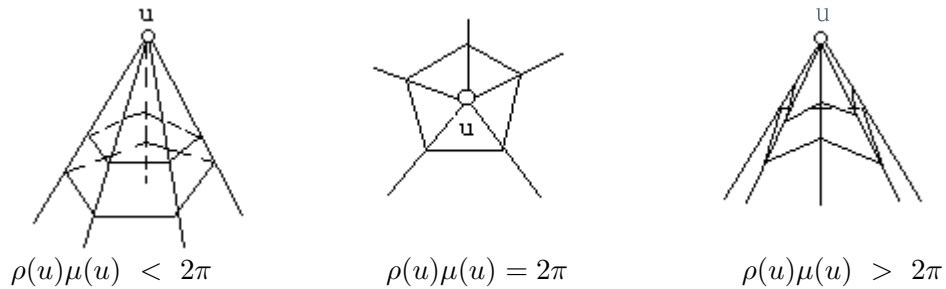

Fig.2

Theorem 4.1 For a map M on a locally orientable surface with order ≥ 3 , there is an angle factor μ such that (M, μ) is a Smarandache geometry by denial the axiom (A5) with the axioms (A5), (L5) and (R5).

Definition 4.2 For a map geometry (M, μ) without boundary and faces $f_1, f_2, \dots, f_l \in F(M)$, $1 \leq l \leq \phi(M) - 1$, if $(M, \mu) \setminus \{f_1, f_2, \dots, f_l\}$ is connected, then call $(M, \mu)^{-l} = (M, \mu) \setminus \{f_1, f_2, \dots, f_l\}$ a map geometry with boundary f_1, f_2, \dots, f_l and orientable or not if (M, μ) is orientable or not.

- An one face map geometry $(M, \mu)^{-1}$ with boundary is just the Poincaré's model for the hyperbolic geometry if we choose all points being euclidean.

Theorem 4.2 For a map M on a locally orientable surface with order ≥ 3 and a face $f \in F(M)$, there is an angle factor μ such that $(M, \mu)^{-1}$ is a Smarandache geometry by denial the axiom (A5) with the axioms (A5), (L5) and (R5).

- Map geometries are a generalization of s -manifolds.

- **Enumeration results for map geometries:**

Theorem 4.3 The numbers $n^O(\Gamma, g)$, $n^N(\Gamma, g)$ of non-equivalent orientable, non-orientable map geometries without boundary underlying a simple graph Γ by denial the axiom (A5) by (A5), (L5) or (R5) are

$$n^O(\Gamma, g) = \frac{3^{|\Gamma|} \prod_{v \in V(\Gamma)} (\rho(v) - 1)!}{2|\text{Aut}\Gamma|},$$

and

$$n^N(\Gamma, g) = \frac{(2^{\beta(\Gamma)} - 1)3^{|\Gamma|} \prod_{v \in V(\Gamma)} (\rho(v) - 1)!}{2|\text{Aut}\Gamma|},$$

where $\beta(\Gamma) = \varepsilon(\Gamma) - \nu(\Gamma) + 1$ is the Betti number of the graph Γ .

Similarly, we can also get enumeration results for map geometries with boundary.

5. Parallel bundles in planar map geometries

Definition 5.1 A family \mathcal{L} of infinite lines not intersecting each other in a planar geometry is called a parallel bundle.

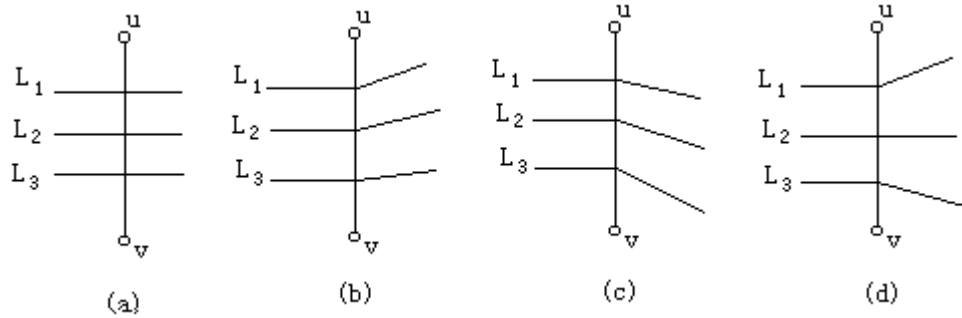

Fig.3

Theorem 5.1 Let (M, μ) be a planar map geometry, $C = \{u_1v_1, u_2v_2, \dots, u_lv_l\}$ a cut of the map M with order $u_1v_1, u_2v_2, \dots, u_lv_l$ from the left to the right, $l \geq 1$ and the angle functions on them are f_1, f_2, \dots, f_l , respectively, also see the Fig.4.

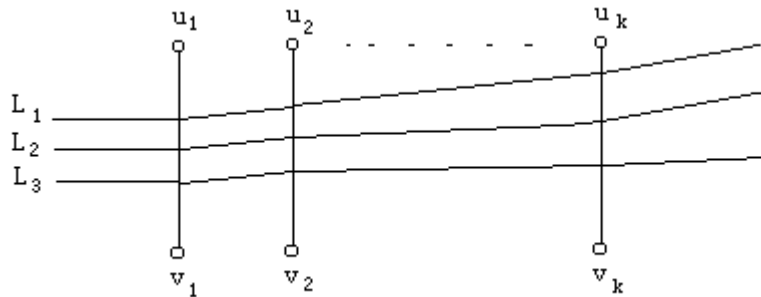

Fig.4

Then a family \mathcal{L} of parallel lines passing through C is a parallel bundle iff for any $x, x \geq 0$,

$$\begin{aligned}
 f'_1(x) &\geq 0 \\
 f'_{1+}(x) + f'_{2+}(x) &\geq 0 \\
 f'_{1+}(x) + f'_{2+}(x) + f'_{3+}(x) &\geq 0 \\
 &\dots\dots\dots \\
 f'_{1+}(x) + f'_{2+}(x) + \dots + f'_{i+}(x) &\geq 0.
 \end{aligned}$$

Theorem 5.2 Let (M, μ) be a planar map geometry, $C = \{u_1v_1, u_2v_2, \dots, u_lv_l\}$ a

cut of the map M with order $u_1v_1, u_2v_2, \dots, u_lv_l$ from the left to the right, $l \geq 1$ and the angle functions on them are f_1, f_2, \dots, f_l . Then the parallel lines parallel the initial parallel lines after them passing through C iff for $\forall x \geq 0$,

$$\begin{aligned} f'_1(x) &\geq 0 \\ f'_{1+}(x) + f'_{2+}(x) &\geq 0 \\ f'_{1+}(x) + f'_{2+}(x) + f'_{3+}(x) &\geq 0 \\ &\dots\dots\dots \\ f'_{1+}(x) + f'_{2+}(x) + \dots + f'_{l-1+}(x) &\geq 0 \end{aligned}$$

and

$$f_1(x) + f_2(x) + \dots + f_l(x) = l\pi.$$

• **Linear criterion**

Theorem 5.3 Let (M, μ) be a planar map geometry, $C = \{u_1v_1, u_2v_2, \dots, u_lv_l\}$ a cut of the map M with order $u_1v_1, u_2v_2, \dots, u_lv_l$ from the left to the right, $l \geq 1$. Then under the linear assumption, a family L of parallel lines passing through C is a parallel bundle iff the angle factor μ satisfies the following linear inequality system

$$\begin{aligned} \rho(v_1)\mu(v_1) &\geq \rho(u_1)\mu(u_1) \\ \frac{\rho(v_1)\mu(v_1)}{d(u_1v_1)} + \frac{\rho(v_2)\mu(v_2)}{d(u_2v_2)} &\geq \frac{\rho(u_1)\mu(u_1)}{d(u_1v_1)} + \frac{\rho(u_2)\mu(u_2)}{d(u_2v_2)} \\ &\dots\dots\dots \end{aligned}$$

$$\frac{\rho(v_1)\mu(v_1)}{d(u_1v_1)} + \frac{\rho(v_2)\mu(v_2)}{d(u_2v_2)} + \dots + \frac{\rho(v_l)\mu(v_l)}{d(u_lv_l)} \geq \frac{\rho(u_1)\mu(u_1)}{d(u_1, v_1)} + \dots + \frac{\rho(u_l)\mu(u_l)}{d(u_l, v_l)}.$$

Corollary 5.1 Let (M, μ) be a planar map geometry with M underlying a regular graph, $C = \{u_1v_1, u_2v_2, \dots, u_lv_l\}$ a cut of the map M with order $u_1v_1, u_2v_2, \dots, u_lv_l$

from the left to the right, $l \geq 1$. Then under the linear assumption, a family L of parallel lines passing through C is a parallel bundle iff the angle factor μ satisfies the following linear inequality system

$$\mu(v_1) \geq \mu(u_1)$$

$$\frac{\mu(v_1)}{d(u_1v_1)} + \frac{\mu(v_2)}{d(u_2v_2)} \geq \frac{\mu(u_1)}{d(u_1v_1)} + \frac{\mu(u_2)}{d(u_2v_2)}$$

.....

$$\frac{\mu(v_1)}{d(u_1v_1)} + \frac{\mu(v_2)}{d(u_2v_2)} + \dots + \frac{\mu(v_l)}{d(u_lv_l)} \geq \frac{\mu(u_1)}{d(u_1v_1)} + \frac{\mu(u_2)}{d(u_2v_2)} + \dots + \frac{\mu(u_l)}{d(u_lv_l)}$$

and particularly, if assume that all the lengths of edges in C are the same, then

$$\mu(v_1) \geq \mu(u_1)$$

$$\mu(v_1) + \mu(v_2) \geq \mu(u_1) + \mu(u_2)$$

.....

$$\mu(v_1) + \mu(v_2) + \dots + \mu(v_l) \geq \mu(u_1) + \mu(u_2) + \dots + \mu(u_l).$$

Theorem 5.4 Let (M, μ) be a planar map geometry, $C = \{u_1v_1, u_2v_2, \dots, u_lv_l\}$ a cut of the map M with order $u_1v_1, u_2v_2, \dots, u_lv_l$ from the left to the right, $l \geq 1$. If for any integer $i, i \geq 1$,

$$\frac{\rho(u_i)}{\rho(v_i)} \leq \frac{\mu(v_i)}{\mu(u_i)},$$

then under the linear assumption, a family L of parallel lines passing through C is a parallel bundle.

- A example of parallel bundle:

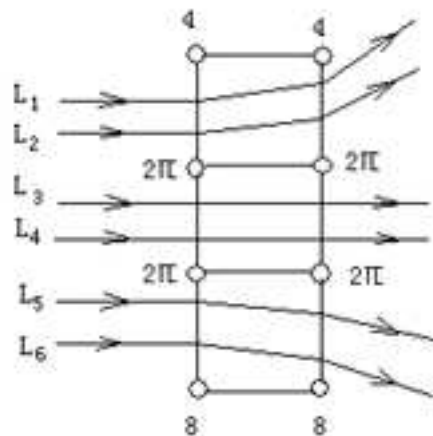

Fig.5

More results for parallel bundles can be seen in:

Linfan Mao, Parallel bundles in planar map geometries, *e-print: arXiv: math.GM/0506386*, also appearing in *Scientia Magna*, Vol.1(2005), No.2,120-133.

6. Open Problems

• The uniformization theorem for simple connected Riemann surfaces:

If S is a simple connected Riemann surface, then S is conformally equivalent to one and only one of the following three:

- (a) $\mathcal{C} \cup \infty$;
- (b) \mathcal{C} ;
- (c) $\Delta = \{z \in \mathcal{C} \mid |z| < 1\}$.

Problem 6.1: *How can we define the conformal equivalence for maps enabling us to get the uniformization theorem of maps?*

Problem 6.2 *What is the correspondence class maps with the three type (a) – (c) Riemann surfaces?*

• The Gauss-Bonnet Theorem

Let S be a compact orientable surface. Then

$$\int \int_{\mathcal{S}} K d\sigma = 2\pi\chi(\mathcal{S}),$$

where K is Gaussian curvature on \mathcal{S} .

Problem 6.3 *What is its combinatorial meaning of the Gauss curvature?*

Problem 6.4 *How can we define the angle, area, volume, curvature, \dots , of a map?*

Problem 6.5 *Can we rebuilt the Gauss-Bonnet theorem by maps? Or can we get a generalization of the classical Gauss-Bonnet theorem by maps?*

• **Map Geometries**

Problem 6.6 *For a given graph, determine the properties of map geometries underlying this graph.*

Problem 6.7 *For a given locally orientable surface, determine the properties of map geometries on this surface.*

Problem 6.8 *Classify map geometries on a given locally orientable surface.*

Problem 6.9 *Enumerate non-equivalent map geometries underlying a graph or on a locally orientable surface.*

Problem 6.10 *Establish the surface geometry by map geometries.*

21math-001-005

A Multi-Space Model for Chinese Bids Evaluation with Analyzing*

Linfan Mao

Chinese Academy of Mathematics and System Sciences, Beijing 100080, P.R.China

maolinfan@163.com

Abstract. A tendering is a negotiating process for a contract through by a tenderer issuing an invitation, bidders submitting bidding documents and the tenderer accepting a bidding by sending out a notification of award. As a useful way of purchasing, there are many norms and rulers for it in the purchasing guides of the World Bank, the Asian Development Bank, \dots , also in contract conditions of various consultant associations. In China, there is a law and regulation system for tendering and bidding. However, few works on the mathematical model of a tendering and its evaluation can be found in publication. The main purpose of this paper is to construct a Smarandache multi-space model for a tendering, establish an evaluation system for bidding based on those ideas in the references [7] and [8] and analyze its solution by applying the decision approach for multiple objectives and value engineering. Open problems for pseudo-multi-spaces are also presented in the final section.

招标评价体系的重空间模型及求解分析

摘要. 招标是招标人发出邀约邀请, 投标人依据邀请递交邀约, 招标人发出中标通知书承诺邀约的一种合同谈判过程。作为采购的一种方式, 世界性金融组织和工程咨询协会在其采购指南中对招标的行为准则进行了规定, 在中国则将这种市场行为上升到了法律, 形成了中国招标投标法律法规体系。虽如此, 对招标投标模型及其评价体系的研究一直处在初

¹e-print: *arXiv*: math.GM/0605495.

级阶段, 缺乏统一的理论体系。本文的主要目的在于依据作者新近在美国出版的两本专著 [7][8], 建立其评价体系的 Smarandache 重空间模型, 并采用多目标决策方法和价值工程理论对其进行求解分析, 建立招标投标的数学理论。文章最后提出了关于伪重空间的几个数学问题, 为进一步应用本文中的思想于多目标决策指出了方向。

Key Words: tendering, bidding, evaluation, Smarandache multi-space, condition of successful bidding, decision of multiple objectives, decision of simply objective, pseudo-multiple evaluation, pseudo-multi-space.

AMS(2000): 90B50,90C35,90C90

§1. Introduction

The tendering is an efficient way for purchasing in the market economy. According to the *Contract Law of the People's Republic of China* (Adopted at the second meeting of the Standing Committee of the 9th National People's Congress on March 15,1999), it is just a civil business through by a tenderer issuing a tendering announcement or an invitation, bidders submitting bidding documents compiled on the tendering document and the tenderer accepting a bidding after evaluation by sending out a notification of award. The process of this business forms a negotiating process of a contract. In China, there is an interval time for the acceptation of a bidding and becoming effective of the contract, i.e., the bidding is accepted as the tenderer send out the notification of award, but the contract become effective only as the tenderer and the successful bidder both sign the contract.

In the *Tendering and Bidding Law of the People's Republic of China* (Adopted at the 11th meeting of the Standing Committee of the 9th National People's Congress on August 30,1999), the programming and liability or obligation of the tenderer, the bidders, the bid evaluation committee and the government administration are stipulated in detail step by step. According to this law, the tenderer is on the side of raising and formulating rulers for a tender project and the bidders are on the side of response each ruler of the tender. Although the bid evaluation committee is organized by the tenderer, its action is independent on the tenderer. In tendering and bidding law and regulations of China, it is said that any unit or person can not disturbs works of the bid evaluation committee illegally. The action of them should consistent with the tendering and bidding law of China and they should place

themselves under the supervision of the government administration.

The role of each partner can be represented by a tetrahedron such as those shown in Fig. 1

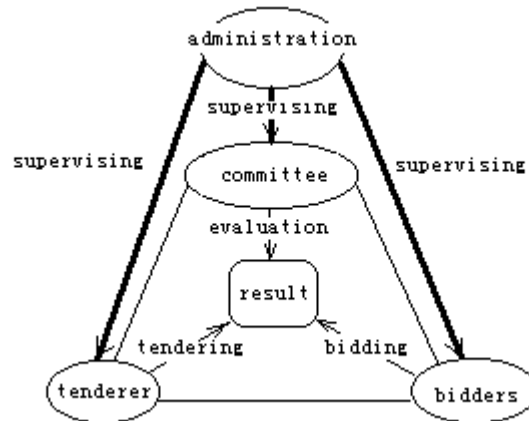

Fig.1

The 41th item in the *Tendering and Bidding Law of the People's Republic of China* provides conditions for a successful bidder:

- (1) optimally responsive all of the comprehensive criterions in the tendering document;
- (2) substantially responsive criterions in the tender document with the lowest evaluated bidding price unless it is lower than this bidder's cost.

The conditions (1) and (2) are often called the *comprehensive evaluation method* and the *lowest evaluated price method*. In the same time, these conditions also imply that the tendering system in China is a multiple objective system, not only evaluating in the price, but also in the equipments, experiences, achievements, staff and the programme, etc.. However, nearly all the encountered evaluation methods in China do not apply the scientific decision of multiple objectives. In where, the *comprehensive evaluation method* is simply replaced by the *100 marks* and the *lowest evaluated price method* by the *lowest bidding price method*. Regardless of whether different objectives being comparable, there also exist problems for the ability of bidders and specialists in the bid evaluation committee creating a false impression for the successful bidding price or the successful bidder. The tendering and bidding is badly in need of establishing a scientific evaluation system in accordance with these laws and regulations in China. Based on the reference [7] for Smarandache multi-spaces and the mathematical model for the tendering in [8], the main purpose

of this paper is to establish a multi-space model for the tendering and a scientific evaluation system for bids by applying the approach in the multiple objectives and value engineering, which enables us to find a scientific approach for tendering and its management in practice. Some cases are also presented in this paper.

The terminology and notations are standard in this paper. For terminology and notation not defined in this paper can be seen in [7] for multi-spaces, in [1] – [3] and [6] for programming, decision and graphs and in [8] for the tendering and bidding laws and regulations in China.

§2. A multi-space model for tendering

Under an idea of anti-thought or paradox for mathematics :*combining different fields into a unifying field*, Smarandache introduced the conception of multi-spaces in 1969([9]-[12]), including algebraic multi-spaces and multi-metric spaces. The contains the well-known Smarandache geometries([5] – [6]), which can be used to *General Relativity* and *Cosmological Physics*([7]). As an application to *Social Sciences*, multi-spaces can be also used to establish a mathematical model for tendering.

These algebraic multi-spaces are defined in the following definition.

Definition 2.1 *An algebraic multi-space \sum with multiple m is a union of m sets A_1, A_2, \dots, A_m*

$$\sum = \bigcup_{i=1}^m A_i,$$

where $1 \leq m < +\infty$ and there is an operation or ruler \circ_i on each set A_i such that (A_i, \circ_i) is an algebraic system for any integer $i, 1 \leq i \leq m$.

Notice that if $i \neq j, 1 \leq i, j \leq m$, there must not be $A_i \cap A_j = \emptyset$, which are just correspondent with the characteristics of a tendering. Thereby, we can construct a Smarandache multi-space model for a tendering as follows.

Assume there are m evaluation items A_1, A_2, \dots, A_m for a tendering \tilde{A} and there are n_i evaluation indexes $a_{i1}, a_{i2}, \dots, a_{in_i}$ for each evaluation item $A_i, 1 \leq i \leq m$. By applying mathematics, this tendering can be represented by

$$\tilde{A} = \bigcup_{i=1}^m A_i,$$

where, for any integer $i, 1 \leq i \leq m$,

$$(A_i, \circ_i) = \{a_{i1}, a_{i2}, \dots, a_{in_i} | \circ_i\}$$

is an algebraic system. Notice that we do not define other relations of the tendering \tilde{A} and evaluation indexes a_{ij} with $A_i, 1 \leq i \leq m$ unless $A_i \subseteq \tilde{A}$ and $a_{ij} \in A_i$ in this multi-space model.

Now assume there are $k, k \geq 3$ bidders R_1, R_2, \dots, R_k in the tendering \tilde{A} and the bidding of bidder $R_j, 1 \leq j \leq k$ is

$$R_j(\tilde{A}) = R_j \begin{pmatrix} A_1 \\ A_2 \\ \dots \\ A_m \end{pmatrix} = \begin{pmatrix} R_j(A_1) \\ R_j(A_2) \\ \dots \\ R_j(A_m) \end{pmatrix}$$

.

According to the successful bidding criterion in the *Tendering and Bidding Law of the People's Republic of China* and regulations, the bid evaluation committee needs to determine indexes i_1, i_2, \dots, i_k , where $\{i_1, i_2, \dots, i_k\} = \{1, 2, \dots, k\}$ such that there is an ordered sequence

$$R_{i_1}(\tilde{A}) \succ R_{i_2}(\tilde{A}) \succ \dots \succ R_{i_k}(\tilde{A})$$

for these bidding $R_1(\tilde{A}), R_2(\tilde{A}), \dots, R_k(\tilde{A})$ of bidders R_1, R_2, \dots, R_k . Here, these bidders R_{i_1}, R_{i_2} and R_{i_3} are *pre-successful bidders* in succession determined by the bid evaluation committee in the laws and regulations in China.

Definition 2.2 *An ordered sequence for elements in the symmetry group S_n on $\{1, 2, \dots, m\}$ is said an alphabetical sequence if it is arranged by the following criteria:*

- (i) $(1, 0 \dots, 0) \succeq P$ for any permutation $P \in S_n$.
- (ii) if integers $s_1, s_2, \dots, s_h \in \{1, 2, \dots, m\}, 1 \leq h < m$ and permutations $(s_1, s_2, \dots, s_h, t, \dots), (s_1, s_2, \dots, s_h, l, \dots) \in S_n$, then

$$(s_1, s_2, \dots, s_h, t, \dots) \succ (s_1, s_2, \dots, s_h, l, \dots)$$

if and only if $t < l$. Let $\{x_{\sigma_i}\}_1^n$ be a sequence, where $\sigma_1 \succ \sigma_2 \succ \cdots \succ \sigma_n$ and $\sigma_i \in S_n$ for $1 \leq i \leq n$, then the sequence $\{x_{\sigma_i}\}_1^n$ is said an alphabetical sequence.

Now if $x_\sigma \succ x_\tau$, x_σ is preferable than x_τ in order. If $x_\sigma \succeq x_\tau$, then x_σ is preferable or equal with x_τ in order. If $x_\sigma \succeq x_\tau$ and $x_\tau \succeq x_\sigma$, then x_σ is equal x_τ in order, denoted by $x_\sigma \approx x_\tau$.

We get the following result for an evaluation of a tendering.

Theorem 2.1 Let $O_1, O_2, O_3 \cdots$ be ordered sets. If $R_j(\tilde{A}) \in O_1 \times O_2 \times O_3 \times \cdots$ for any integer $j, 1 \leq j \leq k$, then there exists an arrangement i_1, i_2, \cdots, i_k for indexes $1, 2, \cdots, k$ such that

$$R_{i_1}(\tilde{A}) \succeq R_{i_2}(\tilde{A}) \succeq \cdots \succeq R_{i_k}(\tilde{A}).$$

Proof By the assumption, for any integer $j, 1 \leq j \leq k$,

$$R_j(\tilde{A}) \in O_1 \times O_2 \times O_3 \times \cdots.$$

Whence, $R_j(\tilde{A})$ can be represented by

$$R_j(\tilde{A}) = (x_{j1}, x_{j2}, x_{j3}, \cdots),$$

where $x_{jt} \in O_t, t \geq 1$. Define a set

$$S_t = \{x_{jt}; 1 \leq j \leq m\}.$$

Then the set $S_t \subseteq O_t$ is finite. Because the set O_t is an ordered set, so there exists an order for elements in S_t . Not loss of generality, assume the order is

$$x_{1t} \succeq x_{2t} \succeq \cdots \succeq x_{mt},$$

for elements in S_t . Then we can apply the alphabetical approach to $R_{i_1}(\tilde{A}), R_{i_2}(\tilde{A}), \cdots, R_{i_k}(\tilde{A})$ and get indexes i_1, i_2, \cdots, i_k such that

$$R_{i_1}(\tilde{A}) \succeq R_{i_2}(\tilde{A}) \succeq \cdots \succeq R_{i_k}(\tilde{A}). \quad \square$$

If we choose $O_i, i \geq 1$ to be an ordered function set in Theorem 2.1, particularly, let $O_1 = \{f\}, f : A_i \rightarrow R, 1 \leq i \leq m$ be a monotone function set and $O_t = \emptyset$ for $t \geq 2$, then we get the next result.

Theorem 2.2 *Let $R_j : A_i \rightarrow R, 1 \leq i \leq m, 1 \leq j \leq k$ be monotone functions. Then there exists an arrangement i_1, i_2, \dots, i_k for indexes $1, 2, \dots, k$ such that*

$$R_{i_1}(\tilde{A}) \succeq R_{i_2}(\tilde{A}) \succeq \dots \succeq R_{i_k}(\tilde{A}).$$

We also get the following consequence for evaluation numbers by Theorem 2.2.

Corollary 2.1 *If $R_j(A_i) \in [-\infty, +\infty] \times [-\infty, +\infty] \times [-\infty, +\infty] \times \dots$ for any integers $i, j, 1 \leq i \leq m, 1 \leq j \leq k$, then there exists an arrangement i_1, i_2, \dots, i_k for indexes $1, 2, \dots, k$ such that*

$$R_{i_1}(\tilde{A}) \succeq R_{i_2}(\tilde{A}) \succeq \dots \succeq R_{i_k}(\tilde{A}).$$

Notice that in the above ordered sequence, if we arrange $R_{i_s} \succ R_{i_l}$ or $R_{i_l} \succ R_{i_s}$ further in the case of $R_{i_s} \approx R_{i_l}, s \neq l$, then we can get an ordered sequence

$$R_{i_1}(\tilde{A}) \succ R_{i_2}(\tilde{A}) \succ \dots \succ R_{i_k}(\tilde{A}),$$

and the pre-successful bidders accordance with the laws and regulations in China.

§3. A mathematical analog for bids evaluation

For constructing an evaluation system of bids by the multi-space of tendering, the following two problems should be solved in the first.

Problem 1 *For any integers $i, j, 1 \leq i, j \leq m$, how to determine $R_j(A_i)$ on account of the responsiveness of a bidder R_j on indexes $a_{i1}, a_{i2}, \dots, a_{in_i}$?*

Problem 2 *For any integer $j, 1 \leq j \leq m$, how to determine $R_j(\tilde{A})$ on account of the vector $(R_j(A_1), R_j(A_2), \dots, R_j(A_m))^t$?*

Different approaches for solving Problems 1 and 2 enable us to get different mathematical analogs for bids evaluation.

3.1. An approach of multiple objectives decision

This approach is originated at the assumption that $R_j(A_1), R_j(A_2), \dots, R_j(A_m), 1 \leq j \leq m$ are independent and can not compare under a unified value unit. The objectives of tendering is multiple, not only in the price, but also in the equipments, experiences, achievements, staff and the programme, etc., which are also required by the 41th item in the *Tendering and Bidding Law of the People's Republic of China*.

According to Theorems 2.1 – 2.2 and their inference, we can establish a programming for arranging the order of each evaluation item $A_i, 1 \leq i \leq m$ and getting an ordered sequence of bids $R_1(\tilde{A}), R_2(\tilde{A}), \dots, R_k(\tilde{A})$ of a tendering $\tilde{A} = \bigcup_{i=1}^m A_i$, as follows:

STEP 1 *determine the order of the evaluation items A_1, A_2, \dots, A_m . For example, for $m = 5, A_1 \succ A_2 \approx A_3 \succ A_4 \approx A_5$ is an order of the evaluation items A_1, A_2, A_3, A_4, A_5 .*

STEP 2 *for two bids $R_{j_1}(A_i), R_{j_2}(A_i), j_1 \neq j_2, 1 \leq i \leq m$, determine the condition for $R_{j_1}(A_i) \approx R_{j_2}(A_i)$. For example, let A_1 be the bidding price. Then $R_{j_1}(A_1) \approx R_{j_2}(A_1)$ providing $|R_{j_1}(A) - R_{j_2}(A_1)| \leq 100$ (10 thousand yuan).*

STEP 3 *for any integer $i, 1 \leq i \leq m$, determine the order of $R_1(A_i), R_2(A_i), \dots, R_k(A_i)$. For example, arrange the order of bidding price from lower to higher and the bidding programming dependent on the evaluation committee.*

STEP 4 *alphabetically arrange $R_1(\tilde{A}), R_2(\tilde{A}), \dots, R_k(\tilde{A})$, which need an approach for arranging equal bids $R_{j_1}(\tilde{A}) \approx R_{j_2}(\tilde{A})$ in order. For example, arrange them by the ruler of lower price preferable and get an ordered sequence*

$$R_{i_1}(\tilde{A}) \succ R_{i_2}(\tilde{A}) \succ \dots \succ R_{i_k}(\tilde{A})$$

of these bids $R_1(\tilde{A}), R_2(\tilde{A}), \dots, R_k(\tilde{A})$.

Notice that we can also get an ordered sequence through by defining the weight functions

$$\omega(\tilde{A}) = H(\omega(A_1), \omega(A_2), \dots, \omega(A_m))$$

and

$$\omega(A_i) = F(\omega(a_{i1}), \omega(a_{i2}), \dots, \omega(a_{in_i})).$$

For the weight function in detail, see the next section.

Theorem 3.1 *The ordered sequence of bids of a tendering \tilde{A} can be gotten by the above programming.*

Proof Assume there are k bidders in this tendering. Then we can alphabetically arrange these bids $R_{i_1}(\tilde{A}), R_{i_2}(\tilde{A}), \dots, R_{i_k}(\tilde{A})$ and get

$$R_{i_1}(\tilde{A}) \succeq R_{i_2}(\tilde{A}) \succeq \dots \succeq R_{i_k}(\tilde{A}).$$

Now applying the arranging approach in the case of $R_{j_1}(\tilde{A}) \approx R_{j_2}(\tilde{A})$, we finally obtain an ordered sequence

$$R_{i_1}(\tilde{A}) \succ R_{i_2}(\tilde{A}) \succ \dots \succ R_{i_k}(\tilde{A}). \quad \spadesuit$$

Example 3.1 *There are 3 evaluation items in a building construction tendering \tilde{A} with A_1 =price, A_2 =programming and A_3 =similar achievements in nearly 3 years. The order of the evaluation items is $A_1 \succ A_3 \succ A_2$ and $R_{j_1}(A_i) \approx R_{j_2}(A_i), 1 \leq i \leq 3$ providing $|R_{j_1}(A_1) - R_{j_2}(A_1)| \leq 150$, $R_{j_1}(A_2)$ and $R_{j_2}(A_2)$ are in the same rank or the difference of architectural area between $R_{j_1}(A_3)$ and $R_{j_2}(A_3)$ is not more than $40000m^2$. For determining the order of bids for each evaluation item, it applies the rulers that from the lower to the higher for the price, from higher rank to a lower rank for the programming by the bid evaluation committee and from great to small amount for the similar achievements in nearly 3 years and arrange $R_{j_1}(\tilde{A}), R_{j_2}(\tilde{A}), 1 \leq j_1, j_2 \leq k$ =bidders by the ruler of lower price first for two equal bids in order $R_{j_1}(\tilde{A}) \approx R_{j_2}(\tilde{A})$.*

There were 4 bidders R_1, R_2, R_3, R_4 in this tendering. Their bidding prices are in table 1.

bidder	R_1	R_2	R_3	R_4
A_1	3526	3166	3280	3486

table 1

Applying the arrangement ruler for A_1 , the order for $R_2(A_1), R_3(A_1), R_4(A_1), R_1(A_1)$ is

$$R_2(A_1) \approx R_3(A_1) \succ R_4(A_1) \approx R_1(A_1).$$

The evaluation order for A_2 by the bid evaluation committee is $R_3(A_2) \approx R_2(A_2) \succ R_1(A_2) \succ R_4(A_2)$. They also found the bidding results for A_3 are in table 2.

bidder	R_1	R_2	R_3	R_4
$A_3(m^2)$	250806	210208	290108	300105

table 2

Whence the order of $R_4(A_3), R_3(A_3), R_1(A_3), R_2(A_3)$ is

$$R_4(A_3) \approx R_3(A_3) \succ R_1(A_3) \approx R_2(A_3).$$

Therefore, the ordered sequence for these bids $R_1(\tilde{A}), R_2(\tilde{A}), R_3(\tilde{A})$ and $R_4(\tilde{A})$ is

$$R_3(\tilde{A}) \succ R_2(\tilde{A}) \succ R_4(\tilde{A}) \succ R_1(\tilde{A}).$$

Let the order of evaluation items be $A_1 \succ A_2 \succ \dots \succ A_m$. Then we can also get the ordered sequence of a tendering by applying a graphic method. By the terminology in graph theory, to arrange these bids of a tendering is equivalent to find a directed path passing through all bidders R_1, R_2, \dots, R_k in a graph $G[\tilde{A}]$ defined in the next definition. Generally, the graphic method is more convenience in the case of less bidders, for instance 7 bidders for a building construction tendering in China.

Definition 3.1 Let R_1, R_2, \dots, R_k be all these k bidders in a tendering $\tilde{A} = \bigcup_{i=1}^m A_i$. Define a directed graph $G[\tilde{A}] = (V(G[\tilde{A}]), E(G[\tilde{A}]))$ as follows.

$V(G[\tilde{A}]) = \{R_1, R_2, \dots, R_k\} \times \{A_1, A_2, \dots, A_m\}$, $E(G[\tilde{A}]) = E_1 \cup E_2 \cup E_3$, where E_1 consists of all these directed edges $(R_{j_1}(A_i), R_{j_2}(A_i))$, $1 \leq i \leq m, 1 \leq j_1, j_2 \leq k$ and $R_{j_1}(A_i) \succ R_{j_2}(A_i)$ is an adjacent order. Notice that if $R_s(A_i) \approx R_l(A_i) \succ R_j(A_i)$, then there are $R_s(A_i) \succ R_j(A_i)$ and $R_l(A_i) \succ R_j(A_i)$ simultaneously. E_2 consists of edges $R_{j_1}(A_i)R_{j_2}(A_i)$, $1 \leq i \leq m, 1 \leq j_1, j_2 \leq k$, where $R_{j_1}(A_i) \approx R_{j_2}(A_i)$ and $E_3 = \{R_j(A_i)R_j(A_{i+1}) | 1 \leq i \leq m - 1, 1 \leq j \leq k\}$.

For example, the graph $G[\tilde{A}]$ for Example 3.1 is shown in Fig.2.

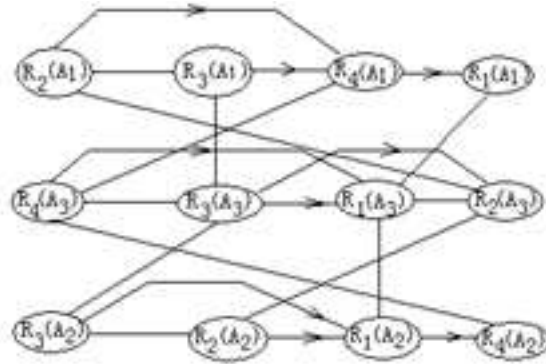

Fig.2

Now we need to find a directed path passing through R_1, R_2, R_3, R_4 with start vertex $R_2(A_1)$ or $R_3(A_1)$. By the ruler in an alphabetical order, we should travel starting from the vertex $R_3(A_1)$ passing through A_2, A_3 and then arriving at A_1 . Whence, we find a direct path correspondent with the ordered sequence

$$R_3(\tilde{A}) \succ R_2(\tilde{A}) \succ R_4(\tilde{A}) \succ R_1(\tilde{A}).$$

3.2. An approach of simply objective decision

This approach is established under the following considerations for Problems 1 and 2.

Consideration 1 *In these evaluation items A_1, A_2, \dots, A_m of a tendering \tilde{A} , seek the optimum of one evaluation item. For example, seek the lowest bidding price in a construction tendering for a simply building or seek the optimum of design scheme in a design project tendering, etc..*

Consideration 2 *The value of these evaluation items A_1, A_2, \dots, A_m is comparable which enables us to measure each of them by a unify unit and to construct various weighted functions on them. For example, the 100 marks and the lowest evaluated price method widely used in China are used under this consideration.*

3.2.1. The optimum of one objective

Assume the optimal objective being A_1 in a tendering $\tilde{A} = \bigcup_{i=1}^m A_i$. We need to determine the acceptable basic criterions for all other items A_2, A_3, \dots, A_k , then arrange $R_1(A_1), R_2(A_1), \dots, R_l(A_1)$ among these acceptable bids R_1, R_2, \dots, R_l for items A_2, A_3, \dots, A_k in $R_i, 1 \leq i \leq k$. For example, evaluating these items A_2, A_3, \dots, A_k

by qualification or by weighted function on A_2, A_3, \dots, A_k up to these criterions, then arrange these acceptable bids R_1, R_2, \dots, R_l under their response to A_1 and the order of $R_i(\tilde{A}), R_j(\tilde{A})$ if $R_i(A_1) \approx R_j(A_1)$. According to Theorem 3.1, we get the following result.

Theorem 3.2 *The approach of one optimal objective can get an ordered sequence of bids for a tendering \tilde{A} .*

Example 3.2 *The optimum of design scheme is the objective in a design project tendering \tilde{A} which is divided into 5 ranks A, B, C, D, E and other evaluation items such as human resources, design period and bidding price by a qualifiable approach if the bidding price is in the interval of the service fee norm of China. The final order of bids is determined by the order of design schemes with qualifiable human resources, design period and bidding price and applying the ruler of lower price first for two equal design scheme in order.*

There were 8 bidders in this tendering. Their bidding prices are in table 3.

<i>bidder</i>	R_1	R_2	R_3	R_4	R_5	R_6	R_7	R_8
<i>bidding price</i>	251	304	268	265	272	283	278	296

table 3

After evaluation for these human resources, design period and bidding price, 4 bidders are qualifiable unless the bidder R_5 in human resources. The evaluation result for bidding design schemes is in table 4.

<i>rank</i>	A	B	C	D	E
<i>design scheme</i>	R_3, R_6	R_1	R_2, R_8	R_7	R_4

table 4

Therefore, the ordered sequence for bids is

$$R_3(A) \succ \tilde{R}_6(\tilde{A}) \succ R_1(\tilde{A}) \succ R_8(\tilde{A}) \succ R_2(\tilde{A}) \succ R_7(\tilde{A}) \succ R_4(\tilde{A}).$$

Example 3.3 *The optimum objective in a tendering \tilde{A} for a construction of a dwelling house is the bidding price A_1 . All other evaluation items, such as qualifications, management persons and equipments is evaluated by a qualifiable approach.*

There were 7 bidders $R_i, 1 \leq i \leq 7$ in this tendering. The evaluation of price is by a weighted function approach, i.e., determine the standard price S first, then calculate the mark N of each bidder by the following formulae

$$S = \frac{(\sum_{i=1}^7 A_i - \max\{R_i(A_1)|1 \leq i \leq 7\} - \min\{R_i(A_1)|1 \leq i \leq 7\})}{5},$$

$$N_i = 100 - t \times \left| \frac{R_i(A_1) - S}{S} \right| \times 100, \quad 1 \leq i \leq 7,$$

where, if $R_i(A_1) - S > 0$ then $t = 6$ and if $R_i(A_1) - S < 0$ then $t = 3$.

After evaluation, all bidders are qualifiable in qualifications, management persons and equipments. Their bidding prices are in table 5.

bidder	R_1	R_2	R_3	R_4	R_5	R_6	R_7
A_1	3518	3448	3682	3652	3490	3731	3436

table 5

According to these formulae, we get that $S = 3558$ and the mark of each bidder as those shown in table 6.

bidder	R_1	R_2	R_3	R_4	R_5	R_6	R_7
mark	96.70	91.27	79.12	84.16	94.27	73.84	89.68

table 6

Therefore, the ordered sequence of bids is

$$R_1(\tilde{A}) \succ R_5(\tilde{A}) \succ R_2(\tilde{A}) \succ R_7(\tilde{A}) \succ R_4(\tilde{A}) \succ R_3(\tilde{A}) \succ R_6(\tilde{A}).$$

3.2.2. The pseudo-optimum of multiple objectives

This approach assumes that there is a unifying unit between these evaluation items A_1, A_2, \dots, A_m in an interval $[a, b]$. Whence it can be transformed into case 3.2.1 and sought the optimum of one objective. Not loss of generality, we assume the unifying unit is ϖ and

$$\varpi(A_i) = f_i(\varpi), \quad 1 \leq i \leq m,$$

where f_i denotes the functional relation of the metric $\varpi(A_i)$ with unit ϖ . Now the objective of tendering turns to a programming of one objective

$$\max_{\varpi} F(f_1(\varpi), f_2(\varpi), \dots, f_m(\varpi)) \text{ or } \min_{\varpi} F(f_1(\varpi), f_2(\varpi), \dots, f_m(\varpi)),$$

where F denotes the functional relation of the tendering \tilde{A} with these evaluation items A_1, A_2, \dots, A_m , which can be a weighted function, such as a linear function

$$F(f_1(\varpi), f_2(\varpi), \dots, f_m(\varpi)) = \sum_{i=1}^m f_i(\varpi)$$

or an ordered sequence. According to Theorem 3.2, we know the following result.

Theorem 3.3 *If the function F of a tendering \tilde{A} only has one maximum value in $[a, b]$, then there exists an ordered sequence for these bids $R_i(\tilde{A}), 1 \leq i \leq k$ after determined how to arrange $R_i(\tilde{A})$ and $R_j(\tilde{A})$ when $F(R_i(\tilde{A})) = F(R_j(\tilde{A})), i \neq j$.*

The 100 marks and the lowest evaluated price method widely used in China both are applications of this approach. In the 100 marks, the weight function is a linear function

$$F(f_1(\varpi), f_2(\varpi), \dots, f_m(\varpi)) = \sum_{i=1}^m f_i(\varpi),$$

with $0 \leq F(f_1(\varpi), f_2(\varpi), \dots, f_m(\varpi)) \leq 100, f_i \geq 0, 1 \leq i \leq m$. In the lowest evaluated price method, each difference of an evaluation item $A_i, 2 \leq i \leq m$ is changed to the bidding price $\varpi(A_1)$, i.e.,

$$f_i = (R(A_i) - S(A_i))\varpi(A_1), \quad 1 \leq i \leq m,$$

where $S(A_i)$ is the standard line for A_i , $\varpi(A_i)$ is one unit difference of A_i in terms of A_1 . The weighted function of the lowest evaluated price method is

$$F(\varpi(A_1), f_2(\varpi(A_1)), \dots, f_m(\varpi(A_1))) = (1 + \sum_{j=2}^m (R(A_j) - S(A_j)))\varpi(A_1).$$

For example, we can fix one unit difference of a technological parameter 15, i.e., $\varpi(A_1) = 15$ ten thousand dollars in terms of the bidding price.

§4. Weighted functions and their construction

We discuss weighted functions on the evaluation items or indexes in this section. First, we give a formal definition for weighted functions.

Definition 4.1 For a tendering $\tilde{A} = \bigcup_{i=1}^m A_i$, where $A_i = \{a_{i1}, a_{i2}, \dots, a_{in}\}$, $1 \leq i \leq m$ with k bidders R_1, R_2, \dots, R_k , if there is a continuous function $\omega : \tilde{A} \rightarrow [a, b] \subset (-\infty, +\infty)$ or $\omega : A_i \rightarrow [a, b] \subset (-\infty, +\infty)$, $1 \leq i \leq m$ such that for any integers $l, s, 1 \leq l, s \leq k$, $R_l(\omega(\tilde{A})) > R_s(\omega(\tilde{A}))$ or $R_l(\omega(\tilde{A})) = R_s(\omega(\tilde{A}))$ as $R_l(\tilde{A}) \succ R_s(\tilde{A})$ or $R_l(\tilde{A}) \approx R_s(\tilde{A})$ and $R_l(\omega(A_i)) > R_s(\omega(A_i))$ or $R_l(\omega(A_i)) = R_s(\omega(A_i))$ as $R_l(A_i) \succ R_s(A_i)$ or $R_l(A_i) \approx R_s(A_i)$, $1 \leq i \leq m$, then ω is called a weighted function for the tendering \tilde{A} or the evaluation items $A_i, 1 \leq i \leq m$.

According to the decision theory of multiple objectives([3]), the weighted function $\omega(A_i)$ must exists for any integer $i, 1 \leq i \leq m$. but generally, the weight function $\omega(\tilde{A})$ does not exist if the values of these evaluation items A_1, A_2, \dots, A_m can not compare. There are two choice for the weighted function $\omega(A_i)$.

Choice 1 the monotone functions in the interval $[a, b]$, such as the linear functions.

Choice 2 The continuous functions only with one maximum value in the interval $[a, b]$, such as $\omega(A_i) = -2x^2 + 6x + 12$ or

$$\omega(A_i) = \begin{cases} x, & \text{if } 0 \leq x \leq 2, \\ -x + 4, & \text{if } x \geq 4. \end{cases}$$

As examples of concrete weighted functions ω , we discuss the tendering of civil engineering constructions.

4.1. The weighted function for the bidding price

Let A_1 be the bidding price. We often encounter the following weighted function $\omega(A_1)$ in practice.

$$\omega(R_i(A_1)) = -\varsigma \times \frac{R_i(A_1) - S}{S} + \zeta$$

where,

$$S = \frac{R_1(A_1) + R_2(A_1) + \dots + R_k(A_1)}{k}$$

or

$$S = \begin{cases} \frac{R_1(A_1)+R_2(A_1)+\dots+R_k(A_1)-M-N}{k-2}, & k \geq 5, \\ \frac{R_1(A_1)+R_2(A_1)+\dots+R_k(A_1)}{k}, & 3 \leq k \leq 4 \end{cases}$$

or

$$S = T \times A\% + \frac{R_1(A_1) + R_2(A_1) + \dots + R_k(A_1)}{k} \times (1 - A\%).$$

Where $T, A\%, k, M$ and N are the pre-price of the tender, the percentage of T in S , the number of bidders and the maximum and minimum bidding price, respectively, $R_i(A_1), i = 1, 2, \dots, k$ denote the bidding prices and ς, ζ are both constants.

There is a postulate in these weighted functions, i.e., each bidding price is random and accord with the normal distribution. Then the best expected value of this civil engineering is the arithmetic mean of these bidding prices. However, each bidding price is not random in fact. It reflects the bidder's expected value and subjectivity in a tendering. We can not apply any definite mathematics to fix its real value. Therefore, this formula for a weighted function can be only seen as a game, not a scientific decision.

By the view of scientific decision, we can apply weighted functions according to the expected value and its cost in the market, such as

(1) *the linear function*

$$\omega(R_i(A_1)) = -p \times \frac{R_i(A_1) - N}{M - N} + q$$

in the interval $[N, M]$, where M, N are the maximum and minimum bidding prices p is the deduction constant and q is a constant such that $R_i(\omega(A_1)) \geq 0, 1 \leq i \leq k$. The objective of this approach is seek a lower bidding price.

(2) *non-linear functions in the interval $[N, M]$, such as*

$$\omega(R_i(A_1)) = -p \times \frac{R_i(A_1) - \frac{T + \sum_{j=1}^k R_j(A_1)}{k+1}}{+} q,$$

$$\omega(R_i(A_1)) = -p \times \frac{R_i(A_1) - \sqrt[k+1]{R_1(A_1)R_2(A_1) \cdots R_k(A_1)T}}{\sqrt[k+1]{R_1(A_1)R_2(A_1) \cdots R_k(A_1)T}} + q$$

$$\omega(R_i(A_2)) = \omega(R_i(a_{21})) + \omega(R_i(a_{22})) + \cdots + \omega(R_i(a_{2n_2})).$$

For example, there are 4 evaluation indexes for the programming, and each with A, B, C, D ranks in a tendering. The correspondent mark for each rank is in table 7.

index	a_{21}	a_{22}	a_{23}	a_{24}
A	4	2	2	1
B	3	1.5	1.5	0.8
C	2	1	1	0.5
D	1	0.5	0.5	0.3

table 7

If the evaluation results for a bidding programming $R_i, 1 \leq i \leq 4$ are $\omega(R_i(a_{21})) = A, \omega(R_i(a_{22})) = B, \omega(R_i(a_{23})) = B$ and $\omega(R_i(a_{24})) = A$, then the mark of this programming is

$$\begin{aligned} R_i(\omega(A_2)) &= R_i(\omega(a_{21})) + R_i(\omega(a_{22})) + R_i(\omega(a_{23})) + R_i(\omega(a_{24})) \\ &= 4 + 3 + 1.5 + 1 = 9.5. \end{aligned}$$

By the approach in Section 3, we can alphabetically or graphically arrange the order of these programming if we can determine the rank of each programming. Certainly, we need the order of these indexes for a programming first. The index order for programming is different for different constructions tendering.

§5. Further discussions

5.1 Let $\tilde{A} = \bigcup_{i=1}^m A_i$ be a Smarandache multi-space with an operation set $O(\tilde{A}) = \{\circ_i; 1 \leq i \leq m\}$. If there is a mapping Θ on \tilde{A} such that $\Theta(\tilde{A})$ is also a Smarandache multi-space, then (\tilde{A}, Θ) is called a *pseudo-multi-space*. Today, nearly all geometries, such as the *Riemann* geometry, *Finsler* geometry and these pseudo-manifold geometries are particular cases of pseudo-multi-geometries.

For applying Smarandache multi-spaces to an evaluation system, choose $\Theta(\tilde{A})$ being an order set. Then Theorem 3.1 only asserts that any subset of $\Theta(\tilde{A})$ is an

order set, which enables us to find the ordered sequence for all bids in a tendering. Particularly, if $\Theta(\tilde{A})$ is continuous and $\Theta(\tilde{A}) \subseteq [-\infty, +\infty]$, then Θ is a weighted function on \tilde{A} widely applied in the evaluation of bids in China. By a mathematical view, many problems on (\tilde{A}, Θ) is valuable to research. Some open problems are presented in the following.

Problem 5.1 Characterize these pseudo-multi-spaces (\tilde{A}, Θ) , particularly, for these cases of $\Theta(\tilde{A}) = \bigcup_{i=1}^n [a_i, b_i]$, $\Theta(\tilde{A}) = \bigcup_{i=1}^n (G_i, \circ_i)$ and $\Theta(\tilde{A}) = \bigcup_{i=1}^n (R; +_i, \circ_i)$ with (G_i, \circ_i) and $(R; +_i, \circ_i)$ being a finite group or a ring for $1 \leq i \leq n$.

Problem 5.2 Let $\Theta(\tilde{A})$ be a group, a ring or a filed. Can we find an ordered sequence for a finite subset of \tilde{A} ?

Problem 5.3 Let $\Theta(\tilde{A})$ be n lines or n planes in an Euclid space \mathbf{R}^n . Characterize these pseudo-multi-spaces (\tilde{A}, Θ) . Can we find an arrangement for a finite subset of \tilde{A} ?

5.2 The evaluation approach in this paper can be also applied to evaluate any multiple objectives, such as the evaluation of a scientific project, a personal management system, an investment of a project, \dots , etc..

References

- [1] G.Chartrand and L.Lesniak, *Graphs & Digraphs*, Wadsworth, Inc., California, 1986.
- [2] T.Chen, *Decision Approaches in Multiple Objectives*(in Chinese), in *The Handbook of Modern Engineering Mathematics*, Vol.IV, Part 77,1357-1410. Central China Engineering College Press, 1987.
- [3] P.C.Fishburn, *Utility Theory for Decision Making*, New York, Wiley, 1970.
- [4] D.L.Lu, X.S.Zhang and Y.Y.Mi, An offer model for civil engineering construction, *Chinese OR Transaction*, Vol.5, No.4(2001)41-52.
- [5] L.F.Mao, *On Automorphisms groups of Maps, Surfaces and Smarandache geometries*, *Sientia Magna*, Vol.1(2005), No.2, 55-73.
- [6] L.F.Mao, *Automorphism Groups of Maps, Surfaces and Smarandache Geometries*, American Research Press, 2005.
- [7] L.F.Mao, *Smarandache multi-space theory*, Hexis, Phoenix, AZ, 2006.
- [8] L.F.Mao, *Chinese Construction Project Bidding Technique & Cases Analyzing—*

Smarandache Multi-Space Model of Bidding, Xiquan Publishing House (Chinese Branch), America, 2006.

- [9] F.Smarandache, Mixed noneuclidean geometries, *eprint arXiv: math/0010119*, 10/2000.
- [10] F.Smarandache, *A Unifying Field in Logics. Neutrosophy: Neutrosophic Probability, Set, and Logic*, American research Press, Rehoboth, 1999.
- [11] F.Smarandache, Neutrosophy, a new Branch of Philosophy, *Multi-Valued Logic*, Vol.8, No.3(2002)(special issue on Neutrosophy and Neutrosophic Logic), 297-384.
- [12] F.Smarandache, A Unifying Field in Logic: Neutrosophic Field, *Multi-Valued Logic*, Vol.8, No.3(2002)(special issue on Neutrosophy and Neutrosophic Logic), 385-438.

21math-001-006

招标评价体系的数学模型及求解分析*

毛林繁

中国科学院数学与系统科学研究院, 北京 100080

maolinfan@163.com

摘要. 招标是招标人发出邀约邀请, 投标人依据邀请递交邀约, 招标人发出中标通知书承诺邀约的一种合同谈判过程。招标作为采购的一种方式, 世界性金融组织和工程咨询协会均在其采购指南中对招标采购的行为准则进行了详细规定, 中国更是将这种市场采购行为上升到了法律, 形成了庞大的中国招标投标法律法规体系。虽如此, 对招标投标模型及其评价体系的研究一直处在初级阶段, 缺乏统一的理论体系。本文的主要目的在于依据作者新近在美国出版的两本专著 [7][8], 建立招标评价体系的Smarandache 重空间模型, 并采用多目标决策方法和价值工程理论对其进行求解分析, 建立起这种可应用于招标投标实践的数学理论。文章最后对中国内地目前通行的评价体系进行了讨论, 指出了其存在的问题及解决途径。

A Mathematical Model for Chinese Bids Evaluation with Its Solution Analyzing

Abstract. A tendering is a negotiating process for a contract through by a tenderer issuing an invitation, bidders submitting bidding documents and the tenderer accepting a bidding by sending out a notification of award. As a useful way of purchasing, there are many norms and rulers for it in the purchasing guides of the World Bank, the Asian Development Bank, ..., also in contract conditions of various consultant associations.

¹e-print: 中国科技论文在线: 200607-112.

In China, there is a law and regulation system for tendering and bidding. However, few works on the mathematical model of a tendering and its evaluation can be found in publication. The main purpose of this paper is to construct a Smarandache multi-space model for a tendering, establish an evaluation system for bidding based on those ideas in the references [7] and [8] and analyze its solution by applying the decision approach for multiple objectives and value engineering. The final section discusses some questions for the bids evaluation system already existed in China today. Some suggestions for solving these questions are presented in this section.

关键词: 招标, 投标, 评标, *Smarandache*重空间, 中标条件, 多目标决策, 单目标决策, 伪综合评价。

分类号 AMS(2000): 90B50,90C35,90C90

1. 引言

招标是市场经济中的一种行之有效的采购方式。依据《中华人民共和国合同法》(第九届全国人民代表大会, 1999年3月15日)中的规定, 招标实际上是招标人通过招标公告或投标邀请书发出单方邀约邀请, 投标人依据邀请递交投标函邀约, 招标人发出中标通知书承诺邀约的一种民事活动。活动过程本身构成了一种合同谈判的过程。通过这种方式确定的合同, 其合同成立与合同生效有一定的时间差, 即招标人向中标人发出中标通知书意味着合同成立, 但只有双方依法签订了书面合同后才表明合同生效。

《中华人民共和国招标投标法》(第九届全国人民代表大会, 1999年8月30日)中规定了招标投标程序及参与招标投标活动的招标人、投标人、评标委员会和招标投标行政监督管理部门各方的责任、权利与义务, 其中招标人是提出依法招标项目, 制定招标规则的一方; 投标人则是依据招标规则响应投标的一方, 其与招标规则的符合性则由依法组建的第三方评标委员会来评判。虽然法律规定评标委员会由招标人依法组建, 但其行为不依赖于招标人, 同时规定任何单位和个人不得非法干预、影响评标的过程和结果, 是相对独立的第三方。上述三方在招标投标活动中的行为应符合法律规定, 接受有关行政监督管理部门依法实施的监督。

中国招标投标法律体系规定的招标投标可以采用空间正四面体, 如图1对各方行为进行形象描述。



图 1. 招标活动各方的关系

《中华人民共和国招标投标法》第四十一条规定了中标人应当符合下述条件之一：

- (1) 能够最大限度地满足招标文件中规定的各项综合评价标准；
- (2) 能够满足招标文件的实质性要求，并且经评审的投标价格最低；但是投标价格低于成本价的除外。

这里的条件 (1) 和 (2) 实际上就是常见到的“综合评估法”和“经评审的最低评标价法”。这一条同时也预示着在中国国内实行的招标体制是一种多目标体制，不单纯考虑价格因素，同时还考虑技术装备、实力、人员状况、和方案的优劣等因素。然而，目前常见到的评标方法则将其简单化，不去考虑多目标决策的科学方法和应该考虑的问题，如综合评估法实际上让百分制打分取代，而经评审的最低评标价法则为简单的最低投标价法取代。且不论这种多目标体制下不同目标之间是否存在价值可比性，单就目前投标人和评标专家专业素质在投标或评判中就存在许多问题，直接造成项目中标成本失真或中标结果失真。那么，如何在法律界定的条件下建立一种科学的评价体系就成了当务之急。本文的主要目的在于依据作者新近在美国出版的专著 [7] 中 Smardanche 重空间理论和 [8] 中的招标数学模型，采用多目标决策和价值工程理论，建立一种统一的招标评价体系的数学模型，并进行理论分析和实践对比，以期寻求一种科学的招标评价体系，进而满足实际招标及管理的需要。

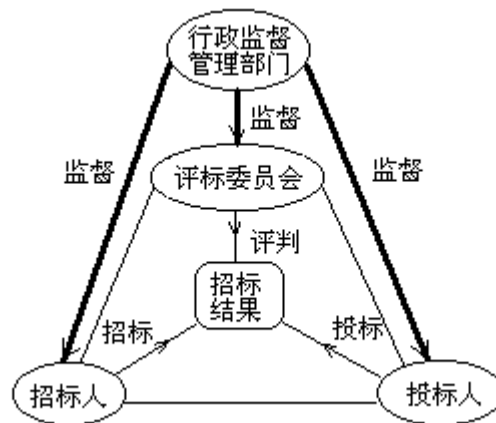
本文中有关重空间的术语见文献 [7]，其它规划、决策和图论方面的术语见 [1]-[3] 和 [6]，中国招标投标法律法规方面的术语见文献 [8]。

2. 招标投标的数学模型

依据其提出的“反思维”、“悖论”思想，Smardanche 于 1969 年提出了重空间

的概念 ([9]-[12]), 这一概念包括代数重空间和重度量空间两种, 后者包括目前国际上广为传播的 Smarandache 几何 ([5]-[6]), 可以直接应用于广义相对论和宇宙物理学 ([7])。而作为重度量空间的一个实际应用, 它又恰好可用来构造招标评价体系的数学模型。

定义 2.1 一个 m -重空间 Σ , 定义为 m 个集合 A_1, A_2, \dots, A_m 的并, 这里 $1 \leq m < +\infty$,

$$\Sigma = \bigcup_{i=1}^m A_i$$

且每个集合 A_i 上均定义了一种运算或规则 \circ_i 使得 (A_i, \circ_i) 为一个代数体系, 这里 n 为正整数, $1 \leq i \leq m$ 。

注意, 若 $i \neq j, 1 \leq i, j \leq m$, 这里并不一定要求 $A_i \cap A_j = \emptyset$, 与招标项目的特点正好对应。据此可以对一个招标项目构造 Smarandache 重空间模型如下。

假定一个招标项目 \tilde{A} 中设置了 m 个评价项目 A_1, A_2, \dots, A_m , 每个评价项目 A_i 中又设置了 n_i 个评审指标 $a_{i1}, a_{i2}, \dots, a_{in_i}$, 这里, $1 \leq i \leq m$ 。采用数学表述, 这个招标项目为

$$\tilde{A} = \bigcup_{i=1}^m A_i,$$

其中, 对任意整数 $i, 1 \leq i \leq m$,

$$(A_i, \circ_i) = \{a_{i1}, a_{i2}, \dots, a_{in_i} | \circ_i\}$$

为一种代数体系。注意, 除 $A_i \subseteq \tilde{A}$ 和 $a_{ij} \in A_i$ 外, 我们并没有规定出招标项目 \tilde{A} 以及评标指标 a_{ij} 与 $A_i, 1 \leq i \leq m$ 的关系。

现在假定该项目有 $k, k \geq 3$ 个投标人 R_1, R_2, \dots, R_k 参加了投标, 投标人 $R_j, 1 \leq j \leq k$ 的投标情况是

$$R_j(\tilde{A}) = R_j \begin{pmatrix} A_1 \\ A_2 \\ \dots \\ A_m \end{pmatrix} = \begin{pmatrix} R_j(A_1) \\ R_j(A_2) \\ \dots \\ R_j(A_m) \end{pmatrix}$$

《中华人民共和国招标投标法》及其相关法规规定的确定中标人方法实质上需要依据投标人 R_1, R_2, \dots, R_k 的投标 $R_1(\tilde{A}), R_2(\tilde{A}), \dots, R_k(\tilde{A})$ 最终确定出角标 i_1, i_2, \dots, i_k , 这里 $\{i_1, i_2, \dots, i_k\} = \{1, 2, \dots, k\}$, 使得其投标存在排序

$$R_{i_1}(\tilde{A}) \succ R_{i_2}(\tilde{A}) \succ \dots \succ R_{i_k}(\tilde{A}),$$

而 R_{i_1}, R_{i_2} 和 R_{i_3} 就是中国法律法规确定的依次推荐的中标候选人。

定义 2.2 整数集 $\{1, 2, \dots, m\}$ 上的全体置换 S_n 依据以下原则进行的排序称为字典排序:

- (i) 对任意置换 $P \in S_n$, $(1, 0 \dots, 0) \succeq P$;
- (ii) 若整数 $s_1, s_2, \dots, s_h \in \{1, 2, \dots, m\}, 1 \leq h \leq m$, 置换 $(s_1, s_2, \dots, s_h, t, \dots)$, $(s_1, s_2, \dots, s_h, l, \dots) \in S_n$, 则

$$(s_1, s_2, \dots, s_h, t, \dots) \succ (s_1, s_2, \dots, s_h, l, \dots)$$

当且仅当 $t < l$ 。若 $\{x_{\sigma_i}\}_1^n$ 是一个序列, 这里 $\sigma_1 \succ \sigma_2 \succ \dots \succ \sigma_n$ 且 $\sigma_i \in S_n$, 则称序列 $\{x_{\sigma_i}\}_1^n$ 为一个字典排序序列。

若 $x_\sigma \succ x_\tau$, 则称 x_σ 序优于 x_τ ; 若 $x_\sigma \succeq x_\tau$, 则称 x_σ 序不劣于 x_τ 。又若 $x_\sigma \succeq x_\tau$ 且 $x_\tau \succeq x_\sigma$, 我们称 x_σ 与 x_τ 同序。

我们得到下面这个关于招标结果排序的一般性结果。

定理 2.1 设集合 $O_1, O_2, O_3 \dots$ 为全序集, 若对任意整数 $j, 1 \leq j \leq k$, $R_j(\tilde{A}) \in O_1 \times O_2 \times O_3 \times \dots$, 则存在角标 $1, 2, \dots, k$ 的一种排序方法 i_1, i_2, \dots, i_k 使得

$$R_{i_1}(\tilde{A}) \succeq R_{i_2}(\tilde{A}) \succeq \dots \succeq R_{i_k}(\tilde{A}).$$

证明 依据假设, 对任意整数 $j, 1 \leq j \leq k$,

$$R_j(\tilde{A}) \in O_1 \times O_2 \times O_3 \times \dots,$$

故 $R_j(\tilde{A})$ 可以表示成

$$R_j(\tilde{A}) = (x_{j1}, x_{j2}, x_{j3}, \dots),$$

这里 $x_{jt} \in O_t, t \geq 1$ 。定义集合

$$S_t = \{x_{jt}; 1 \leq j \leq m\},$$

则有 $S_t \subseteq O_t$ 为有限集合。因为 O_t 为全序集，故 S_t 中的元存在排序，不失普遍性设其为

$$x_{1t} \succeq x_{2t} \succeq \cdots \succeq x_{mt},$$

则可以采用字典排序的方法对 $R_{i_1}(\tilde{A}), R_{i_2}(\tilde{A}), \dots, R_{i_k}(\tilde{A})$ 进行排序，最后得到角标 i_1, i_2, \dots, i_k ，使得

$$R_{i_1}(\tilde{A}) \succeq R_{i_2}(\tilde{A}) \succeq \cdots \succeq R_{i_k}(\tilde{A}). \quad \square$$

若取定理 2.1 中 $O_i, i \geq 1$ 为具有全序的函数集合，特别地， $O_1 = \{f\}, f: A_i \rightarrow R, 1 \leq i \leq m$ 为单调函数，且若 $t \geq 2, O_t = \emptyset$ ，则由定理 2.1 知

定理 2.2 设 $R_j: A_i \rightarrow R, 1 \leq i \leq m, 1 \leq j \leq k$ 为单调函数，则存在角标 $1, 2, \dots, k$ 的一种排序方法 i_1, i_2, \dots, i_k 使得

$$R_{i_1}(\tilde{A}) \succeq R_{i_2}(\tilde{A}) \succeq \cdots \succeq R_{i_k}(\tilde{A}).$$

特别地，定理 2.2 有如下推论。

推论 2.1 若对任意整数 $i, j, 1 \leq i \leq m, 1 \leq j \leq k$ ，有 $R_j(A_i) \in R \times R \times R \times \cdots$ ，则存在角标 $1, 2, \dots, k$ 的一种排序方法 i_1, i_2, \dots, i_k 使得

$$R_{i_1}(\tilde{A}) \succeq R_{i_2}(\tilde{A}) \succeq \cdots \succeq R_{i_k}(\tilde{A}).$$

注意在上述排序中，若依据实际情况进一步约定 $R_{i_s} \approx R_{i_l}, s \neq l$ 时的排序方法，则我们就可以得到满足中国法律法规要求的排序

$$R_{i_1}(\tilde{A}) \succ R_{i_2}(\tilde{A}) \succ \cdots \succ R_{i_k}(\tilde{A}),$$

从而依法推荐出中标候选人。

3. 招标评价体系的数学模拟

在上一节招标投标数学模型基础上建立招标评价体系需要解决以下两个问题：

问题 1: 对任意整数 $i, j, 1 \leq i, j \leq m$, 怎样依据投标人 R_j 在指标 $a_{i1}, a_{i2}, \dots, a_{in_i}$ 中的投标确定 $R_j(A_i)$?

问题 2: 对任意整数 $j, 1 \leq j \leq m$, 怎样依据向量 $(R_j(A_1), R_j(A_2), \dots, R_j(A_m))^t$ 判断 $R_j(\tilde{A})$?

对以上两个问题的不同认识, 带来招标评价体系不同的数学模拟方法。

3.1. 多目标决策体系

这种体系的数学出发点是认为问题 2 中的 $R_j(A_1), R_j(A_2), \dots, R_j(A_m)$ 相互独立, 不能采用统一的价值工程进行对比。基于招标不单纯是要一个好的价格, 同时要求中标人有良好的技术素质、业绩和管理实力, 这也是《中华人民共和国招标投标法》第四十一条中标条件所追求的。

依据上一节定理 2.1–2.2 及其推论, 我们可以一般性地建立招标项目 $\tilde{A} = \bigcup_{i=1}^m A_i$ 的每个评价项目 $A_i, 1 \leq i \leq m$ 的数学排序方法, 进而决定全部投标 $R_1(\tilde{A}), R_2(\tilde{A}), \dots, R_k(\tilde{A})$ 的排序, 其确定步骤如下:

第 1 步: 确定评价项目 A_1, A_2, \dots, A_m 的排序结果, 例如 $m = 5$ 时, $A_1 \succ A_2 \approx A_3 \succ A_4 \approx A_5$ 就是评价项目 A_1, A_2, A_3, A_4, A_5 的一种排序结果。

第 2 步: 对两个不同的投标 $R_{j_1}(A_i), R_{j_2}(A_i), j_1 \neq j_2, 1 \leq i \leq m$, 确定 $R_{j_1}(A_i) \approx R_{j_2}(A_i)$ 的条件。设 A_1 代表投标报价, 例如规定如 $|R_{j_1}(A) - R_{j_2}(A)| \leq 100$ 万元人民币, 则 $R_{j_1}(A) \approx R_{j_2}(A)$ 。

第 3 步: 对任意整数 $i, 1 \leq i \leq m$, 确定 $R_1(A_i), R_2(A_i), \dots, R_k(A_i)$ 的排序结果。例如对技术标采用专家评议, 对投标报价采用由低到高确定排序等。

第 4 步: 按字典排序法确定 $R_1(\tilde{A}), R_2(\tilde{A}), \dots, R_k(\tilde{A})$ 的排序。注意须确定出现同序情况 $R_{j_1}(\tilde{A}) \approx R_{j_2}(\tilde{A})$ 时的排序方法, 例如依据“投标报价少者优先”的原则进行排序, 最后得到 $R_1(\tilde{A}), R_2(\tilde{A}), \dots, R_k(\tilde{A})$ 的严格意义上的排序结果

$$R_{i_1}(\tilde{A}) \succ R_{i_2}(\tilde{A}) \succ \dots \succ R_{i_k}(\tilde{A}).$$

注意, 以上程序中均可以采用定义权函数 $\omega(\tilde{A}) = H(\omega(A_1), \omega(A_2), \dots, \omega(A_m))$ 和 $\omega(A_i) = F(\omega(a_{i1}), \omega(a_{i2}), \dots, \omega(a_{in_i}))$ 的方法来决定整体或分项排序。关于权函数的构造详见下一节。

定理 3.1 对于一个招标项目 \tilde{A} , 上述程序可以得到投标人的严格排序。

证明 假设有 k 各投标人参加投标, 则由字典排序法我们得到排序

$$R_{i_1}(\tilde{A}) \succeq R_{i_2}(\tilde{A}) \succeq \dots \succeq R_{i_k}(\tilde{A}).$$

再利用出现同序情况 $R_{j_1}(\tilde{A}) \approx R_{j_2}(\tilde{A})$ 时的排序方法, 我们最终得到严格排序

$$R_{i_1}(\tilde{A}) \succ R_{i_2}(\tilde{A}) \succ \dots \succ R_{i_k}(\tilde{A}). \quad \square$$

例 3.1 某个工程施工招标项目确定了 3 个评价项目, 依次为 $A_1 =$ 投标报价; $A_2 =$ 技术方案; $A_3 =$ 投标人近三年类似项目业绩, 其序关系为 $A_1 \succ A_3 \succ A_2$. 规定当 $|R_{j_1}(A_1) - R_{j_2}(A_1)| \leq 150$, $R_{j_1}(A_2)$ 与 $R_{j_2}(A_2)$ 档次相同和 $R_{j_1}(A_3)$ 与 $R_{j_2}(A_3)$ 的面积数差不大于 $40000m^2$ 时 $R_{j_1}(A_i) \approx R_{j_2}(A_i), 1 \leq i \leq 3$, 同时还规定投标报价排序由低到高, 技术方案排序由评标专家依据档次确定和近三年类似项目业绩以面积数多少进行排序, 以及同序投标最终排序以“价低优先”的原则进行排序。

该项目共有 4 个投标人 R_1, R_2, R_3, R_4 参加了投标, 其投标报价如下表 1.

投标人	R_1	R_2	R_3	R_4
A_1 (万元)	3526	3166	3280	3486

表 1. 投标报价表

这样, 依据上面制定的规则, 对 A_1 投标结果的排序为

$$R_2(A_1) \approx R_3(A_1) \succ R_4(A_1) \approx R_1(A_1).$$

评标委员会对 A_2 的评审结果为 $R_3(A_2) \approx R_2(A_2) \succ R_1(A_2) \succ R_4(A_2)$, 同时发现其对评审项目 A_3 的投标结果如下表 2.

投标人	R_1	R_2	R_3	R_4
$A_3(m^2)$	250806	210208	290108	300105

表 2. 近三年类似项目的面积数

故其排序结果为

$$R_4(A_3) \approx R_3(A_3) \succ R_1(A_3) \approx R_2(A_3).$$

这样, 依据字典排序的原则最后排序结果为

$$R_3(\tilde{A}) \succ R_2(\tilde{A}) \succ R_4(\tilde{A}) \succ R_1(\tilde{A}).$$

假设评价项目的序关系为 $A_1 \succ A_2 \succ \cdots \succ A_m$, 则这种多目标评价体系还可以采用图上作业法确定排序。采用图论中的术语, 确定最终排序的实质等同于在如下定义的图 $G[\tilde{A}]$ 中确定一条通过所有投标人 R_1, R_2, \cdots, R_k 的有向路, 而这对于投标人人数不多的情形是十分便利的。

定义 3.1 对一个有 k 个投标人 R_1, R_2, \cdots, R_k 参加投标的招标项目 $\tilde{A} = \bigcup_{i=1}^m A_i$, 定义一个图 $G[\tilde{A}]$ 如下:

$$V(G[\tilde{A}]) = \{R_1, R_2, \cdots, R_k\} \times \{A_1, A_2, \cdots, A_m\},$$

$$E(G[\tilde{A}]) = E_1 \cup E_2 \cup E_3,$$

其中 E_1 由所有有向边 $(R_{j_1}(A_i), R_{j_2}(A_i))$ 构成, 这里 $1 \leq i \leq m, 1 \leq j_1, j_2 \leq k$ 且 $R_{j_1}(A_i) \succ R_{j_2}(A_i)$ 为相邻序, 注意若 $R_s(A_i) \approx R_l(A_i) \succ R_j(A_i)$, 则同时 $R_s(A_i) \succ R_j(A_i)$ 和 $R_l(A_i) \succ R_j(A_i)$; E_2, E_3 均为无向边, 其中 E_2 由边 $R_{j_1}(A_i)R_{j_2}(A_i), 1 \leq i \leq m, 1 \leq j_1, j_2 \leq k$ 构成, 这里 $R_{j_1}(A_i) \approx R_{j_2}(A_i)$; $E_3 = \{R_j(A_i)R_j(A_{i+1}) | 1 \leq i \leq m-1, 1 \leq j \leq k\}$ 。

例如, 上面例 3.1 对应的有向图为



图 2. 例 3.1 对应的有向图

现在, 我们需要在图 2 中确定一条由 $R_2(A_1)$ 或 $R_3(A_1)$ 为起点, 经过所有投标人的有向路。依据字典排序, 我们应由 $R_3(A_1)$ 出发, 经过 A_2, A_3 , 最后到达 A_1 。这样就得到序关系 $R_3(\tilde{A}) \succ R_2(\tilde{A}) \succ R_4(\tilde{A}) \succ R_1(\tilde{A})$ 。

3.2. 单目标决策体系

单目标决策体系基于对问题 1 和 2 的以下两种认识:

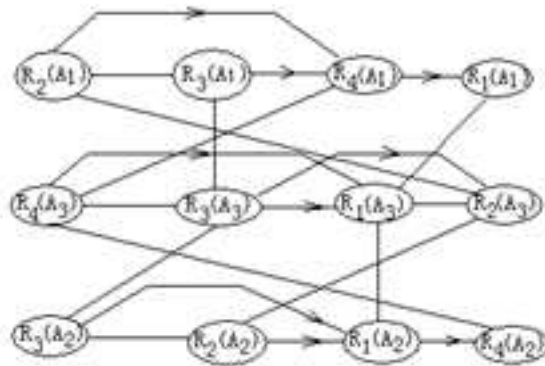
第 1 种: 在招标评价项目 A_1, A_2, \dots, A_m 中, 追求某一个评价项目的最优化。例如在一些民用建筑施工招标时, 追求报价最优; 而在一些设计招标中, 追求设计方案最优等。

第 2 种: 招标评价项目 A_1, A_2, \dots, A_m 具有价值可比性, 从而可以采用统一的度量对所有评价项目进行量化, 进而设置各种权函数对其进行量化比较而获得综合评价最优的目标。例如现在中国国内招标评价体系中常用的百分制打分和经评审的最低评标价法等。

3.2.1. 单目标最优化

这种方法以追求的单一评价项目最优, 兼顾其他评价项目为目标。假设招标项目 $\tilde{A} = \bigcup_{i=1}^m A_i$ 所追求的最优评价项目为 A_1 , 则需要对其他评价项目 A_2, A_3, \dots, A_k 设置出最低的可接受基准, 然后在对 A_2, A_3, \dots, A_k 可接受的投标, 设为 R_1, R_2, \dots, R_l 中对 $R_1(A_1), R_2(A_1), \dots, R_l(A_1)$ 进行排序, 进而决定推荐的中标候选人名单, 例如对评价项目 A_2, A_3, \dots, A_k 采用合格制评审或采用权函数的方法对 A_2, A_3, \dots, A_k 进行打分, 设置合格基准线, 然后依据合格的投标 R_1, R_2, \dots, R_l 对评价项目 A_1 的投标情况进行排序, 并制定出 $R_i(A_1) \approx R_j(A_1)$ 时 $R_i(\tilde{A})$ 与 $R_j(\tilde{A})$ 的排序方法。依据定理 3.1 我们得到以下结果。

定理 3.2 对于一个招标项目 \tilde{A} , 单目标最优可以得到投标结果的严格排序。

例 3.2 某工程设计方案招标项目 \tilde{A} 以追求设计方案最优为目标, 共分为 A, B, C, D, E 计 5 个档次。规定了人员配备、设计周期满足一定的条件、投标报价位于国家规定的取费标准允许的幅度内为合格, 并规定当设计方案评价档次相同时按“价低优先”的原则进行排序。该项目共有 8 个投标人参加投标, 其报价如下表 3。

投标人	R_1	R_2	R_3	R_4	R_5	R_6	R_7	R_8
投标报价 (万元)	251	304	268	265	272	283	278	296

表 3. 投标报价表

经过评审, 除投标人 R_5 配备的人员不符合招标要求外, 其他投标人的报价、设计周期和人员配备均符合要求。对投标人设计方案的评审结果如下表 4。

档次	A	B	C	D	E
投标方案档次	R_3, R_6	R_1	R_2, R_8	R_7	R_4

表 4. 设计方案评审结果

这样，投标人的最后排序结果为：

$$R_3(\tilde{A}) \succ \widetilde{R_6(\tilde{A})} \succ R_1(\tilde{A}) \succ R_8(\tilde{A}) \succ R_2(\tilde{A}) \succ R_7(\tilde{A}) \succ R_4(\tilde{A}).$$

例 3.3 某普通住宅工程施工招标项目 \tilde{A} 对投标人采取了资格、项目管理人员和技术装备审查通过制的基础上进行价格 A_1 评审的方法，共有 7 个投标人 $R_i, 1 \leq i \leq 7$ 参加了投标。其价格评审采用了权函数的方法，即首先确定评标基准价 S ，然后计算投标人得分 N ，这里

$$S = \frac{(\sum_{i=1}^7 A_i - \max\{R_i(A_1)|1 \leq i \leq 7\} - \min\{R_i(A_1)|1 \leq i \leq 7\})}{5},$$

$$N_i = 100 - t \times \left| \frac{R_i(A_1) - S}{S} \right| \times 100, \quad 1 \leq i \leq 7,$$

这里，若 $R_i(A_1) - S > 0$ 则 $t = 6$ ；若 $R_i(A_1) - S < 0$ 则 $t = 3$ 。同时规定当得分相同时，按“低价优先”原则排序。经过评审，7 个投标人的资格、项目管理人员和技术装备配备、施工组织设计均符合要求。投标人的报价如下表 5。

投标人	R_1	R_2	R_3	R_4	R_5	R_6	R_7
A_1 (万元)	3518	3448	3682	3652	3490	3731	3436

表 5. 投标报价表

依据以上计算方法，得到 $S = 3558$ 和投标人得分

投标人	N_1	N_2	N_3	N_4	N_5	N_6	N_7
得分	96.70	91.27	79.12	84.16	94.27	73.84	89.68

表 6. 报价得分表

故投标排序结果为：

$$R_1(\tilde{A}) \succ R_5(\tilde{A}) \succ R_2(\tilde{A}) \succ R_7(\tilde{A}) \succ R_4(\tilde{A}) \succ R_3(\tilde{A}) \succ R_6(\tilde{A}).$$

3.2.2. 伪综合评价最优

这种方法假设评价项目 A_1, A_2, \dots, A_m 在一个实数区间 $[a, b]$ 上存在统一的度量基准, 从而可以化为 3.2.1 的情形追求单目标最优。不失普遍性, 我们可以假设其统一度量为 ϖ , 且其相互间的关系为

$$\varpi(A_i) = f_i(\varpi), \quad 1 \leq i \leq m,$$

这里 f_i 表示函数关系, 则现在的招标就转化成了单目标规划

$$\max_{\varpi} F(f_1(\varpi), f_2(\varpi), \dots, f_m(\varpi))$$

或

$$\min_{\varpi} F(f_1(\varpi), f_2(\varpi), \dots, f_m(\varpi)),$$

这里 F 表示招标项目 \tilde{A} 与评价项目 A_1, A_2, \dots, A_m 间的关系, 可以是权函数, 如线性函数

$$F(f_1(\varpi), f_2(\varpi), \dots, f_m(\varpi)) = \sum_{i=1}^m f_i(\varpi)$$

或是某种序关系。利用定理 3.2, 我们得到下述结果。

定理 3.3 若函数 F 在区间 $[a, b]$ 上存在唯一的最大值, 经过进一步约定 $R_i(\tilde{A}) = R_j(\tilde{A}), i \neq j$ 时 $R_i(\tilde{A})$ 与 $R_j(\tilde{A})$ 的排序方法, 则伪综合评价得到投标人 $R_i, 1 \leq i \leq k$ 对招标项目 \tilde{A} 投标结果 $R_i(\tilde{A}), 1 \leq i \leq k$ 的严格序。

目前中国国内招标时采用的百分制打分和经评审的最低评标价法实际上均是这一评价体系的应用。在百分制打分中, 我们选用线性函数

$$F(f_1(\varpi), f_2(\varpi), \dots, f_m(\varpi)) = \sum_{i=1}^m f_i(\varpi),$$

且 $0 \leq F(f_1(\varpi), f_2(\varpi), \dots, f_m(\varpi)) \leq 100, f_i \geq 0, 1 \leq i \leq m$ 。而在经评审的最低评标价法中, 将其他评价项目 A_2, A_3, \dots, A_m 的投标偏差均折算成投标价格 A_1 , 即

$$f_i = (l(A_i) - l_0(A_i))\varpi(A_1), \quad 1 \leq i \leq m,$$

这里 l_0 是评价项目的评价基准点, $\varpi(A_1)$ 是单位偏差加价指标, 而采用的权函数为

$$F(\varpi(A_1), f_2(\varpi(A_1)), \dots, f_m(\varpi(A_1))) = (1 + \sum_{i=2}^m (l(A_i) - l_0(A_i)))\varpi(A_1).$$

例如规定当某个非关键性技术参数较需求的指标差一定值时, 增加其评标价格 10, 即 $\varpi(A_1) = 10$ 万元。

4. 权函数及其构造

这一节讨论定义于评价项目或评审指标上的权函数, 我们首先给出其数学定义。

定义 4.1 对于一个有 k 个投标人 R_1, R_2, \dots, R_k 参与投标的招标项目 $\tilde{A} = \bigcup_{i=1}^m A_i$ 或评价项目 $A_i = \{a_{i1}, a_{i2}, \dots, a_{in}\}, 1 \leq i \leq m$, 若存在一个连续函数 $\omega: \tilde{A} \rightarrow [a, b] \subset (-\infty, +\infty)$ 或 $\omega: A_i \rightarrow [a, b] \subset (-\infty, +\infty), 1 \leq i \leq m$, 使得任意整数 $l, s, 1 \leq l, s \leq k, R_l(\tilde{A}) \succ R_s(\tilde{A})$ 或 $R_l(\tilde{A}) \approx R_s(\tilde{A})$ 时有 $R_l(\omega(\tilde{A})) > R_s(\omega(\tilde{A}))$ 或 $R_l(\omega(\tilde{A})) = R_s(\omega(\tilde{A}))$, 或者 $R_l(A_i) \succ R_s(A_i)$ 或 $R_l(A_i) \approx R_s(A_i), 1 \leq i \leq m$ 时有 $R_l(\omega(A_i)) > R_s(\omega(A_i))$ 或 $R_l(\omega(A_i)) = R_s(\omega(A_i))$, 则称 ω 为招标项目 \tilde{A} 或评价项目 $A_i, 1 \leq i \leq m$ 上的一个权函数。

权函数是定量评审招标项目的基础。由于实际工作中投标人的数量是有限的, 依据多目标决策理论 ([3]), 对任意整数 $i, 1 \leq i \leq m$, 权函数 $\omega(A_i)$ 一定存在; 但一般地, 若评价项目 A_1, A_2, \dots, A_m 的价值不具有可比性, 则权函数 $\omega(\tilde{A})$ 不存在。关于 $\omega(A_i)$ 可以有以下两种选择方法:

- (1) 区间 $[a, b]$ 上的严格单调函数, 如线性函数等;
- (2) 区间 $[a, b]$ 上具有唯一最大值的连续函数, 如折线函数、二次函数等。

下面我们以工程招标为例, 对权函数 ω 进行进一步分析。

4.1. 报价权函数

设 A_1 为投标报价, 实际工作中经常遇到采用如下方法计算权函数 $\omega(A_1)$ 。首先计算评标基准价 S ,

$$S = \frac{R_1(A_1) + R_2(A_1) + \dots + R_k(A_1)}{k}$$

或

$$S = \begin{cases} \frac{R_1(A_1)+R_2(A_1)+\cdots+R_k(A_1)-M-N}{k-2}, & k \geq 5, \\ \frac{R_1(A_1)+R_2(A_1)+\cdots+R_k(A_1)}{k}, & 3 \leq k \leq 4 \end{cases}$$

或在有标底时采用

$$S = T \times A\% + \frac{R_1(A_1) + R_2(A_1) + \cdots + R_k(A_1)}{k} \times (1 - A\%).$$

这里, $R_i(A_1), i = 1, 2, \cdots, k$ 表示投标报价, k 为投标人的个数, M 、 N 分别为最高、最低投标报价, T 为标底价格, $A\%$ 为标底价格在评标基准价中所占权重。则权函数 $R_i(\omega(A_1)), 1 \leq i \leq k$ 的计算公式为

$$R_i(\omega(A_1)) = -\varsigma \times \frac{R_i(A_1) - S}{S} + \zeta$$

这里, ς 为扣分常数, 而 ζ 为一个使 $\omega(A_1) \geq 0$ 的常数。这一计算方法假设报价模型是正态分布, 如此采用数理统计的方法可以算出最接近实际工程价格的为投标人报价的算术平均数。但实际上, 招标中的投标报价不是一种随机事件, 其报价过程掺杂有投标人的主观愿望和期望值, 这种期望值在许多情形下不能采用定量方法来衡量。所以从科学决策角度讲, 这种方法不过是一种评判而非科学决策规则。

依据招标人的价格期望和市场行情, 可以采用如下权函数:

(1) 区间 $[N, M]$ 上的线性权函数

$$R_i(\omega(A_1)) = -p \times \frac{R_i(A_1) - N}{M - N} + q,$$

这里, p 为扣分常数, 而 q 为一个使 $R_i(\omega(A_1)) \geq 0, 1 \leq i \leq k$ 的常数。这种方法在对投标报价评审时追求价格最低。

(2) 区间 $[N, M]$ 上的非线性权函数, 如

$$R_i(\omega(A_1)) = -p \times \frac{R_i(A_1) - \frac{T + \sum_{j=1}^k R_j(A_1)}{k+1}}{+} q,$$

$$R_i(\omega(A_1)) = -p \times \frac{R_i(A_1) - \sqrt[k+1]{R_1(A_1)R_2(A_1)\cdots R_k(A_1)T}}{\sqrt[k+1]{R_1(A_1)R_2(A_1)\cdots R_k(A_1)T}} + q$$

或

$$R_i(\omega(A_1)) = -p \times \frac{R_i(A_1) - \sqrt{\frac{R_1^2(A_1) + R_2^2(A_1) + \dots + R_k^2(A_1) + T^2}{k+1}}}{\sqrt{\frac{R_1^2(A_1) + R_2^2(A_1) + \dots + R_k^2(A_1) + T^2}{k+1}}} + q$$

等, 这里 p, q 含义同上。

如果考虑衡量出报价的细微偏差, 则还可以求出报价的 $k+1$ 次多项式曲线, 即假定投标报价为 $k+1$ 次多项式

$$f(x) = a_{k+1}x^{k+1} + a_kx^k + \dots + a_1x + a_0$$

的值, 然后依据投标报价及标底价格由低到高的次序, 设为 $R_{j_1}(A_1) \succ R_{j_2}(A_1) \succ \dots \succ T \succ \dots \succ R_{j_k}(A_1)$, 依次对应 $k+2$ 个常数 $c_1 > c_2 > \dots > c_{k+1} > 0$, 例如 $k+1 > k > \dots > 1 > 0$, 解方程组

$$R_{j_1}(A_1) = a_{k+1}c_1^{k+1} + a_kc_1^k + \dots + a_1c_1 + a_0$$

$$R_{j_2}(A_1) = a_{k+1}c_2^{k+1} + a_kc_2^k + \dots + a_1c_2 + a_0$$

.....

$$R_{j_{k-1}}(A_1) = a_{k+1}c_k^{k+1} + a_kc_k^k + \dots + a_1c_k + a_0$$

$$R_{j_k}(A_1) = a_0$$

而得到 $k+1$ 次多项式 $f(x)$, 进而确定其排序及得分方法。但应注意, 投标报价在实际工作中允许有偏差, 所以采用这种方法同样需要规定出多大的报价偏差不影响排序结果。

4.2. 方案权函数

设方案的评价项目为 A_2 , 其评审指标为 $\{a_{21}, a_{22}, \dots, a_{2n_2}\}$ 。定量判断一个方案的优劣是比较困难的, 这不但是对招标人而言, 对评标专家也如此。方案的评审指标常常是不可比的, 所以通常采用对评审指标赋予不同分值的做法实际上不可取的, 因为我们很难解释清楚为什么一个方案得 96 分而另一个方案只能得 92 分。对方案的评审宜采用定性评审或在定性基础上的定量评审, 其权函数 $R_i(\omega(A_2)), 1 \leq i \leq k$ 可以取为线性函数

$$R_i(\omega(A_2)) = R_i(\omega(a_{21})) + R_i(\omega(a_{22})) + \dots + R_i(\omega(a_{2n_2})).$$

而对每个评审指标的权函数 $\omega(a_{2i}), 1 \leq i \leq n_2$ 宜采用定性评审基础上的定量评审, 不同的级别对应不同的权函数。

例如某招标项目的方案评审共设 4 个评审指标, 每个指标分为 A, B, C, D 四个级别, 得分标准表 7 所示。

评审指标	a_{21}	a_{22}	a_{23}	a_{24}
A	4	2	2	1
B	3	1.5	1.5	0.8
C	2	1	1	0.5
D	1	0.5	0.5	0.3

表 7. 方案档次及对应的得分

如果一个投标 R_i 的定性评审结果为 $R_i(\omega(a_{21})) = A, R_i(\omega(a_{22})) = B, R_i(\omega(a_{23})) = B, R_i(\omega(a_{24})) = A$, 则该投标人的方案得分为

$$\begin{aligned} R_i(\omega(A_2)) &= R_i(\omega(a_{21})) + R_i(\omega(a_{22})) + R_i(\omega(a_{23})) + R_i(\omega(a_{24})) \\ &= 4 + 3 + 1.5 + 1 = 9.5. \end{aligned}$$

从排序角度讲, 只要评审出方案的级别, 利用上一节的字典排序或图上作业法就可以确定出各投标人方案的排序结果。当然, 在这之前需确定出评审指标间的序关系, 不同的工程招标项目, 其方案评审指标的序关系是不一样的。

5. 几个需进一步讨论的问题

《中华人民共和国招标投标法》经过六年多的实践, 已经在中国招标投标领域法制化建设方面迈出了一大步, 但伴随着法律的实施, 也陆续暴露出一些在实际工作中必须解决的问题, 如不及时进行规范, 势必造成与法律初衷的背道而驰。这里, 我们对几个问题进行一些初步分析与讨论。

问题 1: 招标与合同管理得关系 毋庸置疑, 招标是为合同管理服务的手段而不是目的, 这两者之间的关系定位在法律层面上是十分清楚的。但近年的实践表明, 中国国内招标大有一种以形式代替内容, 以走手续、走程序代替合同管理的趋势, 直接造成了招标走过场、招标投标成本加大和工程投资控制失效。要想有效地解决好这个问题, 必须依据法律定位, 认识清招标与合同管理的问题, 加强招标人、投

标人、评标委员会成员和招标投标监管部门的法制化建设及专业理论的学习，各施其则，从而有效地制止招标投标过程中的不法行为，实现“公开、公平、公正和诚实信用”的招标投标原则，这当中，作为提出招标项目、制定招标规则的招标人是关键。实践表明，只要招标人依法办事，目前在招标投标领域暴露出来的问题基本上都可以在招标文件及其评价体系的制定和招标组织中得到有效地预防与解决。但如何对招标人进行有效制约，即如何在法律法规层面上处理好招标人违法则还存在较大空缺，需要引起后续法律修订及法规制订时充分注意。

问题 2: 评标标准的客观化 所谓评标标准的客观化问题，就是要求将所有的评价项目和评审指标给出客观评判标准与方法，进而依据多目标决策方法评审和推荐中标候选人。目前国内对投标报价和商务部分的评审基本上实现了客观评审（且不论其客观评审方法是否科学合理），但对技术部分，如技术方案、施工组织设计、技术规格等的评审则完全交给了评标委员会依据其主管判断评审的方法，直接造成了一些评审结果对投标人不公平和易于背后操作等违法违规事件的发生。这当中有其客观原因，但更主要的，在于评标委员会成员的来源和其专业素质不一，对同样一个投标的判断常常会得出不同的评判结果，尤其是在采用定量评审方法时暴露得更明显。当然，加强评标专家的业务培训和评标技能的训练能够部分地解决这个问题，但其根源在于将一些无法量化的评审指标交给了评标委员会去定量评审并做到公正、客观与科学本身就是一件十分困难的事情，加之专家的素质高低不平，极易于造成评标结果失真。在当前评标专家业务素质高低不平、缺乏评标技能条件下，加大资格预审的审查力度，将评标标准进行客观化或化多目标决策为单目标决策无疑是一种有效的解决途径，同时也符合法律法规初衷，以便将来条件成熟时全面进行多目标决策方式的评审。

问题 3: 定量与定性评审 国内一些地区的招标投标管理办法中强制规定了一些类别的项目必须采用定量评审。如前所述，定量评审的前提是评价项目之间存在统一的度量关系，可以量化处理。而绝大多数评价项目之间并不存在统一度量关系，结果造成招标文件中的评审标准的非量化和评标委员会的主观量化判定。对一些不能量化的评价项目，采用定性而不是定量评审的方法可以有效地解决这一个问题。一般而言，评标委员会成员对一个技术方案优劣的评审结果是可以采用评议、争论等方式达成共识的，比如判断一个方案的合格与否，是一个优秀方案还是一个合格方案对评标专家而言是能够胜任的，在这种条件下，对一些无法量化的评价项目，特别是技术部分的评审采用定性方式评审无疑是解决当前评标结果失真的有效手段，这当中还有许多细致的工作需要进行认真研究与思考，而规范市场行为，规范

参与招标活动的各方行为,采用科学决策的方式制定招标评价体系才是解决问题的根本,而这依赖于法制化建设,也依赖于参与招标活动的各方依法办事,话虽然很简单,但六年来贯彻《中华人民共和国招标投标法》的实践表明,这是一项长期而艰苦的工作。

参考文献

- [1] G.Chartrand and L.Lesniak, *Graphs & Digraphs*, Wadsworth, Inc., California, 1986.
- [2] 陈廷, 多目标决策方法, 现代工程数学手册, 第 IV 卷第 77 篇, 1357-1410, 华中工学院出版社, 1987.
- [3] P.C.Fishburn, *Utility Theory for Decision Making*, New York, Wiley, 1970.
- [4] D.L.Lu, X.S.Zhang and Y.Y.Mi, An offer model for civil engineering construction, *Chinese OR Transaction*, Vol.5, No.4(2001)41-52.
- [5] L.F.Mao, *On Automorphisms groups of Maps, Surfaces and Smarandache geometries*, *Sientia Magna*, Vol.1(2005), No.2, 55-73.
- [6] L.F.Mao, *Automorphism Groups of Maps, Surfaces and Smarandache Geometries*, American Research Press, 2005.
- [7] L.F.Mao, *Smarandache multi-space theory*, Hexis, Phoenix, AZ, 2006.
- [8] 毛林繁, 中国工程建设项目施工招标技巧与案例分析—Smarandache 重空间招标模型, Xiquan Publishing House (Chinese Branch), America, 2006.
- [9] F.Smarandache, Mixed noneuclidean geometries, *eprint arXiv: math/0010119*, 10/2000.
- [10] F.Smarandache, *A Unifying Field in Logics. Neutrosopy: Neturosophic Probability, Set, and Logic*, American research Press, Rehoboth, 1999.
- [11] F.Smarandache, Neutrosophy, a new Branch of Philosophy, *Multi-Valued Logic*, Vol.8, No.3(2002)(special issue on Neutrosophy and Neutrosophic Logic), 297-384.
- [12] F.Smarandache, A Unifying Field in Logic: Neutrosophic Field, *Multi-Valued Logic*, Vol.8, No.3(2002)(special issue on Neutrosophy and Neutrosophic Logic), 385-438.

21math-001-007



The Number of Complete Maps on Surfaces*

Linfan Mao

(Chinese Academy of Mathematics and System Science, Beijing 100080, P.R.China)

Yanpei Liu

(Institute of Applied Mathematics, Beijing Jiaotong University, Beijing,100044, P.R.China)

Feng Tian

(Chinese Academy of Mathematics and System Science, Beijing 100080, P.R.China)

Abstract: A map is a connected topological graph cellularly embedded in a surface and a complete map is a cellularly embedded complete graph in a surface. In this paper, all automorphisms of complete maps of order n are determined by permutations on its vertices. Applying a scheme for enumerating maps on surfaces with a given underlying graph, the numbers of unrooted complete maps on orientable or non-orientable surfaces are obtained.

曲面完全地图的计数

摘要. 一个地图是一个图在曲面上的 2-胞腔嵌入, 类似地, 一个完全地图则是一个完全图在曲面上的 2-胞腔嵌入。依完全图的顶点和置换群理论, 本文确定了 n 阶完全地图的所有自同构表示式, 并利用曲面上给定基础图得不标根地图计算模式, 得到了可定向与不可定向曲面上不标根完全地图的数目。

Key words: embedding, complete map, isomorphism, automorphism group, Burnside Lemma.

Classification: AMS(2000) 05C10,05C25, 05C30

¹Finished in May, 2004, e-print: *arXiv: math.GM/0607790*

1. Introduction

All surfaces considered in this paper are 2-dimensional compact closed manifolds without boundary, graphs are connected and simple graphs with the maximum valency ≥ 3 and groups are finite. For terminologies and notations not defined here can be seen in [21] for maps, [20] for graphs and in [2] for permutation groups.

The enumeration of rooted maps on surfaces, especially, the sphere, has been intensively investigated by many researchers after the Tutte's pioneer work in 1962 (see [21]). Comparing with rooted maps, observation for the enumeration of unrooted maps on surface is not much. By applying the automorphisms of the sphere, Liskovets gave an enumerative scheme for unrooted planar maps(see [12]). Liskovets, Walsh and Liskovets got many enumeration results for *general planar maps*, *regular planar maps*, *Eulerian planar maps*, *self-dual planar maps* and *2-connected planar maps*, etc (see [12] – [14]).

General results for the enumeration of unrooted maps on surface other than sphere are very few. Using the well known Burnside Lemma in permutation group theory, Biggs and White presented a formula for enumerating non-equivalent embeddings of a given graph on orientable surfaces^[2], which are the classification of embeddings by orientation-preserving automorphisms of orientable surfaces. Following their idea, the numbers of non-equivalent embeddings of complete graphs, complete bipartite graphs, wheels and graphs whose automorphism group action on its ordered pair of adjacent vertices is semi-regular are gotten in references [15] – [16], [20] and [11]. Although this formula is not very efficient and need more clarifying for the actual enumeration of non-equivalent embeddings of a graph, the same idea is more practical for enumerating rooted maps on orientable or non-orientable surfaces with given underlying graphs(see [8] – [10]).

For projective maps with a given 3-connected underlying graph, Negami got an enumeration result for non-equivalent embeddings by establishing the double planar covering of projective maps(see [18]). In [7], Jin Ho Kwak and Jaeun Lee obtained the number of non-congruent embeddings of a graph, which is also related to the topic discussed in this paper.

Combining the idea of Biggs and White for non-equivalent embeddings of a graph on orientable surfaces and the Tutte's algebraic representation for maps on

surface^{[19],[21]}, a general scheme for enumerating unrooted maps on locally orientable surfaces with a given underlying graph is obtained in this paper. Whence, the enumeration of unrooted maps on surfaces can be carried out by the following programming:

STEP 1. Determined all automorphisms of maps with a given underlying graph;

STEP 2. Calculation the the fixing set $Fix(\zeta)$ for each automorphism ζ of maps;

STEP 3. Enumerating the unrooted maps on surfaces with a given underlying graph by this scheme.

Notice that this programming can be used for orientable or non-orientable surfaces, respectively and get the numbers of orientable or non-orientable unrooted maps underlying a given graph.

The main purpose of this paper is to enumerate the orientable or non-orientable complete maps. In 1971, Biggs proved^[1] that the order of automorphism group of an orientable complete map of order n divides $n(n-1)$, and equal $n(n-1)$ only if the automorphism group of the complete map is a *Frobenius group*. In this paper, we get a representation by the permutation on its vertices for the automorphisms of orientable or non-orientable complete maps. Then as soon as we completely calculate the fixing set $Fix(\zeta)$ for each automorphism ζ of complete maps, the enumeration of unrooted orientable or non-orientable complete maps can be well done by our programming.

The problem of determining which automorphism of a graph is an automorphism of a map is also interesting for *Riemann* surfaces or *Klein* surfaces - surfaces equipped with an analytic or dianalytic structure, for example, automorphisms of Riemann or Klein surfaces have be given more attention since 1960s, see for example,[3] – [4], [6], [17], but it is difficult to get a concrete representation for an automorphism of Riemann or Klein surfaces. The approach used in this paper can be also used for combinatorial discussion automorphisms of Riemann or Klein surface.

Terminologies and notations used in this paper are standard. Some of them are mentioned in the following.

For a given connected graph Γ , an *embedding* of Γ is a pair (\mathcal{J}, λ) , where \mathcal{J} is a rotation system of Γ , and $\lambda : E(\Gamma) \rightarrow Z_2$. The edge with $\lambda(e) = 0$ or $\lambda(e) = 1$ is

called the *type 0* or *type 1 edge*, respectively.

A map $M = (\mathcal{X}_{\alpha,\beta}, \mathcal{P})$ is defined to be a permutation \mathcal{P} acting on $\mathcal{X}_{\alpha,\beta}$ of a disjoint union of quadricells Kx of $x \in X$, where, X is a finite set and $K = \{1, \alpha, \beta, \alpha\beta\}$ is the *Klein* group, satisfying the following conditions:

- i) $\forall x \in \mathcal{X}_{\alpha,\beta}$, there does not exist an integer k such that $\mathcal{P}^k x = \alpha x$;
- ii) $\alpha \mathcal{P} = \mathcal{P}^{-1} \alpha$;
- iii) the group $\Psi_J = \langle \alpha, \beta, \mathcal{P} \rangle$ is transitive on $\mathcal{X}_{\alpha,\beta}$.

According to the condition *ii*), the vertices of a map are defined to be the pairs of conjugate of \mathcal{P} action on $\mathcal{X}_{\alpha,\beta}$ and edges the orbits of K on $\mathcal{X}_{\alpha,\beta}$, for example, for $\forall x \in \mathcal{X}_{\alpha,\beta}$, $\{x, \alpha x, \beta x, \alpha\beta x\}$ is an edge of the map M . Geometrically, any map M is an embedding of a graph Γ on a surface, denoted by $M = M(\Gamma)$ and $\Gamma = \Gamma(M)$ (see also [19] – [21] for details). The graph Γ is called the underlying graph of the map M . If $r \in \mathcal{X}_{\alpha,\beta}$ is marked beforehand, then M is called a *rooted map*, denoted by M^r . A map is said non-orientable or orientable if the group $\Psi_I = \langle \alpha\beta, \mathcal{P} \rangle$ is transitive on $\mathcal{X}_{\alpha,\beta}$ or not.

For example, the graph K_4 on the tours with one face length 4 and another 8 , shown in the following Fig.1,

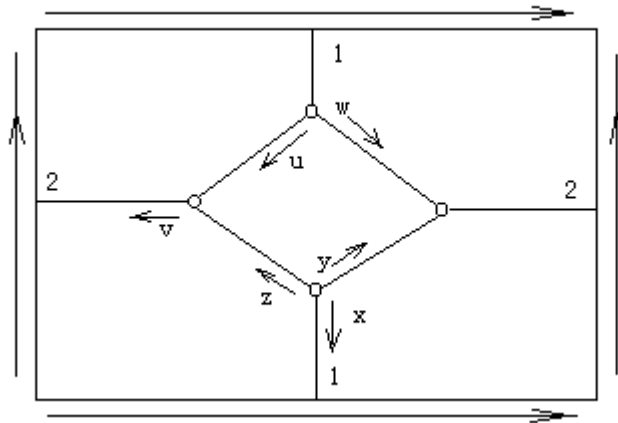

Fig.1

can be algebraically represented as follows:

A map $(\mathcal{X}_{\alpha,\beta}, \mathcal{P})$ with $\mathcal{X}_{\alpha,\beta} = \{x, y, z, u, v, w, \alpha x, \alpha y, \alpha z, \alpha u, \alpha v, \alpha w, \beta x, \beta y, \beta z, \beta u, \beta v, \beta w, \alpha\beta x, \alpha\beta y, \alpha\beta z, \alpha\beta u, \alpha\beta v, \alpha\beta w\}$ and

$$\begin{aligned} \mathcal{P} &= (x, y, z)(\alpha\beta x, u, w)(\alpha\beta z, \alpha\beta u, v)(\alpha\beta y, \alpha\beta v, \alpha\beta w) \\ &\times (\alpha x, \alpha z, \alpha y)(\beta x, \alpha w, \alpha u)(\beta z, \alpha v, \beta u)(\beta y, \beta w, \beta v) \end{aligned}$$

The four vertices of this map are $\{(x, y, z), (\alpha x, \alpha z, \alpha y)\}$, $\{(\alpha\beta x, u, w), (\beta x, \alpha w, \alpha u)\}$, $\{(\alpha\beta z, \alpha\beta u, v), (\beta z, \alpha v, \beta u)\}$ and $\{(\alpha\beta y, \alpha\beta v, \alpha\beta w), (\beta y, \beta w, \beta v)\}$ and six edges are $\{e, \alpha e, \beta e, \alpha\beta e\}$ for $\forall e \in \{x, y, z, u, v, w\}$.

Two maps $M_1 = (\mathcal{X}_{\alpha,\beta}^1, \mathcal{P}_1)$ and $M_2 = (\mathcal{X}_{\alpha,\beta}^2, \mathcal{P}_2)$ are said to be *isomorphic* if there exists a bijection $\tau : \mathcal{X}_{\alpha,\beta}^1 \longrightarrow \mathcal{X}_{\alpha,\beta}^2$ such that for $\forall x \in \mathcal{X}_{\alpha,\beta}^1, \tau\alpha(x) = \alpha\tau(x)$, $\tau\beta(x) = \beta\tau(x)$ and $\tau\mathcal{P}_1(x) = \mathcal{P}_2\tau(x)$. τ is called an *isomorphism* between them. If $M_1 = M_2 = M$, then an isomorphism between M_1 and M_2 is called an *automorphism* of M . All automorphisms of a map M form a group, called the *automorphism group* of M and denoted by $\text{Aut}M$. Similarly, two rooted maps M_1^r, M_2^r are said to be *isomorphic* if there is an isomorphism θ between them such that $\theta(r_1) = r_2$, where r_1, r_2 are the roots of M_1^r, M_2^r , respectively and denote the *automorphism group* of M^r by $\text{Aut}M^r$. It has been known that $\text{Aut}M^r$ is a trivial group.

According to their action, isomorphisms between maps can be divided into two classes: *cyclic order-preserving isomorphism* and *cyclic order-reversing isomorphism*, defined as follows, which is useful for determining automorphisms of a map underlying a graph.

For two maps M_1 and M_2 , a bijection ξ between M_1 and M_2 is said to be *cyclic order-preserving* if for $\forall x \in \mathcal{X}_{\alpha,\beta}^1, \tau\alpha(x) = \alpha\tau(x)$, $\tau\beta(x) = \beta\tau(x)$, $\tau\mathcal{P}_1(x) = \mathcal{P}_2\tau(x)$ and *cyclic order-reversing* if $\tau\alpha(x) = \alpha\tau(x)$, $\tau\beta(x) = \beta\tau(x)$, $\tau\mathcal{P}_1(x) = \mathcal{P}_2^{-1}\tau(x)$.

Now let Γ be a connected graph. The notations $\mathcal{E}^O(\Gamma)$, $\mathcal{E}^N(\Gamma)$ and $\mathcal{E}^L(\Gamma)$ denote the embeddings of Γ on the orientable surfaces, non-orientable surfaces and locally surfaces, $\mathcal{M}(\Gamma)$ and $\text{Aut}\Gamma$ denote the set of non-isomorphic maps underlying Γ and its automorphism group, respectively.

2. The enumerative scheme for maps underlying a graph

A permutation p on set Ω is called semi-regular if all of its orbits have the same length. For a given connected graph Γ , $\forall g \in \text{Aut}\Gamma$, $M = (\mathcal{X}_{\alpha,\beta}, \mathcal{P}) \in \mathcal{M}(\Gamma)$, define an extended action of g on M to be

$$g^* : \mathcal{X}_{\alpha,\beta} \longrightarrow \mathcal{X}_{\alpha,\beta},$$

such that $M^{g^*} = gMg^{-1}$ with $g\alpha = \alpha g$ and $g\beta = \beta g$.

We have already known the following two results.

Lemma 2.1^[21] *For any rooted map M^r , $\text{Aut}M^r$ is trivial.*

Lemma 2.2^{[2],[21]} *For a given map M , $\forall \xi \in \text{Aut}M$, ξ transforms vertices to vertices, edges to edges and faces to faces on a map M , i.e, ξ can be naturally extended to an automorphism of surfaces.*

Lemma 2.3 *If there is an isomorphism ξ between maps M_1 and M_2 , then $\Gamma(M_1) = \Gamma(M_2) = \Gamma$ and $\xi \in \text{Aut}\Gamma$ if ξ is cyclic order-preserving or $\xi\alpha \in \text{Aut}\Gamma$ if ξ is cyclic order-reversing.*

Proof By the definition of an isomorphism between maps, if $M_1 = (\mathcal{X}_{\alpha,\beta}^1, \mathcal{P}_1)$ is isomorphic with $M_2 = (\mathcal{X}_{\alpha,\beta}^2, \mathcal{P}_2)$, then there is an 1 – 1 mapping ξ between $\mathcal{X}_{\alpha,\beta}^1$ and $\mathcal{X}_{\alpha,\beta}^2$ such that $(\mathcal{P}_1)^\xi = \mathcal{P}_2$. Since isomorphic graphs are considered to be equal, we get that $\Gamma(M_1) = \Gamma(M_2) = \Gamma$. Now since

$$(\mathcal{P}_2)^{-1} = (\mathcal{P}_2)^\alpha.$$

We get that $\Gamma^\xi = \Gamma$ or $\Gamma^{\xi\alpha} = \Gamma$, whence, $\xi \in \text{Aut}\Gamma$ or $\xi\alpha \in \text{Aut}\Gamma$. \spadesuit

According to Lemma 2.3, For $\forall g \in \text{Aut}\Gamma, \forall M \in \mathcal{E}^L(\Gamma)$, the induced action g^* of g on M is defined by $M^{g^*} = gMg^{-1} = (\mathcal{X}_{\alpha,\beta}, g\mathcal{P}g^{-1})$.

Since \mathcal{P} is a permutation on the set $\mathcal{X}_{\alpha,\beta}$, by a simple result in permutation group theory, \mathcal{P}^g is just the permutation replaced each element x in \mathcal{P} by $g(x)$. Whence M and M^{g^*} are isomorphic. Therefore, we get the following enumerative theorem for unrooted maps underlying a graph.

Theorem 2.1 *For a connected graph Γ , let $\mathcal{E} \subset \mathcal{E}^L(\Gamma)$. Then the number $n(\mathcal{E}, \Gamma)$ of unrooted maps in \mathcal{E} is*

$$n(\mathcal{E}, \Gamma) = \frac{1}{|\text{Aut}\Gamma \times \langle \alpha \rangle|} \sum_{g \in \text{Aut}\Gamma \times \langle \alpha \rangle} |\Phi(g)|,$$

where, $\Phi(g) = \{\mathcal{P} | \mathcal{P} \in \mathcal{E} \text{ and } \mathcal{P}^g = \mathcal{P}\}$.

Proof According to Lemma 2.1, two maps $M_1, M_2 \in \mathcal{E}$ are isomorphic if and only if there exists an isomorphism $\theta \in \text{Aut}\Gamma \times \langle \alpha \rangle$ such that $M_1^{\theta*} = M_2$. Whence, we get that all the unrooted maps in \mathcal{E} are just the representations of orbits in \mathcal{E} under the action of $\text{Aut}\Gamma \times \langle \alpha \rangle$. By the Burnside Lemma, we get the following result for the number of unrooted maps in \mathcal{E}

$$n(\mathcal{E}, \Gamma) = \frac{1}{|\text{Aut}\Gamma \times \langle \alpha \rangle|} \sum_{g \in \text{Aut}\Gamma \times \langle \alpha \rangle} |\Phi(g)|. \quad \spadesuit$$

Corollary 2.1 *For a given graph Γ , the numbers of unrooted maps in $\mathcal{E}^O(\Gamma)$, $\mathcal{E}^N(\Gamma)$ and $\mathcal{E}^L(\Gamma)$ are*

$$n^O(\Gamma) = \frac{1}{|\text{Aut}\Gamma \times \langle \alpha \rangle|} \sum_{g \in \text{Aut}\Gamma \times \langle \alpha \rangle} |\Phi^O(g)|; \quad (2.1)$$

$$n^N(\Gamma) = \frac{1}{|\text{Aut}\Gamma \times \langle \alpha \rangle|} \sum_{g \in \text{Aut}\Gamma \times \langle \alpha \rangle} |\Phi^N(g)|; \quad (2.2)$$

$$n^L(\Gamma) = \frac{1}{|\text{Aut}\Gamma \times \langle \alpha \rangle|} \sum_{g \in \text{Aut}\Gamma \times \langle \alpha \rangle} |\Phi^L(g)|, \quad (2.3)$$

where, $\Phi^O(g) = \{\mathcal{P} | \mathcal{P} \in \mathcal{E}^O(\Gamma) \text{ and } \mathcal{P}^g = \mathcal{P}\}$, $\Phi^N(g) = \{\mathcal{P} | \mathcal{P} \in \mathcal{E}^N(\Gamma) \text{ and } \mathcal{P}^g = \mathcal{P}\}$, $\Phi^L(g) = \{\mathcal{P} | \mathcal{P} \in \mathcal{E}^L(\Gamma) \text{ and } \mathcal{P}^g = \mathcal{P}\}$.

Corollary 2.2 *Let $\mathcal{E}(S, \Gamma)$ be the embeddings of Γ in the surface S , then the number $n(\Gamma, S)$ of unrooted maps on S with underlying $g\Gamma$ is*

$$n(\Gamma, S) = \frac{1}{|\text{Aut}\Gamma \times \langle \alpha \rangle|} \sum_{g \in \text{Aut}\Gamma \times \langle \alpha \rangle} |\Phi(g)|,$$

where, $\Phi(g) = \{\mathcal{P} | \mathcal{P} \in \mathcal{E}(S, \Gamma) \text{ and } \mathcal{P}^g = \mathcal{P}\}$.

Corollary 2.3 *In formulae (2.1)-(2.3), $|\Phi(g)| \neq 0$ if and only if g is an automorphism of an orientable or non-orientable map underlying Γ .*

Directly using these formulae (2.1)-(2.3) to count unrooted maps with a given underlying graph is not straightforward. More observation should be considered. The following two lemmas give necessary conditions for an induced automorphism of a graph Γ to be an cyclic order-preserving automorphism of a surface.

Lemma 2.4 For a map M underlying a graph Γ , $\forall g \in \text{Aut}M, \forall x \in \mathcal{X}_{\alpha,\beta}$ with $X = E(\Gamma)$,

$$(i) \quad |x^{\text{Aut}M}| = |\text{Aut}M| ;$$

$$(ii) \quad |x^{<g>}| = o(g),$$

where, $o(g)$ denotes the order of g .

Proof For a subgroup $H < \text{Aut}M$, we know that $|H| = |x^H||H_x|$. Since $H_x < \text{Aut}M^x$, where M^x is a rooted map with root x , we know that $|H_x| = 1$ by Lemma 2.1. Whence, $|x^H| = |H|$. Now take $H = \text{Aut}M$ or $< g >$, we get the assertions (i) and (ii). \spadesuit

Lemma 2.5 Let Γ be a connected graph and $g \in \text{Aut}\Gamma$. If there is a map $M \in \mathcal{E}^L(\Gamma)$ such that the induced action $g^* \in \text{Aut}M$, then for $\forall (u, v), (x, y) \in E(\Gamma)$,

$$[l^g(u), l^g(v)] = [l^g(x), l^g(y)] = \text{constant},$$

where, $l^g(w)$ denotes the length of the cycle containing the vertex w in the cycle decomposition of g and $[a, b]$ the least common multiple of integers a and b .

Proof According to Lemma 2.4, we know that the length of any quadricell u^{v+} or u^{v-} under the action of g^* is $[l^g(u), l^g(v)]$. Since g^* is an automorphism of map, therefore, g^* is semi-regular. Whence, we get that

$$[l^g(u), l^g(v)] = [l^g(x), l^g(y)] = \text{constant}. \quad \spadesuit$$

Now we consider conditions for an induced automorphism of a map by an automorphism of graph to be a cyclic order-reversing automorphism of surfaces.

Lemma 2.6 If $\xi\alpha$ is an automorphism of a map, then $\xi\alpha = \alpha\xi$.

Proof Since $\xi\alpha$ is an automorphism of a map, we know that

$$(\xi\alpha)\alpha = \alpha(\xi\alpha).$$

That is, $\xi\alpha = \alpha\xi$. \spadesuit

Lemma 2.7 If ξ is an automorphism of $M = (\mathcal{X}_{\alpha,\beta}, \mathcal{P})$, then $\xi\alpha$ is semi-regular on $\mathcal{X}_{\alpha,\beta}$ with order $o(\xi)$ if $o(\xi) \equiv 0 \pmod{2}$ or $2o(\xi)$ if $o(\xi) \equiv 1 \pmod{2}$.

Proof Since ξ is an automorphism of map by Lemma 2.6, we know that the cycle decomposition of ξ can be represented by

$$\xi = \prod_k (x_1, x_2, \dots, x_k)(\alpha x_1, \alpha x_2, \dots, \alpha x_k),$$

where, \prod_k denotes the product of disjoint cycles with length $k = o(\xi)$.

Therefore, if $k \equiv 0(\text{mod}2)$, we get that

$$\xi\alpha = \prod_k (x_1, \alpha x_2, x_3, \dots, \alpha x_k)$$

and if $k \equiv 1(\text{mod}2)$, we get that

$$\xi\alpha = \prod_{2k} (x_1, \alpha x_2, x_3, \dots, x_k, \alpha x_1, x_2, \alpha x_3, \dots, \alpha x_k).$$

Whence, ξ is semi-regular acting on $\mathcal{X}_{\alpha,\beta}$. \spadesuit

Now we can prove the following result for cyclic order-reversing automorphisms of maps.

Lemma 2.8 *For a connected graph Γ , let \mathcal{K} be all automorphisms in $\text{Aut}\Gamma$ whose extending action on $\mathcal{X}_{\alpha,\beta}$, $X = E(\Gamma)$, are automorphisms of maps underlying the graph Γ . Then for $\forall \xi \in \mathcal{K}$, $o(\xi^*) \geq 2$, $\xi^*\alpha \in \mathcal{K}$ if and only if $o(\xi^*) \equiv 0(\text{mod}2)$.*

Proof Notice that by Lemma 2.7, if ξ^* is an automorphism of a map underlying Γ , then $\xi^*\alpha$ is semi-regular acting on $\mathcal{X}_{\alpha,\beta}$.

Assume ξ^* is an automorphism of the map $M = (\mathcal{X}_{\alpha,\beta}, \mathcal{P})$. Without loss of generality, we assume that

$$\mathcal{P} = C_1 C_2 \cdots C_k,$$

where, $C_i = (x_{i1}, x_{i2}, \dots, x_{ij_i})$ is a cycle in the decomposition of $\xi|_{V(\Gamma)}$ and $x_{it} = \{(e^{i1}, e^{i2}, \dots, e^{iti})(\alpha e^{i1}, \alpha e^{iti}, \dots, \alpha e^{i2})\}$,

$$\xi|_{E(\Gamma)} = (e_{11}, e_{12}, \dots, e_{s_1})(e_{21}, e_{22}, \dots, e_{2s_2}) \cdots (e_{l1}, e_{l2}, \dots, e_{ls_l}),$$

and

$$\xi^* = C(\alpha C^{-1}\alpha),$$

where, $C = (e_{11}, e_{12}, \dots, e_{s_1})(e_{21}, e_{22}, \dots, e_{2s_2}) \cdots (e_{l1}, e_{l2}, \dots, e_{ls_l})$. Now since ξ^* is an automorphism of a map, we get that $s_1 = s_2 = \dots = s_l = o(\xi^*) = s$.

If $o(\xi^*) \equiv 0(mod 2)$, define a map $M^* = (\mathcal{X}_{\alpha, \beta}, \mathcal{P}^*)$ with

$$\mathcal{P}^* = C_1^* C_2^* \cdots C_k^*,$$

where, $C_i^* = (x_{i1}^*, x_{i2}^*, \dots, x_{ij_i}^*)$, $x_{it}^* = \{(e_{i1}^*, e_{i2}^*, \dots, e_{it_i}^*)(\alpha e_{i1}^*, \alpha e_{it_i}^*, \dots, e_{i2}^*)\}$ and $e_{ij}^* = e_{pq}$. Take $e_{ij}^* = e_{pq}$ if $q \equiv 1(mod 2)$ and $e_{ij}^* = \alpha e_{pq}$ if $q \equiv 0(mod 2)$. Then we get that $M^{\xi\alpha} = M$.

Now if $o(\xi^*) \equiv 1(mod 2)$, by Lemma 2.7, $o(\xi^*\alpha) = 2o(\xi^*)$. Therefore, for a chosen quadricell in $(e^{i1}, e^{i2}, \dots, e^{iti})$ adjacent to the vertex x_{i1} for $i = 1, 2, \dots, n$, where, n = the order of the graph Γ , the resultant map M is unstable under the action of $\xi\alpha$. Whence, $\xi\alpha$ is not an automorphism of a map underlying Γ . \spadesuit

3. Determine automorphisms of complete maps

Now we determine all automorphisms of complete maps in this section by applying the results gotten in Section 2.

Let K_n be a complete graph of order n . Label its vertices by integers $1, 2, \dots, n$. Then its edge set is $\{ij | 1 \leq i, j \leq n, i \neq j \text{ and } ij = ji\}$. For convenience, we use i^j denoting an edge ij of the complete graph K_n and $i^j = j^i, 1 \leq i, j \leq n, i \neq j$. Then its quadricells of this edge can be represented by $\{i^{j+}, i^{j-}, j^{i+}, j^{i-}\}$ and

$$\mathcal{X}_{\alpha, \beta}(K_n) = \{i^{j+} : 1 \leq i, j \leq n, i \neq j\} \cup \{i^{j-} : 1 \leq i, j \leq n, i \neq j\},$$

$$\alpha = \prod_{1 \leq i, j \leq n, i \neq j} (i^{j+}, i^{j-}),$$

$$\beta = \prod_{1 \leq i, j \leq n, i \neq j} (i^{j+}, i^{j+})(i^{j-}, i^{j-}).$$

Recall that the automorphism group of K_n is just the symmetry group of degree n , i.e., $\text{Aut}K_n = S_n$. The above representation enables us to determine all automorphisms of complete maps of order n on surfaces.

Theorem 3.1 *All cyclic order-preserving automorphisms of non-orientable complete maps of order ≥ 4 are extended actions of elements in*

$$\mathcal{E}_{[s \frac{n}{s}]}, \quad \mathcal{E}_{[1, s \frac{n-1}{s}]},$$

and all cyclic order-reversing automorphisms of non-orientable complete maps of order ≥ 4 are extended actions of elements in

$$\alpha\mathcal{E}_{[(2s) \frac{n}{2s}]}, \quad \alpha\mathcal{E}_{[(2s) \frac{4}{2s}]}, \quad \alpha\mathcal{E}_{[1,1,2]},$$

where, \mathcal{E}_θ denotes the conjugate class containing element θ in the symmetry group S_n

Proof Firstly, we prove that the induced permutation ξ^* on complete map of order n by an element $\xi \in S_n$ is an cyclic order-preserving automorphism of a non-orientable map, if, and only if,

$$\xi \in \mathcal{E}_{s \frac{n}{s}} \cup \mathcal{E}_{[1, s \frac{n-1}{s}]}$$

Assume the cycle index of ξ is $[1^{k_1}, 2^{k_2}, \dots, n^{k_n}]$. If there exist two integers $k_i, k_j \neq 0$, and $i, j \geq 2, i \neq j$, then in the cycle decomposition of ξ , there are two cycles

$$(u_1, u_2, \dots, u_i) \quad \text{and} \quad (v_1, v_2, \dots, v_j).$$

Since

$$[l^\xi(u_1), l^\xi(u_2)] = i \quad \text{and} \quad [l^\xi(v_1), l^\xi(v_2)] = j$$

and $i \neq j$, we know that ξ^* is not an automorphism of embedding by Lemma 2.5. Whence, the cycle index of ξ must be the form of $[1^k, s^l]$.

Now if $k \geq 2$, let $(u), (v)$ be two cycles of length 1 in the cycle decomposition of ξ . By Lemma 2.5, we know that

$$[l^\xi(u), l^\xi(v)] = 1.$$

If there is a cycle (w, \dots) in the cycle decomposition of ξ whose length greater or equal to two, we get that

$$[l^\xi(u), l^\xi(w)] = [1, l^\xi(w)] = l^\xi(w).$$

According to Lemma 2.5, we get that $l^\xi(w) = 1$, a contradiction. Therefore, the cycle index of ξ must be the forms of $[s^l]$ or $[1, s^l]$. Whence, $sl = n$ or $sl + 1 = n$. Calculation shows that $l = \frac{n}{s}$ or $l = \frac{n-1}{s}$. That is, the cycle index of ξ is one of the following three types $[1^n]$, $[1, s^{\frac{n-1}{s}}]$ and $[s^{\frac{n}{s}}]$ for some integer s .

Now we only need to prove that for each element ξ in $\mathcal{E}_{[1, s^{\frac{n-1}{s}}]}$ and $\mathcal{E}_{[s^{\frac{n}{s}}]}$, there exists an non-orientable complete map M of order n with an induced permutation ξ^* being its cyclic order-preserving automorphism of surface. The discussion are divided into two cases.

Case 1 $\xi \in \mathcal{E}_{[s^{\frac{n}{s}}]}$

Assume the cycle decomposition of ξ being $\xi = (a, b, \dots, c) \dots (x, y, \dots, z) \dots (u, v, \dots, w)$, where, the length of each cycle is k , and $1 \leq a, b, \dots, c, x, y, \dots, z, u, v, \dots, w \leq n$. In this case, we can construct a non-orientable complete map $M_1 = (\mathcal{X}_{\alpha, \beta}^1, \mathcal{P}_1)$ as follows.

$$\mathcal{X}_{\alpha, \beta}^1 = \{i^{j^+} : 1 \leq i, j \leq n, i(j)\} \cup \{i^{j^-} : 1 \leq i, j \leq n, i \neq j\},$$

$$\mathcal{P}_1 = \prod_{x \in \{a, b, \dots, c, \dots, x, y, \dots, z, u, v, \dots, w\}} (C(x))(\alpha C(x)^{-1} \alpha),$$

where,

$$C(x) = (x^{a^+}, \dots, x^{x^*}, \dots, x^{u^+}, x^{b^+}, x^{y^+}, \dots, \dots, x^{v^+}, x^{c^+}, \dots, x^{z^+}, \dots, x^{w^+}),$$

x^{x^*} denotes an empty position and

$$\alpha C(x)^{-1} \alpha = (x^{a^-}, x^{w^-}, \dots, x^{z^-}, \dots, x^{c^-}, x^{v^-}, \dots, x^{b^-}, x^{u^-}, \dots, x^{y^-}, \dots).$$

It is clear that $M_1^{\xi^*} = M_1$. Therefore, ξ^* is an cyclic order-preserving automorphism of the map M_1 .

Case 2 $\xi \in \mathcal{E}_{[1, s^{\frac{n-1}{s}}]}$

We assume the cycle decomposition of ξ being

$$\xi = (a, b, \dots, c) \dots (x, y, \dots, z) \dots (u, v, \dots, w)(t),$$

where, the length of each cycle is k beside the final cycle, and $1 \leq a, b \dots c, x, y \dots, z, u, v, \dots, w, t \leq n$. In this case, we construct a non-orientable complete map $M_2 = (\mathcal{X}_{\alpha, \beta}^2, \mathcal{P}_2)$ as follows.

$$\mathcal{X}_{\alpha, \beta}^2 = \{i^{j^+} : 1 \leq i, j \leq n, i \neq j\} \cup \{i^{j^-} : 1 \leq i, j \leq n, i \neq j\},$$

$$\mathcal{P}_2 = (A)(\alpha A^{-1}) \prod_{x \in \{a, b, \dots, c, \dots, x, y, \dots, z, u, v, \dots, w\}} (C(x))(\alpha C(x)^{-1} \alpha),$$

where,

$$A = (t^{a^+}, t^{x^+}, \dots, t^{u^+}, t^{b^+}, t^{y^+}, \dots, t^{v^+}, \dots, t^{c^+}, t^{z^+}, \dots, t^{w^+}),$$

$$\alpha A^{-1} \alpha = (t^{a^-}, t^{w^-}, \dots, t^{z^-}, t^{c^-}, t^{v^-}, \dots, t^{y^-}, \dots, t^{b^-}, t^{u^-}, \dots, t^{x^-}),$$

$$C(x) = (x^{a^+}, \dots, x^{x^*}, \dots, x^{u^+}, x^{b^+}, \dots, x^{y^+}, \dots, x^{v^+}, \dots, x^{c^+}, \dots, x^{z^+}, \dots, x^{w^+})$$

and

$$\alpha C(x)^{-1} \alpha = (x^{a^-}, x^{w^-}, \dots, x^{z^-}, \dots, x^{c^-}, \dots, x^{v^-}, \dots, x^{y^-}, \dots, x^{b^-}, x^{u^-}, \dots).$$

It is also clear that $M_2^{\xi^*} = M_2$. Therefore, ξ^* is an automorphism of the map M_2 .

Now we consider the case of cyclic order-reversing automorphisms of a complete map. According to Lemma 2.8, we know that an element $\xi \alpha$, where, $\xi \in S_n$, is an cyclic order-reversing automorphism of a complete map only if,

$$\xi \in \mathcal{E}_{[k^{\frac{n_1}{k}}, (2k)^{\frac{n-n_1}{2k}}]}.$$

Our discussion is divided into two parts.

Case 3 $n_1 = n$

Without loss of generality, we can assume the cycle decomposition of ξ has the following form in this case.

$$\xi = (1, 2, \dots, k)(k+1, k+2, \dots, 2k) \cdots (n-k+1, n-k+2, \dots, n).$$

Subcase 3.1 $k \equiv 1(\text{mod}2)$ and $k > 1$

According to Lemma 2.8, we know that $\xi^*\alpha$ is not an automorphism of maps since $o(\xi^*) = k \equiv 1(\text{mod}2)$.

Subcase 3.2 $k \equiv 0(\text{mod}2)$

Construct a non-orientable map $M_3 = (\mathcal{X}_{\alpha, \beta}^3, \mathcal{P}_3)$, where $X^3 = E(K_n)$ and

$$\mathcal{P}_3 = \prod_{i \in \{1, 2, \dots, n\}} (C(i))(\alpha C(i)^{-1} \alpha),$$

where, if $i \equiv 1(\text{mod}2)$, then

$$C(i) = (i^{1+}, i^{k+1+}, \dots, i^{n-k+1+}, i^{2+}, \dots, i^{n-k+2+}, \dots, i^{i^*}, \dots, i^{k+}, i^{2k+}, \dots, i^{n+}),$$

$$\alpha C(i)^{-1} \alpha = (i^{1-}, i^{n-}, \dots, i^{2k-}, i^{k-}, \dots, i^{k+1-})$$

and if $i \equiv 0(\text{mod}2)$, then

$$C(i) = (i^{1-}, i^{k+1-}, \dots, i^{n-k+1-}, i^{2-}, \dots, i^{n-k+2-}, \dots, i^{i^*}, \dots, i^{k-}, i^{2k-}, \dots, i^{n-}),$$

$$\alpha C(i)^{-1} \alpha = (i^{1+}, i^{n+}, \dots, i^{2k+}, i^{k+}, \dots, i^{k+1+}).$$

Where, i^{i^*} denotes the empty position, for example, $(2^1, 2^{2^*}, 2^3, 2^4, 2^5) = (2^1, 2^3, 2^4, 2^5)$. It is clear that $\mathcal{P}_3^{\xi\alpha} = \mathcal{P}_3$, that is, $\xi\alpha$ is an automorphism of map M_3 .

Case 4 $n_1 \neq n$

Without loss of generality, we can assume that

$$\begin{aligned} \xi &= (1, 2, \dots, k)(k+1, k+2, \dots, n_1) \cdots (n_1 - k + 1, n_1 - k + 2, \dots, n_1) \\ &\times (n_1 + 1, n_1 + 2, \dots, n_1 + 2k)(n_1 + 2k + 1, \dots, n_1 + 4k) \cdots (n - 2k + 1, \dots, n) \end{aligned}$$

Subcase 4.1 $k \equiv 0(mod 2)$

Consider the orbits of 1^{2+} and $n_1 + 2k + 1^{1+}$ under the action of $\langle \xi\alpha \rangle$, we get that

$$|orb((1^{2+})^{\langle \xi\alpha \rangle})| = k$$

and

$$|orb(((n_1 + 2k + 1)^{1+})^{\langle \xi\alpha \rangle})| = 2k.$$

Contradicts to Lemma 2.5.

Subcase 4.2 $k \equiv 1(mod 2)$

In this case, if $k \neq 1$, then $k \geq 3$. Similar to the discussion of Subcase 3.1, we know that $\xi\alpha$ is not an automorphism of complete map. Whence, $k = 1$ and

$$\xi \in \mathcal{E}_{[1^{n_1}, 2^{n_2}]}$$

Without loss of generality, assume that

$$\xi = (1)(2) \cdots (n_1)(n_1 + 1, n_1 + 2)(n_1 + 3, n_1 + 4) \cdots (n_1 + n_2 - 1, n_1 + n_2).$$

If $n_2 \geq 2$, and there exists a map $M = (\mathcal{X}_{\alpha, \beta}, \mathcal{P})$, assume the vertex v_1 in M being

$$v_1 = (1^{l_{12}^+}, 1^{l_{13}^+}, \dots, 1^{l_{1n}^+})(1^{l_{12}^-}, 1^{l_{1n}^-}, \dots, 1^{l_{13}^-})$$

where, $l_{1i} \in \{+2, -2, +3, -3, \dots, +n, -n\}$ and $l_{1i} \neq l_{1j}$ if $i \neq j$.

Then we get that

$$(v_1)^{\xi\alpha} = (1^{l_{12}^-}, 1^{l_{13}^-}, \dots, 1^{l_{1n}^-})(1^{l_{12}^+}, 1^{l_{1n}^+}, \dots, 1^{l_{13}^+}) \neq v_1.$$

Whence, $\xi\alpha$ is not an automorphism of map M , a contradiction.

Therefore, $n_2 = 1$. Similarly, we can also get that $n_1 = 2$. Whence, $\xi = (1)(2)(34)$ and $n = 4$. We construct a stable non-orientable map M_4 under the action of $\xi\alpha$ as follows.

$$M_4 = (\mathcal{X}_{\alpha,\beta}^4, \mathcal{P}_4),$$

where,

$$\begin{aligned} \mathcal{P}_4 &= (1^{2+}, 1^{3+}, 1^{4+})(2^{1+}, 2^{3+}, 2^{4+})(3^{1+}, 3^{2+}, 3^{4+})(4^{1+}, 4^{2+}, 4^{3+}) \\ &\times (1^{2-}, 1^{4-}, 1^{3-})(2^{1-}, 2^{4-}, 2^{3-})(3^{1-}, 3^{4-}, 3^{2-})(4^{1-}, 4^{3-}, 4^{2-}). \end{aligned}$$

Therefore, all cyclic order-preserving automorphisms of non-orientable complete maps are extended actions of elements in

$$\mathcal{E}_{[s, \frac{n}{s}]}, \quad \mathcal{E}_{[1, s, \frac{n-1}{s}]}$$

and all cyclic order-reversing automorphisms of non-orientable complete maps are extended actions of elements in

$$\alpha\mathcal{E}_{[(2s), \frac{n}{2s}]}, \quad \alpha\mathcal{E}_{[(2s), \frac{4}{2s}]}, \quad \alpha\mathcal{E}_{[1,1,2]}.$$

This completes the proof. \spadesuit

According to the Rotation Embedding Scheme for orientable embedding of a graph formalized by Edmonds in [5], each orientable complete map is just the case of eliminating the signs “+,-” in our representation for complete maps. Whence, we also get the following result for automorphisms of orientable complete maps, which is similar to Theorem 3.1.

Theorem 3.2 *All cyclic order-preserving automorphisms of orientable complete maps of order ≥ 4 are extended actions of elements in*

$$\mathcal{E}_{[s, \frac{n}{s}]}, \quad \mathcal{E}_{[1, s, \frac{n-1}{s}]}$$

and all cyclic order-reversing automorphisms of orientable complete maps of order ≥ 4 are extended actions of elements in

$$\alpha\mathcal{E}_{[(2s), \frac{n}{2s}]}, \quad \alpha\mathcal{E}_{[(2s), \frac{4}{2s}]}, \quad \alpha\mathcal{E}_{[1,1,2]},$$

where, \mathcal{E}_θ denotes the conjugate class containing θ in S_n .

Proof The proof is similar to that of Theorem 3.1. For completion, we only need to construct orientable maps $M_i^O, i = 1, 2, 3, 4$ to replace these non-orientable maps $M_i, i = 1, 2, 3, 4$ in the proof of Theorem 3.1.

In fact, for cyclic order-preserving case, we only need to take M_1^O, M_2^O to be the resultant maps eliminating the signs $+ -$ in M_1, M_2 constructed in the proof of Theorem 3.1.

For the cyclic order-reversing case, we take $M_3^O = (E(K_n)_{\alpha,\beta}, \mathcal{P}_3^O)$ with

$$\mathcal{P}_3 = \prod_{i \in \{1,2,\dots,n\}} (C(i)),$$

where, if $i \equiv 1(\text{mod}2)$, then

$$C(i) = (i^1, i^{k+1}, \dots, i^{n-k+1}, i^2, \dots, i^{n-k+2}, \dots, i^{i^*}, \dots, i^k, i^{2k}, \dots, i^n),$$

and if $i \equiv 0(\text{mod}2)$, then

$$C(i) = (i^1, i^{k+1}, \dots, i^{n-k+1}, i^2, \dots, i^{n-k+2}, \dots, i^{i^*}, \dots, i^k, i^{2k}, \dots, i^n)^{-1},$$

where i^{i^*} denotes the empty position and $M_4^O = (E(K_4)_{\alpha,\beta}, \mathcal{P}_4)$ with

$$\mathcal{P}_4 = (1^2, 1^3, 1^4)(2^1, 2^3, 2^4)(3^1, 3^4, 3^2)(4^1, 4^2, 4^3).$$

It can be shown that $(M_i^O)^{g^*} = M_i^O, i = 1, 2$ and $(M_i^O)^{\xi\alpha} = M_i^O$ for $i = 3, 4$. \square

All results in this section are useful for the enumeration of complete maps in the next section.

4. The Enumeration of complete maps on surfaces

We firstly consider the permutation and its stabilizer . The permutation with the following form $(x_1, x_2, \dots, x_n)(\alpha x_n, \alpha x_2, \dots, \alpha x_1)$ is called a pair permutation. The following result is obvious.

Lemma 4.1 *Let g be a permutation on the set $\Omega = \{x_1, x_2, \dots, x_n\}$ such that $g\alpha = \alpha g$. If*

$$g(x_1, x_2, \dots, x_n)(\alpha x_n, \alpha x_{n-1}, \dots, \alpha x_1)g^{-1} = (x_1, x_2, \dots, x_n)(\alpha x_n, \alpha x_{n-1}, \dots, \alpha x_1),$$

then

$$g = (x_1, x_2, \dots, x_n)^k$$

and if

$$g\alpha(x_1, x_2, \dots, x_n)(\alpha x_n, \alpha x_{n-1}, \dots, \alpha x_1)(g\alpha)^{-1} = (x_1, x_2, \dots, x_n)(\alpha x_n, \alpha x_{n-1}, \dots, \alpha x_1),$$

then

$$g\alpha = (\alpha x_n, \alpha x_{n-1}, \dots, \alpha x_1)^k$$

for some integer $k, 1 \leq k \leq n$.

Lemma 4.2 For each permutation $g, g \in \mathcal{E}_{[k \frac{n}{k}]}$ satisfying $g\alpha = \alpha g$ on the set $\Omega = \{x_1, x_2, \dots, x_n\}$, the number of stable pair permutations in Ω under the action of g or $g\alpha$ is

$$\frac{2\phi(k)(n-1)!}{|\mathcal{E}_{[k \frac{n}{k}]}|},$$

where $\phi(k)$ denotes the Euler function.

Proof Denote the number of stable pair permutations under the action of g or $g\alpha$ by $n(g)$ and \mathcal{C} the set of pair permutations. Define the set $A = \{(g, C) | g \in \mathcal{E}_{[k \frac{n}{k}]}, C \in \mathcal{C} \text{ and } C^g = C \text{ or } C^{g\alpha} = C\}$. Clearly, for $\forall g_1, g_2 \in \mathcal{E}_{[k \frac{n}{k}]}$, we have $n(g_1) = n(g_2)$. Whence, we get that

$$|A| = |\mathcal{E}_{[k \frac{n}{k}]}|n(g). \tag{4.1}$$

On the other hand, by Lemma 4.1, for any pair permutation $C = (x_1, x_2, \dots, x_n)(\alpha x_n, \alpha x_{n-1}, \dots, \alpha x_1)$, since C is stable under the action of g , there must be $g = (x_1, x_2, \dots, x_n)^l$ or $g\alpha = (\alpha x_n, \alpha x_{n-1}, \dots, \alpha x_1)^l$, where $l = s\frac{n}{k}, 1 \leq s \leq k$ and $(s, k) = 1$. Therefore, there are $2\phi(k)$ permutations in $\mathcal{E}_{[k \frac{n}{k}]}$ acting on it stable. Whence, we also have

$$|A| = 2\phi(k)|\mathcal{C}|. \quad (4.2)$$

Combining (4.1) with (4.2), we get that

$$n(g) = \frac{2\phi(k)|\mathcal{C}|}{|\mathcal{E}_{[k \frac{n}{k}]}|} = \frac{2\phi(k)(n-1)!}{|\mathcal{E}_{[k \frac{n}{k}]}|}. \quad \natural$$

Now we can enumerate the unrooted complete maps on surfaces.

Theorem 4.1 *The number $n^L(K_n)$ of complete maps of order $n \geq 5$ on surfaces is*

$$n^L(K_n) = \frac{1}{2} \left(\sum_{k|n} + \sum_{k|n, k \equiv 0 \pmod{2}} \right) \frac{2^{\alpha(n,k)} (n-2)! \frac{n}{k}}{k^{\frac{n}{k}} \left(\frac{n}{k}\right)!} + \sum_{k|(n-1), k \neq 1} \frac{\phi(k) 2^{\beta(n,k)} (n-2)! \frac{n-1}{k}}{n-1},$$

where,

$$\alpha(n, k) = \begin{cases} \frac{n(n-3)}{2k}, & \text{if } k \equiv 1 \pmod{2}; \\ \frac{n(n-2)}{2k}, & \text{if } k \equiv 0 \pmod{2}, \end{cases}$$

and

$$\beta(n, k) = \begin{cases} \frac{(n-1)(n-2)}{2k}, & \text{if } k \equiv 1 \pmod{2}; \\ \frac{(n-1)(n-3)}{2k}, & \text{if } k \equiv 0 \pmod{2}. \end{cases}$$

and $n^L(K_4) = 11$.

Proof According to (2.3) in Corollary 2.1 and Theorem 3.1 for $n \geq 5$, we know that

$$\begin{aligned} n^L(K_n) &= \frac{1}{2|\text{Aut}K_n|} \times \left(\sum_{g_1 \in \mathcal{E}_{[k \frac{n}{k}]}^n} |\Phi(g_1)| + \sum_{g_2 \in \mathcal{E}_{[(2s) \frac{n}{2s}]}^n} |\Phi(g_2\alpha)| \right) \\ &+ \sum_{h \in \mathcal{E}_{[1, k \frac{n-1}{k}]}^{n-1}} |\Phi(h)| \\ &= \frac{1}{2n!} \times \left(\sum_{k|n} |\mathcal{E}_{[k \frac{n}{k}]}^n| |\Phi(g_1)| + \sum_{l|n, l \equiv 0 \pmod{2}} |\mathcal{E}_{[l \frac{n}{l}]}^n| |\Phi(g_2\alpha)| \right) \\ &+ \sum_{l|(n-1)} |\mathcal{E}_{[1, l \frac{n-1}{l}]}^{n-1}| |\Phi(h)|, \end{aligned}$$

where, $g_1 \in \mathcal{E}_{[k \frac{n}{k}]}$, $g_2 \in \mathcal{E}_{[l \frac{n}{l}]}$ and $h \in \mathcal{E}_{[1, k \frac{n-1}{k}]}$ are three chosen elements.

Without loss of generality, we assume that an element $g, g \in \mathcal{E}_{[k \frac{n}{k}]}$ has the following cycle decomposition.

$$g = (1, 2, \dots, k)(k + 1, k + 2, \dots, 2k) \dots ((\frac{n}{k} - 1)k + 1, (\frac{n}{k} - 1)k + 2, \dots, n)$$

and

$$\mathcal{P} = \prod_1 \times \prod_2,$$

where,

$$\prod_1 = (1^{i_{21}}, 1^{i_{31}}, \dots, 1^{i_{n1}})(2^{i_{12}}, 2^{i_{32}}, \dots, 2^{i_{n2}}) \dots (n^{i_{1n}}, n^{i_{2n}}, \dots, n^{i_{(n-1)n}}),$$

and

$$\prod_2 = \alpha(\prod_1^{-1})\alpha^{-1}$$

being a complete map which is stable under the action of g , where $s_{ij} \in \{k+, k- | k = 1, 2, \dots, n\}$.

Notice that the quadricells adjacent to the vertex "1" can make $2^{n-2}(n-2)!$ different pair permutations and for each chosen pair permutation, the pair permutations adjacent to the vertices $2, 3, \dots, k$ are uniquely determined since \mathcal{P} is stable under the action of g .

Similarly, for each given pair permutation adjacent to the vertex $k+1, 2k+1, \dots, (\frac{n}{k}-1)k+1$, the pair permutations adjacent to $k+2, k+3, \dots, 2k$ and $2k+2, 2k+3, \dots, 3k$ and, ..., and $(\frac{n}{k}-1)k+2, (\frac{n}{k}-1)k+3, \dots, n$ are also uniquely determined because \mathcal{P} is stable under the action of g .

Now for an orientable embedding M_1 of K_n , all the induced embeddings by exchanging two sides of some edges and retaining the others unchanged in M_1 are the same as M_1 by the definition of maps. Whence, the number of different stable embeddings under the action of g gotten by exchanging x and αx in M_1 for $x \in U, U \subset \mathcal{X}_\beta$, where $\mathcal{X}_\beta = \bigcup_{x \in E(K_n)} \{x, \beta x\}$, is $2^{g(\varepsilon) - \frac{n}{k}}$, where $g(\varepsilon)$ is the number of orbits of $E(K_n)$ under the action of g and we subtract $\frac{n}{k}$ because we can chosen $1^{2+}, k+1^{1+}, 2k+1^{1+}, \dots, n-k+1^{1+}$ first in our enumeration.

Notice that the length of each orbit under the action of g is k for $\forall x \in E(K_n)$ if k is odd and is $\frac{k}{2}$ for $x = i^{i+\frac{k}{2}}, i = 1, k+1, \dots, n-k+1$, or k for all other edges if k is even. Therefore, we get that

$$g(\varepsilon) = \begin{cases} \frac{\varepsilon(K_n)}{k}, & \text{if } k \equiv 1(\text{mod}2); \\ \frac{\varepsilon(K_n) - \frac{n}{2}}{k}, & \text{if } k \equiv 0(\text{mod}2). \end{cases}$$

Whence, we have that

$$\alpha(n, k) = g(\varepsilon) - \frac{n}{k} = \begin{cases} \frac{n(n-3)}{2k}, & \text{if } k \equiv 1(\text{mod}2); \\ \frac{n(n-2)}{2k}, & \text{if } k \equiv 0(\text{mod}2), \end{cases}$$

and

$$|\Phi(g)| = 2^{\alpha(n,k)}(n-2)!^{\frac{n}{k}}, \quad (4.3)$$

Similarly, if $k \equiv 0(\text{mod}2)$, we get also that

$$|\Phi(g\alpha)| = 2^{\alpha(n,k)}(n-2)!^{\frac{n}{k}} \quad (4.4)$$

for an chosen element $g, g \in \mathcal{E}_{[k\frac{n}{k}]}$.

Now for $\forall h \in \mathcal{E}_{[1,k\frac{n-1}{k}]}$, without loss of generality, we assume that $h = (1, 2, \dots, k)(k+1, k+2, \dots, 2k) \dots ((\frac{n-1}{k}-1)k+1, (\frac{n-1}{k}-1)k+2, \dots, (n-1))(n)$. Then the above statement is also true for the complete graph K_{n-1} with the vertices $1, 2, \dots, n-1$. Notice that the quadricells $n^{1+}, n^{2+}, \dots, n^{n-1+}$ can be chosen first in our enumeration and they are not belong to the graph K_{n-1} . According to Lemma 4.2, we get that

$$|\Phi(h)| = 2^{\beta(n,k)}(n-2)!^{\frac{n-1}{k}} \times \frac{2\phi(k)(n-2)!}{|\mathcal{E}_{[1,k\frac{n-1}{k}]}|}, \quad (4.5)$$

Where

$$\beta(n, k) = h(\varepsilon) = \begin{cases} \frac{\varepsilon(K_{n-1})}{k} - \frac{n-1}{k} = \frac{(n-1)(n-4)}{2k}, & \text{if } k \equiv 1(\text{mod}2); \\ \frac{\varepsilon(K_{n-1})}{k} - \frac{n-1}{k} = \frac{(n-1)(n-3)}{2k}, & \text{if } k \equiv 0(\text{mod}2). \end{cases}$$

Combining (4.3) – (4.5), we get that

$$n^L(K_n) = \frac{1}{2n!} \times \left(\sum_{k|n} |\mathcal{E}_{[k\frac{n}{k}]}| |\Phi(g_0)| + \sum_{l|n, l \equiv 0(\text{mod}2)} |\mathcal{E}_{[l\frac{n}{l}]}| |\Phi(g_1\alpha)| \right)$$

$$\begin{aligned}
 & + \sum_{l|(n-1)} |\mathcal{E}_{[1,l^{\frac{n-1}{l}}]}| |\Phi(h)| \\
 & = \frac{1}{2n!} \times \left(\sum_{k|n} \frac{n! 2^{\alpha(n,k)} (n-2)!^{\frac{n}{k}}}{k^{\frac{n}{k}} \left(\frac{n}{k}\right)!} + \sum_{k|n, k \equiv 0 \pmod{2}} \frac{n! 2^{\alpha(n,k)} (n-2)!^{\frac{n}{k}}}{k^{\frac{n}{k}} \left(\frac{n}{k}\right)!} \right) \\
 & + \sum_{k|(n-1), k \neq 1} \frac{n!}{k^{\frac{n-1}{k}} \left(\frac{n-1}{k}\right)!} \times \frac{2\phi(k)(n-2)! 2^{\beta(n,k)} (n-2)!^{\frac{n-1}{k}}}{\frac{(n-1)!}{k^{\frac{n-1}{k}} \left(\frac{n-1}{k}\right)!}} \\
 & = \frac{1}{2} \left(\sum_{k|n} + \sum_{k|n, k \equiv 0 \pmod{2}} \right) \frac{2^{\alpha(n,k)} (n-2)!^{\frac{n}{k}}}{k^{\frac{n}{k}} \left(\frac{n}{k}\right)!} + \sum_{k|(n-1), k \neq 1} \frac{\phi(k) 2^{\beta(n,k)} (n-2)!^{\frac{n-1}{k}}}{n-1}.
 \end{aligned}$$

For $n = 4$, similar calculation shows that $n^L(K_4) = 11$ by consider the fixing set of permutations in $\mathcal{E}_{[s^{\frac{4}{s}}]}$, $\mathcal{E}_{[1, s^{\frac{3}{s}}]}$, $\mathcal{E}_{[(2s)^{\frac{4}{2s}}]}$, $\alpha\mathcal{E}_{[(2s)^{\frac{4}{2s}}]}$ and $\alpha\mathcal{E}_{[1,1,2]}$. \spadesuit

For orientable complete maps, we get the number $n^O(K_n)$ of orientable complete maps of order n as follows.

Theorem 4.2 *The number $n^O(K_n)$ of complete maps of order $n \geq 5$ on orientable surfaces is*

$$n^O(K_n) = \frac{1}{2} \left(\sum_{k|n} + \sum_{k|n, k \equiv 0 \pmod{2}} \right) \frac{(n-2)!^{\frac{n}{k}}}{k^{\frac{n}{k}} \left(\frac{n}{k}\right)!} + \sum_{k|(n-1), k \neq 1} \frac{\phi(k)(n-2)!^{\frac{n-1}{k}}}{n-1}.$$

and $n(K_4) = 3$.

Proof According to the Tutte's algebraic representation of maps, a map $M = (\mathcal{X}_{\alpha,\beta}, \mathcal{P})$ is orientable if and only if for $\forall x \in \mathcal{X}_{\alpha,\beta}$, x and $\alpha\beta x$ are in a same orbit of $\mathcal{X}_{\alpha,\beta}$ under the action of the group $\Psi_I = \langle \alpha\beta, \mathcal{P} \rangle$. Now applying (2.1) in Corollary 2.1 and Theorem 3.1, similar to the proof of Theorem 4.1, we get the number $n^O(K_n)$ for $n \geq 5$ as follows

$$n^O(K_n) = \frac{1}{2} \left(\sum_{k|n} + \sum_{k|n, k \equiv 0 \pmod{2}} \right) \frac{(n-2)!^{\frac{n}{k}}}{k^{\frac{n}{k}} \left(\frac{n}{k}\right)!} + \sum_{k|(n-1), k \neq 1} \frac{\phi(k)(n-2)!^{\frac{n-1}{k}}}{n-1}.$$

and for the complete graph K_4 , calculation shows that $n(K_4) = 3$. \spadesuit

Notice that $n^O(K_n) + n^N(K_n) = n^L(K_n)$. Therefore, we can also get the number $n^N(K_n)$ of unrooted complete maps of order n on non-orientable surfaces by Theorem 4.1 and Theorem 4.2.

Theorem 4.3 The number $n^N(K_n)$ of unrooted complete maps of order $n, n \geq 5$ on non-orientable surfaces is

$$n^N(K_n) = \frac{1}{2} \left(\sum_{k|n} + \sum_{k|n, k \equiv 0 \pmod{2}} \right) \frac{(2^{\alpha(n,k)} - 1)(n-2)! \frac{n}{k}}{k^{\frac{n}{k}} \left(\frac{n}{k}\right)!} + \sum_{k|(n-1), k \neq 1} \frac{\phi(k)(2^{\beta(n,k)} - 1)(n-2)! \frac{n-1}{k}}{n-1},$$

and $n^N(K_4) = 8$. Where, $\alpha(n, k)$ and $\beta(n, k)$ are same as in Theorem 4.1.

For $n = 5$, calculation shows that $n^L(K_5) = 1080$ and $n^O(K_5) = 45$ based on Theorem 4.1 and 4.2. For $n = 4$, there are 3 unrooted orientable maps and 8 non-orientable maps shown in the Fig.2.

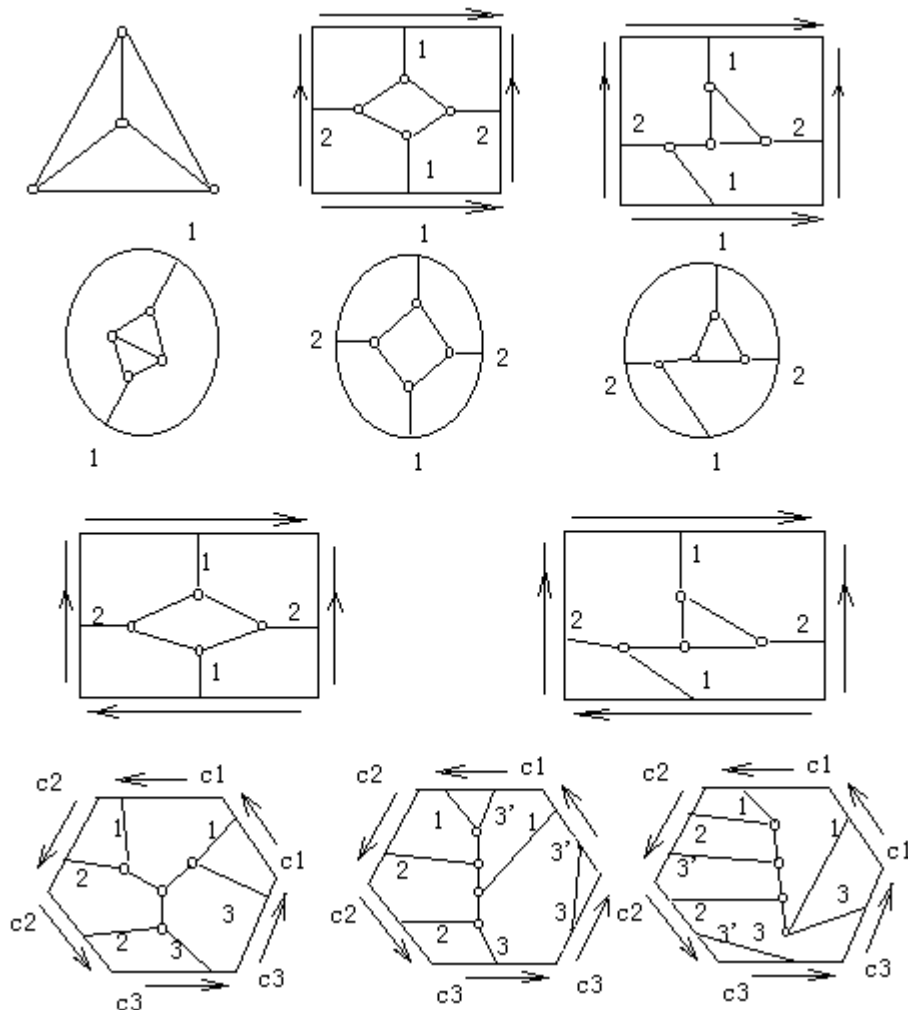

Fig.2

All the 11 maps of K_4 on surfaces are non-isomorphic.

Noticing that for an orientable map M , its cyclic order-preserving automorphisms are just the orientation-preserving automorphisms of map M by definition. Now consider the action of cyclic order-preserving automorphisms of complete maps, determined in Theorem 3.2 on all orientable embeddings of a complete graph of order n . Similar to the proof of Theorem 4.2, we can get the number of non-equivalent embeddings of complete graph of order n , which is same as the result of Mull et al. in [15].

References

- [1] N.L.Biggs, Automorphisms of imbedded graphs, *J. Combinatorial Theory* 11,132-138(1971).
- [2] N.L.Biggs and A.T.White, *Permutation Groups and Combinatoric Structure*, Cambridge University Press (1979).
- [3] E.Bujalance, Automorphism groups of compact planar Klein surfaces, *Manuscripta Math*,56,105-124(1986).
- [4] E.Bujalance, Cyclic groups of automorphisms of compact non-orientable Klein surfaces without boundary, *Pacific J. Math*, vol.109,No.2,279-289(1983).
- [5] Edmonds.J, A combinatorial representation for polyhedral surfaces, *Notices Amer. Math. Soc* 7 (1960)
- [6] W.J.Harvey, Cyclic groups of automorphisms of a compact Riemann surface, *Quart. J.Math.Oxford* (2),17,86-97(1966).
- [7] Jin Ho Kwak and Jaeun Lee, Enumeration of graph embeddings, *Discrete Math*, 135(1994), 129 151.
- [8] L.F.Mao and Y.P.Liu , On the roots on orientable embeddings of graph, *Acta Math. Scienta Ser.A*,vol.23, No.3,287-293(2003).
- [9] L.F.Mao and Y.P.Liu, Group action for enumerating maps on surfaces, *J.Appl. Math. & Computing*,vol.13,No.1-2,201-215(2003).
- [10] L.F.Mao and Y.P.Liu, New approach for enumerating maps on orientable surface, *Australasian J. Combinatoric* (accepted).
- [11] L.F.Mao, Y.P.Liu and F. Tian, Automorphisms of maps with given underlying graph and its application to enumeration, *Acta Math. Sinica*, vol.21,

- No.2(2005), 225-236.
- [12] V.A.Liskovets, Enumeration of non-isomorphic planar maps, *Sel.Math.Sov.*, 4;4 (1985), 303 323.
 - [13] V.A.Liskovets, A reductive technique for Enumerating non-isomorphic planar maps, *Discrete Math*, 156(1996), 197 217.
 - [14] V.A.Liskovets and T.R.S.Walsh, The enumeration of non-isomorphic 2-connected planar maps, *Canad.J.Math.*, 35(1983), 417 435.
 - [15] B.P.Mull, R.G.Rieper and A.T.White, Enumeration 2-cell imbeddings of connected graphs, *Proc.Amer.Math.Soc.*, 103(1988), 321 330.
 - [16] B.P.Mull, Enumerating the orientable 2-cell imbeddings of complete bipartite graphs, *J.Graph Theory*, vol 30, 2(1999), 77-90.
 - [17] K. Nakagama, On the order of automorphisms of a closed Riemann surface, *Pacific J. Math.*, vol.115, No.2, 435-443(1984)
 - [18] S.Negami, Enumeration of projective -planar embeddings of graphs, *Discrete Math*, 62(1986), 299 306.
 - [19] W.T.Tutte, What is a maps? in *New Directions in the Theory of Graphs* (ed.by F.Harary), Academic Press (1973), 309 325.
 - [20] A.T.White, *Graphs of Group on Surfaces- interactions and models*, Elsevier Science B.V. (2001).
 - [21] Yanpei Liu, *Enumerative Theory of Maps*, Kluwer Academic Publisher, Dordrecht / Boston / London (1999).

21math-001-008



Automorphisms and Enumeration of Maps of Cayley Graphs of a Finite Group*

Linfan Mao

(Chinese Academy of Mathematics and System Science, Beijing 100080, P.R.China)

Yanpei Liu

(Institute of Applied Mathematics, Beijing Jiaotong University, Beijing,100044, P.R.China)

Abstract: A map is a connected topological graph Γ cellularly embedded in a surface. In this paper, applying Tutte's algebraic representation of map, new ideas for enumerating non-equivalent orientable or non-orientable maps of graph are presented. By determining automorphisms of maps of Cayley graph $\Gamma = \text{Cay}(G : S)$ with $\text{Aut}\Gamma \cong G \times H$ on locally orientable, orientable and non-orientable surfaces, formulae for the number of non-equivalent maps of Γ on surfaces (orientable, non-orientable or locally orientable) are obtained. Meanwhile, using results on GRR graph for finite groups, we enumerate the non-equivalent maps of GRR graph of symmetric groups, groups generated by 3 involutions and abelian groups on orientable or non-orientable surfaces.

基础图为有限群上的 Cayley 图的地图自同构及其计数

摘要. 一个地图是一个连通图在曲面上的 2-胞腔嵌入。应用 Tutte 提出的地图的代数表示方法，本文提出了计数图在可定向曲面上与不可定向曲面上不等价嵌入的计算方法。通过确定基础图为 Cayley 图 $\Gamma = \text{Cay}(G : S)$ ，这里 $\text{Aut}\Gamma \cong G \times H$ 的地图自同构，本文得到了计算 Γ 在可定向与不可定向曲面上不等价嵌入的计算公式。同时，利用有限群的 GRR 表

¹Finished in Nov.,2001, e-print: *arXiv: math.GM/0607791*

示的已知结果, 我们具体计数了基础图为对称群、3 个卷积元生成的群和交换群的 GRR 图的可定向、不可定向的不等价嵌入。

Key words: embedding, map, finite group, Cayley graph, graphical regular representation, automorphism group, Burnside Lemma.

Classification: AMS(1991) 05C10,05C25,05C30

1. Introduction

Maps originate from the decomposition of surfaces. A typical example in this field is the *Heawood map coloring theorem*. Combinatorially, a *map* is a connected topological graph Γ cellularly embedded in a surface. Motivated by the *four color problem*, the enumeration of maps on surfaces, especially, the planar rooted maps, has been intensively investigated by many researchers after the Tutte's pioneer work in 1962 (see [10]). By using the automorphisms of the sphere, Liskovets gives an enumerative scheme for unrooted planar maps^[8]. Liskovets, Walsh and Liskovets got many enumeration results for *general planar maps*, *regular planar maps*, *Eulerian planar maps*, *self-dual planar maps* and *2-connected planar maps*, etc^{[7]–[9]}. Applying the well-known Burnside Lemma in permutation groups and the Edmonds embedding scheme^[2], Biggs and White presented a formula for enumerating the non-equivalent maps (also a kind of unrooted maps) of a graph on orientable surfaces(see [1],[14],[19]), which has been successfully used for the complete graphs, wheels and complete bipartite graphs by determining the fix set $F_v(\alpha)$ for each vertex v and automorphism α of a graph^{[14]–[15],[19]}.

Notice that Biggs and White's formula can be only used for orientable surfaces. For counting non-orientable maps of graphs, new mechanism should be devised. In 1973, Tutte presented an algebraic representation for maps on locally orientable surface^([10],[17]–[18]). Applying the Tutte's map representation, a general scheme for enumerating the non-equivalent maps of a graph on surfaces can be established (Lemma 3.1 in section 3), which can be used for orientable or non-orientable surfaces. This enumeration scheme has been used to enumerate complete maps on surfaces (orientable, non-orientable or locally orientable) by determining all orientation-preserving automorphisms of maps of a complete graph^[13]. In orientable case, result is the same as in [14]. The approach of counting orbits under the action of a

permutation group is also used to enumerate the rooted maps and non-congruent embeddings of a graph^{[6],[11],[16]}. Notice that an algebraic approach for construction non-hamiltonian cubic maps on every surface is presented in [12]. The main purpose of this paper is to enumerate the non-equivalent maps of Cayley graph Γ of a finite group G satisfying $\text{Aut}\Gamma = R(G) \times H \cong G \times H$ on orientable, non-orientable or locally orientable surfaces, where H is a subgroup of $\text{Aut}\Gamma$. For this objective, we get all orientation-preserving automorphisms of maps of Γ in the Section 2. The scheme for enumerating non-equivalent maps of a graph is re-established in Section 3. Using this scheme, results for non-equivalent maps of Cayley graphs are obtained. For concrete examples, in Section 4, we calculate the numbers of non-equivalent maps of GRR graphs for symmetric groups, groups generated by 3 involutions and abelian groups. Terminologies and notations used in this paper are standard. Some of them are mentioned in the following.

All surfaces are 2-dimensional compact closed manifolds without boundary, graphs are connected and groups are finite in the context.

For a finite group G , choose a subset $S \subset G$ such that $S^{-1} = S$ and $1_G \notin S$, the Cayley graph $\Gamma = \text{Cay}(G : S)$ of G with respect to S is defined as follows:

$$V(\Gamma) = G;$$

$$E(\Gamma) = \{(g, sg) | g \in G, s \in S\}.$$

It has been shown that Γ is transitive, the right regular representation $R(G)$ is a subgroup of $\text{Aut}\Gamma$ and it is connected if and only if $G = \langle S \rangle$. If there exists a *Cayley set* S such that $\text{Aut}(\text{Cay}(G : S)) = R(G) \cong G$, then G is called to have a *graphical regular representation*, abbreviated to GRR and say $\text{Cay}(G : S)$ is the GRR graph of the finite group G . Notice that which groups have GRR are completely determined (see [4] – [5] and [21] for details).

A *map* $M = (\mathcal{X}_{\alpha,\beta}, \mathcal{P})$ is defined] to be a permutation \mathcal{P} acting on $\mathcal{X}_{\alpha,\beta}$ of a disjoint union of quadricells Kx of $x \in \mathcal{X}$, where $K = \{1, \alpha, \beta, \alpha\beta\}$ is the Klein group, satisfying the following conditions:

- (i) for $\forall x \in \mathcal{X}_{\alpha,\beta}$, there does not exist an integer k such that $\mathcal{P}^k x = \alpha x$;
- (ii) $\alpha\mathcal{P} = \mathcal{P}^{-1}\alpha$;
- (iii) the group $\Psi_J = \langle \alpha, \beta, \mathcal{P} \rangle$ is transitive on $\mathcal{X}_{\alpha,\beta}$.

According to the condition (ii), the vertices of a map are defined to be the pairs of conjugate of \mathcal{P} action on $\mathcal{X}_{\alpha,\beta}$ and edges the orbits of K on $\mathcal{X}_{\alpha,\beta}$. For

example, $\{x, \alpha x, \beta x, \alpha\beta x\}$ is an edge for $\forall x \in \mathcal{X}_{\alpha, \beta}$ of M . Geometrically, any map M is an embedding of a graph Γ on a surface (see also [10], [17] – [18]), denoted by $M = M(\Gamma)$ and $\Gamma = \Gamma(M)$. The graph Γ is called the underlying graph. If $r \in \mathcal{X}_{\alpha, \beta}$ is marked beforehand, then M is called a *rooted map*, denoted by M^r .

For example, the graph K_4 on the tours with one face length 4 and another 8 shown in Fig. 1,

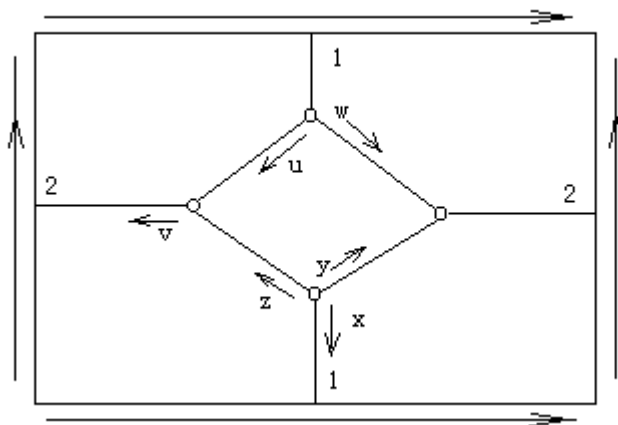

Fig.1

can be algebraically represented as follows:

A map $(\mathcal{X}_{\alpha, \beta}, \mathcal{P})$ with $\mathcal{X}_{\alpha, \beta} = \{x, y, z, u, v, w, \alpha x, \alpha y, \alpha z, \alpha u, \alpha v, \alpha w, \beta x, \beta y, \beta z, \beta u, \beta v, \beta w, \alpha\beta x, \alpha\beta y, \alpha\beta z, \alpha\beta u, \alpha\beta v, \alpha\beta w\}$ and

$$\begin{aligned} \mathcal{P} &= (x, y, z)(\alpha\beta x, u, w)(\alpha\beta z, \alpha\beta u, v)(\alpha\beta y, \alpha\beta v, \alpha\beta w) \\ &\times (\alpha x, \alpha z, \alpha y)(\beta x, \alpha w, \alpha u)(\beta z, \alpha v, \beta u)(\beta y, \beta w, \beta v) \end{aligned}$$

The four vertices of this map are $\{(x, y, z), (\alpha x, \alpha z, \alpha y)\}$, $\{(\alpha\beta x, u, w), (\beta x, \alpha w, \alpha u)\}$, $\{(\alpha\beta z, \alpha\beta u, v), (\beta z, \alpha v, \beta u)\}$ and $\{(\alpha\beta y, \alpha\beta v, \alpha\beta w), (\beta y, \beta w, \beta v)\}$ and six edges are $\{e, \alpha e, \beta e, \alpha\beta e\}$ for $\forall e \in \{x, y, z, u, v, w\}$.

Two maps $M_1 = (\mathcal{X}_{\alpha, \beta}^1, \mathcal{P}_1)$ and $M_2 = (\mathcal{X}_{\alpha, \beta}^2, \mathcal{P}_2)$ are called to be *isomorphic* if there exists a bijection $\tau : \mathcal{X}_{\alpha, \beta}^1 \longrightarrow \mathcal{X}_{\alpha, \beta}^2$ such that for $\forall x \in \mathcal{X}_{\alpha, \beta}^1, \tau\alpha(x) = \alpha\tau(x)$, $\tau\beta(x) = \beta\tau(x)$ and $\tau\mathcal{P}_1(x) = \mathcal{P}_2\tau(x)$ and τ is called an *isomorphism* between them. Similarly, two maps M_1, M_2 are called to be *equivalent* if there exists an isomorphism ξ between M_1 and M_2 such that for $\forall x \in \mathcal{X}_{\alpha, \beta}^1, \tau\mathcal{P}_1(x) \neq \mathcal{P}_2^{-1}\tau(x)$.

Call ξ an *equivalence* between M_1 and M_2 . If $M_1 = M_2 = M$, then an isomorphism or an equivalence between M_1 and M_2 is called an automorphism or an orientation-preserving automorphism of M . Certainly, an orientation-preserving automorphism of a map is an automorphism of map preserving the orientation on this map.

All automorphisms or orientation-preserving automorphisms of a map M form groups, called *automorphism group* or *orientation-preserving automorphism group* of M and denoted by $\text{Aut}M$ or $\text{Aut}_O M$, respectively. Similarly, two rooted maps M_1^r and M_2^r are said to be *isomorphic* if there is an isomorphism θ between them such that $\theta(r_1) = r_2$, where r_1, r_2 are the roots of M_1^r and M_2^r , respectively and denote the *automorphism group* of M^r by $\text{Aut}M^r$. It has been known that $\text{Aut}M^r$ is the trivial group.

Now let Γ be a connected graph. The notations $\mathcal{E}^O(\Gamma), \mathcal{E}^N(\Gamma)$ and $\mathcal{E}^L(\Gamma)$ denote the embeddings of Γ on the orientable surfaces, non-orientable surfaces and locally orientable surfaces, $\mathcal{M}(\Gamma)$ and $\text{Aut}\Gamma$ denote the set of non-isomorphic maps underlying a graph Γ and its automorphism group, respectively.

Terminologies and notations not defined here can be seen in [10] for maps and graphs and in [1] and [20] for groups.

Notice that the *equivalence* and *isomorphism* for maps are two different concepts, for example, map $M = (\mathcal{X}_{\alpha,\beta}, \mathcal{P})$ is always isomorphic to its mirror map $M^{-1} = (\mathcal{X}_{\alpha,\beta}, \mathcal{P}^{-1})$, but M_1 must not be equivalent to its mirror M^{-1} . We establish an approach for calculating non-equivalent maps underlying a graph and concrete results in the sequel sections.

2. Determining orientation-preserving automorphisms of maps of Cayley graphs

For $C = \{(x_1, x_2, \dots, x_l), (\alpha x_l, \alpha x_{l-1}, \dots, \alpha x_1)\}$, the permutation $\Theta = (x_1, x_2, \dots, x_l)(\alpha x_l, \alpha x_{l-1}, \dots, \alpha x_1)$ is called a pair permutation. Denote by $\{C\}$ the set $\{x_1, x_2, \dots, x_l, \alpha x_1, \alpha x_2, \dots, \alpha x_l\}$ and $g|_{\Omega_1}$ the constraint of permutation g action on Ω_1 for $\Omega_1 \subset \Omega$. Then we get the following result.

Lemma 2.1 *Let Γ be a connected graph. Then*

- (i) *For any map $M \in \mathcal{M}(\Gamma)$, if $\tau \in \text{Aut}M$, then $\tau|_{V(\Gamma)} \in \text{Aut}\Gamma$;*
- (ii) *For any two maps M_1, M_2 underlying the graph Γ , if θ is an isomorphism*

mapping M_1 to M_2 , then $\theta|_{V(\Gamma)} \in \text{Aut}\Gamma$.

Proof According to the Tutte's algebraic representation for maps, we can assume that $M = (\mathcal{X}_{\alpha,\beta}, \mathcal{P})$ with $\mathcal{X} = E(\Gamma)$. For $\forall x, y \in V(M)$, we know that

$$x = \{(e_1, e_2, \dots, e_s), (\alpha e_s, \alpha e_{s-1}, \dots, \alpha e_1)\};$$

$$y = \{(e^1, e^2, \dots, e^t), (\alpha e^t, \alpha e^{t-1}, \dots, \alpha e^1)\}.$$

Now if $e = xy \in E(G)$, there must be two integers i, j , such that $e_i = \beta e^j = e$ or $\beta e_i = e_j = e$. Whence, we get that

(i) if $\tau \in \text{Aut}M$, then $V(\Gamma) = V(M) = V^\tau(M) = V^\tau(\Gamma)$ and

$$x^\tau = \{(\tau(e_1), \tau(e_2), \dots, \tau(e_s)), (\alpha\tau(e_s), \alpha\tau(e_{s-1}), \dots, \alpha\tau(e_1))\};$$

$$y^\tau = \{(\tau(e^1), \tau(e^2), \dots, \tau(e^t)), (\alpha\tau(e^t), \alpha\tau(e^{t-1}), \dots, \alpha\tau(e^1))\}.$$

Therefore,

$$e^\tau \in \{x^\tau\} \cap \beta\{y^\tau\} \quad \text{or} \quad e^\tau \in \beta\{x^\tau\} \cap \{y^\tau\}.$$

Whence, $x^\tau y^\tau \in E(\Gamma)$ and $\tau|_{V(\Gamma)} \in \text{Aut}\Gamma$.

(ii) Similarly, if $\theta : M_1 \longrightarrow M_2$ is an isomorphism, then $\theta : V(\Gamma) = V(M_1) \longrightarrow V(M_2) = V(\Gamma)$ and

$$e^\theta \in \{x^\theta\} \cap \beta\{y^\theta\} \quad \text{or} \quad e^\theta \in \beta\{x^\theta\} \cap \{y^\theta\}$$

Whence we get that

$$e^\theta = x^\theta y^\theta \in E(\Gamma) \quad \text{and} \quad \theta|_{V(\Gamma)} \in \text{Aut}\Gamma. \quad \square$$

Lemma 2.2 For $\forall g \in \text{Aut}M, \forall x \in \mathcal{X}_{\alpha,\beta}$ of a map M ,

$$(i) \quad |x^{\text{Aut}M}| = |\text{Aut}M|;$$

$$(ii) \quad |x^{\langle g \rangle}| = o(g),$$

where, $o(g)$ denotes the order of g .

Proof For any subgroup $H \prec \text{Aut}M$, we know that $|H| = |x^H||H_x|$. Since $H_x \prec \text{Aut}M^x$ by definition, where M^x is the rooted map with root x , and $\text{Aut}M^x$ is trivial, we know that $|H_x| = 1$. Whence, $|x^H| = |H|$. Now take $H = \text{Aut}M$ or $\langle g \rangle$, we get the assertions (i) and (ii). \spadesuit

For $\forall g \in \text{Aut}\Gamma$, $M = (\mathcal{X}_{\alpha,\beta}, \mathcal{P}) \in \mathcal{M}(\Gamma)$, define an extending action of g on M by

$$g^* = g \upharpoonright^{\mathcal{X}_{\alpha,\beta}}: \mathcal{X}_{\alpha,\beta} \longrightarrow \mathcal{X}_{\alpha,\beta},$$

such that $M^{g^*} = gMg^{-1}$ and $g\alpha = \alpha g, g\beta = \beta g$. A permutation p on set Ω is called semi-regular if all of its orbits have the same length. Whence, an automorphism of a map is semi-regular. The next result is followed by Lemma 2.1 and the definition of extending action of elements in $\text{Aut}\Gamma$ gives a necessary and sufficient condition for an automorphism of a map to be an orientation-preserving automorphism of this map.

Theorem 2.1 *For a connected graph Γ , an automorphism ξ^* of map M is an orientation-preserving automorphism of map underlying Γ if and only if there exists an element $\xi \in \text{Aut}\Gamma$ such that $\xi^* = \xi \upharpoonright^{\mathcal{X}_{\alpha,\beta}}$.*

Now for a finite group G , let $\Gamma = \text{Cay}(G : S)$ be a connected Cayley graph respect to S . Then its edge set is $\{(g, sg) | \forall g \in G, \forall s \in S\}$. For convenience, we use g^{sg} denoting an edge (g, sg) in the Cayley graph $\text{Cay}(G : S)$. Then its quadricell of this edge can be represented by $\{g^{sg+}, g^{sg-}, (sg)^{g+}, (sg)^{g-}\}$ and

$$\mathcal{X}_{\alpha,\beta}(\Gamma) = \{g^{sg+} | \forall g \in G, \forall s \in S\} \cup \{g^{sg-} | \forall g \in G, \forall s \in S\};$$

$$\alpha = \prod_{g \in G, s \in S} (g^{sg+}, g^{sg-});$$

$$\beta = \prod_{g \in G, s \in S} (g^{sg+}, (sg)^{g+})(g^{sg-}, (sg)^{g-}).$$

The main result of this section is the following.

Theorem 2.2 *Let $\Gamma = \text{Cay}(G : S)$ be a connected Cayley graph with $\text{Aut}\Gamma = R(G) \times H$. Then for $\forall \theta \in \text{Aut}\Gamma$, the extending action $\theta \upharpoonright^{\mathcal{X}_{\alpha,\beta}}$ is an orientation-preserving automorphism of a map in $\mathcal{E}(\Gamma)$ on surfaces.*

Proof The proof is divided into two parts. First, we prove each automorphism of the graph Γ is semi-regular and second, construct a stable embedding of Γ for $\forall \theta \in \text{Aut}\Gamma$.

(i) For $\forall g \in \text{Aut}\Gamma$, since $\text{Aut}\Gamma = R(G) \times H$, there must exist $\gamma \in R(G), \delta \in H$ such that $g = \gamma\delta = \delta\gamma$. Now for $\forall x \in G$, the action of elements in $\langle g \rangle$ on x are as follows.

$$\begin{aligned} x^g &= (x^\delta)^\gamma = x^\delta \gamma; \\ x^{g^2} &= (x^{\delta^2})^{\gamma^2} = x^{\delta^2} \gamma^2; \\ &\dots\dots\dots; \\ x^{g^n} &= (x^{\delta^n})^{\gamma^n} = x^{\delta^n} \gamma^n; \\ &\dots\dots\dots. \end{aligned}$$

Therefore, the orbit of $\langle g \rangle$ acting on x is

$$x^{\langle g \rangle} = (x, x^\delta \gamma, x^{\delta^2} \gamma^2, \dots, x^{\delta^n} \gamma^n, \dots).$$

That is, for $\forall x \in G, |x^{\langle g \rangle}| = [o(\delta), o(\gamma)]$. Whence, g is semi-regular.

(ii) Assume that the automorphism θ of Γ is

$$\theta = (a, b, \dots, c) \cdots (g, h, \dots, k) \cdots (x, y, \dots, z),$$

where the length of each cycle is $\kappa = o(g), G = \{a, b, \dots, c, \dots, g, h, \dots, k, \dots, x, y, \dots, z\}$ and $S = \{s_1, s_2, \dots, s_t\} \subset G$. Denote by $T = \{a, \dots, g, \dots, x\}$ the representation set of each cycle in θ . We construct a map $M = (\mathcal{X}_{\alpha, \beta}, \mathcal{P})$ underlying Γ with

$$\mathcal{X}_{\alpha, \beta}(\Gamma) = \{g^{sg^+} | \forall g \in G, \forall s \in S\} \cup \{g^{sg^-} | \forall g \in G, \forall s \in S\};$$

$$\mathcal{P} = \prod_{g \in T} \prod_{x \in C(g)} (C_x)(\alpha C_x^{-1} \alpha^{-1}),$$

where $C(g)$ denotes the cycle containing g and let $x = \theta^f(g)$, then

$$C_x = (\theta^f(g)^{\theta^f(s_1g^+)}, \theta^f(g)^{\theta^f(s_2g^+)}, \dots, \theta^f(g)^{\theta^f(s_tg^+)})$$

and

$$\alpha C_x^{-1} \alpha^{-1} = (\alpha \theta^f(g)^{\theta^f(s_t g^-)}, \alpha \theta^f(g)^{\theta^f(s_{t-1} g^-)}, \dots, \alpha \theta^f(g)^{\theta^f(s_1 g^-)}).$$

It is clear that $M = \theta M \theta^{-1}$. According to Theorem 2.1, we know that $\theta |^{\mathcal{X}_{\alpha,\beta}}$ is an orientation-preserving automorphism of map M .

Combining (i) with (ii), the proof is complete. \square

According to the *Rotation Embedding Scheme* for orientable embeddings of a graph formalized by Edmonds in [2], each orientable complete map is just the case of eliminating the signs “+,-” in our representation of maps. Whence, we get the following result for orientable maps underlying a Cayley graph of a finite group.

Theorem 2.3 *Let $\Gamma = \text{Cay}(G : S)$ be a connected Cayley graph with $\text{Aut}\Gamma = R(G) \times H$. Then for $\forall \theta \in \text{Aut}\Gamma$, the extending action $\theta |^{\mathcal{X}_{\alpha,\beta}}$ is an orientation-preserving automorphism of a map in $\mathcal{M}(\Gamma)$ on orientable surfaces.*

Notices that a GRR graph Γ of a finite group G satisfies $\text{Aut}\Gamma = R(G)$. Since $R(G) \cong R(G) \times \{1_{\text{Aut}\Gamma}\}$, by Theorems 2.2 and 2.3, we get all orientation-preserving automorphisms of maps of GRR graphs of a finite group as follows.

Corollary 2.1 *Let $\Gamma = \text{Cay}(G : S)$ be a connected GRR graph of a finite group G . Then for $\forall \theta \in \text{Aut}\Gamma$, the extending action $\theta |^{\mathcal{X}_{\alpha,\beta}}$ is an orientation-preserving automorphism of a map in $\mathcal{M}(\Gamma)$ on locally orientable surfaces.*

Corollary 2.2 *Let $\Gamma = \text{Cay}(G : S)$ be a connected GRR of a finite group G . Then for $\forall \theta \in \text{Aut}\Gamma$, the extending action $\theta |^{\mathcal{X}_{\alpha,\beta}}$ is an orientation-preserving automorphism of a map in $\mathcal{M}(\Gamma)$ on orientable surfaces.*

3. The enumeration of non-equivalent maps of Cayley graphs

According to Theorem 2.1, we can get a general scheme for enumerating the non-equivalent maps of a graph Γ on surfaces.

Lemma 3.1 *For any connected graph Γ , let $\mathcal{E} \subset \mathcal{E}^L(\Gamma)$, then the number $n(\mathcal{E}, \mathcal{M})$ of non-equivalent maps in \mathcal{E} is*

$$n(\mathcal{E}, \mathcal{M}) = \frac{1}{|\text{Aut}\Gamma|} \sum_{g \in \text{Aut}\Gamma} |\Phi(g)|,$$

where, $\Phi(g) = \{\mathcal{P} | \mathcal{P} \in \mathcal{E} \text{ and } \mathcal{P}^g = \mathcal{P}\}$.

Proof According to Theorem 2.1, two maps $M_1, M_2 \in \mathcal{E}$ are equivalent if and only if there exists an automorphism $g \in \text{Aut}\Gamma$ such that $M_1^{g^*} = M_2$, where, $g^* = g |^{\mathcal{X}_{\alpha,\beta}}$. Whence, all non-equivalent maps in \mathcal{E} are just the representations of the orbits in \mathcal{E} under the action of $\text{Aut}\Gamma$. By the Burnside Lemma, the number of non-equivalent maps in \mathcal{E} is

$$n(\mathcal{E}, \mathcal{M}) = \frac{1}{|\text{Aut}\Gamma|} \sum_{g \in \text{Aut}\Gamma} |\Phi(g)|. \quad \spadesuit$$

Corollary 3.1 *The numbers of non-equivalent maps in $\mathcal{E}^O(\Gamma)$, $\mathcal{E}^N(\Gamma)$ and $\mathcal{E}^L(\Gamma)$ are*

$$n(\mathcal{E}^O(\Gamma), \mathcal{M}) = \frac{1}{|\text{Aut}\Gamma|} \sum_{g \in \text{Aut}\Gamma} |\Phi^O(g)|; \quad (3.1)$$

$$n(\mathcal{E}^N(\Gamma), \mathcal{M}) = \frac{1}{|\text{Aut}\Gamma|} \sum_{g \in \text{Aut}\Gamma} |\Phi^N(g)|; \quad (3.2)$$

$$n(\mathcal{E}^L(\Gamma), \mathcal{M}) = \frac{1}{|\text{Aut}\Gamma|} \sum_{g \in \text{Aut}\Gamma} |\Phi^L(g)|, \quad (3.3)$$

where, $\Phi^O(g) = \{\mathcal{P} | \mathcal{P} \in \mathcal{E}^O(\Gamma) \text{ and } \mathcal{P}^g = \mathcal{P}\}$, $\Phi^N(g) = \{\mathcal{P} | \mathcal{P} \in \mathcal{E}^N(\Gamma) \text{ and } \mathcal{P}^g = \mathcal{P}\}$, $\Phi^L(g) = \{\mathcal{P} | \mathcal{P} \in \mathcal{E}^L(\Gamma) \text{ and } \mathcal{P}^g = \mathcal{P}\}$.

Corollary 3.2 *In formula (3.1)-(3.3), $|\Phi(g)| \neq 0$ if, and only if g is an orientation-preserving automorphism of map of graph Γ on an orientable, non-orientable or locally orientable surface.*

The formula (3.1) is obtained by Biggs and White in [1]. Applying Theorems 2.2 – 2.3 and the formulae (3.1) – (3.3), we can enumerate the non-equivalent maps underlying a Cayley graph Γ of a finite group G satisfying $\text{Aut}\Gamma = R(G) \times H$ on orientable surfaces, non-orientable surfaces and locally orientable surfaces.

Theorem 3.1 *Let $\Gamma = \text{Cay}(G : S)$ be a connected Cayley graph with $\text{Aut}\Gamma = R(G) \times H$. Then the number $n_{\mathcal{M}}^T(G : S)$ of non-equivalent maps underlying Γ on locally orientable surfaces is*

$$n_{\mathcal{M}}^L(G : S) = \frac{1}{|G||H|} \sum_{\xi \in O_G} |\mathcal{E}_{\xi}| 2^{\alpha(S,\xi)} (|S| - 1)!^{\frac{|G|}{\sigma(\xi)}},$$

where O_G denotes the representation set of conjugate class of $\text{Aut}\Gamma$, \mathcal{E}_ξ the conjugate class in $\text{Aut}\Gamma$ containing ξ and

$$\alpha(S, \xi) = \begin{cases} \frac{|G||S|-2|G|}{2o(\xi)}, & \text{if } \xi \in \Theta \\ \frac{|G||S|+2l-2|G|}{2o(\xi)}, & \text{if } \xi \in \Delta. \end{cases}$$

where, $\Theta = \{\xi | o(\xi) \equiv 1 \pmod{2} \vee o(\xi) \equiv 0 \pmod{2}, \exists s \in S, t \in G \text{ such that } s = t^{\xi \frac{o(\xi)}{2}}\}$, $\Delta = \{\xi | o(\xi) \equiv 0 \pmod{2} \wedge \exists s_i \in S, t_i \in G, 1 \leq i \leq l(\xi), l(\xi) \equiv 0 \pmod{\frac{o(\xi)}{2}} \text{ such that } s_i = t_i^{\xi \frac{o(\xi)}{2}}\}$.

Proof Notice that $\Phi^L(\xi)$ is a class function on $\text{Aut}\Gamma$. According to Theorem 2.2 and Corollary 3.1, we know that

$$\begin{aligned} n_{\mathcal{M}}^L(G : S) &= \frac{1}{|\text{Aut}\Gamma|} \times \sum_{\xi \in \text{Aut}\Gamma} |\Phi^L(\xi)| \\ &= \frac{1}{|G||H|} \sum_{\xi \in R(G) \times H} |\Phi^L(g)|. \end{aligned} \quad (3.4)$$

Since for $\forall \xi = (\mu, \nu) \in \text{Aut}\Gamma$, ξ is semi-regular, without loss of generality, we can assume that

$$\xi = (a, b, \dots, c) \cdots (g, h, \dots, k) \cdots (x, y, \dots, z),$$

where the length of each cycle is $o(\xi) = [o(\mu), o(\nu)]$,

$$\mathcal{P} = \prod_{g \in T} \prod_{x \in C(g)} (C_x)(\alpha C_x^{-1}),$$

being a map underlying the graph Γ and stable under the action of ξ , $C(g)$ denotes the cycle containing g and T is the representation set of cycles in ξ . Let $S = \{s_1, s_2, \dots, s_k\}$ and $x = \xi^f(g)$, then

$$C_x = (\xi^f(g)^{\xi^f(s_1 g \nu_1)}, \xi^f(g)^{\xi^f(s_2 g \nu_2)}, \dots, \xi^f(g)^{\xi^f(s_t g \nu_k)}), \quad (3.5)$$

with $\nu_i \in \{+, -\}, 1 \leq i \leq k$.

Notice that the quadricell adjacent to the vertex a can make $2^{|S|-1}(|S|-1)!$ pair permutations, and for each chosen pair permutation, the pair permutations adjacent

to the vertex $x, x \in C(a)$ are uniquely determined by (3.5) since \mathcal{P} is stable under the action of ξ .

Similarly, for each given pair permutation adjacent to a vertex $u \in T$, the pair permutations adjacent to the vertices $v, v \in C(u)$ are also uniquely determined by (3.5) since \mathcal{P} is stable under the action of ξ .

Notice that any non-orientable embedding can be obtained by exchanging some x with $\alpha x, x \in \mathcal{X}_{\alpha, \beta}(M)$ in an orientable embedding M underlying Γ . Now for an orientable embedding M_1 of Γ , all the induced embeddings by exchanging some edge's two sides and retaining the others unchanged in M_1 are the same as M_1 by the definition of embedding. Therefore, the number of different stable maps under the action of ξ gotten by exchanging x and αx in M_1 for $x \in U, U \subset \mathcal{X}_\beta$, where $\mathcal{X}_\beta = \bigcup_{x \in E(\Gamma)} \{x, \beta x\}$, is $2^{\xi(\varepsilon) - \frac{|G|}{o(\xi)}}$, where $\xi(\varepsilon)$ is the number of orbits of $E(\Gamma)$ under the action of ξ , and we subtract $\frac{|G|}{o(\xi)}$ because we can choose $a^{b^+}, \dots, g^{a^+}, \dots, x^{a^+}$ first in our enumeration.

Since the length of each orbit under the action of ξ is $o(\xi)$ for $\forall e \in E(\Gamma)$ if $o(\xi) \equiv 1 \pmod{2}$ or $o(\xi) \equiv 0 \pmod{2}$ but there are not $s \in S, t \in G$ such that $s = t^\xi \frac{o(\xi)}{2}$ and is $\frac{o(\xi)}{2}$ for each edge $t_i^{s_i t_i}, 1 \leq i \leq l(\xi)$, if $o(\xi) \equiv 0 \pmod{2}$ and there are $s_i \in S, t_i \in G, 1 \leq i \leq l(\xi)$, such that $s_i = t_i^{\xi \frac{o(\xi)}{2}}$ (Notice that there must be $l \equiv 0 \pmod{\frac{o(\xi)}{2}}$) because ξ is an automorphism of the graph Γ or $o(\xi)$ for all other edges. Whence, we get that

$$\xi(\varepsilon) = \begin{cases} \frac{\varepsilon(\Gamma)}{o(\xi)}, & \text{if } \xi \in \Theta \\ \frac{\varepsilon(\Gamma) - l(\xi)}{o(\xi)} + \frac{2l(\xi)}{o(\xi)}, & \text{if } \xi \in \Delta. \end{cases}$$

Now for $\forall \pi \in \text{Aut}\Gamma$, since $\theta = \pi \xi \pi^{-1} \in \text{Aut}\Gamma$, we know that $\theta(\varepsilon) = \xi(\varepsilon)$. Therefore, we get that

$$\alpha(S, \xi) = \begin{cases} \frac{|G||S| - 2|G|}{2o(\xi)}, & \text{if } \xi \in \Theta \\ \frac{|G||S| + 2l(\xi) - 2|G|}{2o(\xi)}, & \text{if } \xi \in \Delta. \end{cases}$$

and

$$|\Phi^T(\xi)| = 2^{\alpha(S, \xi)} (|S| - 1)! \frac{|G|}{o(\xi)}. \quad (3.6)$$

Combining (3.4) with (3.6), we get that

$$n_{\mathcal{M}}^T(G : S) = \frac{1}{|G||H|} \sum_{\xi \in O_G} |\mathcal{E}_{\xi}| 2^{\alpha(S, \xi)} (|S| - 1)!^{\frac{|G|}{\sigma(\xi)}},$$

and the proof is complete. \spadesuit

According to the formula (3.1) and Theorem 2.3, we also get the number $n_{\mathcal{M}}^O(G : S)$ of non-equivalent maps of a Cayley graph $\text{Cay}(G : S)$ on orientable surfaces.

Theorem 3.2 *Let $\Gamma = \text{Cay}(G : S)$ be a Cayley graph with $\text{Aut}\Gamma = R(G) \times H$. Then the number $n_{\mathcal{M}}^O(G : S)$ of non-equivalent maps underlying Γ on orientable surfaces is*

$$n_{\mathcal{M}}^O(G : S) = \frac{1}{|G||H|} \sum_{\xi \in O_G} |\mathcal{E}_{\xi}| (|S| - 1)!^{\frac{|G|}{\sigma(\xi)}},$$

where, the means of notations \mathcal{E}_{ξ}, O_G are the same as in Theorem 3.1.

Proof By Corollary 3.1, we know that

$$n_{\mathcal{M}}^O(G : S) = \frac{1}{|G||H|} \times \sum_{\xi \in R(G) \times H} |\Phi^O(\xi)|.$$

Similar to the proof of Theorem 3.1 by applying Theorem 2.3 and Corollary 3.1, we get that for $\forall \xi \in R(G) \times H$,

$$|\Phi^O(\xi)| = (|S| - 1)!^{\frac{|G|}{\sigma(\xi)}}.$$

Therefore,

$$n_{\mathcal{M}}^O(G : S) = \frac{1}{|G||H|} \sum_{\xi \in O_G} |\mathcal{E}_{\xi}| (|S| - 1)!^{\frac{|G|}{\sigma(\xi)}}. \quad \spadesuit$$

Notice that for a given Cayley graph $\text{Cay}(G : S)$ of a finite group G , $n_{\mathcal{M}}^O(G : S) + n_{\mathcal{M}}^N(G : S) = n_{\mathcal{M}}^L(G : S)$. Whence, we get the number of non-equivalent maps underlying a graph $\text{Cay}(G : S)$ on non-orientable surfaces.

Theorem 3.3 *Let $\Gamma = \text{Cay}(G : S)$ be a Cayley graph with $\text{Aut}\Gamma = R(G) \times H$. Then the number $n_{\mathcal{M}}^N(G : S)$ of non-equivalent maps underlying Γ on non-orientable surfaces is*

$$n_{\mathcal{M}}^N(G : S) = \frac{1}{|G||H|} \sum_{\xi \in O_G} |\mathcal{E}_{\xi}| (2^{\alpha(S, \xi)} - 1) (|S| - 1)!^{\frac{|G|}{\sigma(\xi)}},$$

where O_G denotes the representation set of conjugate class of $\text{Aut}\Gamma$, \mathcal{E}_ξ the conjugate class in $\text{Aut}\Gamma$ containing ξ and $\alpha(S, \xi)$ is the same as in Theorem 3.1.

Since $R(G) \cong R(G) \times \{1_{\text{Aut}\Gamma}\}$ and the condition $s \in S, t \in G$ such that $s = t\xi^{\frac{o(\xi)}{2}}$ turns to $s = t\xi^{\frac{o(\xi)}{2}}t^{-1}$ when $\text{Aut}\Gamma = R(G)$, we get the number of non-equivalent maps underlying a GRR graph of a finite group by Theorems 3.1 – 3.3 as follows.

Corollary 3.3 *Let G be a finite group with a GRR graph $\Gamma = \text{Cay}(G : S)$. Then the numbers of non-equivalent maps underlying Γ on locally orientable, orientable and non-orientable surfaces are respective*

$$n_{\mathcal{M}}^L(G : S) = \frac{1}{|G|} \sum_{g \in O_G} |\mathcal{E}_g| 2^{\alpha_1(S, g)} (|S| - 1)!^{\frac{|G|}{o(g)}},$$

$$n_{\mathcal{M}}^O(G : S) = \frac{1}{|G|} \sum_{g \in O_G} |\mathcal{E}_g| (|S| - 1)!^{\frac{|G|}{o(g)}}$$

and

$$n_{\mathcal{M}}^N(G : S) = \frac{1}{|G|} \sum_{g \in O_G} |\mathcal{E}_g| (2^{\alpha_1(S, g)} - 1) (|S| - 1)!^{\frac{|G|}{o(g)}},$$

where O_G denotes the representation set of conjugate class of G , \mathcal{E}_g the conjugate class in G containing g and

$$\alpha_1(S, g) = \begin{cases} \frac{|G||S|-2|G|}{2o(g)}, & \text{if } g \in \Theta' \\ \frac{|G||S|+2l(g)-2|G|}{2o(g)}, & \text{if } g \in \Delta'. \end{cases}$$

where, $\Theta' = \{g | o(g) \equiv 1 \pmod{2} \vee o(g) \equiv 0 \pmod{2}, \forall s \in S, s \notin \mathcal{E}_g^{\frac{o(g)}{2}}\}$ and $\Delta' = \{g | o(g) \equiv 0 \pmod{2}, \exists t_i \in G, 1 \leq i \leq l(g), l(g) \equiv 0 \pmod{\frac{o(g)}{2}} \text{ such that } t_i g^{\frac{o(g)}{2}} t_i^{-1} \in S\}$.

Corollary 3.4 *Let G be a finite group of odd order with a GRR graph $\Gamma = \text{Cay}(G : S)$. Then the number $n_{\mathcal{M}}^L(G : S)$ of non-equivalent maps of graph Γ on surfaces is*

$$n_{\mathcal{M}}^L(G : S) = \frac{1}{|G|} \sum_{g \in O_G} |\mathcal{E}_g| 2^{\frac{|G||S|-2|G|}{2o(g)}} (|S| - 1)!^{\frac{|G|}{o(g)}}.$$

4. Examples and calculation for GRR graphs

Hetze and Godsil investigated GRR for solvable, non-solvable finite groups, respectively. They proved^{[4],[21]} that every group has GRR unless it belongs to one of the following groups:

- (a) abelian groups of exponent greater than 2;
- (b) generalized dicyclic groups;
- (c) thirteen "exceptional" groups:
 - (1) Z_2^2, Z_2^3, Z_2^4 ;
 - (2) D_6, D_8, D_{10} ;
 - (3) A_4 ;
 - (4) $\langle a, b, c \mid a^2 = b^2 = c^2 = 1, abc = bca = cab \rangle$;
 - (5) $\langle a, b \mid a^8 = b^2 = 1, bab = b^5 \rangle$;
 - (6) $\langle a, b, c \mid a^3 = c^3 = b^2 = 1, ac = ca, (ab)^2 = (cb)^2 = 1 \rangle$;
 - (7) $\langle a, b, c \mid a^3 = b^3 = c^3 = 1, ac = ca, bc = cb, c = a^{-1}b^{-1}ab \rangle$;
 - (8) $Q_8 \times Z_3, Q_8 \times Z_4$.

Based on results in previous section, the constructions given in [4] – [5] and Corollary 3.2, we give some calculations for the numbers of non-equivalent maps underlying a GRR graph on surfaces for some special groups.

Calculation 4.1 *Symmetric group Σ_n*

Using the notation (\bar{k}) denotes a partition of the integer n : $(\bar{k}) = k_1, k_2, \dots, k_n$ such that $1k_1 + 2k_2 + \dots + nk_n = n$ and $lcm(\bar{k})$ the least common multiple of the integers $1(k_1 \text{ times}), 2(k_2 \text{ times}), \dots, n(k_n \text{ times})$, i.e, $lcm(\bar{k}) = [1(k_1 \text{ times}), 2(k_2 \text{ times}), \dots, n(k_n \text{ times})]$. Godsil proved that^[5] every symmetric group Σ_n with $n \geq 19$ has a cubic GRR with $S = \{x, y, y^{-1}\}$, where $x^2 = y^3 = e$. Since $|\Sigma_n| = n!$, we get that the numbers of non-equivalent maps underlying a cubic GRR graph of Σ_n are

$$n_{\mathcal{M}}^L(\Sigma_n : S) = \frac{1}{n!} \times \sum_{g \in \Sigma_n} 2^{\alpha_1(S,g)} \times 2!^{\frac{|\Sigma_n|}{o(g)}} = \frac{1}{n!} \times \sum_{g \in \Sigma_n} 2^{\alpha(S,g) + \frac{n!}{o(g)}}$$

and

$$\begin{aligned} n_{\mathcal{M}}^O(\Sigma_n : S) &= \frac{1}{n!} \times \sum_{g \in \Sigma_n} 2!^{\frac{|\Sigma_n|}{o(g)}} \\ &= \frac{1}{n!} \times \sum_{(\bar{k})} \frac{n!}{\prod_{i=1}^n i^{k_i} k_i!} \times 2^{\frac{n!}{lcm(\bar{k})}} = \sum_{(\bar{k})} \frac{2^{\frac{n!}{lcm(\bar{k})}}}{\prod_{i=1}^n i^{k_i} k_i!}, \end{aligned}$$

and

$$n_{\mathcal{M}}^N(\Sigma_n : S) = \frac{1}{n!} \times \sum_{g \in \Sigma_n} 2^{\frac{n!}{o(g)}} (2^{\alpha_1(S,g)} - 1)$$

For the case $n = 6m + 1$, we know that^[5] $x = b_1$ if $m \equiv 1(\text{mod}2)$ and $x = b_2$ if $m \equiv 0(\text{mod}2)$, where

$$\begin{aligned} b_1 &= (1, 4)(2, n)(3, n-1)(n-6, n-3)(n-5, n-2) \\ &\times \prod_{r=1}^{m-2} (6r, 6r+3)(6r+1, 6r+4)(6r+2, 6r+5) \end{aligned}$$

and

$$b_2 = b_1(n-12, n-9).$$

Notice that $b_1 \in \mathcal{E}_{[1^3 2^{3m-1}]}$ and $b_2 \in \mathcal{E}_{[1^5 2^{3m-2}]}$. We define the sets A_1, B_1, A_2 and B_2 as follows.

$$A_1 = \{g | g \in \Sigma_n, o(g) \equiv 1(\text{mod}2) \text{ or } o(g) \equiv 0(\text{mod}2) \text{ but } g^{\frac{o(g)}{2}} \notin \mathcal{E}_{[1^3 2^{3m-1}]}\},$$

$$B_1 = \{g | g \in \Sigma_n, o(g) \equiv 0(\text{mod}2) \text{ but } g^{\frac{o(g)}{2}} \notin \mathcal{E}_{[1^3 2^{3m-1}]}\}$$

and

$$A_2 = \{g | g \in \Sigma_n, o(g) \equiv 1(\text{mod}2) \text{ or } o(g) \equiv 0(\text{mod}2) \text{ but } g^{\frac{o(g)}{2}} \notin \mathcal{E}_{[1^5 2^{3m-2}]}\},$$

$$B_2 = \{g | g \in \Sigma_n, o(g) \equiv 0(\text{mod}2) \text{ but } g^{\frac{o(g)}{2}} \notin \mathcal{E}_{[1^5 2^{3m-2}]}\}.$$

For $\forall \theta \in \Sigma_n$, if $\zeta \in A_i$ or B_i , $i = 1$ or 2 , it is clear that $\theta\zeta\theta^{-1} \in A_i$ or B_i . Whence, $\mathcal{E}_\zeta \subset A_i$ or B_i . Now calculation shows that

$$l(g) = \begin{cases} 3!(n-3)!!, & \text{if } g \in \mathcal{E}_{[1^3 2^{3m-1}]} \\ 5!(n-2)!!, & \text{if } g \in \mathcal{E}_{[1^5 2^{3m-2}]} \\ 0, & \text{otherwise.} \end{cases}$$

Therefore, we have that

$$\begin{aligned}
 n_{\mathcal{M}}^L(\Sigma_n : S)|_{m \equiv 1 \pmod{2}} &= \frac{\sum_{g \in \Sigma_n} 2^{\alpha_1(S,g) + \frac{n!}{o(g)}}}{n!} \\
 &= \frac{1}{n!} \times \sum_{(\bar{k})} \frac{n!}{\prod_{i=1}^n i^{k_i} k_i!} \times 2^{\alpha_1(S,(\bar{k})) + \frac{n!}{lcm(k)}} \\
 &= \sum_{(\bar{k})} \frac{2^{\alpha_1(S,(\bar{k})) + \frac{n!}{lcm(k)}}}{\prod_{i=1}^n i^{k_i} k_i!},
 \end{aligned}$$

where,

$$\alpha_1(S, (\bar{k})) = \begin{cases} \frac{n!}{2 \cdot lcm(k)}, & \text{if } \mathcal{E}(\bar{k}) \subset A_1 \\ \frac{n! + 12(n-3)!}{2 \cdot lcm(k)}, & \text{if } \mathcal{E}(\bar{k}) \subset B_1 \end{cases}$$

and

$$\begin{aligned}
 n_{\mathcal{M}}^L(\Sigma_n : S)|_{m \equiv 0 \pmod{2}} &= \frac{\sum_{g \in \Sigma_n} 2^{\alpha'_1(S,g) + \frac{n!}{o(g)}}}{n!} \\
 &= \sum_{(\bar{k})} \frac{2^{\alpha'_1(S,(\bar{k})) + \frac{n!}{lcm(k)}}}{\prod_{i=1}^n i^{k_i} k_i!},
 \end{aligned}$$

where

$$\alpha'_1(S, (\bar{k})) = \begin{cases} \frac{n!}{2 \cdot lcm(k)}, & \text{if } \mathcal{E}(\bar{k}) \subset A_2 \\ \frac{n! + 240(n-5)!}{2 \cdot lcm(k)}, & \text{if } \mathcal{E}(\bar{k}) \subset B_2. \end{cases}$$

Calculation 4.2 *Group generated by 3 involutions*

Let $G = \langle a, b, c | a^2 = b^2 = c^2 = e \rangle$ be a finite group of order n . In [5], Godsil proved that if $(\text{Aut}G)_S = e$, where $S = \{a, b, c\}$, then G has a GRR $\text{Cay}(G : S)$. Since any element of order 2 must have the form txt^{-1} , $t \in G$ and $x = a, b$ or c . We assume that for $\forall t \in G, tx \neq xt$, for $x = a, b, c$. Then for $\forall g \in G$,

$$l(g) = \begin{cases} n, & \text{if } o(g) \equiv 0 \pmod{2} \\ 0, & \text{if } o(g) \equiv 1 \pmod{2}. \end{cases}$$

Therefore, we get that

$$\alpha_1(S, g) = \begin{cases} \frac{n}{2o(g)}, & \text{if } o(g) \equiv 1(\text{mod}2) \\ \frac{3n}{2o(g)}, & \text{if } o(g) \equiv 0(\text{mod}2), \end{cases}$$

$$n_{\mathcal{M}}^L(G : S) = \frac{\sum_{o(g) \equiv 1(\text{mod}2)} 2^{\frac{3n}{2o(g)}} + \sum_{o(g) \equiv 0(\text{mod}2)} 2^{\frac{5n}{2o(g)}}}{n},$$

$$n_{\mathcal{M}}^O(G : S) = \frac{\sum_{g \in G} 2^{\frac{n}{o(g)}}}{n}$$

and

$$n_{\mathcal{M}}^N(G : S) = \frac{\sum_{o(g) \equiv 1(\text{mod}2)} 2^{\frac{n}{o(g)}} (2^{\frac{n}{2o(g)}} - 1) + \sum_{o(g) \equiv 0(\text{mod}2)} 2^{\frac{n}{o(g)}} (2^{\frac{3n}{2o(g)}} - 1)}{n}$$

Calculation 4.3 *Abelian group*

Let $k = |S|$. It has been proved that an abelian group G has GRR if and only if $G = (Z_2)^n$ for $n = 1$ or $n \geq 5$. Now for the abelian group $G = (Z_2)^n = \langle a \rangle \times \langle b \rangle \times \cdots \times \langle c \rangle$, every element in G has order 2. Calculation shows that

$$l(g) = \begin{cases} 2^n, & \text{if } g \in S \\ 0, & \text{if } g \notin S. \end{cases}$$

Whence, we get that

$$\alpha_1(S, g) = \begin{cases} (k-2)2^{n-2}, & \text{if } g \notin S \\ k2^{n-2}, & \text{if } g \in S. \end{cases}$$

Therefore, the numbers of non-equivalent maps underlying a GRR graph of $(Z_2)^n$ on locally orientable or orientable surfaces are

$$\begin{aligned} n_{\mathcal{M}}^L((Z_2)^n : S) &= \frac{1}{|G|} \times \sum_{g \in (Z_2)^n} 2^{\alpha_1(S, g)} (k-1)!^{\frac{|G|}{o(g)}} \\ &= \frac{1}{2^n} \times \left(\sum_{g \in S} 2^{k2^{n-2}} (k-1)!^{2^{n-1}} + \sum_{g \notin S, g \neq e} 2^{(k-2)2^{n-2}} (k-1)!^{2^{n-1}} \right) \\ &= \frac{2^{k2^{n-2}} k(k-1)!^{2^{n-1}} + (2^n - k - 1) 2^{(k-2)2^{n-2}} (k-1)!^{2^{n-1}}}{2^n} \\ &+ \frac{2^{(k-2)2^{n-2}} (k-1)!^{2^n}}{2^n}, \end{aligned}$$

and

$$\begin{aligned} n_{\mathcal{M}}^{\mathcal{O}}((\mathbb{Z}_2)^n : S) &= \frac{1}{2^n} \times \sum_{g \in (\mathbb{Z}_2)^n} (k-1)!^{\frac{2^n}{o(g)}} \\ &= \frac{(k-1)!^{2^n} + (2^n - 1)(k-1)!^{2^{n-1}}}{2^n}. \end{aligned}$$

References

- [1] N.L.Biggs and A.T.White, *Permutation Groups and Combinatoric Structure*, Cambridge University Press (1979).
- [2] Edmonds.J, A combinatorial representation for polyhedral surfaces, *Notices Amer. Math. Soc* 7 (1960) 646.
- [3] X.G.Fang, C.H.Li, J.Wang and M.Y.Xu, On cubic graphical regular representation of finite simple groups (preprint, Peking University,2001).
- [4] C.D.Godsil, On the full automorphism group of a graph, *Combinatorica*, 1(1981), 243-256.
- [5] C.D.Godsil, The automorphism groups of some cubic Cayley graphs,*Europ.J. Combin.* 4(1983),25-32
- [6] Jin Ho Kwak and Jaeun Lee, Enumeration of graph embeddings, *Discrete Math*, 135(1994), 129-151.
- [7] V.A.Liskovets, Enumeration of non-isomorphic planar maps,*Sel. Math. Sov*, 4;4(1985), 303-323.
- [8] V.A.Liskovets, A reductive technique for Enumerating non-isomorphic planar maps, *Discrete Math*, 156(1996), 197-217.
- [9] V.A.Liskovets and T.R.S.Walsh, The enumeration of non-isomorphic 2-connected planar maps,*Canad.J.Math*, 35(1983), 417-435.
- [10] Y.P.Liu, *Enumerative Theory of Maps*, Kluwer Academic Publisher, Dordrecht / Boston / London (1999).
- [11] L.F. Mao and Y.P.Liu, New automorphism groups identity of trees, *Chinese advances Math*, 1(2003).
- [12] L.F. Mao and Y.P.Liu, An approach for constructing 3-connected non-hamiltonian cubic map on surfaces, *Chinese OR Transactions*, 4(2001),1-7.
- [13] L.F. Mao and Y.P.Liu, The number of complete maps on surfaces, *arXiv: math.GM/0607*.

- [14] B.P.Mull,R.G.Rieper and A.T.White, Enumeration 2-cell imbeddings of connected graphs, *Proc.Amer.Math.Soc*, 103(1988), 321-330.
- [15] B.P.Mull, Enumerating the orientable 2-cell imbeddings of complete bipartite graphs, *J.Graph Theory*, vol 30, 2(1999),77-90.
- [16] S.Negami, Enumeration of projective -planar embeddings of graphs, *Discrete Math*, 62(1986), 299-306.
- [17] W.T.Tutte, *Graph Theory*, Combridge university Press (2001).
- [18] W.T.Tutte, What is a maps? in *New Directions in the Theory of Graphs* (ed.by F.Harary), Academic Press (1973), 309-325.
- [19] A.T.White, *Graphs of Group on Surfaces- interactions and models*, Elsevier Science B.V. (2001).
- [20] M.Y.Xu et al, *Introduction to finite groups (II)*, Science Press, Beijing (1999).
- [21] M.Y.Xu, Automorphism groups and isomorphisms of Cayley digraphs, *Discrete Math*, 182(1998), 309-319.

21math-001-009



Riemann曲面上Hurwitz定理的组合推广*

毛林繁 田丰

(中国科学院数学与系统科学研究院, 北京, 100080)

摘要: 一个 Riemann 曲面是在一个可定向曲面上赋予了由其局部坐标覆盖导出的解析结构的曲面, 其自同构定义为该 Riemann 曲面上的保角自同胚。关于 Riemann 曲面的自同构群, 经典的结果由 Hurwitz 在 19 世纪得到, 即任何一个亏格 $g \geq 2$ 的 Riemann 曲面 \mathcal{S} , 其上的守向自同构群 $|\text{Aut}^+ \mathcal{S}| \leq 84(g-1)$ 。后人采用 Fuchsian 群的方法, 于上个世纪 60 年代起对此结果进行了许多细致的推广, 至今仍不时能看到这方面的论文。本文的主要目的, 在于利用地图理论对 Riemann 曲面自同构进行组合刻画, 得到图的自同构子群为地图自同构群的充分必要条件和地图自同构群的特性及阶的界, 并证明了由此可以推出 Hurwitz 定理以及后人的一些推广, 同时提出组合上一些对应的研究方向。

A Combinatorial Refinement of Hurwitz Theorem on Riemann surfaces

Abstract: A *Riemann* surface is an orientable surface endowed with an analytic structure. Its automorphisms are defined to be conformal mappings on this surface. For the automorphism group of a *Riemann* surface \mathcal{S} , a well-known result is obtained by *Hurwitz* in 19th century, i.e., $|\text{Aut}^+ \mathcal{S}| \leq 84(g-1)$ for a *Riemann* surface \mathcal{S} with $g \geq 2$. Since then, many refinements for this result are got by applying *Fuchsian* group. Such works can be also found on journals today.

¹曾在第二届中国科学院博士后前沿与交叉学科学术论坛上交流, 2004 年 12 月, 北京。

The purpose of this paper is to find a combinatorial description for *Riemann* surfaces by applying combinatorial maps, get a necessary and sufficient condition for an automorphism subgroup of a graph G to be an automorphism group of a map underlying G and the bounds for the order of automorphism groups of maps. These results enables us to deduce easily the *Hurwitz* theorem and some other results. Further considerations for automorphisms of *Klein* surfaces are presented in the final section.

关键词: Riemann 曲面, 地图, 图的嵌入, 守向自同构, 自同构, 群作用。

分类号 AMS(2000): 05C10, 05C25, 30F10, 30F35, 30F99

1. 引言

本文中所讨论的曲面均为可定向闭曲面, 图均为连通的简单图。一个 *Riemann* 曲面定义为一个连通的 Hausdorff 空间 \mathcal{S} , 其具有一个坐标覆盖 $\{U_i, \Phi_i\}$ 满足下述性质 [5][16]:

- (C_1) 每个 U_i 是 \mathcal{S} 内的开集, 并且 $\cup U_i = M$;
- (C_2) 映射 $\Phi_i : U_i \rightarrow C^1$ 是 U_i 到复平面 C^1 上的同胚映射;
- (C_3) 对 $\forall i, j$, 复合映射

$$\Phi_i \circ \Phi_j^{-1} : \Phi_j(U_i \cap U_j) \rightarrow \Phi_i(U_i \cap U_j)$$

是解析的。易知, 解析函数是保角映射。Riemann 曲面上的自同构定义为其上 1-1 的保角映射。

作为解释多值复函数的一种数学模型, Riemann 曲面是近代数学中许多分之, 如代数几何、微分几何以及函数论等中的简单但十分重要的工具, 其本身在数学以及其他应用科学中具有十分重要的地位, 也正因为此, 许多不同领域的数学家曾在这一领域作出过重要的贡献。Schwartz 首先证明了 Riemann 曲面上的自同构是有限的 [5], 这一特征吸引人们去进一步算出给定一个 Riemann 曲面, 其上具体的自同构个数。Hurwitz 得到了其如下上界 [5]:

给定一个亏格 $g(\mathcal{S}) \geq 2$ 的 Riemann 曲面 \mathcal{S} , 其上的守向自同构群 $|\text{Aut}^+ \mathcal{S}| \leq 84(g(\mathcal{S}) - 1)$.

Accola 于 1968 年得到了 [1]Riemann 曲面 \mathcal{S} 上自同构个数的下界 $|\text{Aut}^+ \mathcal{S}| \geq 8(g(\mathcal{S}) + 1)$. Harvey [7] 和 Maclachlan [11] 对于 Riemann 曲面上循环自同构群和交换

自同构群的阶给出了估界, 其上界分别为 $2(2g(\mathcal{S}) + 1)$ 和 $12(g(\mathcal{S}) - 1)$ 。文献 [13] 中给出了阶 $\geq 3g(\mathcal{S})$ 而 $\leq 4g(\mathcal{S}) + 2$ 的自同构对应的 Riemann 曲面 \mathcal{S} 及自同构的具体表现形式。

本文的主要目的, 在于采用地图的方法研究 Riemann 曲面上自同构的组合特征, 进而采用地图的组合参数刻画 Riemann 曲面的自同构特征, 得到其阶的已知界。采用的 Riemann 曲面、地图及置换群中的术语与符号, 分别见文献 [5][16]、[9][10] 和 [2]。

2. Riemannian 曲面的组合地图模型

地图是曲面上的一种划分, 这种划分使得其每个面均同胚于 2 维圆盘 $\{(x, y) | x^2 + y^2 < 1\}$ 。地图的定义有许多种, 拓扑图论中一般采用图的曲面嵌入定义地图。Tutte 于 1973 年给出了地图的代数定义如下 [9][10][15]:

一个地图 $M = (\mathcal{X}_{\alpha, \beta}, \mathcal{P})$, 定义为在基础集合 X 的 4 元胞腔 $Kx, x \in X$, 的无公共元的并集 $\mathcal{X}_{\alpha, \beta}$ 上的一个基本置换 \mathcal{P} , 且满足下面的公理 1 和公理 2, 这里 $K = \{1, \alpha, \beta, \alpha\beta\}$ 为 Klein 4- 元群, 所谓 \mathcal{P} 为基本置换, 即不存在正整数 k , 使得 $\mathcal{P}^k x = \alpha x$ 。

公理 1: $\alpha\mathcal{P} = \mathcal{P}^{-1}\alpha$;

公理 2: 群 $\Psi_J = \langle \alpha, \beta, \mathcal{P} \rangle$ 在 $X_{\alpha, \beta}$ 上可传递。

依据公理 1, 地图中的顶点定义为作用于 $\mathcal{X}_{\alpha, \beta}$ 上的置换 \mathcal{P} 循环分解中的共轭对 $\{C, \alpha C \alpha^{-1}\}$, 边则定义为 Klein 4- 元群在 $\mathcal{X}_{\alpha, \beta}$ 上的作用轨道, 例如, $\forall x \in \mathcal{X}_{\alpha, \beta}$, $\{x, \alpha x, \beta x, \alpha\beta x\}$ 是地图 M 的一条边。从几何直观上讲, 任何地图 M 均为一个图 G 在曲面上的嵌入 (参见文献 [9],[10]), 记为 $M = M(G)$ 和 $G = G(M)$, 图 G 称为地图 M 的基础图。若在地图 M 中对元 $r \in \mathcal{X}_{\alpha, \beta}$ 标定, 则称 M 为标根地图, 记为 M^r 。

若群 $\Psi_I = \langle \alpha\beta, \mathcal{P} \rangle$ 在集合 $\mathcal{X}_{\alpha, \beta}$ 上的作用是传递的, 则称 $M = (X_{\alpha, \beta}, \mathcal{P})$ 是不可定向的, 否则, 可定向的。

例如, 图 1 中给出了 4 阶完全图 K_4 在环面上的一种嵌入, 其一个面长为 4 而另一个面长为 8。



图 1

可以代数表示如下:

地图 $(\mathcal{X}_{\alpha,\beta}, \mathcal{P})$, 这里 $\mathcal{X}_{\alpha,\beta} = \{x, y, z, u, v, w, \alpha x, \alpha y, \alpha z, \alpha u, \alpha v, \alpha w, \beta x, \beta y, \beta z, \beta u, \beta v, \beta w, \alpha\beta x, \alpha\beta y, \alpha\beta z, \alpha\beta u, \alpha\beta v, \alpha\beta w\}$, 而

$$\begin{aligned} \mathcal{P} = & (x, y, z)(\alpha\beta x, u, w)(\alpha\beta z, \alpha\beta u, v)(\alpha\beta y, \alpha\beta v, \alpha\beta w) \\ & \times (\alpha x, \alpha z, \alpha y)(\beta x, \alpha w, \alpha u)(\beta z, \alpha v, \beta u)(\beta y, \beta w, \beta v) \end{aligned}$$

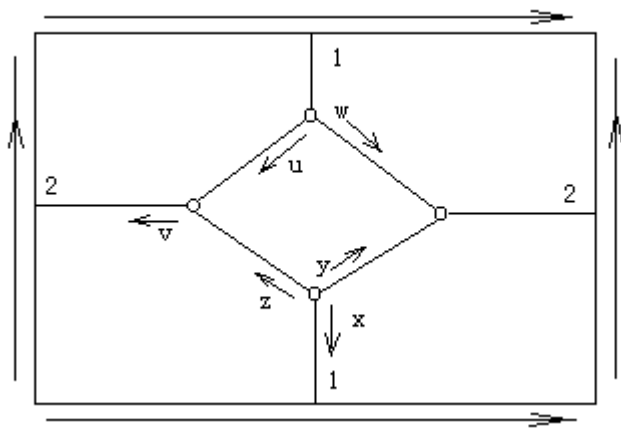
地图的 4 个顶点为 $\{(x, y, z), (\alpha x, \alpha z, \alpha y)\}$, $\{(\alpha\beta x, u, w), (\beta x, \alpha w, \alpha u)\}$, $\{(\alpha\beta z, \alpha\beta u, v), (\beta z, \alpha v, \beta u)\}$ 和 $\{(\alpha\beta y, \alpha\beta v, \alpha\beta w), (\beta y, \beta w, \beta v)\}$. 6 条边为 $\{e, \alpha e, \beta e, \alpha\beta e\}$, 这里, $e \in \{x, y, z, u, v, w\}$.

两个地图 $M_1 = (\mathcal{X}_{\alpha,\beta}^1, \mathcal{P}_1)$ 和 $M_2 = (\mathcal{X}_{\alpha,\beta}^2, \mathcal{P}_2)$ 称为同构的, 若存在一个 1-1 映射 $\tau: \mathcal{X}_{\alpha,\beta}^1 \rightarrow \mathcal{X}_{\alpha,\beta}^2$, 使得 $\forall x \in \mathcal{X}_{\alpha,\beta}^1, \tau\alpha(x) = \alpha\tau(x), \tau\beta(x) = \beta\tau(x)$ 且 $\tau\mathcal{P}_1(x) = \mathcal{P}_2\tau(x)$. 称 τ 为这两个地图间的一个同构. 若 $M_1 = M_2 = M$, 则 M_1 与 M_2 间的同构称为地图 M 的自同构. 地图 M 的所有自同构, 在复合运算下构成一个群, 称为地图 M 的自同构群, 记为 $\text{Aut}M$. 类似地, 两个标根地图 M_1^r, M_2^r 称为同构, 若它们之间存在一个地图同构 θ , 使得 $\theta(r_1) = r_2$, 这里, r_1, r_2 分别表示地图 M_1^r, M_2^r 的根. 记标根地图 M^r 的自同构群为 $\text{Aut}M^r$. 我们已经知道, 群 $\text{Aut}M^r$ 为平凡群.

Riemann 曲面、地图的自同构与该曲面上的三角剖分的自同构群之间有一个熟知的关系, 依据 Jones 和 Singerman 给出的可定向曲面上的地图理论和 Tucker 对曲面上群作用的研究, 我们可以知道 Riemann 曲面上的自同构与地图自同构之间的下述关系, 由此导出了研究 Riemann 曲面的组合方法.

定理 2.1^{[8][14]} 设 G 为 Riemann 曲面 S 上的一个自同构群, 则 S 上存在一个地图 M , 使得 G 为地图 M 的自同构群; 特别地, 曲面 S 上存在一个基础图为 Cayley 图的地图 M^* , 使 G 得是 M^* 的自同构群。

推论 2.1 曲面 S 上若存在一个地图 M , 则 $\text{Aut}S \supseteq \text{Aut}M$.

推论 2.2 曲面 S 上的地图 M 的阶若存在上界, 即 $|\text{Aut}M| \leq C$, 这里 C 与地图 M 无关的一个常数, 则 $|\text{Aut}S| \leq C$.

3. 图的自同构群及其在 4 元胞腔上的作用

设以 $\Gamma = (V, E)$ 为一个连通的简单图, 其自同构群记为 $\text{Aut}\Gamma$. 取基础集 $X = E(\Gamma)$, 则其 4 元胞腔 $\mathcal{X}_{\alpha, \beta}$ 定义为:

$$\mathcal{X}_{\alpha, \beta} = \bigcup_{x \in X} \{x, \alpha x, \beta x, \beta \alpha \beta x\},$$

这里, $K = \{1, \alpha, \beta, \alpha\beta\}$ 为 Klein 4 元群。

对任意元 $\forall g \in \text{Aut}\Gamma$, 定义 g 在 $\mathcal{X}_{\alpha, \beta}$ 上的作用扩张 $g|_{\mathcal{X}_{\alpha, \beta}}$ 如下, 这里 $X = E(G)$:

对任意元 $\forall x \in \mathcal{X}_{\alpha, \beta}$, 若 $x^g = y$, 定义 $(\alpha x)^g = \alpha y$, $(\beta x)^g = \beta y$ 及 $(\alpha\beta x)^g = \alpha\beta y$.

设地图 $M = (\mathcal{X}_{\alpha, \beta}, \mathcal{P})$, 对自同构 $g \in \text{Aut}M$ 和任意顶点 $\forall u, v \in V(M)$, $g|_{V(M)} : u \rightarrow v$, 若 $u^g = v$, 则称 g 为守向自同构; 若 $u^g = v^{-1}$, 则称 g 为反向自同构。对任意 $g \in \text{Aut}M$, 易知 g 或为守向的, 或为反向的, 且反向自同构与守向自同构的乘积为反向自同构, 而守向自同构与守向自同构、反向自同构与反向自同构的乘积均为守向自同构。 $G \leq \text{Aut}M$, 定义 $G^+ \leq G$ 为 G 中的守向自同构子群, 则 G^+ 为 G 中的指数为 2 的子群。设顶点 v 的表示为 $v = (x_1, x_2, \dots, x_{\rho(v)})(\alpha x_{\rho(v)}, \dots, \alpha x_2, \alpha x_1)$, 记由 v 生成的循环群为 $\langle v \rangle$ 。则对地图的自同构群, 有下述性质。

引理 3.1 若 $G \leq \text{Aut}M$ 为地图 M 的自同构子群, 则对 $\forall v \in V(M)$,

- (i) 若 $\forall g \in G, g$ 为守向自同构, 则 $G_v \leq \langle v \rangle$, 为循环群;
- (ii) $G_v \leq \langle v \rangle \times \langle \alpha \rangle$ 。

证明 (i) 设地图 $M = (\mathcal{X}_{\alpha, \beta}, \mathcal{P})$ 。由于任意 $\forall g \in G$ 为守向自同构, 故对 $\forall v \in V(M), h \in G_v$, 有 $v^h = v$ 。假定顶点

$$v = (x_1, x_2, \dots, x_{\rho(v)})(\alpha x_{\rho(v)}, \alpha x_{\rho(v)-1}, \dots, \alpha x_1).$$

则有

$$[(x_1, x_2, \dots, x_{\rho(v)})(\alpha x_{\rho(v)}, \dots, \alpha x_2, \alpha x_1)]^h = (x_1, x_2, \dots, x_{\rho(v)})(\alpha x_{\rho(v)}, \dots, \alpha x_2, \alpha x_1).$$

这样一来, 若 $h(x_1) = x_{k+1}, 1 \leq k \leq \rho(v)$, 则有

$$h = [(x_1, x_2, \dots, x_{\rho(v)})(\alpha x_{\rho(v)}, \alpha x_{\rho(v)-1}, \dots, \alpha x_1)]^k = v^k.$$

若 $h(x_1) = \alpha x_{\rho(v)-k+1}, 1 \leq k \leq \rho(v)$, 则有

$$h = [(x_1, x_2, \dots, x_{\rho(v)})(\alpha x_{\rho(v)}, \alpha x_{\rho(v)-1}, \dots, \alpha x_1)]^k \alpha = v^k \alpha.$$

但若 $h = v^k \alpha$, 易知 $v^h = v^\alpha = v^{-1}$, 即此时 h 不是守向自同构, 故有 $h = v^k, 1 \leq k \leq \rho(v)$, 即 G_v 中的元均为 v 的方幂. 设 ξ 为 G_v 中元的最小幂指数, 则 $G_v = \langle v^\xi \rangle \preceq \langle v \rangle$ 为由 v^ξ 生成的循环群.

(ii) 对 $\forall g \in G_v$, 有 $v^g = v$, 即

$$[(x_1, x_2, \dots, x_\rho)(\alpha x_\rho, \alpha x_{\rho-1}, \dots, \alpha x_1)]^g = (x_1, x_2, \dots, x_\rho)(\alpha x_\rho, \alpha x_{\rho-1}, \dots, \alpha x_1).$$

类似于 (i) 的证明, 知存在整数 $s, 1 \leq s \leq \rho$, 使得 $g = v^s$ 或 $g = v^s \alpha$. 故有 $g \in \langle v \rangle$ 或 $g \in \langle v \rangle \alpha$, 即

$$G_v \preceq \langle v \rangle \times \langle \alpha \rangle. \quad \spadesuit$$

引理 3.2 设 Γ 为一个连通图, 若 $G \preceq \text{Aut}\Gamma$, 且 $\forall v \in V(\Gamma), G_v \preceq \langle v \rangle \times \langle \alpha \rangle$, 则 G 在 $\mathcal{X}_{\alpha, \beta}$ 上的作用是半正则的.

证明 任取一个 4 元胞腔 $x \in \mathcal{X}_{\alpha, \beta}$, 我们证明 $G_x = \{\mathbf{1}_G\}$. 实际上, 设 $g \in G_x$, 则有 $x^g = x$, 特别地, 其关联的顶点 u 在 g 作用下不动, 即有 $u^g = u$. 设

$$u = (x, y_1, \dots, y_{\rho(u)-1})(\alpha x, \alpha y_{\rho(u)-1}, \dots, \alpha y_1),$$

则由于 $G_u \preceq \langle u \rangle \times \langle \alpha \rangle$, 故

$$x^g = x, y_1^g = y_1, \cdots, y_{\rho(u)-1}^g = y_{\rho(u)-1}$$

和

$$(\alpha x)^g = \alpha x, (\alpha y_1)^g = \alpha y_1, \cdots, (\alpha y_{\rho(u)-1})^g = \alpha y_{\rho(u)-1}$$

即对任一个关联于顶点 u 的 4 元胞腔 $e_u, e_u^g = e_u$. 依据自同构群 $\text{Aut}\Gamma$ 在 $\mathcal{X}_{\alpha,\beta}$ 上作用的定义, 知

$$(\beta x)^g = \beta x, (\beta y_1)^g = \beta y_1, \cdots, (\beta y_{\rho(u)-1})^g = \beta y_{\rho(u)-1}$$

且

$$(\alpha\beta x)^g = \alpha\beta x, (\alpha\beta y_1)^g = \alpha\beta y_1, \cdots, (\alpha\beta y_{\rho(u)-1})^g = \alpha\beta y_{\rho(u)-1}$$

这样, 任取一个元 $y \in \mathcal{X}_{\alpha,\beta}$, 设 y 关联的顶点为 w , 则由图的连通性, 知 Γ 中存在一条连接 u 和 w 的道路 $P(u, w) = uv_1v_2 \cdots v_s w$. 不失普遍性, 设 βy_k 关联于顶点 v_1 , 则由 $(\beta y_k)^g = \beta y_k$ 及 $G_{v_1} \preceq \langle v_1 \rangle \times \langle \alpha \rangle$, 知任一个关联于顶点 v_1 的 4 元胞腔 $e_{v_1}, e_{v_1}^g = e_{v_1}$.

类似地, 若任何一个关联于顶点 v_i 的 4 元胞腔 e_{v_i} 在 g 作用下不动, 即 $(e_{v_i})^g = e_{v_i}$, 则可以证明任何一个关联于顶点 v_{i+1} 的 4 元胞腔 $e_{v_{i+1}}$ 在 g 作用下不动. 依次类推, 得到任何一个关联于顶点 w 的 4 元胞腔 e_w 在 g 作用下不动, 特别地, 有 $y^g = y$.

故知 $g = \mathbf{1}_G$, 从而有 $G_x = \{\mathbf{1}_G\}$. \spadesuit

现在, 我们证明图的自同构群为地图自同构群的充要条件.

定理 3.1 设 Γ 为一个连通图. 若 $G \preceq \text{Aut}\Gamma$, 则 G 是以 Γ 为基础图的地图自同构群的充要条件是对 $\forall v \in V(\Gamma)$, 稳定子群 $G_v \preceq \langle v \rangle \times \langle \alpha \rangle$.

证明 依据引理 3.1(ii) 知条件是必要的. 现证明条件的充分性.

由引理 3.2 知 G 在 $\mathcal{X}_{\alpha,\beta}$ 上的作用是半正则的, 即对 $\forall x \in \mathcal{X}_{\alpha,\beta}$, 有 $|G_x| = 1$, 故元 x 在 G 作用下的轨道长度 $|x^G| = |G_x||x^G| = |G|$, 即 $\forall x \in \mathcal{X}_{\alpha,\beta}$ 在 G 作用下的轨道长度均为 $|G|$.

设 G 在 $V(\Gamma)$ 上作用共有 s 条轨道 O_1, O_2, \cdots, O_s , 这里 $O_1 = \{u_1, u_2, \cdots, u_k\}$, $O_2 = \{v_1, v_2, \cdots, v_l\}, \cdots, O_s = \{w_1, w_2, \cdots, w_t\}$. 我们构造出 Γ 中各顶点的旋, 得到在 G 作用下不动的置换 \mathcal{P} .

注意, 对 $\forall u \in V(\Gamma)$, 由 $|G| = |G_u||u^G|$, 知 $[k, l, \dots, t] \mid |G|$, 这里 $[k, l, \dots, t]$ 表示 k, l, \dots, t 的最小公倍数.

我们首先确定出轨道 O_1 中各顶点的旋. 任取顶点 $u_1 \in O_1$, 设稳定子群 G_{u_1} 的表示为 $\{1_G, g_1, g_2g_1, \dots, \prod_{i=1}^{m-1} g_{m-i}\}$, 这里 $m = |G_{u_1}|$ 及图 Γ 中关联于顶点 u_1 的 4 元胞腔集合为 $\widetilde{N}(u_1)$. 首先采用以下方法对 $\widetilde{N}(u_1)$ 的元进行排序. 取 4 元胞腔 $u_1^a \in \widetilde{N}(u_1)$, 用 G_{u_1} 在 u_1^a 和 αu_1^a 上分别作用, 得到 4 元胞腔子集 $A_1 = \{u_1^a, g_1(u_1^a), \dots, \prod_{i=1}^{m-1} g_{m-i}(u_1^a)\}$ 和 $\alpha A_1 = \{\alpha u_1^a, \alpha g_1(u_1^a), \dots, \alpha \prod_{i=1}^{m-1} g_{m-i}(u_1^a)\}$. 注意由图的自同构群在 4 元胞腔上的作用定义, 知 $A_1 \cap \alpha A_1 = \emptyset$. 将 A_1 中的元排序为 $\overrightarrow{A_1} = u_1^a, g_1(u_1^a), \dots, \prod_{i=1}^{m-1} g_{m-i}(u_1^a)$.

若 $\widetilde{N}(u_1) \setminus (A_1 \cup \alpha A_1) = \emptyset$, 则 $\widetilde{N}(u_1)$ 中的元的排序结果就是 $\overrightarrow{A_1}$. 若 $\widetilde{N}(u_1) \setminus (A_1 \cup \alpha A_1) \neq \emptyset$, 取 4 元胞腔 $u_1^b \in \widetilde{N}(u_1) \setminus (A_1 \cup \alpha A_1)$, 同样采用 G_{u_1} 作用于 u_1^b 上, 得到 $A_2 = \{u_1^b, g_1(u_1^b), \dots, \prod_{i=1}^{m-1} g_{m-i}(u_1^b)\}$ 和 $\alpha A_2 = \{\alpha u_1^b, \alpha g_1(u_1^b), \dots, \alpha \prod_{i=1}^{m-1} g_{m-i}(u_1^b)\}$. 将 $A_1 \cup A_2$ 中的元排序为

$$\overrightarrow{A_1 \cup A_2} = u_1^a, g_1(u_1^a), \dots, \prod_{i=1}^{m-1} g_{m-i}(u_1^a); u_1^b, g_1(u_1^b), \dots, \prod_{i=1}^{m-1} g_{m-i}(u_1^b)$$

若 $\widetilde{N}(u_1) \setminus (A_1 \cup A_2 \cup \alpha A_1 \cup \alpha A_2) = \emptyset$, 则 $A_1 \cup A_2$ 中的元的排序结果为 $\overrightarrow{A_1 \cup A_2}$. 否则, $\widetilde{N}(u_1) \setminus (A_1 \cup A_2 \cup \alpha A_1 \cup \alpha A_2) \neq \emptyset$, 可以取 4 元胞腔 $u_1^c \in \widetilde{N}(u_1) \setminus (A_1 \cup A_2 \cup \alpha A_1 \cup \alpha A_2)$. 一般地, 若已经得到 4 元胞腔子集 $A_1, A_2, \dots, A_r, 1 \leq r \leq 2k$, 同时已经确定出了其排序 $\overrightarrow{A_1 \cup A_2 \cup \dots \cup A_r}$, 若 $\widetilde{N}(u_1) \setminus (A_1 \cup A_2 \cup \dots \cup A_r \cup \alpha A_1 \cup \alpha A_2 \cup \dots \cup \alpha A_r) \neq \emptyset$, 则可以取 4 元胞腔 $u_1^d \in \widetilde{N}(u_1) \setminus (A_1 \cup A_2 \cup \dots \cup A_r \cup \alpha A_1 \cup \alpha A_2 \cup \dots \cup \alpha A_r)$, 定义 4 元胞腔子集

$$A_{r+1} = \{u_1^d, g_1(u_1^d), \dots, \prod_{i=1}^{m-1} g_{m-i}(u_1^d)\}$$

$$\alpha A_{r+1} = \{\alpha u_1^d, \alpha g_1(u_1^d), \dots, \alpha \prod_{i=1}^{m-1} g_{m-i}(u_1^d)\}$$

及 A_{r+1} 中元的排序

$$\overrightarrow{A_{r+1}} = u_1^d, g_1(u_1^d), \dots, \prod_{i=1}^{m-1} g_{m-i}(u_1^d).$$

规定 $\bigcup_{j=1}^{r+1} A_j$ 中元的排序结果为

$$\overrightarrow{\bigcup_{j=1}^{r+1} A_j} = \overrightarrow{\bigcup_{i=1}^r A_i; \overline{A_{r+1}}}.$$

故有

$$N(\widetilde{u_1}) = (\bigcup_{j=1}^k A_j) \cup (\alpha \bigcup_{j=1}^k A_j)$$

且 A_k 由 u_1^e 在稳定子群 G_{u_1} 作用下而得, 同时确定出了 4 元胞腔集合 $N(\widetilde{u_1})$ 中 $\bigcup_{j=1}^k A_j$ 元的排序结果 $\overrightarrow{\bigcup_{j=1}^k A_j}$.

定义顶点 u_1 的旋为

$$\varrho_{u_1} = (C)(\alpha C^{-1}\alpha),$$

这里,

$$C = (u_1^a, u_1^b, \dots, u_1^e; g_1(u_1^a), g_1(u_1^b), \dots, g_1(u_1^e), \dots, \prod_{i=1}^{m-1} (u_1^a), \prod_{i=1}^{m-1} (u_1^b), \dots, \prod_{i=1}^{m-1} (u_1^e)).$$

对任意顶点 $u_i \in O_1, 1 \leq i \leq k$, 设 $h \in G$, 使得 $h(u_1) = u_i$, 则定义顶点 u_i 的旋 ϱ_{u_i} 为

$$\varrho_{u_i} = \varrho_{u_1}^h = (C^h)(\alpha C^{-1}\alpha^{-1}).$$

则由于 O_1 是 G 在 $V(\Gamma)$ 上的轨道, 故有

$$\left(\prod_{i=1}^k \varrho_{u_i}\right)^G = \prod_{i=1}^k \varrho_{u_i}.$$

类似地, 定义轨道 O_2, \dots, O_s 中顶点的旋 $\varrho_{v_1}, \varrho_{v_2}, \dots, \varrho_{v_l}, \dots, \varrho_{w_1}, \varrho_{w_2}, \dots, \varrho_{w_t}$, 同样有

$$\left(\prod_{i=1}^l \varrho_{v_i}\right)^G = \prod_{i=1}^l \varrho_{v_i}.$$

.....

$$\left(\prod_{i=1}^t \varrho_{w_i}\right)^G = \prod_{i=1}^t \varrho_{w_i}.$$

现定义置换

$$\mathcal{P} = \left(\prod_{i=1}^k \varrho_{u_i}\right) \times \left(\prod_{i=1}^l \varrho_{v_i}\right) \times \cdots \times \left(\prod_{i=1}^t \varrho_{w_i}\right)$$

则由于 O_1, O_2, \dots, O_s 是 G 在 Γ 上的作用轨道, 有

$$\begin{aligned} \mathcal{P}^G &= \left(\prod_{i=1}^k \varrho_{u_i}\right)^G \times \left(\prod_{i=1}^l \varrho_{v_i}\right)^G \times \cdots \times \left(\prod_{i=1}^t \varrho_{w_i}\right)^G \\ &= \left(\prod_{i=1}^k \varrho_{u_i}\right) \times \left(\prod_{i=1}^l \varrho_{v_i}\right) \times \cdots \times \left(\prod_{i=1}^t \varrho_{w_i}\right) = \mathcal{P}. \end{aligned}$$

定义地图 $M = (\mathcal{X}_{\alpha, \beta}, \mathcal{P})$, 则 G 为 M 的自同构群。 \square

定理 3.2 设 Γ 为一个连通图。若 $G \preceq \text{Aut}\Gamma$, 则 G 是以 Γ 为基础图的地图守向自同构群的充要条件是对 $\forall v \in V(\Gamma)$, 稳定子群 $G_v \preceq \langle v \rangle$ 是循环群。

证明 根据引理 3.1(i), 知条件是必要的。注意在定理 3.1(i) 证明中构造各顶点旋的具体方法, 知 G 实际上是 M 的守向自同构群。 \square

因为循环群的子群仍然是循环群, 由定理 3.2 可以得到以下推论。

推论 3.1 设 Γ 为一个连通图, 则 Γ 的任一个循环自同构子群均为曲面上以 Γ 为基础图的地图守向自同构群。

推论 3.2 对任意正整数 n , 存在一个以 n 阶循环图为基础图的点传递地图 M , 使得 Z_n 为 M 的自同构群。

定理 3.1 和 3.2 给出了图的自同构子群为以其为基础图的地图自同构群的充分必要条件。文献 [6] 中, Gardiner 等人证明了在此条件上若进一步要求 G 在图上的传递性, 则曲面上存在一个以该图为基础图的对称地图。

4. 地图的自同构群

给定一个图 Γ , 其任意一种子图 P , 例如, 正则子图、圈、树、星、轮等称为图 Γ 的 P -子图。 $X = E(\Gamma)$, 定义 $\mathcal{X}_{\alpha, \beta}$ 中的子集 A 具有图性质 P , 若 A 的基础图是图 Γ

的 P -子图。对于地图的同构群，我们有下述结果。

定理 4.1 设 Γ 为一个连通图，若 $G \leq \text{Aut}\Gamma$ 且 $\forall v \in V(\Gamma)$ ，稳定子群 $G_v \leq \langle v \rangle \times \langle \alpha \rangle$ ，则对 4 元胞腔集 $\mathcal{X}_{\alpha, \beta}$ 中所有具有性质 P 的子集 A 构成的集合 $\mathcal{A}(P)$ ，有

$$[|v^G| | v \in V(\Gamma)] \mid |G|$$

和

$$|G| \mid |A| |\mathcal{A}|$$

这里， $[a, b, \dots]$ 表示 a, b, \dots 的最小公倍数。

证明 根据置换群中的一个熟知结果，对 $\forall v \in V(G)$ 有 $|G| = |G_v| |v^G|$ 。故 $|v^G| \mid |G|$ ，从而有

$$[|v^G| | v \in V(\Gamma)] \mid |G|$$

又由引理 3.2，知群 G 在 4 元胞腔集合 $\mathcal{X}_{\alpha, \beta}$ 上的作用是半正则的，即 $\forall x \in \mathcal{X}_{\alpha, \beta}$ ，有 $|G_x| = 1$ 。

现考虑群 G 在集合 $\mathcal{A}(P)$ 上的作用。注意若 $A \in \mathcal{A}(P)$ ，则由于 $G \leq \text{Aut}\Gamma$ ，故 $\forall g \in G, A^g \in \mathcal{A}(P)$ ，即 $A^G \subseteq \mathcal{A}(P)$ ，换言之， G 在 $\mathcal{A}(P)$ 上的作用是封闭的，从而我们可以采用 G 对 $\mathcal{A}(P)$ 中的 4 元胞腔进行分类。对 $\forall x, y \in \mathcal{A}(P)$ ，定义 $x \sim y$ 当且仅当存在 $g \in G$ ，使得 $x^g = y$ 。

根据 $|G_x| = 1$ ，即 $|x^G| = |G|$ 知 G 在 $\mathcal{X}_{\alpha, \beta}$ 上作用的任何一条轨道的长度均为 $|G|$ 。又由于 G 在 $\mathcal{A}(P)$ 上的作用是封闭的，故知 G 在 $\mathcal{A}(P)$ 上作用的任何一条轨道的长度也为 $|G|$ 。注意 $\mathcal{A}(P)$ 中共有 $|A| |\mathcal{A}|$ 个 4 元胞腔，从而有

$$|G| \mid |A| |\mathcal{A}|. \quad \square$$

取性质 P 为 Γ 中边重复次数不大于 2 的不同迹集，则有下列几个有用的推论。

推论 4.1 设 Γ 为一个连通图。若 $G \leq \text{Aut}\Gamma$ 且 $\forall v \in V(\Gamma)$ ，稳定子群 $G_v \leq \langle v \rangle \times \langle \alpha \rangle$ ，则对图 Γ 中边重复次数为 2 的迹集 $\mathcal{T}r_2$ ，有

$$|G| \mid (l|\mathcal{T}r_2|, l = |T| = \frac{|T|}{2} \geq 1, T \in \mathcal{T}r_2).$$

而对图 Γ 中无边重复的迹集 $\mathcal{T}r_1$ ，有

$$|G| \mid (2l|\mathcal{T}r_1|, l = |T| = \frac{|T|}{2} \geq 1, T \in \mathcal{T}r_1).$$

特别地, 设 G 为地图 M 的自同构群, $\phi(i, j)$ 表示地图 M 中面长为 i , 其中奇数边数为 j 的面数, 则有

$$|G| \mid ((2i - j)\phi(i, j), i, j \geq 1)$$

这里, (a, b, \dots) 表示 a, b, \dots 的最大公约数。

推论 4.2 设 Γ 为一个连通图。若 $G \leq \text{Aut}\Gamma$ 且 $\forall v \in V(\Gamma)$, 稳定子群 $G_v \leq \langle v \rangle \times \langle \alpha \rangle$, 取 $\mathcal{T}r$ 为树集合 \mathcal{T} , 则有

$$|G| \mid (2lt_l, l \geq 1),$$

这里, t_l 表示图 Γ 中边数为 l 的子树个数。

推论 4.3 设 Γ 为一个连通图。若 $G \leq \text{Aut}\Gamma$ 且 $\forall v \in V(\Gamma)$, 稳定子群 $G_v \leq \langle v \rangle \times \langle \alpha \rangle$, 则有

$$|G| \mid (2iv_i, i \geq 1),$$

这里, v_i 表示图 Γ 中次为 i 的顶点个数。

应用上述结论, 我们可以得到地图及 Riemann 上自同构的上界。

定理 4.2 设 Γ 为一个连通图。

(i) 若 $G \leq \text{Aut}\Gamma$ 是基础图为 Γ 的地图 $M, g(M) \geq 2$ 的守向自同构群, 则有

$$|G| \leq 84(g(M) - 1)$$

(ii) 若 $G \leq \text{Aut}\Gamma$ 是基础图为 Γ 的地图 $M, g(M) \geq 2$ 的自同构群, 则有

$$|G| \leq 168(g(M) - 1),$$

这里, $g(M)$ 为地图 M 的亏格。

证明 定义地图 M 的平均次 $\overline{\nu(M)}$ 与平均面次 $\overline{\phi(M)}$ 为:

$$\overline{\nu(M)} = \frac{1}{\nu(M)} \sum_{i \geq 1} iv_i$$

$$\overline{\phi(M)} = \frac{1}{\phi(M)} \sum_{j \geq 1} j \phi_j$$

这里, $\nu(M)$, $\phi(M)$, $\phi(M)$ 和 ϕ_j 分别表示 M 中的顶点数、面数、次为 i 的顶点数和次为 j 的面数.

则有 $\overline{\nu(M)}\nu(M) = \overline{\phi(M)}\phi(M) = 2\varepsilon(M)$, 故知, $\nu(M) = \frac{2\varepsilon(M)}{\nu(M)}$ 和 $\phi(M) = \frac{2\varepsilon(M)}{\phi(M)}$. 根据 Euler 公式

$$\nu(M) - \varepsilon(M) + \phi(M) = 2 - 2g(M)$$

这里, $\varepsilon(M)$, $g(M)$ 分别表示地图 M 的边数和亏格, 则有

$$\varepsilon(M) = \frac{2(g(M) - 1)}{\left(1 - \frac{2}{\nu(M)} - \frac{2}{\phi(M)}\right)}.$$

取整数 $k = \lceil \overline{\nu(M)} \rceil$ 和 $l = \lceil \overline{\phi(M)} \rceil$, 则有

$$\varepsilon(M) \leq \frac{2(g(M) - 1)}{1 - \frac{2}{k} - \frac{2}{l}}.$$

因为 $1 - \frac{2}{k} - \frac{2}{l} > 0$, 知 $k \geq 3, l > \frac{2k}{k-2}$, 直接验算, 知 $1 - \frac{2}{k} - \frac{2}{l}$ 的最大值为 21, 且仅当 $(k, l) = (3, 7)$ 或 $(7, 3)$ 时等号成立. 从而有

$$\varepsilon(M \leq 42(g(M) - 1)).$$

根据定理 4.1, 知 $|G| \leq 4\varepsilon(M)$, 同时, 若群 G 为守向的, 则 $|G| \leq 2\varepsilon(M)$. 故知

$$|G| \leq 168(g(M) - 1)$$

且群 G 为守向的, 则

$$|G| \leq 84(g(M) - 1).$$

等号成立当且仅当 $G = \text{Aut}M, (k, l) = (3, 7)$ 或 $(7, 3)$. \square

对 Riemann 曲面的自同构群, 有

推论 4.4 对任何亏格 $g \geq 2$ 的 Riemann 曲面 \mathcal{S} , 有

$$4g(\mathcal{S}) + 2 \leq |\text{Aut}^+ \mathcal{S}| \leq 84(g(\mathcal{S}) - 1)$$

和

$$8g(\mathcal{S}) + 4 \leq |\text{Aut} \mathcal{S}| \leq 168(g(\mathcal{S}) - 1),$$

证明 根据定理 4.2 和推论 2.2 知 $|\text{Aut} \mathcal{S}|$ 和 $|\text{Aut}^+ \mathcal{S}|$ 的上界。现在证明其下界。在任意一个亏格为 $g \geq 2$ 的 Riemann 曲面上, 我们构造一个对称地图 $M_k = (\mathcal{X}_k, \mathcal{P}_k)$, 这里 $k = 2g + 1$, 如下:

$$\mathcal{X}_k = \{x_1, x_2, \dots, x_k, \alpha x_1, \alpha x_2, \dots, \alpha x_k, \beta x_1, \beta x_2, \dots, \beta x_k, \alpha \beta x_1, \alpha \beta x_2, \dots, \alpha \beta x_k\}$$

$$\mathcal{P}_k = (x_1, x_2, \dots, x_k, \alpha \beta x_1, \alpha \beta x_2, \dots, \alpha \beta x_k)(\beta x_k, \dots, \beta x_2, \beta x_1, \alpha x_k, \dots, \alpha x_2, \alpha x_1).$$

易知 M_k 为对称地图, 且其守向自同构群 $\text{Aut}^+ M_k = \langle \mathcal{P}_k \rangle$ 。直接计算知当 $k \equiv 0(\text{mod}2)$ 时, M_k 有 2 个面, 而 $k \equiv 1(\text{mod}2)$ 时 M_k 仅有 1 个面。这样, 根据推论 2.1, 知

$$|\text{Aut}^+ \mathcal{S}| \geq 2\varepsilon(M_k) \geq 4g + 2.$$

同时,

$$|\text{Aut} \mathcal{S}| \geq 4\varepsilon(M_k) \geq 8g + 4. \quad \square$$

5. 组合引深

1. 采用组合的方法, 我们证明了 Hurwitz 定理, 同时证明了其等号成立当且仅当其对应地图的顶点次为 3, 面长为 7, 或反之, 顶点次为 7 而面长为 3, 且为对称地图。这类对称地图的存在性 Macbeath 在文献 [12] 中解决。此外, Hurwitz 定理引深的另一类问题是: 给定一个连通图, 以其为基础图的地图自同构群的最大阶是多少? 其对应的有极大对称性的地图有怎样的结构特征? 这一类问题的解决, 相信对深入研究 Riemann 曲面及地图的自同构群有意义。

2. 已知 Riemann 曲面上的一些特殊自同构群阶的上界, 例如, Harvey^[7] 和 Maclachlan^[11] 对于 Riemann 曲面上循环自同构群和交换自同构群的阶给出了估界, 其上界分别为 $2(2g(\mathcal{S}) + 1)$ 和 $12(g(\mathcal{S}) - 1)$, Chetia 和 Patra 在文献 [4] 给出了亚交换群阶的上界, 其对应的具有极大对称性的地图具有怎样的性质? 特别地, 他们是否都是对称地图? 这一类问题, 目前尚没有引起人们的重视。但采用组合方法去实现经典数学中的一些结论并从组合角度对其进行推广, 无疑是组合数学的一个重要的发展方向。

3. Klein 曲面包含 Riemann 曲面, 同时具有许多与 Riemann 曲面相似的性质, 例如, Klein 曲面的自同构也是有限的。注意定理 4.2 的证明中并没有用到地图的可定向性质, 故类似的方法可以得到对不可定向地图 $M, g(M) \geq 3$ 的自同构群, 有

$$|\text{Aut}^+ M| \leq 42(g(M) - 2)$$

和

$$|\text{Aut} M| \leq 84(g(M) - 2).$$

同时, 对任何一个不可定向曲面 $\mathcal{S}, g(\mathcal{S}) \geq 3$, 有

$$|\text{Aut}^+ \mathcal{S}| \leq 42(g(\mathcal{S}) - 2)$$

和

$$|\text{Aut} \mathcal{S}| \leq 84(g(\mathcal{S}) - 2).$$

同样, 其等号成立当且仅当其顶点次为 3, 面长为 7, 或反之, 顶点次为 7 而面长为 3, 且为不可定向的对称地图, 这类地图是否存在? 若存在是否与可定向情形类似, 有无限多个?

4. Bujalance 在文献 [3] 中给出了不可定向的 Klein 曲面上循环自同构的最大阶, 与 Riemann 曲面的情形类似, 进一步从组合的角度去研究其具有极大对称性的地图结构性质并用其刻画 Klein 曲面是有意义的一个问题。

参考文献

- [1] R.D.M.Accola, On the number of automorphisms of a closed Riemann surface, Tran.Amer.Math.Soc., vol.131,398-408(1968).

- [2] N.L.Biggs and A.T.White, *Permutation Groups and Combinatorial Structures*, Cambridge University Press (1979).
- [3] Emilio Bujalance, Cyclic group automorphisms of compact non-orientable Klein surfaces without boundary, *Pacific J. Mathematics*, vol.109, No.2, 279-289(1983).
- [4] B.P.Chetia and K.Patra, On metabelian groups of automorphisms of compact Riemann surfaces, *J.London Math.Soc*, Vol.33, No.2, 467-472(1986).
- [5] Hershel M.Farkas and Irwin Kra, *Riemann Surfaces*, Springer-Verlag New York inc(1980).
- [6] A.Gardiner, R.Nedela, J.Širáň and M.Škovera, characteristion of graphs which underlie regular maps on closed surfaces, *J.London Math. Soc.*(2)59(1999), 100-108.
- [7] W.J.Harwey, Cyclic groups of automorphisms of compact Riemann surfaces, *Quart J.Math. Oxford*, vol.17, No.2, 86-97(1966).
- [8] G.A.Jones and D.Singerman, Theory of maps on orientable surfaces, *Proc.London Math.Soc.* (3)37(1978), 273-307.
- [9] 刘彦佩, 数组合地图论, 科学出版社, 北京, 2001.
- [10] 刘彦佩, 组合地图进阶, 北方交通大学出版社, 北京, 2003.
- [11] C.Maclachlan, Abelian groups of automorphisms of compact Riemann surfaces, *Proc.London Math.Soc.*, vol.15, No.3, 699-712(1965).
- [12] A.M.Macbeath, Generators of the linear fractional groups, *Proc.Sympos.Pare. Math.*, XII(1969).
- [13] Kenji Nakagawa, On the orders of automorphisms of a closed Riemann surface, *Pacific J. Mathematics*, vol.115, No.2, 435-443(1984).
- [14] T.W.Tuker, Finite group acting on surfaces and the genus of a group, *J. Combin. Theory*, Ser.B34(1983), 82-98.
- [15] W.T.Tutte, What is a Map ?, in *New Directions in the Theory of Graphs*(ed. by F.Harary), Academic Press (1973), 309-325.
- [16] 伍鸿熙, 吕以鞏和陈志华, 紧黎曼曲面引论, 科学出版社 (1999)。

21math-001-010

我的数学之路*

毛林繁

(中国科学院数学与系统科学研究院, 北京 100080)

摘要: 依据时间的先后, 本文回顾了我由一个建筑工人成长为一个数学家的全过程, 包括中学时期、在一家建筑公司工作、在北方交通大学攻读博士学位, 在中国科学院从事博士后研究以及在国信招标有限责任公司工作等, 文中细致回顾了从 1985 年 -2006 年我从事科学研究的艰辛历程, 也回顾了一些研究成果的得到过程, 包括数学组合化猜想的提出过程。

The Mathematical Steps of Mine

Abstract: This paper historically recalls each step that I passed from a scaffold erector to a mathematician, including the period in a middle school, in a construction company, in Northern Jiaotong University, also in Chinese Academy of Sciences and in Guoxin Tendering Co.LTD. Achievements of mine on mathematics and engineering management gotten in the period from 1985 to 2006 can be also found. There are many rough and bumpy, also delightful matters on this road. The process for raising the combinatorial conjecture for mathematics is also called to mind.

关键词: 中学生、工人、工程管理、博士生、博士后、数学家、数学组合化猜想。

AMS(2000): 01A25,01A70

二〇〇五年五月三十一日上午 10:00 整, 中国科学院数学与系统科学研究院报告厅内, 我的“*On Automorphism Groups of Maps, surfaces and Smarandache Geometries*” (论地图、曲面及 Smarandache 几何的自同构群) 的博士后报告如期

¹2006 年 3 月 26 日为四川省万源市中学全校师生报告,

²e-print: www.K12.com.cn 和 www.wyszx.cn

举行。与此同时，美国 SNJ 杂志的主编 Perze 博士也在关注这次报告，此前，报告的内容已经过他修改过。听报告的，除国内组合数学界五位极有威望的教授外，还有一些研究生。当我报告到 *Map Geometries* 一段时，中国科学院研究生院党委书记，数学家颜基义教授举起了手中一张图，问我：“Iseri 的 Smarandache 几何模型在现实空间是可以实现的，网上这张图你看到过吗？”我说：“看到过，不仅看到过，而且研究过 Iseri 关于 Smarandache 流形的那本专著，这里定义的 *Map Geometries* 是他的空间模型的推广，由此可以依据组合论方法，特别是组合地图方法对经典数学及传统物理时空观进行重建与推广”。我的这种观点，立刻得到了国内组合地图学家、我的博士导师刘彦佩教授的首肯。

以上是我作博士后报告过程中的一个插曲。经过了二十余年的努力，我从一位建筑工人最终成为了数学家。过程中得到了许多国内外数学家的关心与支持，这其中包括中学时期一些数学老师对我在步入数学研究方面的影响。

(一) 中学时期

我是在原 103 工程指挥部设在四川省万源市（县）子弟小学完成的小学学业，于 1976 年毕业。当时由小学升初中采用的是分配制，父亲时任 103 工程指挥部设在万源县的预制加工厂厂长。记得小学毕业时厂里一共联系了三个学校，万源中学、万源镇中学和红旗公社学校，父亲率先作出表率，主动将自己的孩子分到了红旗公社学校念初中。这样，1976 年 9 月 -1978 年 7 月，我来到红旗公社学校读初中（两年制）。

记得当时教授数学的是王芳喜老师。正赶上陈景润对 Goldbach 猜想做出“ $1+2$ ”的贡献后，国内舆论界对其进行大力宣传时期，特别是徐迟的报告文学“哥德巴赫猜想”，使我对数学产生了极大兴趣。在进入初中学习后经常超前学习或预习，课余时间经常向数学老师请教一些数学问题。

家里当时正好有几本五十年代出版的初等代数、初等几何书，上面的习题比当时我们学习的教科书上的习题要难，题型也多。我在课余及假期大多时间都用来解答上面的习题。我在小学时很喜欢钓鱼，但进入中学后，基本上没有时间再去钓鱼，而将大部分时间用来学习，比如在初中第一学期将初一的数学课学完，第二学期则将整个初中数学课学完等。从初中第二年开始学习高中课程，这也是我在后来进入万源中学高中第一学期能够参加达县地区高中数学竞赛并拿到名次的原因。

1977 年参加全县初中联考，我数学得了满分 120 分。当时有一个有趣的插曲，就是负责判卷的老师认为数学试卷的标准答案有误，而我的解答是正确的，一致同

意给我满分。

我觉得初中数学学习除理解概念外，一定要多做习题，并通过习题进一步理解概念的内涵与外延，这也是整个数学的学习规律。但不一定要去做偏题与怪题，后者绝大多数是一些数学家在数学研究中的偶得，虽然采用初等数学的方法可以解决，但对中学生来说其技巧与方法的深刻内涵是难于理解的。

记得当时的初中同学有李再强、李文训、蔡小红等，他们均是学校附近农村的子女，再就是当时 103 工程指挥部预制加工厂的 5 位子弟，他们后来均在中国建筑第二工程局系统内工作。

初中毕业后参加全县升学考试，我获得了比较好的成绩。正好万源县将全县升学考试中的前 100 名考生汇总到万源中学学习，前 50 名集中在 1 班，51-100 名在 2 班，从而使得我有机会到万源县中学高 80 级 1 班学习。因为数学成绩突出，很得数学老师胡中生的欣赏，他不时给我讲一点课外题、特殊的解题方法等。并推荐我参加了 1979 年三月达县地区高中数学竞赛，获得了地区第 18 名的成绩。

高中时期我喜欢读一些数学课外读物，如许纯舫的《初等几何四种》、梁绍鸿的《初等数学复习及研究》、华罗庚的《从杨辉三角谈起》、严镇军的《从正五边形谈起》、高校通用教材《高等数学》（第一册）等。

1980 年 4 月我父母全家由万源县搬到河北唐山，参加唐山震后恢复建设。我参加完 1980 年高考后去的唐山。

高中时期的数学教育除教给学生基本知识外，更多地，应加强学生的数学素质教育，而这对任教的数学老师则提出了较高要求，即既要讲清概念、定理的内涵与外延，又要知道其提出目的、思路以及对更上一层数学的作用，这是比较难的。实际上，造成许多学生不喜欢数学的一个直接原因是教师在讲课时照本宣科，不能做到“深入浅出”，学生为应付考试“囫圇吞枣”式地学习，最后完成考试 60 分结束。对于学生来说，则需要多问几个为什么：为什么提出这个概念？为什么这样提出？有没有其他更好的提法？这个定理起什么作用？有没有更好的结果等等。同时，高中时期实际上也是学生进行人生立志的时期，这是教与学两个方面都应引起重视的问题。

(二) 建筑工人

1980 年 7 月底我由四川省万源县坐火车去唐山。在西安候车室的书店内买到陈景润写的《初等数论》(II)，到唐山后又购得华罗庚的专著《数论导引》。于是开始学习其中的部分章节，同时继续学习高等数学，并开始解答吉米多维奇《数学分析习题集》中一些习题。

1980年12月底参加工作，到中国建筑二局一公司当了一名架子工，参加当时全国最大的火力发电厂陡河电厂建设。因为上班很累，为赶工期又经常加班，晚上学习数学经常很晚。有一次在脚手架上差点睡着了，一位工人老师傅赶紧把我叫醒，因为那样实在太危险了。这以后，搭高一点的脚手架时，工人师傅一般不让我在上面搭架子，仅让我在地面递送脚手架材料给他们。

当时因读辽宁大学吴振奎老师（现为天津商业大学教授）编著的《初等数学计算技巧》一书并对其中部分内容提出自己见解，得到他的赞许。他也成了我在工人时期能够坚持学习数学的精神支柱。该书出版半年后，辽宁人民出版社让他找人写一份书评，应他的要求，我按照自己的理解对该书的特点、方法等对这本书进行了综合评述。

1983年6月我参加中国建筑二局一公司委托培养人员资格考试，获得第1名的考试成绩。

(三) 委培生

由于考取了单位的委培生，1983年9月至1987年7月我在北京城建学校工业与民用建筑专业建83-1班学习。这段时期是我进入数学研究的初级阶段。因在学校数学成绩突出，1985年应邀在《中专数学研究》上发表

(1) 傅氏级数、拉氏变换及RMI原则，中专数学研究，29-32,1 (1985)

(2) 学习数学的点滴体会，中专数学研究，22-23,2 (1985)

两篇文章。

从1983年10月起，经过吴振奎老师介绍，我在北京工业大学杨燕昌老师指导下系统学习高校数学专业的数学课程。这个时期先后学习了《数学分析》、《高等代数》、《近世代数》、《组合数学》、《图论》等课程，特别是图论，由他引导，我们一起学习由青海师范大学施容华老师（现南京理工大学教授）翻译的《极值图论》（匈牙利数学家Bollobas著），一起学完了前两章，对我后来从事图论研究，在技巧与方法上起到了奠基作用。在学习近世代数开始时杨燕昌老师为我先讲解了群论。他在桌子上摆放了三个不同的水杯，然后交换其中两个杯子位置，问：“这个过程在数学上怎样描述呢？”，于是他在黑板上写下 (123) 与 (132) 两个置换并说：“这就产生了群的概念”。由此使我突然理解了数学的本质，即来源于世界并服务于世界，也明白了在数学方法上这种由具体到抽象的过程，对我后来在数学研究中善于提出问题并寻找方法解决问题起到了直接作用。

有一天，杨燕昌老师拿来一篇发表在《新疆大学学报》上的论文“关于自中心

图中的几个定理”让我认真读一下，并对我说“书读到一定程度就差不多了，应该接触一些论文，从事一线数学的研究了”。

在杨燕昌老师的指导下，经过反复探索试证，我发现这篇论文的结果可以沿着几个方向进行推广，这样就陆续写出了三篇论文，但拿到学报上去均被退了回来。这当中有一篇论文的审稿人是施容华老师，他也知道了国内有我这样一个搞图论研究的青年，并来信勉励。他告诉我匈牙利著名数学家 Erdos 有个无三角形猜想，希望我能研究一下。经过几个月的研究，我得到了一个一般性结果，虽然没能彻底解决这个猜想，但考虑的问题已经比原猜想要广了。正好 1987 年“全国第五届图论学术交流会”在甘肃兰州召开，我想去参加这次会议，就把论文寄给了施容华老师。他推荐我参加了这次会议，并在会上对该结果进行了报告。

1987 年 11 月，由中国科学院计算中心屠规彰研究员介绍，我认识了国内著名拓扑图论家、后来成为我的博士导师的中国科学院应用数学所的刘彦佩教授。他建议我将这篇论文拿出去发表。正好这时《东北数学》有一篇关于组合恒等式的文章让屠规彰研究员审阅，他将论文转给了我进行审查。我审完后签上大名，编辑同志也因而知道了我这样一个人。这篇论文在《东北数学》上于 1990 年正式发表。

当时北京城建学校的老师都知道我喜欢数学，特别是中专前两年的课实际上在重复高中课，老师一般也不管我，使得我有充分的时间去北京图书馆查阅一些资料，去北京工业大学与杨燕昌老师一起讨论数学问题、参加国内学者举办的一些数学讨论班学习，比如 1986-1987 年，就先后参加了屠规彰研究员（现在美国）主持的“Kac-Moody 代数讨论班”、北京工业大学唐云教授（现清华大学教授）主持的“分叉理论及其应用讨论班”等。这些对于我今天能够站在一个比较广泛的角度看待组合问题起到了不小作用。

(四) 建筑技术管理

1987 年 8 月，我回到了中国建筑二局一公司，分在了该公司第三工程处生产技术股任技术员。日常业务主要是编写施工组织设计、施工方案和解决工程施工过程中出现的技术难题。

我在 1989 年-1991 年 8 月参加北京财贸学院一期工程建设管理；1991 年 10 月-1993 年 12 月升为技术队长，参加北京光彩体育馆等工程建设；1994 年 1 月-12 月任中国建筑二局一公司三分公司生产技术科科长，1994 年 3 月被破格晋升为工程师；1995 年 1 月-1998 年 9 月任北京电力生产调度指挥中心总工程师，该工程竣工后被评为国家“鲁班奖”工程；1998 年 10 月-12 月任中华民族园项目总工程师。

这一个时期数学研究曾一度中断过。曾一度以攻克施工技术难题为己任，比如

对国内倒锥壳水塔水柜顶升施工技术的研究、对大型蓄水池结构抗渗技术的研究等。先后在工程施工管理中解决过不少重大的技术难题，并开始在国内施工领域发表建筑技术论文。先后在施工技术、施工质量和安全管理方面发表了十多篇论文，并应邀参加了《建筑工程施工组织设计实例应用手册》和《建筑工程施工实例手册》第2册和第7册的编写。

虽然如此，学习数学、拿到数学类本科文凭的想法并未放弃。意外得知北京市有应用数学专业本科的自学考试，于是从1991年4月开始参加北京市高等教育自学考试，到1995年6月完成毕业答辩，拿到北京大学颁发的应用数学专业本科文凭和学士学位。

这一时期也在参加国内的一些学术会议。1988年在天津南开大学参加“首届中国组合最优化国际讨论会”；1989年在山东青岛参加“全国第六届图论学术交流会”等。

1993年中期，杨燕昌老师来信，让我与他一起于1994年8月去太原参加“全国第八届图论学术交流会”，这样我又将搁置了近4年的数学研究重新拾起来。我这时的兴趣已经转到了 hamiltonian 图的研究上。经过对1991年发表在国际图论杂志上 Gould 教授一篇综述文章的学习及相关论文的研读，我陆续完成了一批关于 hamiltonian 图的论文，分别在《太原机械学院学报》、《数学研究与评论》等杂志上发表。

参加“全国第八届图论学术交流会”的同时，我认识了杨燕昌老师的大学同学，北京大学的徐明耀教授，他是国内代数图论的带头人。他的一个观点至今仍然影响着我，就是“必须多读书，多读专著，这样才能搞出大成果”。



1989年参加“全国第六届图论学术交流会”（山东青岛）
与常安教授（现福州大学）合影



1994 年参加“全国第八届图论学术交流会”（山西太原），在阎锡山故居留影

这个时期先后在《东北数学》、《数学研究与评论》、《纯粹数学与应用数学》等学术期刊上发表了 5 篇数学论文。

1994-1998 年我在北京电力生产调度指挥中心工程担任总承包总工程师。博士阶段发表的关于 hamiltonian 图的一些论文实际上是在这一时期完成的。“是一边听着震捣棒的响声，一边写作完成的”。当时曾有不少关联单位找到我，希望我去他们那里工作，考虑到家庭原因均没去。一次偶然的的机会，在北京大学见到博士生招考目录，发现代数组合论方向的考试科目我均学过，有的还发表过论文。于是个人产生一种奇想：直接以同等学历的身份去攻读博士学位。

这样从 1996 年起，我的学习以通过博士生入学考试为目标，最终于 1998 年考取了北方交通大学理学院刘彦佩教授的博士生。

(五) 攻读博士学位

1999 年 4 月，我进入了北方交通大学学习，开始了我的博士生生涯。除第一年外，整个学习并不感觉紧张。这时我的工作关系还在中国建筑二局一公司。他们不支持我的学习，无任何生活津贴。这样除学习外，还需要去打工挣钱以满足家庭开支。1999 年 1 月 -2000 年 6 月，我担任中国法学会基建办公室总工程师；2000 年 7 月 -2002 年担任国信招标有限责任公司项目经理。生活平添不少乐趣，也建立了个人能够同时开展两种思维方式，从事两种工作的生活习惯。

在北方交通大学刘彦佩教授指导下，我在原来图论基础上，开始了拓扑图论及组合地图的学习与研究。因来交大之前我受北京大学徐明耀教授工作的影响比较偏重代数，在进入博士阶段学习的第二年就采用群论方法做出了一个关于组合地图计数的好结果，得到了导师的赞许。这个结果后来在《数学物理学报》上发表。

如何采用数学工具去解决实际工作问题，是从事应用数学的人首要须进行训练

的。2001年，我们几个同学同时选择了交通学院高自友老师的“运筹学在交通运输规划中的应用”的课程，经常是晚上去上课，又赶在冬季下雪，每次都有缺课的同学，但好处是不用考试，直接写一篇课程论文。听完课后，我采用图论的方法，结合他的课程写了一篇关于公共交通可靠性的论文交了上去，当时也没觉得怎样，就是完成一门课程而已。到期末时，我的几个同学惊奇的告诉我得了90分，说一般同学得到80分就很不错了，他仅给他自己两个专门学交通规划的博士生90分成绩，而我则是学数学的。在同学的鼓励下，我觉得这篇论文可以拿到国内一级交通学报上发表，这样就寄给了《中国公路学报》，结果在第二年就发表出来了。要知道，就是专门学交通的学生在上面发表文章也是比较困难的。

由于在读博士前已经有了十多年的知识积累和研究训练，整个博士论文“A census of maps on surfaces with given underlying graphs”(论曲面上给定基础图的地图)是按照我自己的思维方式写出来的，主要采用群作用理论对曲面上组合地图进行分类、计数研究，这在国际上也是处在前沿的。论文完成后交给国内10位教授评审，结论均为优秀。

这当中有一个有趣的插曲，担任博士论文答辩委员会主席的是国内著名数学家、中国科学院的越民义教授。在答辩前20天，他告诉刘彦佩教授说审核不了我的论文、看不懂，让刘彦佩老师重新找人审查，这样原定的答辩就无法如期进行了。我找到了越民义教授，将我在博士论文中采用的方法、技巧与创新、得到的主要结论及国际上在这方面的进展等等向他进行了详细的介绍。老先生听后，沉思了一会，认为我的思路和方法较之刘彦佩教授以前指导的几个学生有很好的创新，结论有一定理论价值，于是欣然写下了对论文的评语，并就组合优化领域对我提出一些研究建议。



博士论文答辩留影

左起李赵祥、毛林繁、何卫力、郝荣霞、魏二玲

(六) 博士后研究

我自己觉得博士论文中还有许多问题及想法需要进一步实现，也需要一定的环境及时间去实现，这样在博士毕业后开始联系单位做博士后。



2002 年参加“世界数学家大会组合卫星会议”（石家庄）
左起王广选、魏二玲、任韩、何卫力、万良霞、毛林繁

2002 年 11 月，在北京大学徐明耀教授主持的讨论班上，我作了“*A dynamic talk on maps and graphs on surfaces—my group action idea*”（关于地图与图在曲面上的嵌入的一个报告 - 我的群作用观点）的综合性研究报告，以期得到国内同行的广泛共识。

2002 年底，中国科学院数学与系统科学研究院接受了我的博士后申请，并确定于第二年初开始博士后研究工作。由于北京 2003 年初“非典”影响，我直到 2003 年 6 月才进入中国科学院数学与系统科学研究院开始研究工作。合作导师田丰研究员，是国内图论研究工作的奠基人之一。他个人主要从事结构图论的研究，我在读博士前的许多关于 hamiltonian 图的研究工作均受他的影响。

第一次见面，田丰老师就对我说：“你们刘老师作的那些研究工作，我不懂，你自己干吧”。这使得我有充足的时间将博士阶段没有研究完的工作研究完，同时依据个人想法开展新的研究领域。这也使得我可以跳开导师的思路，从而做出一些新的研究工作。事实证明这条路是对的。应他的要求，我在中国科学院数学与系统科学研究院作了首次报告：“*Active problems in maps and graphs on surfaces*”（地图与

图在曲面上的嵌入中一些活跃的问题)。



上图说明：2004年8月参加“全国第一届图论与组合数学学术交流会议”（新疆乌鲁木齐）与李晓东合影（参加全国第五届图论学术交流会时我们住在一间屋内，当时我还是一个工人），这次见面他说我的变化最大，已经在科学院从事研究工作了。

博士毕业以后，我一直在想，刘彦佩老师在国内主持了几十年的拓扑图论有什么用？它对数学有哪些贡献？这两个问题也是国内许多同行经常问我的问题，因为刘彦佩老师的许多科研工作国内的人看不懂。于是，把刘彦佩老师的方法用到其它数学领域，让更多的人了解这种方法，从而推广到其他领域做出一些大的科研成果就成了我在博士后阶段工作的重点。

为此，我在中科院期间研读了大量的非组合、图论方面的专著，如大范围微分几何、黎曼曲面、黎曼几何、代数曲线、克莱因曲面等等，并开展了相关研究。第一篇论文完成后，正好召开“第二届中国科学院博士后前沿与交叉学科学术论坛”，就交给了他们出版。

按照我博士后的主攻方向，我在2005年4月完成的博士后报告“*On Automorphisms of Maps & Surfaces*”已经不是纯组合或图论方向的论文了，它实际上已经参杂了我的许多新论点，这种论点支持着我的一种观点，就是在组合数学家看来，任何一门数学学科均可以进行组合化或进行组合重建。这种观点在我的博士后报告中仅开了个头，有大量的工作需要去做。博士后报告的最后一章就是在我的知识范围内，例举微分几何、黎曼几何中许多采用组合方法需要去进一步研究的数学问题。

2005年6月我参加了2005图论与组合数学暨第三届海峡两岸国际学术交流会，并作了“An introduction on Smarandache geometries on maps”的报告。这篇报告与我在中国科学院作的博士后报告“On Automorphism Groups of Maps, Surfaces and Smarandache Geometries”后来成为了国际互联网百科全书上解释 Smarandache 几何 6 篇引用文献中的两篇参考文献。

博士后报告完成后，我觉得应该拿出去出版，把我对组合数学的这种观点向世人公布。正好在 2005 年初，美国有一家出版社向我约书稿，我就把博士后报告发给了他们。他们很欣赏我的观点，建议我在报告中增加有关 Smarandache 几何的内容。经过增加及修改，该书于 2005 年 6 月在美国 American Research Press 出版社正式出版。

(七) 新数学的展望

博士后研究结束后，应我的要求，国家人事部将我直接分配回了国信招标有限责任公司。并征得中国科学院数学与系统科学研究院的同意，我仍然作为他们那里的研究人员从事研究工作。之所以选择这条路，一是我也不想将我在工程建设领域多年积累的经验与知识放弃（每年我在全国各地应国家部委或省市主管部门均有一些关于工程管理的讲座，听众大多为政府官员）；二是目前国内的科研体制问题，特别是科技产业化思想的影响，使得基础科学研究急功近利，不去做也不可能做出一些大成果。国内目前的科研体制直接造成了科研工作者以追求论文数量、论文的检索级别，不愿意做也不可能去进行一些开创性的大的研究工作。按照科学研究的规律，开创性的研究一般需要 5-10 年的时间才能发表出论文，在国内，这样的科研人员早就被炒鱿鱼了。在这种急功近利思想影响下，在企业与在科研机构从事数学研究实际上是一样的。我个人的解释是“用在企业挣的钱去发展我的数学研究，走一条数学研究的新路”，这种观点，得到了中国科学院数学与系统科学研究院的支持。

需要特别指出的是，美国几位朋友让我在博士后报告中增加的内容，是国际数学研究上一个新的突破点，由此可以使得数学知识创新犹如宇宙大爆炸时代一样飞速发展。而我在博士后阶段的一些观点正好与他们的想法不谋而和。目前这方面已经有的工作并不多，我已经走到了前沿。我那本书送给了国内许多同行，均获得好评。美国 Perze 博士评价说“*Your book is very good. High research you have done.*”；华东师范大学一位教授评价说书的范围广，“范围很广，很大度”。

但更多的是需要让国内外同行了解我的思想和这个欣欣的方向。于是在 2005 年，我在北京的几所大学、中国科学院数学与系统科学研究院以及国内的一些学术会议上，对我的这种数学组合化观点及一些研究工作进行了报告，获得了一致好

评。Scientia Magna 杂志一次就将我在 2005 年做得两次报告、两篇论文进行全文收录发表。

结合我的组合论及 Smarandache 几何思想,我发现可以对传统数学进行大范围的推广与组合,从而引发了许多新的数学问题。这样在与美国朋友通信后,应邀开始新的研究工作及写作,标题是“*Smarandache Multi-spaces Theory*”(Smarandache 重叠空间理论),对传统代数、几何理论及物理时空观,采用我的组合观进行新的研究与重建。

我个人的宇宙观是大千世界有许多个宇宙,有的相互分离,有的则相互交叉。由于地球人类的人体构造原因,地球人类要想认识清整个宇宙是一件很困难的事,因为地球人类看不到的太多太多了。我们这个宇宙的维数是 3,与其它宇宙空间有部分交叉,交叉的其它空间维数可能是 3,也可能大于 3。这样,在这些宇宙中的部分物质占据我们这个宇宙的质量,但我们看不到它们,因为它们不处在我们看得到的 3 个维以外的方向上,这就是暗物质。关于暗物质,我的观点是地球上的人类不可能找得到,因为它们不处在我们观测得到的方向维上。处在高维空间中的智能生物应该比地球上人的智商要高,因为它们处的空间维数比地球人的高。在这点上,我不同意目前流行的那种认为地球人类可以通过地球实验方法找到暗物质的观点。

从理论上讲,Smarandache 几何包含 Riemannian 几何,从而包含爱因斯坦广义相对论,但如何实现则一直没有途径。而我发现采用我的组合论观点,则可以对其、包括量子力学许多内容进行重建与推广。这本书已于 2006 年 3 月在美国出版。美国朋友在网站上公布了这本书,可以免费全文下载。

2006 年 8 月,我参加了第二届全国组合数学与图论大会,在这次会上,我对我的数学组合化猜想及得到的代数、几何以及组合方面的一些结果进行了报告,得到了与会者的一致好评,给与会者一个重要的启示,那就是在中国需要走一条数学组合化的发展道路。而这也许正是使中国成为数学强国的一条必经之路。

(八) 家庭成员

任何一个成功的科研工作者都离不开家人的支持与关心,我也不例外。我于 1990 年在北京结婚,女儿 1993 年初出生。在二十多年从事数学学习与研究的过程中,得到了来自各个方面的关心。父亲在我记事起刻苦自学的行为对我产生过深深的影响,而家庭成员的理解更是对我走上数学研究道路起到了不可磨灭的作用。



2004年8月与妻子和女儿在新疆乌鲁木齐留影

以上是我从一位普通建筑工人经过多年的艰辛努力最终走上数学研究的不平凡之路。过程虽然曲折与坎坷，但更多地则是人生价值的体现。在这一个过程中，许多老师，包括中学阶段的老师，对我走上这条人生道路起到了不可磨灭的促进作用。我想，这应该也是整个教育的规律。

附录：毛林繁分年论文目录

1985年

1. 傅氏级数、拉氏变换及 RMI 原则，中专数学研究，29-32,1 (1985)
2. 学习数学的点滴体会，中专数学研究，22-23,2 (1985)

1990年

1. The maximum size of r -partite subgraphs of a K_3 -free graph, 东北数学, 4 (1990), 417-424.

1992年

1. 北京财贸学院 100m³ 水柜顶升施工，滑模工程，1 (1992)
2. (与马刚合著) 北京木樨园体校 50m 标准游泳池结构抗渗施工，建筑科技，4 (1992)

1993 年

1. (与马刚合著) 北京木樨园体校 62m 无粘结预应力混凝土大梁施工, 建筑科技, 1 (1993)

1994 年

1. (与杨燕昌合著) $R(G)=3$ 的自中心图的圈结构研究, 纯粹数学与应用数学, vol 10 (增刊) (1994), 88-98.

2. Hamiltonian graphs with constraints on vertices degree in a subgraphs pair, 太原机械学院学报, vol 15 (增刊) (1994), 79-90.

1995 年

1. (与马刚合著) 北京木樨园体校游泳池抗渗混凝土结构施工, 建筑技术, 5 (1995)
2. 游泳池结构抗渗施工技术, 中国实用科技成果大词典 (95 版), 1995.
3. 采用大吨位滑模千斤顶从事水柜顶升施工技术, 中国实用科技成果大词典 (95 版), 1995.

1996 年

1. 有给定半径自中心图的最大边数, 西安电子科技大学学报, vol 23 (增刊) (1996), 6-10.
2. 混凝土涨模原因分析及防治, 建筑科技, 2 (1996).

1997 年

1. 怎样编写高层建筑施工安全防护方案, 建筑安全, 11 (1997)

1998 年

1. A localization of Dirac's theorem for hamiltonian graphs, 数学研究与评论, vol.18, 2(1998), 188-190.
2. 混凝土涨模原因分析及防治, 建筑技术, 9 (1998)
3. 怎样编写高层建筑施工安全防护方案, 建筑科技, 1 (1998)

1999 年

1. 学校一期工程施工组织总设计, 彭圣浩主编: 建筑工程施工组织设计实例应

用手册, 中国建筑工业出版社, 1999。

2. 游泳池工程施工组织设计, 徐家和主编: 建筑工程施工组织设计实例应用手册, 中国建筑工业出版社, 1999。

3. 北京木樨园体校游泳池抗渗混凝土结构施工, 中国建筑工程总公司编: 建筑工程施工实例手册(2), 中国建筑工业出版社, 1999。

2000 年

1. 局部化 Fan 条件的一个推广, 曲阜师范大学学报(自然科学版), vol 26, 3(2000), 25-28。

2. 北京电力生产调度中心施工质量控制与管理, 建筑科技, 2 (2000)。

3. 北京电力生产调度中心装饰工程施工, 建筑工程施工实例手册(7), 中国建筑工业出版社, 1999。

2001 年

1. (与刘彦佩合著) 哈密尔顿图的一类新的局部化充分条件, 曲阜师范大学学报(自然科学版), vol 27, 2(2001), 18-22。

2. (with Liu Yanpei) On the eccentricity value sequence of a simple graph, 河南师范大学学报(自然科学版), 13-18, 4(2001)。

3. (with Liu Yanpei) An approach for constructing 3-connected non-hamiltonian cubic maps on surfaces, *OR Transactions*, 1-7, 4(2001)。

2002 年

1. *A census of maps on surfaces with given underlying graphs*, A Doctorial Dissertation, Northern Jiaotong University, 2002。

2. On the panfactorial property of Cayley graphs, 数学研究与评论, 383-390, 3 (2002)。

3. 城市公交网络可靠性的双层规划模型, 中国公路学报, 88-91, 3 (2002)。

4. Localized neighborhood unions condition for hamiltonian graphs, 河南师范大学学报(自然科学版), 16-22, 1(2002)。

2003 年

1. (with Liu Yanpei) New automorphism groups identity of trees, 数学进展, 113-117, 5(2002)。

2.(with Liu Yanpei)Group action approach for enumerating maps on surfaces, *J. Applied Math. & Computing*, vol.13, No.1-2,201-215.

3. (与刘彦佩合著)图的可定向嵌入的标根可数性, 数学物理学报,287-293,3 (2003)。

4. (与刘峰合著) 顶点距离 ≥ 2 的局部化条件与哈密尔顿图, 河南师范大学学报 (自然科学版),17-21,1(2003)

2004 年

1. (with Yanpei Liu)A new approach for enumerating maps on orientable surfaces, *Australasian J. Combinatorics*, vol.30(2004), 247-259.

2. (与田丰合著) Riemann 曲面上 Hurwitz 定理的组合推广, 中国科学院博士后前沿与交叉学科学术论坛论文集, 2004 年 12 月,75-89。

2005 年

1.(with Feng Tian)On oriented 2-factorable graphs, *J.Applied Math. & Computing*, vol.17, No.1-2. 25-38.

2.(with Liu Yanpei and Tian Feng)Automorphisms of maps with a given underlying graph and their application to enumeration,*Acta.Math.Sinica*, Vol.21, 2(2005), 225-236.

3.On Automorphisms of Maps and Klein Surfaces,中国科学院博士后报告, 2005.6.

4.A new view of combinatorial maps by Smarandache' notion, e-print: *arXiv: math.GM/0506232*.

5.*Automorphism Groups of Maps, Surfaces and Smarandache Geometries*, American Research Press, 2005.

6.On automorphism groups of maps, surfaces and Smarandache geometries, *Scientia Magna*, Vol.1(2005), No.2,55-73.

7.Parallel bundles in planar map geometries, *Scientia Magna*, Vol.1(2005), No.2,120-133.

8.On algebraic multi-ring spaces, *arXiv:math.GM/05010478*.

9.On algebraic multi-vector spaces, *arXiv:math.GM/05010479*.

2006 年

1.with Yanpei Liu and Erling Wei) The semi-arc automorphism group of a graph with application to map enumeration, *Graphs and Combinatorics*, Vol.22,

No.1(2006)93-101.

2. *Smarandache Multi-Space Theory*, Hexis, Phoenix, American 2006.

3. 中国工程建设项目施工招标技巧与案例分析— Smarandache 重空间招标模型, Xiquan Publishing House, 2006.

4. On algebraic multi-group spaces, *Scientia Magna*, Vol.2, No.1(2006), 64-70.

5. On multi-metric spaces, *Scientia Magna*, Vol.2, No.1(2006), 87-94

6. 理论物理引发的二十一世纪数学— Smarandache 重空间理论, 中国科技论文在线: 200607-91.

7. 招标评价体系的数学模型及求解分析, 中国科技论文在线: 200607-112.

8. Combinatorial speculation and the combinatorial conjecture for mathematics, *arXiv: math.GM/0606702* and *Sciencepaper Online:200607-128*, will also appear in *Scientia Magna*.

9. A multi-space model for Chinese bidding evaluation with analyzing, *arXiv: math.GM/0605495*, will also appear in *Scientia Magna*.

10. Smarandache 重空间及相关数学组合理论, 见易媛、亢小玉编《Smarandache 问题研究》, High American Press, 2006.



作者简介

About the Author

Linfan Mao is a researcher in the *Chinese Academy of Mathematics and System Science*, also a consultant in the Guoxin Tendering Co., Ltd, in Beijing. His main interesting focus on *Smarandache geometries with applications to other sciences, combinatorial map theory and differential geometry*. Now he has published more than 35 papers and 2 monographs on Smarandache geometries, combinatorial maps, graphs and operation research.

He was born in December 31, 1962 in Deyang of Sichuan in China. Graduated from Sichuan Wanyuan School in July, 1980. Then worked in the *China Construction Second Engineering Bureau First Company*, began as a scaffold erector then learnt in the *Beijing Urban Construction School* from 1983 to 1987. After then he came back to this company again. Began as a technician then an engineer from 1987 to 1998. In this period, he published 8 papers on *Architecture Technology*, also the co-author in three books on architecture technology and 5 papers on *Graph Theory*. He got his BA in applied mathematics in Peking University in 1995 learnt by himself.

In 1999, he leaved this engineering company and began his postgraduate study in the *Northern Jiaotong University*, also worked as a general engineer in the *Construction Department of Chinese Law Committee*. In 2002, he got a PhD with a doctoral thesis *A census of maps on surface with given underlying graphs* under the supervision of Professor Yanpei Liu. From June, 2003 to May, 2005, he worked in the *Chinese Academy of Mathematics and Systems* as a post-doctor and finished his post-doctor report: *On Automorphisms of maps, surfaces and Smarandache geometries*. Now he is a researcher in the *Chinese Academy of Mathematics and Systems*.

Abstract: The mathematics of the 21st century is the combinatorization with its generalization for classical mathematics, also a result for mathematics consistency with the scientific research in the 21st century. This collection contains 10 papers finished by the author or the author with other mathematicians for introducing mathematics of the 21st century, including the combinatorial conjecture for mathematics, Smarandache multi-spaces, map geometries, enumeration of maps and a application of multi-spaces to bids evaluation system in China, which can be seen as a combinatorial speculation for classical mathematics, are also benefit for researchers working in mathematics of the 21st century.

中文摘要 二十一世纪数学是经典数学的组合化及其推广后的产物，也是为适应二十一世纪科学交叉组合发展的产物。为介绍二十一世纪数学的起源及发展，本文集包含作者本人及作者与其他数学工作者完成的 10 篇数学论文，涉及 Smarandache 重空间理论、地图几何、地图计数以及重空间理论在建立中国招标评价体系数学模型方面的应用，可以看作是对经典数学的组合思考，对那些有志于数学创新并服务于科学研究的人不无益处。

