

# New conceptual foundations for Quantum-Gravity and Quantum-Mechanics

**B N Sreenath**

*P B No 20,HPO, Shimoga-577201, Karnataka, India.*

*e-mail: bnsreenath@yahoo.co.in*

*Abstract.* Quantum-Gravity (QG) is limited to bodies, which have attained their ‘gravitational radius’ like Black holes (BH) and Quasars. QG has been explained and solved on entirely new concepts and laws so as to bring within its scope not only unification of all physical interactions including gravitation in its ‘distorted’ form and electro-magnetism but also other cosmological problems which involve high energy existence like the BH dynamics, dark-energy, etc. This becomes obvious once we go through the BH Chart and the Interaction-Table (IT). In BH Chart and the IT, gravitational radius and the interaction-range are identified thus unifying the phenomena occurring in BH with those of the micro-world. The two laws of QG enunciated give rise to two fundamental constants in physics whose values are reciprocal to the values of ‘C’ and ‘G’. The Quantum-Gravity field is identified with the “Exponentially Varying Accelerated (or Gravity) Field” so that in it both test masses of classical size and micro-particles of quantum size, describe the same ‘Logarithmic Spiral Path’. Micro-particles can also describe ‘Conical Spiral Path’. Thus QG field is an ‘inward spinning field’ which involves ‘Torsion’ and ‘Curvature’ varying. ‘Spinors’, which are used to describe the “Logarithmic Spiral Path” in BH, give rise to “Immirzi Parameter”. From the concept of ‘unitary change in acceleration’, atomic transitions are explained and ‘Heisenberg’s Principle of Indeterminacy’ is derived.

PACS: 98.80.Qc, 97.60.Lf, 96.50.Pw, 98.54.-h, 95.36.+x, 95.35+d., 95.30.Dr, 12.60.-i, 12.15.-y.

Key words: Black holes, Quasars, Exponentially Varying Accelerated Field, Rate of change of acceleration, Black hole chart, Interaction table, Logarithmic spiral, Unification of Interactions.

## Contents.

<b>1. Introduction</b>	3
<b>Part 1. Quantum-Gravity.</b>	
<b>2. The Laws of Quantum-Gravity.</b>	5
2.1. The First Law.	5
2.2. The second Law.	5
2.3. Implications of the laws of Quantum-Gravity.	6
2.3.1. The First law.	6
2.3.2. Implications of the second law of Quantum-Gravity.	8
2.4. Proof of the second law of Quantum-Gravity.	10
<b>3. Unification of Physical Interactions.</b>	11
3.1. The First Step towards Unification of All Four Physical Interactions.	11
3.1.1. <b>Table 1.</b> Black-Hole chart (BH Chart).	12
3.2. Major Step towards Unification of All Four Physical Interactions.	13
3.3. Interaction Table.	14
3.3.1. The Role of concepts 'r' and 'β' in IT.	15
3.3.2. Interaction Table. <b>Table 2.</b>	19
Table 3.	20
Table 4.	21
3.4. Final Step towards Unification of All Interactions.	22
<b>4. Black Hole Dynamics or Quantum-Gravity Field.</b>	<b>25</b>
<b>5. The Nature of the Quantum-Gravity Field.</b>	33
5.1. Logarithmic Spiral (LS).	34
5.1.1. Mathematical and Geometrical Description of LS.	35

<b>6. Geometry of QG Field (Geometry of LS).</b>	37
6.1. Application of Spinors to QG field and the derivation of the Immirzi-Parameter.	38
6.2. Application of Tensors to QG field (or LS path).	39
6.3. Reduction of the basic QG field (or EAVF) equation in to Einstein's basic gravitational field equation.	42
6.4. Relation between Schrodinger's equation and the acceleration of the QG field (or of EAVF) in tensors.	43
6.5. Relation between the basic equation of the QG and Schrodinger's equation of QM	44
6.5.1. The meaning of ' $\chi$ ', the Einstein's constant of the gravitational field.	47
<b>Part 2. Quantum Mechanics.</b>	48
<b>7. Exponentially Varying Accelerated Field (EAVF).</b>	48
7.1. Field Involving Unitary Change in Acceleration.	48
7.1.1. The meaning of $\hbar^2$ .	54
7.2. A comparison between the force acting on a particle and it's (particle's) Inertial force ( $f_i$ ).	55
7.3. Basic Equation Governing Atomic Energy Transitions And Its Relation To Exponentially Varying Accelerated Field.	56
7.4. Conversion of basic Equation of Atomic Energy Transitions in to its Exponential Form.	59
<b>Table 5.</b>	60
<b>8. The Heisenberg's Principal of Indeterminacy (HPI) and Quantum-Gravity (QG).</b>	61
8.1. Derivations of the equations of HPI from the relations of EAVF.	63
8.2. Measurement of Indeterminacy values of $\Delta P, \Delta x, \Delta E$ and $\Delta t$ .	64
<b>9. Conclusion.</b>	65
<b>References.</b>	65

## **1. Introduction.**

This article consists of two parts. The first part exclusively deals with the problem of *Quantum-Gravity* and the second part deals with *Quantum Mechanics* on the basis of new concepts framed. Let us consider the first part first.

All the problems and perplexities pertaining to Black-hole dynamics, unification of all the four physical Interactions, Dark-Matter, Dark-Energy, etc., can be easily explained if we, in addition to Newton's Universal law of gravitation, accept the following two laws of Quantum-Gravity (QG); one relating to the Force of Quantum- Gravity and the other one relating to its Energy.

It is necessary to discuss the background behind these two laws of Quantum Gravity and also to clarify the meaning of the concepts involved, especially in the second law relating to Energy. The first law relating to Force of Quantum-Gravity has been formulated to bodies, which have attained their 'Gravitational radius' i.e. for Black holes, Quasars, etc. so that in them the force of Quantum- Gravity exists. This law involves a new constant that is too closely related to the well-known Newton's Gravitational constant 'G'.

To comprehend the significance of the second law relating to energy, our conception of "Acceleration" has to under go a profound change. As it is evident from the history of science that if new facts are to be comprehended and new theories are to be constructed either, the existing concepts and premises have to be modified or replaced by entirely new ones. It is also well known that many of the concepts which are valid in the micro (or quantum) world may have no analogue in the macro (or classical) world and vice-versa is equally true. Now coming to the concept of "acceleration", it is defined as "the rate of change of velocity" in classical physics and has been accepted so in the quantum physics. But this acceptance of the definition of acceleration as "the rate of change of velocity" in quantum world has 'no' justification and hence 'unacceptable' if we are to frame the Second law of Quantum Gravity. For this, it is

essential to arise above the partisan level in order to develop the theory of Quantum Gravity.

The new concept of acceleration, which has been envisaged in the second law of quantum gravity, is central to the theory of quantum gravity and instrumental in developing it.

After enunciating the laws of Quantum Gravity, their implications and relations to some basic equations of physics are given. The proof of the second law of Quantum-Gravity is given.

Based on these laws, the Black-hole chart is presented which involves the quantum gravity energy. In the next section, unification of all four physical interactions is discussed on the basis of the Interaction-Table (IT). Before presenting the IT, some new concepts are introduced and incorporated into the IT. IT also gives decay times of various elementary particles and it represents them as their chart.

In the next section, the nature of Quantum Gravity field in Black Holes is discussed and it is geometrically interpreted. Quantum Gravity field is conceived in a way similar to the Electro-magnetic field conceived by Maxwell. First the concept of spinors is applied to the QG field and it gives the value of the Immirzi-parameter; then tensors are applied to it and it gives a *constant value* for coiling or uncoiling of all BH and Quasars irrespective of their masses.

In the *second part*, which deals with *Quantum Mechanics* (QM), exponentially varying Accelerated Field (EVAF) is discussed to bring within its scope the Electro-Magnetic field also. Atomic and Molecular transitions are brought within the concept of *unitary change* in acceleration. For this, a few new concepts are introduced and without them it is not possible to develop the theory of EVAF. So atomic transitions are explained on the basis of the exponential law. Finally, the “Heisenberg’s principle of Indeterminacy or uncertainty” which is at the core of quantum mechanics is derived on the basis of the equations of EVAF.

## Part 1. Quantum-Gravity

### 2. The Laws Of Quantum Gravity

#### 2.1. The First Law:

The force of quantum gravity is directly proportional to the product of the two masses and inversely proportional to the square of the distance between them:

$$\text{i.e. } F_Q = \check{G} (Mm/2R^2) \quad (1)$$

Where  $F_Q$  = Force of quantum gravity operating from the center of mass 'M' to its event-horizon (or surface) where the particle of mass 'm' is present.

M = Mass of the body which has attained its gravitational radius 'R' i.e. 'R' is the radius of the Black-hole (BH), Quasar etc.

m = Mass of the particle (micro) which has manifested itself at the surface of the black-hole of mass 'M'. Due to the gravitational interaction free energy is available at the surface of the Black Hole and 'm' is the mass corresponding to that free energy according to the relation  $E = mc^2$ .

$\check{G}$  = Constant of Quantum Gravity and  $\check{G} = 1.5 * 10^7 \text{ cm}^3/\text{gm. Sec}^2$  in CGS units.

The mark '\*' represents the multiplication sign. Thus the value of  $\check{G}$  is reciprocal to the value of 'G' the Newtonian Gravitational constant, and having the same dimensions of 'G'.

$$\therefore \check{G}G = 1(\text{Cm}^3/\text{gm. Sec}^2)^2 \text{ and } \check{G}/2G \approx 10^{14}.$$

#### 2.2. The Second Law:

The acceleration (or gravity) is '*quantized*' and quantized acceleration (or gravity) is equivalent to "quantum of energy".

i.e. if ‘a’ is the acceleration possessed by a particle or ‘g’ is the gravity (surface) of a Celestial body and ‘E’ is the quantum of energy corresponding to that then ‘E’ is proportional to ‘a’ (or ‘g’). i.e.

$$E = ka \quad \text{or} \quad E = kg \quad (2)$$

where ‘k’ is the quantizing constant of acceleration or gravity. It is also a fundamental constant like  $\check{G}$ , C,  $\hbar$ , G, etc. The value of  $k = 3.15 * 10^{-17}$  gm.cm in CGS units or in terms of energy in electron-volt (ev),  $k = 2*10^{-5}$  ev/cm/sec<sup>2</sup>. Its dimensions are mass \* length.

This energy is also expressed in the form of Kinetic Energy (KE) of the particle as acceleration is inevitably related to motion. From the equation (2), it is clear that if the acceleration (or gravity) remains uniform, the quantum of energy possessed by the particle corresponding to that also remains uniform. That is the Kinetic Energy possessed by the particle remains uniform in uniform accelerated (or gravity) field. In other words “There is no change in the Kinetic Energy of the particle if there is no change in its acceleration. Hence “Change in Kinetic Energy (and hence change in velocity) implies change in acceleration and vice-versa, in micro world”. This is the reason why acceleration cannot be defined as “the rate of change of velocity in the quantum (micro) world”. “Acceleration” is synonymous with “quantum of energy” in the micro world.

### 2.3. Implications of the laws of Quantum Gravity.

2.3.1. 1<sup>st</sup> Law: Since the law is applicable to bodies that have attained their gravitational radius like Black holes, the 1<sup>st</sup> law,  $F_Q = \check{G} (Mm/2R^2)$  may be written as

$$F_Q = (\check{G}/2G)(mC^2/2R) \quad (3)$$

Because, for Black holes,  $M/R = C^2/2G$ . The factor  $\check{G}/2G$  is a dimension-less number and equal to about  $\approx 10^{14}$ .

$$\therefore 2F_Q R = (\check{G}/2G) mC^2 = 10^{14} mC^2 = 10^{14} E_N = E_Q$$

Where,  $E_N = mC^2$  = energy of the particle manifested at the surface of the Black hole due to gravitational interaction. The gravity 'ğ' attained by the Black hole (BH) due to quantum gravity is,  $\check{g} = \check{G}M/2R^2$ .

$\therefore F_Q = \check{g} m$ . But  $2F_Q R = E_Q$  = Energy possessed by the particle due to Quantum Gravity force.

$\therefore E_Q = (\check{G}/2G) E_N = 10^{14} E_N$ , where 'E<sub>N</sub>' is the energy corresponding to gravity at the surface (or event horizon) of the Black Hole due to gravitational force.

Let us consider Newton's universal law of gravitation. According to it,  $F_N = G (Mm/R^2)$ . where  $F_N$  = Force due to gravitation between the two masses 'M' and 'm'.  $G$  = Newton's gravitational constant and the meaning of other symbols being same as in the 1<sup>st</sup> law of Quantum Gravity. Hence this equation is applied to Black Holes only. For Black Holes this equation becomes:

$F_N = mC^2 / 2R$  as  $M/R = C^2/2G$  i.e.  $E_N = mC^2 = 2F_N R$ . But for Black Holes, as will be seen later,  $2mR = k$ , the Quantum Gravity constant.

$$\therefore E_N = mC^2 = 2F_N R = kC^2/2R. = E_N \quad (4) \text{ since}$$

$$kC^2/2 = 9*10^{15}, \quad E_N = (9*10^{15}/R) \text{ ev.}$$

Comparing this equation with the equation,  $E_Q = 10^{14} E_N = 2F_Q R$ , we get  $(F_Q/F_N) = (E_Q/E_N) = (\check{G}/2G) = 10^{14}$ . Thus it is clear that the force of Quantum Gravity, i.e.  $F_Q$ , is  $10^{14}$  times stronger than the gravitational force  $F_N$ . Similarly the quantum of energy  $E_Q$  possessed by a particle due to Quantum Gravity force is also  $10^{14}$  times higher than the corresponding quantum of energy  $E_N$  possessed due to the gravitational force. That is why Gravitational force would be at the mercy of the Quantum Gravity force in Black Hole.

If the equation (3) is multiplied and divided by  $2R$ , we get:

$$F_Q = (\check{G}C^2/2G) * (2mR/4R^2). \text{ But } 2mR = k$$



$$\therefore F_Q = (\check{G} C^2 k / 8G) (1/R^2) \quad (5)$$

That is, the force of Quantum Gravity decreases as the radius 'R' of the Black Hole increases by its square and  $F_Q$  becomes stronger as Black Hole gets smaller and smaller and hence less and less massive but more and more powerful. Hence Black Hole with the smallest radius would be the most powerful object in the universe.

Now if we multiply and divide the equation (1) by  $2R$ , we get;  $F_Q = \{\check{G} (Mm) 2R\} / \{4R^3\}$ . But  $2mR=k$ .  $\therefore F_Q = \check{G}k (M/4R^3)$ . Again multiplying and dividing by  $\pi/3$ , we get,

$$F_Q = \pi/3 (\check{G}k) * (M/4\pi R^3/3).$$

Here the factor  $(M/4 \pi.R^3 / 3)$  represents the density ' $\rho$ ' of the Black Hole. i.e.  $(M/4 \pi .R^3 / 3) = \rho$

$\therefore F_Q = (\pi/3) \check{G} k \rho$  i.e.  $F_Q$  is proportional to the density ' $\rho$ ' of the Black Hole. So as the density of the Black Hole increases its  $F_Q$  increases proportionately. Consequently Black Hole with minimum radius is the densest object in the universe. If we compare the equation (4) with (1) we find that;  $Mm = kC^2/4G = 10^{11} \text{ gm}^2$ .

We know that the energy  $E_Q$  due to QG force is related to  $F_Q$  by the relation  $E_Q = 2F_Q R$ .

$$\therefore E_Q = (\check{G}kC^2/4GR) \quad (6)$$

i.e.  $E_Q = 10^{30}/R \text{ ev}$ . The energy  $E_Q$  is expressed in ev.

*2.3.2. Implications of the 2<sup>nd</sup> law of Quantum Gravity.  $E = ka = kg$ :* According to this law, the surface gravity of gravitating bodies is quantized and hence represents "a field of quantized energy" for micro particles such as atoms, molecules, etc. present on the surface of gravitating bodies like planets etc. This energy is represented by the motion of particles in the form of kinetic energy (KE). Since the surface gravity remains uniform for such bodies like planets, stars, etc. The Kinetic Energy also remains uniform. This uniform field of Kinetic Energy is characteristic of the uniform "Surface Temperature" of such bodies. Thus "the surface gravity

*is intrinsically related to the surface Temperature*". At this temperature the bodies behave like Blackbodies. i.e.  $kg = KT$ . The average Kinetic Energy possessed by particles would be  $3/2 kg = 3/2 KT = KE$ , according to Boltzmann's distribution law. Now, if we apply the equation  $E = kg$  to Earth whose gravity 'g' at the surface is  $g = 981 \text{ cm/sec}^2$ ;  $E = 2 \cdot 10^{-5} \cdot 981 = 1.96 \cdot 10^{-2} \text{ ev}$ . as  $k = 2 \cdot 10^{-5} \text{ ev. /cm/sec}^2$ . Thus the quantum of energy 'E' due to quantization of the surface gravity of the Earth is about  $2 \cdot 10^{-2} \text{ ev}$ . (i.e. about 0.02 ev.) and the average Kinetic Energy is about  $3 \cdot 10^{-2} \text{ ev}$ . This is the energy possessed by the air molecules at its surface in the form of Kinetic Energy. The surface temperature (T) corresponding to this energy is  $E = KT$ , where 'K' is the Boltzmann's constant and the value of 'K' =  $1.38 \cdot 10^{-16} \text{ erg/}^\circ\text{K} = 8.62 \cdot 10^{-5} \text{ ev/}^\circ\text{K}$ . Therefore,  $T = E/K = (1.96 \cdot 10^{-2}) / (8.62 \cdot 10^{-5}) = 223^\circ\text{K}$  (degree Kelvin). Thus, the surface temperature of Earth is about  $223^\circ\text{K}$  ( $-50^\circ\text{C}$ ), which is too low compared to its real surface temperature that is about  $300^\circ\text{K}$ . This temperature is obviously because of the presence of Sun. But at the temperature of  $223^\circ\text{K}$ , the Earth behaves like a blackbody. Similarly for Sun, the energy, E, due to surface Temperature is  $KT = kg$ , where 'g' is the surface gravity of Sun and 'g' =  $2.7 \cdot 10^4 \text{ cm/sec}^2$ . Therefore  $T = kg/K = (1.97 \cdot 10^{-5} / 8.625 \cdot 10^{-5}) (2.7 \cdot 10^4) = 6200^\circ\text{K}$ . [ $k/K = 0.228$  or  $K/k = 4.386$ ]. Thus the surface temperature of Sun is  $6200^\circ\text{K}$  (i.e.  $\approx 6000^\circ\text{C}$ ), which explains why the surface temperature of the sun is what it is now. At this temperature the sun behaves like a blackbody. Now the energy at the surface of the sun due to the quantization of its surface gravity is  $E = kg = (2 \cdot 10^{-5}) \cdot (2.7 \cdot 10^4) = 0.54 \text{ ev}$ . Since the surface temperature of the sun ( $6200^\circ\text{K}$ ) is too low compared to its temperature at corona, the energy 0.54ev possessed by particles due to quantization of its surface gravity is correspondingly too low to account for.

From the above considerations, it is clear that surface temperature and surface gravity are related by the equation  $kg = KT$  i.e.  $g = 4.38 T$  or  $T = 0.22g$ . The Kinetic Energy possessed by

the particles corresponding to the quantization of the gravity or acceleration is given by the relation;

$KE = 1/2mv^2 = kg = ka$ , in non-relativistic case and  $KE = P^2/2m = kg = ka$  in relativistic case.

From this relation it is clear that in the same field of uniform gravity (or uniform acceleration) micro particles of different masses will have different velocities although possess the same energy.

Since the energy corresponding to gravity (or acceleration) is quantized, the relation  $E = kg$  (or  $E = ka$ ) may be readily identified with the Planck's relation  $E = \hbar\nu$  (where  $\hbar = h/2\pi$ ). Therefore,  $kg = ka = \hbar\nu$ . i.e.  $\hbar/k = a/\nu = \check{C}$ . Where,  $\check{C}$  is another fundamental constant like 'C' the velocity of light and  $\check{C}$  also represents velocity. The most important thing is that the value of  $\check{C}$  is reciprocal to the value of 'C'. i.e.,  $\check{C} = 1/C$ . i.e.  $C\check{C} = 1 \text{ cm}^2/\text{sec}^2$  and  $\check{C}/C \approx 10^{-21}$ , a dimensionless number. The value of  $\check{C} = \hbar/k = 1.05 \cdot 10^{-27} / 3.15 \cdot 10^{-17} = 3.33 \cdot 10^{-11} \text{ cm/sec}$  (in cgs units).  $\therefore \hbar = k\check{C}$ . Hence, 'h' and 'k' are intimately related.

As,  $a = \check{C}\nu$ , the *change* in acceleration 'a' is intimately related to the frequency of the radiation 'ν' emitted corresponding to that. Since  $\nu = C/\lambda$ ,  $g = a = (C\check{C}/\lambda) \text{ cm}^2/\text{Sec}^2$ ; but  $C\check{C} = 1 \text{ cm}^2/\text{sec}^2$ , so 'g' or 'a' is reciprocal to  $\lambda$  the wavelength of the radiation emitted. For earth since  $g \approx 10^3 \text{ cm/sec}^2$ ,  $\lambda = 10^{-3} \text{ cm}$ . For Sun,  $g = 2.7 \cdot 10^4 \text{ cm/sec}^2$ .  $\therefore \lambda = 3.7 \cdot 10^{-5} \text{ cm}$ .

If a particle (of course charged) is to possess 1ev of energy in an electro-magnetic field, then the acceleration 'a' corresponding to that must be according to the equation  $E = ka$ ,  $a = E/k = (1/2 \cdot 10^{-5}) \approx 5 \cdot 10^4 \text{ cm/sec}^2$ .

#### 2.4. Proof of the second law of Quantum Gravity i.e. $E = ka$

The second law of Quantum Gravity can be proved experimentally in the following way. In the electro static field, the energy 'E' possessed by the electron is given by the equation  $E = eU/300$  where  $e$  = charge of the electron =  $4.8 * 10^{-10}$ esu,  $U$  = voltage applied in volts and '300' is the conversion factor. So,  $e/300 = 1.6 * 10^{-12}$  erg = 1ev, therefore  $E = U$  ev. If  $U = 1$  volt,  $E = 1$ ev; if  $U = 10^3$  volts,  $E = 10^3$ ev, now we can equate this equation  $E = U$  ev, with the second law of Quantum Gravity, i.e.  $E = ka$  in the form  $E = 2\pi ka$  (This is because 'k' is related to  $\hbar$ , since  $E$  is related to  $2\pi\hbar$ (i.e.  $h$ ) often, we got to take  $2\pi k$  instead of 'k' in such cases). We get  $2\pi ka = U$  ev i.e.  $U = 1.25 * 10^{-4} a$  as 'k' is taken in terms of ev i.e.,  $k = 2 * 10^{-5}$  ev/cm/sec<sup>2</sup>. But we know that  $a = \lambda_{\min} = C\check{C} = 1$  cm<sup>2</sup>/sec<sup>2</sup>. Substituting in the equation  $U = 1.25 * 10^{-4} a$ , we get

$$U = 1.25 * 10^{-4} C\check{C} / \lambda_{\min} \text{ i.e. } U \lambda_{\min} = 1.25 * 10^{-4} C\check{C} = 1.25 * 10^{-4} \text{ volts.cm.}$$

$$\text{i.e. } U \lambda_{\min} = 1.25 * 10^{-4} \text{ volts.cm.} \quad (7)$$

This is the experimentally established expression for the electron in bremsstrahlung. In the book [1] this equation is given in the form  $\lambda_{\min} = 12390/U$ , where  $\lambda_{\min}$  is expressed in angstrom. Thus the expression (7) not only confirms the validity of the second law of QG but also at the same time confirms the value of 'k' =  $2 * 10^{-5}$  ev/cm/sec<sup>2</sup>, the quantizing constant of gravity or acceleration. Hence, the equation  $a = \lambda_{\min} = C\check{C} = 1$  cm<sup>2</sup>/sec<sup>2</sup> is taken in the form  $a = \lambda_{\min} = C\check{C} = 1$ , as  $\lambda_{\min}$  represents the maximum initial energy 'E' possessed by the electron in bremsstrahlung according to the equation  $E = hc / \lambda_{\min}$ .

### 3. Unification Of Physical Interactions.

#### 3.1. First step towards unification of All Four Physical Interactions.

Unification of all four physical interactions is not simply the merging of the four physical forces at different energy levels but it is also merging of macroscopic (classical) world with the microscopic (quantum) world and thereby establishing *intrinsic* relationship between them. It is also to be remembered that QG force is applicable in classical world to only bodies that have attained their gravitational radius like Black holes, Quasars, etc. As a first step towards unification, the two laws related to forces (i.e. Newton's law of gravitation and the first law of QG) which have been shown to be related to their respective quantized energies along with the second law of QG are expressed in the form of a chart known as Black hole (BH) chart. In it different gravitational radii or ranges are related to quantized gravitational energies as well as to quantized QG energies. The two laws in which the two forces related to their quantized energies are,  $E_Q = 2F_Q R$  and  $E_N = 2F_N R$ . Substituting the values of  $F_Q$  and  $F_N$  in them we get,  $E_Q = \check{G}kC^2 / 4GR$  and  $E_N = kC^2/2R$

**3.1.1. Table 1. Black Hole Chart (BH Chart).**

The units are expressed in CGSE system and the Energy in Electron volt (ev.).

Range or Radius of BH in macro world 'R' in cms.	Corresponding mass (M) of the BH $M=(C^2/2G) R$ gms $=6.75*10^{27}R$	Quantum of energy ( $E_Q$ ) possessed due to QG force; $E_Q = \check{G}kC^2/4GR$ ev $= 10^{30}/R$ ev	Free energy/ self – energy in ev Quantum of energy ( $E_N$ ) possessed due to gravitational force; $E_N= kC^2/2R=10^{16}/R$ ev
$10^5$ cm	$6.75*10^{32}$ gm	$10^{25}$ ev ( $10^{16}$ Gev)	$10^{11}$ ev ( $10^2$ Gev)
$10^6$	$6.75*10^{33}$	$10^{24}$	$10^{10}$
$10^7$	$6.75*10^{34}$	$10^{23}$	$10^9$
$10^8$	$6.75*10^{35}$	$10^{22}$	$10^8$
$10^{10}$ cm	$6.75*10^{37}$ gm	$10^{20}$ ev	$10^6$ ev.
$10^{11}$	$6.75*10^{38}$	$10^{19}$	$10^5$
$10^{13}$	$6.75*10^{40}$	$10^{17}$	$10^3$
$10^{15}$	$6.75*10^{42}$	$10^{15}$	$10^1$
$3.8*10^{17}$ cm	$2.55*10^{45}$ gm	$2.7*10^{12}$ ev	$2.7*10^{-2}$ ev
This is the center of the BH chart. The intensity of the interactions increases as we move upwards in the Black Hole Chart.			
$10^{19}$ cm	$6.75*10^{46}$ gm	$10^{11}$ ev	$10^{-3}$ ev
$10^{21}$	$6.75*10^{48}$	$10^9$	$10^{-5}$

$10^{23}$	$6.75 \cdot 10^{50}$	$10^7$	$10^{-7}$
$10^{25}$	$6.75 \cdot 10^{52}$	$10^5$	$10^{-9}$
$10^{27}$	$6.75 \cdot 10^{54}$	$10^3$	$10^{-11}$
$10^{28}$	$6.75 \cdot 10^{55}$	$10^2$	$10^{-12}$
$10^{29}$	$6.75 \cdot 10^{56}$	$10^1$	$10^{-13}$
$1.5 \cdot 10^{30}$	$10^{58}$	$\approx 1 \text{ ev}$	$10^{-14} \text{ ev}$

It is to be noted that in this Black Hole chart bodies, which have attained their gravitational radius exist from  $10^5$  cm to  $3.8 \cdot 10^{17}$  cms only. Bodies with the gravitational radius below this radius or above this radius do not exist. Range or radius  $3.8 \cdot 10^{17}$  cm represents the center of the Black Hole chart. So  $10^5$  cm is the minimum radius and bodies (BH) with radius less than this are not supposed to exist. Like wise,  $3.8 \cdot 10^{17}$  cm is the maximum radius and bodies (Black Holes) with radius higher than this are not supposed to exist. So the range above  $3.8 \cdot 10^{17}$  cm (i.e.  $R > 3.8 \cdot 10^{17}$  cm) is the gravitational range *in terms* of which we observe the outer universe. The maximum range is  $1.5 \cdot 10^{30}$  cms and the corresponding mass being  $10^{58}$  gms.

The maximum energy being  $10^{25}$  ev ( $10^{16}$  Gev) for QG force and  $10^{11}$  ev ( $10^2$  Gev) for the gravitational force corresponding to gravitational range of  $10^5$  cm.

### 3.2. Major step towards Unification of All Four Physical Interactions.

In the preceding section, unification of all four physical interactions is being attempted in the macro (classical) world. The same thing is done here, in this section, in the micro (quantum) world. In order to do this, we have to express both the laws of Force relating to energy in terms of concepts employed in the micro world and also treat acceleration in the same way. So the Black Hole Chart, which corresponds to macro world, is expressed in terms of the concepts of the micro world and this chart is called “Interaction Table” in the micro world. Thus Interaction Table (IT) consists in the relationship between the energy scale and the interaction range (r) at various interaction ranges in the micro world varying between certain maxima and certain

minima. In IT, energy possessed by different micro particles like electron  $e^-$ , proton  $p^+$ ,  $w^\pm$ , etc. at different interaction ranges is given. In addition to this, the decay times of various micro (elementary) particles produced (like pions, leptons, baryons etc.) at different interaction ranges is given.

### 3.3. Interaction Table.

Interaction Table (IT) essentially deals with the micro (quantum) world. IT may be constructed for any micro particle, although here it is constructed for fundamental particles like  $e^-$ ,  $p^+$ ,  $w^\pm$  only. Before presenting the IT, it is necessary to elucidate the meaning of the concepts employed in it. For this, it is essential to remember that for Black Holes the ratio of  $M/R$  is always a constant and  $M/R = C^2/2G$ . Since 'R' is the gravitational radius of the Black Hole and 'M' its mass, 'R' implies 'M'; i.e. the gravitational radius 'R' contains a definite mass 'M' and as "R" varies 'M' correspondingly varies. So here the mass 'M' acts as the binding mass for the gravitational radius 'R'. This relationship between 'M' and 'R' is again intrinsic and describes the strength of the QG force and Gravitational force and quantum energies corresponding to them. The first concept ' $\beta$ ' introduced in IT corresponds to the ratio of  $M/R$ . In fact ' $\beta$ ' is equal to the ratio of  $B_m/r$ , i.e.  $\beta = B_m / r$  where  $r$  = interaction range in the micro world at which the interaction is taking place,  $B_m$  = Binding mass possessed by the particle (like  $e^-$ ,  $p^+$ ,  $w^\pm$ , etc.) for which the IT is constructed corresponding to the interaction range 'r'. Thus the dimension of ' $\beta$ ' is mass per unit length. The value of ' $\beta$ ' is constant for a particular particle and it depends on the mass of the particle. As the mass of the particle increases, ' $\beta$ ' also correspondingly increases. The value of the ' $\beta$ ' for any particle is found at the interaction range of  $1.1 \cdot 10^{-14}$  cm i.e.  $r = 1.1 \cdot 10^{-14}$  cm. At this range the binding mass ' $B_m$ ' of the particle would be equal to its rest mass,  $m_0$ , i.e.  $B_m = m_0$ . Thus for electron ( $e^-$ ) the value of ' $\beta$ ' is  $\beta = B_m/r = m_0/1.1 \cdot 10^{-14} = 0.9 \cdot 10^{-27}/1.1 \cdot 10^{-14} = 0.82 \cdot 10^{-13}$  gm/cm. For, proton ( $p^+$ ),  $\beta = B_m/r = m_0/1.1 \cdot 10^{-14} = 1.67 \cdot 10^{-24}/1.1 \cdot 10^{-14}$

= $1.52 \times 10^{10}$  gm/cm. Similarly, for  $w^\pm$  particle,  $\beta = B_m/r = m_0/r = 1.5 \times 10^{-22}/1.1 \times 10^{-14} = 1.4 \times 10^{-8}$  gm/cm.

Thus the value of ' $\beta$ ' depends on the rest mass of the particle. If,  $r > 10^{-14}$  cm the  $B_m$  corresponding to that would be higher than the rest mass ' $m_0$ ' of the particle (i.e.  $B_m > m_0$ ).

The other concept that has been introduced in the IT is the concept of time ' $t_0$ ' and  $t_0 = 2\pi\hbar/\beta g C^2 \alpha^2$  where  $\hbar$  = Planck's constant;  $g$  = range of weak interaction constant =  $0.75 \times 10^{-16}$  cm (or ' $g$ ' is the unifying range of electro-weak interaction).

$C$  = Velocity of light and  $\alpha = 1/137$ .  $\therefore t_0 \beta = 2\pi\hbar/g C^2 \alpha^2 = 1.85 \times 10^{-27}$  gm. sec/cm. Since RHS is always a constant, the value of ' $t_0$ ' depends on  $\beta$ , which in turn depends on the mass of the particle to which the value of ' $\beta$ ' corresponds. So far a particular particle ' $t_0$ ' is constant, e.g. for  $e^-$ ,  $t_0 = 2 \times 10^{-14}$  sec. for  $p^+$ ,  $t_0 = 10^{-17}$  sec., for  $w^\pm$ ,  $t_0 = 10^{-19}$  sec. The concept of ' $t_0$ ' is introduced in the IT to account for the decay of elementary particles produced in the IT at various interaction ranges ' $r$ ' by the equation  $t = t_0 B_m/Q_m$ , where ' $t$ ' is the decay time of the elementary particle produced in the IT at any interaction range ' $r$ '. ' $B_m$ ' is the binding mass of the particle like  $e^-$ ,  $p^+$ ,  $w^\pm$ , etc. for which the IT is constructed, at the corresponding interaction range ' $r$ ', and ' $Q_m$ ' is the mass corresponding to the quantum of energy ' $E_Q$ ' possessed due to the QG force (as mentioned in the 3<sup>rd</sup> column of the BH Chart) at the same interaction range ' $r$ '. The equation  $t = t_0 B_m/Q_m$  may be also expressed in equivalent form in terms of energy as  $t = t_0 E_B / E_Q$ , where  $E_B = B_m C^2$  = binding energy and  $E_Q = Q_m C^2$  = quantum of energy possessed due to the QG force. There is also another decay time  $t'$  in the IT which is expressed in the form  $t' = t_0 B_m^2/Q_m^2$  or  $t' = t_0 E_B^2/E_Q^2$ ; where the ratio of  $B_m/Q_m$  is raised to the second (2<sup>nd</sup>) power.

*3.3.1. The Role of the concepts; Interaction Range 'r' and 'β' in IT:* In the IT, interaction range ' $r$ ' plays the same role as the gravitational radius ' $R$ ' in the Black Hole chart. The concept ' $\beta$ ' also plays an equally important role in the IT. In case of BH, the acceleration  $\check{g} = \check{G}M/2R^2 = \check{G}C^2/4GR$  as  $M/R = C^2/2G$ . The same ' $\check{g}$ ' due to the QG force is determined in the IT by the



formula,  $\check{g} = \pi\check{G}\beta/2r$ . Equating the two relations, we find that  $\check{G}C^2/4GR = \pi\check{G}\beta/2r$ , i.e.  $r/R = 2\pi G\beta/C^2$ . This is the sort of relationship that exists between the Black Hole chart and the IT or between the classical (Macro) world and the quantum (micro) world; and that is how the gravitational radius 'R' and the interaction range 'r' are related.

For BH, the acceleration 'g' due to the gravitational force, at the surface is determined by the formula  $g = GM/R^2 = C^2/2R$  as  $M/R = C^2/2G$ . In case of IT, the same acceleration 'g' is determined by the formula,  $g = \pi G\beta/r$ . Comparing these two relations, we find that  $C^2/2R = \pi G\beta/r$  i.e.  $r/R = 2\pi G\beta/C^2$ . So again we get the same sort of relationship between the micro-world and the macro-world.

Now the energies in the IT for QG force ( $E_Q$ ), and the gravitational force ( $E_g$ ) are found out by multiplying the accelerations  $\check{g}$  and  $g$  by 'k', the quantizing constant. Therefore,  $E_Q = k \check{g} = \pi\check{G}k\beta/2r$ . It is found that in the equation relating the micro world and the macro world i.e.  $r/R = 2\pi G\beta/C^2$ , the value of 'β' must correspond to  $w^\pm$  particle i.e.  $\beta = 1.4 \cdot 10^{-8}$  gm/cm. Only then the equation holds good and energies  $E_Q$  and  $E_g$  in macro world correspond to  $E_Q$  and  $E_g$  of the micro world. This becomes obvious once the IT is presented. The decay times 't' and  $t'$  may also be expressed in terms of the interaction range 'r' as shown below.

Since,  $t = t_0 E_B / E_Q$  and  $E_B = B_m C^2$  erg. In terms of electron volt (ev.)  $E_B = B_m C^2 / 1.6 \cdot 10^{-12}$  ev.  $= B_m / 1.8 \cdot 10^{-33}$  ev. But  $B_m = \beta r$ ,  $\therefore E_B = \beta r / 1.8 \cdot 10^{-33}$  ev.  $= \beta r C^2$  erg. (energy expressed in terms of 'erg'). Similarly,  $E_Q = Q_m C^2 / 1.6 \cdot 10^{-12} = Q_m / 1.8 \cdot 10^{-33}$  ev. where  $E_Q = \pi\check{G}k\beta/2r$ .  $\therefore Q_m = E_Q / 1.8 \cdot 10^{-33} = (\pi\check{G}k\beta/2r) / 1.8 \cdot 10^{-33}$  gm. Here 'k' is expressed in terms of electron volt (ev),  $k = 2 \cdot 10^{-5}$  ev./cm/sec<sup>2</sup>. The equation  $Q_m = (\pi\check{G}k\beta/2r) \cdot (1.8 \cdot 10^{-33})$  may be also written as  $Q_m = \pi\check{G}k\beta/2rC^2$ , here 'k' is expressed in terms of gm. cm; i.e.,  $k = 3.15 \cdot 10^{-17}$  gm. cm.  $\therefore E_Q = Q_m C^2 = \pi\check{G}k\beta/2r$ , where  $k = 3.15 \cdot 10^{-17}$  gm. cm.

Now substituting these values for  $E_B$  and  $E_Q$  in the equation,  $t = t_0 E_B/E_Q$ ,  $t = t_0 (\beta r C^2 / \pi \check{G} k \beta) 2r$   
 $= t_0 (2C^2/\pi \check{G} k) r^2$ . Since ' $t_0$ ' is constant for a particular particle and  $t_0 = 2\pi \hbar / \beta g C^2 \alpha^2$ , substituting  
in the equation  $t = t_0 (2C^2/\pi \check{G} k) r^2$ ; we get,  $t = (2\pi \hbar / \beta g C^2 \alpha^2) (2C^2/\pi \check{G} k) r^2$   
 $= (4\pi \hbar / \pi \check{G} k g \alpha^2) r^2 / \beta = 2.4 * 10^3 (r^2 / \beta) = t$ .

Since ' $\beta$ ' depends on the mass of the particle considered in the IT; ' $t$ ' depends on both ' $\beta$ ' and  
' $r$ '. But for a particular particle ' $\beta$ ' is constant.  $\therefore$  ' $t$ ' depends on ' $r$ ', for  $e^-$ ,  $\beta = 0.82 * 10^{-13}$   
gm/cm.  $\therefore t_{e^-} = 2.4 * 10^3 / 0.82 * 10^{-13} r^2$ .  $\therefore t_{e^-} = 3 * 10^{16} r^2$ . Similarly for  $p^+$ ,  $t_{p^+} = 1.66 * 10^{13} r^2$  and for  $w^\pm$ ,  
 $t_{w^\pm} = 1.58 * 10^{11} r^2$ .

The decay time ' $t'$ ' is related to ' $r$ ' as follows;

$t' = t_0 E_B^2/E_Q^2$ . Since  $E_B = \beta r C^2$  erg and  $E_Q = \pi \check{G} k \beta / 2r$  erg.  $\therefore E_B^2 = \beta^2 r^2 C^4$  and  $E_Q^2 = \pi^2 \check{G}^2 k^2 \beta^2 / 4r^2$ . Substituting in  $t' = t_0 (E_B^2/E_Q^2)$ , we get,  $t' = t_0 (\beta^2 r^2 C^4) (4r^2 / \pi^2 \check{G}^2 k^2 \beta^2) = t_0 (4C^4 / \pi^2 \check{G}^2 k^2) r^4 = (2\pi \hbar / \beta g C^2 \alpha^2) (4C^4 / \pi^2 \check{G}^2 k^2) r^4$ .  $\therefore t' = (8\pi \hbar C^2 / \pi^2 g \alpha^2 \check{G}^2 k^2) (r^4 / \beta) = 2.9 * 10^{33} * (r^4 / \beta)$  as  
 $8\pi \hbar C^2 / \pi^2 g \alpha^2 \check{G}^2 k^2 = 2.9 * 10^{33}$  which is always a constant.  $\therefore t' = (2.9 * 10^{33} / \beta) r^4$ .

Since the value of ' $\beta$ ' depends on the mass of the particle; for  $e^-$ ,  $t'_{e^-} = 3.5 * 10^{46} r^4$  sec, for  $p^+$ ,  $t'_{p^+} = 1.9 * 10^{43} r^4$  sec., for  $w^\pm$ ,  $t'_{w^\pm} = 1.9 * 10^{41} r^4$  sec. So, the decay times ' $t$ ' and ' $t'$ ' are given by the relations, for  $e^-$ ,  $p^+$  and  $w^\pm$  particles,  $t_{e^-} = 3 * 10^{16} r^2$  sec.  $t'_{e^-} = 3.5 * 10^{46} r^4$  sec.  $t_{p^+} = 1.66 * 10^{13} r^2$  sec  $t'_{p^+} = 1.9 * 10^{43} r^4$  sec.  $t_{w^\pm} = 1.6 * 10^{11} r^2$  sec.  $t'_{w^\pm} = 1.9 * 10^{41} r^4$  sec. The decay times ' $t$ ' and ' $t'$ ' are used as such in the IT.

Similarly the equations for  $E_Q = \pi \check{G} k \beta / 2r$  and  $E_g = \pi G k \beta / r$  are used in the form  $E_Q = 4.7 * 10^2 \beta / r$  eV. and  $E_g = 4.2 * 10^{-12} \beta / r$  eV. (where  $k = 2 * 10^{-5}$  ev. /cm/sec<sup>2</sup>). So the equations for  $e^-$ ,  $p^+$ ,  $w^\pm$  particle become  $E_{Qe^-} = (3.9 * 10^{-11} / r)$  ev.  $E_{ge^-} = (3.4 * 10^{-25} / r)$  ev.  $E_{Qp^+} = (7.2 * 10^{-8} / r)$  ev.  $E_{gp^+}$

$= (6.8 \cdot 10^{-22}/r)$  ev.  $E_{Q_{w\pm}} = (6.84 \cdot 10^{-6}/r)$  ev.  $E_{g_{w\pm}} = (5.9 \cdot 10^{-20}/r)$  ev. These equations for  $E_Q$  and  $E_g$  are used as such in the IT.

The equation for binding energy,  $E_B$  used in the IT is  $E_B = B_m C^2$ . Since  $B_m = \beta r$ ,  $E_B = \beta r C^2$  erg. In terms of ev,  $E_B = \beta r C^2 / 1.6 \cdot 10^{-12} = \beta r / 1.8 \cdot 10^{-33}$  for  $e^-$ ,  $E_{B_{e^-}} = 0.8 \cdot 10^{-13} / 1.8 \cdot 10^{-33} r = r / 2.2 \cdot 10^{-20} = 4.5 \cdot 10^{19} r$ .  $\therefore E_{B_{e^-}} = 4.5 \cdot 10^{19} r$  ev. Similarly, for  $p^+$ ,  $E_{B_{p^+}} = 8.35 \cdot 10^{22} r$  ev. and for  $w^\pm$ ,  $E_{B_{w^\pm}} = 8 \cdot 10^{24} r$  ev.

Thus, now we are in a position to write down the Interaction Table (IT) for different particles (in fact for any particle but we consider only electron  $e^-$ , proton  $p^+$  and  $w^\pm$  particles). In the IT the energy  $E_g$  due to gravitational force (or gravitational interaction) is also called '*Self energy*' or '*free energy*' as it is the energy possessed by the particle due to the interaction taking place at a particular interaction range by virtue of its (particle's) presence in it (interaction range,  $r$ ) and this energy is available *freely* to it. That is why it is called self-energy or free energy.

3.3.2. Interaction Table:

**Table 2.**

The units are expressed in CGSE system and the energy in electron volt (ev)

Interaction range 'r'cm	Binding mass gm. $B_m = \beta r$	Binding energy ev. $E_B =$ $B_m/1.8*10^{-33}$	Energy $E_Q$ due to QG force in ev. $E_Q = 4.7*10^2\beta/r$	Self energy or gravitational energy $E_g =$ $4.2*10^{-12} \beta/r$	Decay		Times
					$t'$ sec $t' = 2.9*10^{33}r^4/\beta$	t secs. $t = 2.4*10^3r^2/ \beta$	
	1) $B_{mc-} = 0.8*10^{-13} r$ 2) $B_{mp+} = 1.5*10^{-10} r$ 3) $B_{mw\pm} = 1.4*10^{-8} r$	1) $E_{Bc-} = 4.5*10^{19} r$ 2) $E_{Bp+} = 8.3*10^{22} r$ 3) $E_{Bw} = 8*10^{24} r$	1) $E_{Qc-} = 3.9*10^{-11}/r$ ev 2) $E_{Qp+} = 7.2*10^{-8}/rev$ 3) $E_{Qw\pm} = 6.8*10^{-6}/rev$	$E_{gc-} = 3.4*10^{-25}/r$ ev $E_{gp+} = 6.4*10^{-22}/r$ ev $E_{gw\pm} = 6*10^{-20}/r$ ev	1) $t'_{c-} = 3.5*10^{46} r^4$ 2) $t'_{p+} = 2*10^{43} r^4$ 3) $t'_{\pm} = 2*10^{41} r^4$	1) $t_{c-} = 3*10^{16} r^2$ 2) $t_{p+} = 1.6*10^{13} r^2$ 3) $t_{w\pm} = 1.6*10^{11} r^2$	
$10^{-5}$ cm	1) $0.8 * 10^{-18}$ gm 2) $1.5 * 10^{-15}$ gm 3) $1.4 * 10^{-13}$ gm	1) $4.5 * 10^{14}$ ev 2) $8.3 * 10^{17}$ ev. 3) $8 * 10^{19}$ ev.	1) $3.9 * 10^{-6}$ ev. 2) $7.2 * 10^{-3}$ ev. 3) 0.7 ev.	1) $3.4 * 10^{-20}$ ev. 2) $6.4 * 10^{-17}$ ev. 3) $6 * 10^{-15}$ ev.	1) $3.5 * 10^{26}$ sec 2) $1.9 * 10^{23}$ sec 3) $1.9 * 10^{21}$ sec	1) $3 * 10^6$ sec 2) $1.6 * 10^3$ sec 3) $1.6 * 10^1$ sec	
$10^{-7}$ cm	1) $0.8 * 10^{-20}$ gm 2) $1.5 * 10^{-17}$ gm 3) $1.4 * 10^{-15}$ gm	1) $4.5 * 10^{12}$ ev 2) $8.3 * 10^{15}$ ev. 3) $8 * 10^{17}$ ev.	1) $3.9 * 10^{-4}$ ev. 2) 0.72 ev. 3) 68 ev.	1) $3.4 * 10^{-18}$ ev. 2) $6.4 * 10^{-15}$ ev. 3) $6 * 10^{-13}$ ev.	1) $3.5 * 10^{18}$ sec 2) $1.9 * 10^{15}$ sec 3) $1.9 * 10^{13}$ sec	1) $3 * 10^2$ sec 2) $1.6 * 10^{-1}$ sec 3) $1.7 * 10^{-3}$ sec	
$5.3 * 10^{-9}$ cm Atomic range.	1) $4.2 * 10^{-22}$ gm 2) $0.8 * 10^{-18}$ gm 3) $0.75 * 10^{-16}$ gm	1) $2.4 * 10^{11}$ ev 2) $4.4 * 10^{14}$ ev. 3) $4.2 * 10^{16}$ ev.	1) $7.4 * 10^{-3}$ ev. 2) 13.6 ev. 3) $1.3 * 10^3$ ev.	1) $6.5 * 10^{-17}$ ev. 2) $1.34 * 10^{-13}$ ev. 3) $1.2 * 10^{-11}$ ev.	1) $3 * 10^{13}$ sec 2) $1.9 * 10^{10}$ sec 3) $1.9 * 10^8$ sec	1) 1 sec 2) $5 * 10^{-4}$ sec 3) $5.3 * 10^{-6}$ sec	
$10^{-13}$ cm Nuclear range	1) $0.8 * 10^{-26}$ gm 2) $1.5 * 10^{-23}$ gm 3) $1.4 * 10^{-21}$ gm	1) $4.5 * 10^6$ ev 2) $8.3 * 10^9$ ev. 3) $8 * 10^{11}$ ev.	1) $3.9 * 10^2$ ev. 2) $7.2 * 10^5$ ev. 3) $6.8 * 10^7$ ev.	1) $3.4 * 10^{-12}$ ev. 2) $6.4 * 10^{-9}$ ev. 3) $6 * 10^{-7}$ ev.	1) $3.5 * 10^{-6}$ sec 2) $1.9 * 10^{-9}$ sec 3) $1.9 * 10^{-11}$ sec	1) $3 * 10^{-10}$ sec 2) $1.6 * 10^{-13}$ sec 3) $1.7 * 10^{-15}$ sec	
$10^{-14}$ cm	1) $0.8 * 10^{-27}$ gm 2) $1.5 * 10^{-24}$ gm 3) $1.4 * 10^{-22}$ gm	1) $4.5 * 10^5$ ev 2) $8.3 * 10^8$ ev. 3) $8 * 10^{10}$ ev.	1) $3.9 * 10^3$ ev. 2) $7.2 * 10^6$ ev. 3) $6.8 * 10^8$ ev.	1) $3.4 * 10^{-11}$ ev. 2) $6.4 * 10^{-8}$ ev. 3) $6 * 10^{-6}$ ev.	1) $3.5 * 10^{-10}$ sec 2) $1.9 * 10^{-13}$ sec 3) $1.9 * 10^{-15}$ sec	1) $3 * 10^{-12}$ sec 2) $1.6 * 10^{-15}$ sec 3) $1.7 * 10^{-17}$ sec	

**Table 3.**

$10^{-15}$ cm	1) $0.8 * 10^{-28}$ gm 2) $1.5 * 10^{-25}$ gm 3) $1.4 * 10^{-23}$ gm	1) $4.5 * 10^4$ ev 2) $8.3 * 10^7$ ev. 3) $8 * 10^9$ ev.	1) $3.9 * 10^4$ ev. 2) $7.2 * 10^7$ ev. 3) $6.8 * 10^9$ ev.	1) $3.4 * 10^{-10}$ ev. 2) $6.4 * 10^{-7}$ ev. 3) $6 * 10^{-5}$ ev.	1) $3.5 * 10^{-14}$ sec 2) $1.9 * 10^{-17}$ sec 3) $1.9 * 10^{-19}$ sec	1) $3 * 10^{-14}$ sec 2) $1.6 * 10^{-17}$ sec 3) $1.7 * 10^{-19}$ sec
$0.75 * 10^{-16}$ cm Electro-weak range Unification	1) $0.6 * 10^{-29}$ gm 2) $1.2 * 10^{-26}$ gm 3) $1.1 * 10^{-24}$ gm	1) $3.3 * 10^3$ ev 2) $6.3 * 10^6$ ev. 3) $6 * 10^8$ ev.	1) $5.2 * 10^5$ ev. 2) $0.94 * 10^9$ ev. 3) $0.9 * 10^{11}$ ev.	1) $4.4 * 10^{-9}$ ev. 2) $8.4 * 10^{-6}$ ev. 3) $8 * 10^{-4}$ ev.	1) $10^{-18}$ sec 2) $1.9 * 10^{-22}$ sec 3) $5.5 * 10^{-24}$ sec	1) $1.7 * 10^{-16}$ sec 2) $10^{-19}$ sec 3) $10^{-21}$ sec
$2.6 * 10^{-18}$ cm Center of IT	1) $2.1 * 10^{-31}$ gm 2) $3.8 * 10^{-28}$ gm 3) $3.6 * 10^{-26}$ gm	1) $1.2 * 10^2$ ev 2) $2.2 * 10^5$ ev. 3) $2 * 10^7$ ev.	1) $1.5 * 10^7$ ev. 2) $2.8 * 10^{10}$ ev. 3) $2.6 * 10^{12}$ ev.	1) $1.3 * 10^{-7}$ ev. 2) $2.4 * 10^{-4}$ ev. 3) $2.2 * 10^{-2}$ ev.	1) $10^{-24}$ sec 2) $5.5 * 10^{-28}$ sec 3) $7.5 * 10^{-30}$ sec	1) $2 * 10^{-19}$ sec 2) $10^{-22}$ sec 3) $10^{-24}$ sec
$10^{-20}$ cm	1) $0.8 * 10^{-33}$ gm 2) $1.5 * 10^{-30}$ gm 3) $1.4 * 10^{-28}$ gm	1) $4.5 * 10^{-1}$ ev 2) $8.3 * 10^2$ ev. 3) $7.9 * 10^4$ ev.	1) $3.9 * 10^9$ ev. 2) $7.2 * 10^{12}$ ev. 3) $6.8 * 10^{14}$ ev.	1) $3.4 * 10^{-5}$ ev. 2) $6.4 * 10^{-2}$ ev. 3) $5.9$ ev.	1) $3.5 * 10^{-34}$ sec 2) $1.9 * 10^{-37}$ sec 3) $2 * 10^{-39}$ sec	1) $3 * 10^{-24}$ sec 2) $1.6 * 10^{-27}$ sec 3) $1.7 * 10^{-29}$ sec
$10^{-22}$ cm	1) $0.8 * 10^{-35}$ gm 2) $1.5 * 10^{-32}$ gm 3) $1.4 * 10^{-30}$ gm	1) $4.5 * 10^{-3}$ ev 2) $8.3$ ev. 3) $7.9 * 10^2$ ev.	1) $3.9 * 10^{11}$ ev. 2) $7.2 * 10^{14}$ ev. 3) $6.8 * 10^{16}$ ev.	1) $3.4 * 10^{-3}$ ev. 2) $6.4$ ev. 3) $5.9 * 10^2$ ev.	1) $3.5 * 10^{-42}$ sec 2) $1.9 * 10^{-45}$ sec 3) $2 * 10^{-47}$ sec	1) $3 * 10^{-28}$ sec 2) $1.6 * 10^{-31}$ sec 3) $1.7 * 10^{-33}$ sec
$10^{-24}$ cm	1) $0.8 * 10^{-37}$ gm 2) $1.5 * 10^{-34}$ gm 3) $1.4 * 10^{-32}$ gm	1) $4.5 * 10^{-5}$ ev 2) $8.3 * 10^{-2}$ ev. 3) $7.9$ ev.	1) $3.9 * 10^{13}$ ev. 2) $7.2 * 10^{16}$ ev. 3) $6.8 * 10^{18}$ ev.	1) $3.4 * 10^{-1}$ ev. 2) $6.4 * 10^2$ ev. 3) $6 * 10^4$ ev.	1) - 2) - 3) -	1) $3 * 10^{-32}$ sec 2) $1.6 * 10^{-35}$ sec 3) $1.7 * 10^{-37}$ sec

**Table 4.**

$10^{-26}$ cm	1) $0.8 * 10^{-39}$ gm	1) $4.5 * 10^{-7}$ ev	1) $3.9 * 10^{15}$ ev.	1) $3.4 * 10^1$ ev.	1) -	1) $3 * 10^{-36}$ sec
	2) $1.5 * 10^{-36}$ gm	2) $8.3 * 10^{-4}$ ev.	2) $7.2 * 10^{18}$ ev.	2) $6.4 * 10^4$ ev.	2) -	2) $1.6 * 10^{-39}$ sec
	3) $1.4 * 10^{-34}$ gm	3) $7.9 * 10^{-2}$ ev.	3) $6.8 * 10^{20}$ ev.	3) $5.9 * 10^6$ ev.	3) -	3) $1.7 * 10^{-41}$ sec
$10^{-28}$ cm	1) $0.8 * 10^{-41}$ gm	1) $4.5 * 10^{-9}$ ev	1) $3.9 * 10^{17}$ ev.	1) $3.4 * 10^3$ ev.	1) -	1) $3 * 10^{-40}$ sec
	2) $1.5 * 10^{-38}$ gm	2) $8.3 * 10^{-6}$ ev.	2) $7.2 * 10^{20}$ ev.	2) $6.4 * 10^6$ ev.	2) -	2) $1.6 * 10^{-43}$ sec
	3) $1.4 * 10^{-36}$ gm	3) $7.9 * 10^{-4}$ ev.	3) $6.8 * 10^{22}$ ev.	3) $5.9 * 10^8$ ev.	3) -	3) $1.7 * 10^{-45}$ sec
$6.66 * 10^{-31}$ cm	1) $5.4 * 10^{-44}$ gm	1) $3 * 10^{-11}$ ev	1) $6 * 10^{19}$ ev.	1) $5.1 * 10^5$ ev.	1) -	1) $10^{-44}$ sec
	2) $10^{-40}$ gm	2) $5.5 * 10^{-8}$ ev.	2) $1.1 * 10^{23}$ ev.	(0.51 Mev)	2) -	2) $5 * 10^{-48}$ sec
	3) $10^{-38}$ gm	3) $5.2 * 10^{-6}$ ev.	3) $10^{25}$ ev ( $10^{16}$ Gev)	2) $0.94 * 10^9$ ev. (0.94 Gev) 3) $9 * 10^{10}$ ev. (90 Gev)	3) -	3) $5 * 10^{-50}$ sec

It directly follows from the IT that,  $E_B/E_Q = t'/t$  at all interaction ranges, r. Comparison of Black Hole chart with the IT shows that the energies  $E_Q$  and  $E_N$  in Black Hole Chart correspond to (or are equal to) energies  $E_Q$  and  $E_N$  of the  $w_{\pm}$  particles in the IT only. Thus confirming the validity of the equation  $r/R = 2 \pi G\beta/C^2$  if and only if 'β' represents  $w_{\pm}$  particles.

IT is not only a Table which gives simply energy values for different particles at various interaction ranges, but it is also “a chart of elementary particles along with their decay times”. Various elementary particles are produced at different interaction ranges and their decay time depends solely on the interaction range at which they decay. If elementary particles of the same kind e.g.  $\pi^{\pm}$  and  $\pi^0$ , decay at different times, it is because they will have different values of  $E_B$  and  $E_Q$  and hence decay at different interaction ranges, r i.e.  $10^{-13}$  cm for  $\pi^{\pm}$  and  $10^{-15}$  cm for  $\pi^0$ .

IT will not say particles of what mass 'ought' to exist and particles of what mass ought not to exist; nor will it say on its own at what interaction range  $r$ , the particle ought to decay unless  $E_B$  and  $E_Q$  are known or the time ' $t'$  or  $t$ ' of decay of the particle of a particular mass is known. But what it says is that if the interaction range  $r$ , at which a particle (whose mass is known) decays, then its decay time must be so and so, and its decay time *cannot* be other than what the IT predicts. If a particle decays at an interaction range  $r$ , above  $10^{-15}$  cm i.e.  $r > 10^{-15}$  cm, then the decay time of the particle is  $t'$  and not ' $t$ '. So we have to use the equation  $t' = 2.9 \cdot 10^{33} r^4 / \beta$  to determine its decay time. If a particle decays at an interaction range ' $r$ ' below  $10^{-15}$  cm i.e.  $r < 10^{-15}$  cm, then its decay time will be ' $t$ ' and not  $t'$ . So we have to use the equation  $t = 2.4 \cdot 10^3 r^2 / \beta$ . The reason is that at  $r > 10^{-15}$  cm  $t'$  is greater than ' $t$ ' i.e.  $t' > t$  and at  $r < 10^{-15}$  cm ' $t$ ' is greater than  $t'$  i.e.  $t > t'$  and at  $r = 10^{-15}$  cm,  $t' = t$ . The decay time, which is longer, is to be taken.

The value of time ' $t$ ' may also be given in terms of the density ' $\rho_{EB}$ ' of binding energy  $E_B$  i.e.  $t = \check{C} C^2 / g \alpha^2 \check{G} (1 / \rho_{EB}) = 3.5 \cdot 10^{35} / \rho_{EB}$  where  $\rho_{EB}$  is expressed in ev. And  $t' = 3.6 \cdot 10^{65} r^2 / \rho_{EB}$ . Here also  $\rho_{EB}$  is expressed in ev. It also follows from IT that,  $t'/t = (2C^2 / \pi \check{G} k) r^2 = 10^{30} r^2$ .

#### 3.4. Final Step Towards Unification Of All Interactions.

A glance at the IT shows that maximum Quantum Gravity energy ' $E_Q$ ' is possessed at the interaction range  $r$ , of  $6.66 \cdot 10^{-31}$  cm by  $w^\pm$  Particle and this energy is  $10^{25}$  ev (or  $10^{16}$  Gev). This energy is equal to the energy ' $E_Q$ ' possessed in BH chart at the gravitational radius of  $10^5$  cm. Likewise, the maximum gravitational energy ' $E_g$ ' (or self energy or free energy) possessed at the same inter action range ' $r$ ' is 90 Gev by  $w^\pm$  Particle, which is the rest mass of the  $w^\pm$  particle itself. Similarly at this range electron and proton possess self-energies equal to their rest masses. The maximum self-energy of 90 Gev in IT is equal to that of gravitational

energy  $E_g$  at the gravitational radius  $R$  of  $10^5$  cm in the BH Chart. This is verified by the relationship between the micro world and the classical world,  $r/R = 2\pi G\beta/C^2$ , where ' $\beta$ ' corresponds to or represents  $w^\pm$  particle.

From IT, it is clear that the values of energies  $E_Q$  and  $E_g$  depend on the mass of the particles considered. So the corresponding accelerations  $\ddot{a}$  and ' $a$ ' also depend on the mass of the particles as acceleration and energy are synonymous in the micro world. If the mass of the particles considered is higher the corresponding acceleration is also higher. But in the Black Hole chart, this point does not arise, as there are no particles considered in it.

Comparison of IT and BH chart shows that the maximum interaction range ' $r$ ' i.e.  $10^{-5}$  cm in IT is reciprocal of the minimum gravitational radius in the BH chart i.e.  $10^5$  cm. Likewise, the minimum ' $r$ ' of  $6.66 * 10^{-31}$  cm in the IT is reciprocal of the maximum gravitational radius of  $1.5*10^{30}$  cm. So change in the values of extreme interaction ranges in IT will also bring about corresponding change in the values of extreme gravitational radii of the BH chart, thus thereby bringing about corresponding change in energy values of  $E_Q$  and  $E_g$  of both IT and BH Chart.

The center of the IT is at ' $r$ ' of  $2.6 * 10^{-18}$  cm. So this is the square root of the product of maximum and minimum interaction ranges ' $r$ ' in IT. i.e.

$$2.6 * 10^{-18} = (10^{-5} * 6.66 * 10^{-31})^{1/2} \text{ as } 2.6 * 10^{-18} / 10^{-5} = 6.66 * 10^{-31} / 2.6 * 10^{-18}$$

The electro-weak interaction range i.e. the unification of the electro -magnetic force with the weak force comes prior to the center of IT that is it comes at  $0.75 * 10^{-16}$  cm; and the energy ' $E_Q$ ' possessed by  $w^\pm$  particle corresponding to this range is 90 Gev, which is also the rest energy of the  $w^\pm$  particle. Similarly electron  $e^-$  and proton  $p^+$  also possess energies ' $E_Q$ ' equal to their rest energies i.e. 0.51 Mev and 0.94 Gev respectively. At the minimum ' $r$ ' of  $6.66*10^{-31}$  cm also the self energy  $E_g$  possessed by these particles is equal to their rest energies and at this range these particles manifest themselves due to free energy  $E_g$  available to them and in the BH



chart this free energy  $E_N$  is due to the gravitational force. “Thus the gravitational field acts like self energy or free energy field in the micro world”. In the BH chart, at the minimum gravitational radius of  $10^5$  cm, the self-energy possessed by  $e^-$ ,  $p^+$  and  $w^\pm$  particle is equal to their *rest energy*. Thus signifying the unification of electro magnetic force with the weak force (i.e. the Electro-weak force) at the surface of the BH of  $10^5$  cm. But if we go through the BH chart, we notice that even before the biggest Black Hole i.e. a Quasar, is formed corresponding to gravitational radius of  $3.8 \times 10^{17}$  cm, the unification of Electro-Magnetic force with the weak force has taken place at the QG level as the energy  $E_Q$  corresponding to QG force at this radius is  $2.7 \times 10^{12}$  ev. Which is higher than the Electro weak unification threshold of  $10^{11}$ ev (or  $10^2$  Gev). Infact the Electro-weak threshold level is reached at the gravitational radius of  $10^{19}$  cm corresponding to Quantum Gravity energy ( $E_Q$ ) of  $10^{11}$ ev.

The BH chart provides us with only one energy level for both  $E_Q$  and  $E_g$  (or  $E_N$ ) at a particular gravitational radius, where as IT provides us with a number of different energy levels for particles of different masses at the same interaction range ‘r’. Thus IT is richer in energy structures than the BH chart and consequently more complicated than it, although the underlying theme behind both of them is the same.

The most important column in IT is that of energy  $E_Q$  due to QG force, we can see how  $E_Q$  appears in various forms right from the maximum range of  $10^5$  cm down to the minimum range of  $6.66 \times 10^{-31}$  cm. At higher interaction ranges ‘r’ it ( $E_Q$ ) is too weak and appears as molecular energies, atomic energy, spin energy above  $5.3 \times 10^{-9}$  cm and nuclear energy at  $10^{-13}$  cm. Then it appears as quark energy due to strong interaction down to range of around  $10^{-22}$  cm when it possesses maximum energy of about  $10^{17}$  ev ( $10^8$  Gev). Well below this range, at around  $10^{-24}$  cm and below, even the concept of quark may not be sufficient to explain the structure of matter

and matter may have different structures. Strong force combines with the Electro-weak force at around  $10^{-22}$  cm and forms the GUTs force.

It is interesting to note that through out IT and BH Chart, the gravitational force ( $F_g$ ) and its energy ( $E_g$  or  $E_N$ ) never merges with the QG force ( $F_Q$ ) and its energy ( $E_Q$ ) and always keeps same distance from it. The ratio of the strengths always being  $\check{G}/2G \approx 10^{14} = E_Q/E_g = F_Q/F_g$ . Thus  $F_g$  is too weak compared to its counterpart  $F_Q$  and always being subservient to it.

The IT never makes distinction between particles of different nature i.e. whether they are leptons, mesons, baryons, quarks, etc and it treats them on the same footing.

The energies  $E_Q$ ,  $E_g$  and  $E_B$  are given for one single particle having single charge i.e.  $Z=1$ . If there are more than one particle and consequently more than one charge i.e.  $Z > 1$ , then the total energy possessed by the particles at the same interaction range, 'r' must be given by the expression  $E_Q Z^2$ ,  $E_g Z^2$ , etc., where  $E_Q$ ,  $E_g$ , represent energy possessed by one (single) particle for single charge.

#### **4. Black Hole Dynamics Or Quantum Gravity Field.**

While discussing the QG force, it is said that it exists inside BH. The field associated with the QG Force is the QG field. So QG field is limited to objects, which have attained their gravitational radius. Thus the QG field exists inside Black Hole. The immediate question that arises is "What is the nature of this QG field"? In order to answer this question we will have to consider "different types of motion".

The special theory of Relativity deals with uniform motion (i.e. uniform velocity) in which acceleration is absent. While the General Relativity (GR) deals with the motion of test masses in gravitational field in which the velocity is non-uniform but the acceleration is uniform. Thus GR deals with uniform accelerated motion in which the velocity of test masses of classical size

will be varying. But these two types of motion cannot obviously account for the motion of micro particles, which is done by the quantum Mechanics (QM.). At the same time QM cannot describe the motion of test masses of classical size, which is done by the classical physics. So in order to describe the motion of both i.e. of test masses of classical size and micro particles of quantum size on the same basis we have to go to different type of motion which is the foundation for the unification of both classical physics as described by GR and microphysics as described by QM and this type of motion is the varying accelerated motion in which the acceleration is non-uniform or varying along the direction of motion. The frame of reference corresponding to this is the varying accelerated frame (VAF).

The next question is “how acceleration varies”? Because it can vary haphazardly or constantly (i.e. change in acceleration is constant) or it can vary exponentially. But in the final analysis, in order to describe motion in the micro world especially “Bremsstrahlung”, it turns out that “exponentially varying accelerated motion” is the one we have to consider to bring both GR and QM on the same platform and the field corresponding to this is the exponentially varying accelerated field (EVAF). So it is in EVAF that both test masses and micro particles describe the same path and hence obey the same set of equations to describe their motion with respect to which they would be symmetric. It is this EVAF, which is the QG Field. Thus in QG field acceleration (or gravity) will be varying exponentially and *gravitation in its distorted form* and QM are combined; *gravitation in its distorted form*, because gravity (or acceleration) which is uniform in gravitation will be varying exponentially in the QG field.

Another reason why we have to go to varying accelerated motion is that, according to the second law of QG, acceleration and energy are equivalent for a micro particle and transitions in the quantum energy of the particle is possible *if and only if* there is change in its acceleration and not otherwise as uniform acceleration means uniform energy and hence uniform velocity

for micro particles and the acceleration changes exponentially because the energy of a micro particle changes exponentially in the electro magnetic field as it is evident from “Bremsstrahlung” in which the energy of the particle (electron) changes exponentially according to the Relativistic quantum mechanics. The formula being  $E = E_0 \exp (-x/x_0)$  Here the particle (electron) is losing its energy exponentially. ‘ $E_0$ ’ being the initial energy, ‘ $x$ ’ being the distance covered by the particle in the Electro-magnetic (EM) field and ‘ $x_0$ ’ is the radiation length which depends on the nature of the substance in which the particle is moving producing bremsstrahlung in its (substance’s) EM field. ‘ $x_0$ ’ is constant for a particular substance.

Now according to the second law of QG, the equation  $E = E_0 \exp (-x/x_0)$  is equivalent to  $a = a_0 \exp (-x/x_0)$ . This is how acceleration varies exponentially in the EM field. This is how gravity (or acceleration) varies in the QG field (or in EAVF). But there is a contrasting difference in the way acceleration varies in these two fields. To understand this we have to go to Newton’s 2<sup>nd</sup> law of motion i.e.  $F = m a$ . If ‘ $F$ ’ here means EM force acting between the two terminals and ‘ $m$ ’ is the mass of the particle moving in it, then ‘ $a$ ’ is the acceleration possessed by the particle at the end point of its motion between the two terminals. Now if the mass ‘ $m$ ’ of the particle increases, i.e. particles of heavier masses travel in the same force field, then the acceleration possessed by them would decrease correspondingly. That is if the mass increases by 100 times, the acceleration possessed would decrease by 100 times; so that the EM force ‘ $F$ ’ remains same or invariant. If the mass decreases by 100 times, the acceleration would increase by 100 times and ‘ $F$ ’ again remains invariant. So the EM force is a static (or passive) force.

Let us consider the gravitational force. In the equation  $F = m a$  if ‘ $F$ ’ is the gravitational force and ‘ $m$ ’ is the mass of the particle moving in it, ‘ $a$ ’ would be the acceleration possessed by it. If the mass of the particle considered is increased, the force ‘ $F$ ’ correspondingly increases keeping the acceleration same or uniform. Suppose the mass of the particle considered is increased by

100 times, the corresponding gravitational force would also increase by 100 times, thus keeping the acceleration uniform and if the mass is decreased by 100 times the gravitational force would correspondingly decrease by 100 times, again keeping the acceleration uniform. Thus gravitational force is an active (or dynamic) force.

Now we will consider the same equation  $F = ma$  for the QG force. Here 'F' represents the QG force, 'm' is the mass of particle and 'a' is the acceleration possessed by it in the QG field. If the mass of the particle considered in the QG field is increased by 100 times, the acceleration 'a' also increases by 100 times, thus increasing the QG force 'F' by  $100^2$  times. If the mass 'm' of the particle is decreased by 100 times, the acceleration 'a' would also correspondingly decrease by 100 times, thus decreasing the QG force 'F' by  $100^2$  times. So the QG force is a *diabolically* active force.

From the above considerations of the three forces (EM force, gravitational force and the QG force), if the mass 'm' of the particle increases by 'n' times the force 'F' in the equation  $F = m a$  increases by the factor  $F * n^0$  (for the EM force),  $F * n^1$  (for the gravitational force) and  $F * n^2$  (for the QG force). That is how acceleration is being affected by the nature of the force acting.

Let us go back to the equation,  $a = a_0 \exp (-x/x_0)$ , in which the initial acceleration 'a<sub>0</sub>' is decreasing exponentially; so 'a<sub>0</sub>' must be always greater than 'a' i.e.  $a_0 > a$ . If the acceleration is increasing exponentially then the above equation is written as  $a = a_0 \exp (x/x_0)$ , where again 'a<sub>0</sub>' is the initial acceleration, but 'a<sub>0</sub>' is always smaller than 'a'; i.e.  $a_0 < a$  and 'a' is the final acceleration attained. According to the equations  $a = a_0 \exp (x/x_0)$ , and  $a = a_0 \exp (-x/x_0)$ , acceleration is increasing exponentially in the former equation and it is decreasing exponentially in the latter equation. We can set the two equations in such a way that the way acceleration increases exponentially in the former equation, decreases exponentially exactly in the opposite

direction in the latter equation. So that a particle gaining acceleration in an EM field is losing it in exactly the same way but in opposite direction. This is tantamount to saying that a particle (say electron) gaining energy in the EM field and losing it (as in bremsstrahlung) are exactly equal but opposite process, if pre requisite conditions are met.

In the EVAF, along with the acceleration the force also will be varying exponentially. This becomes obvious if we consider the equations  $F = ma$  and  $a = a_0 \exp(x/x_0)$ , Combining both,  $F = ma_0 \exp(x/x_0)$ . But  $F_0 = ma_0 =$  initial force; therefore,  $F = F_0 \exp(x/x_0)$  ('F' is increasing). Hence in EVAF, starting with some initial force  $F_0$ , the force will vary exponentially until it attains the final value of 'F'.

In accordance with the second law of QG, the EM force is brought under the scope of EVAF and the change in the energy states of the particle is because of change in its acceleration states.

Since QG field is an EVAF, in which both the gravitational field and the EM field vary exponentially, both gravitational field and the EM Field are intertwined in it and together form the QG field. The equations describing how gravitational field and the EM field are combined in the QG field are similar to the equations describing how electric field and magnetic field are combined to produce EM field in the Maxwell's equations, although there are some fundamental differences between both.

The equations describing the QG field are:

$$\text{div } \mathcal{G} = 4\pi \rho_m \quad (8)$$

$$\text{curl EM.} = [(1/\check{C}) * (d\mathcal{G}/dt)] + 4\pi\sigma/\check{C} \quad (9)$$

$$\text{div EM} = 4\pi\rho_e \quad (10)$$

$$\text{curl } \dot{G} = [(1/\dot{C})(dEM/dt)] + 4\pi j/\dot{C} \quad (11)$$

$\dot{G}$  = Gravitational Field strength

$\rho_m$  = Mass density

EM = Electro Magnetic Field Strength

$\sigma$  = density vector of mass jet.

$\rho_e$  = Charge density

$j$  = Density vector of Electric current.

$\dot{C}$  is the velocity encountered in the QG field. It is the minimum change in the velocity or minimum velocity attainable by particles:  $\dot{C} = \hbar/k = \text{velocity of the QG field} = 3.333 \cdot 10^{-11}$  cm/sec. In other words, velocity smaller than  $\dot{C}$  is impossible. If 'C' is upper limit, ' $\dot{C}$ ' is the lower limit.

The first equation is an inverse square law and also says, "How the gravitational field is related to the distribution of mass". The third equation is also an inverse square law and says, "How EM field is related to the distribution of electric charges". The second equation says "how the rate of change of the gravitational field" at any moment is determined by what are the values of the EM field and the mass-jet are, at that moment. Similarly the 4<sup>th</sup> equation says "how the rate of change of EM field" at any moment is determined by what are the values of the gravitational field and the electric current are at that moment.

The EM field moves with the velocity "C" where as QG field propagates with the velocity ' $\dot{C}$ '. In Quantum Gravity field, particles already move with velocity fast approaching 'C'. Under

such circumstances it is much wiser to ask the question “what is the minimum change in velocity which the particles undergo?” The answer is clearly  $\check{C}$ .

The quantum of energy of the EM field is the photon. While discussing the IT it is said that the quantum of energy ‘ $E_Q$ ’ of the QG field assumes various forms i.e. at higher interaction ranges ‘ $r$ ’, it ( $E_Q$ ) becomes photon (or quantum of EM field); at lower values of ‘ $r$ ’ it becomes the quantum of strong interaction (Gluon), the quantum of the unified Electro-weak-force, the quantum of grand unified theory, etc. as the ‘ $r$ ’ decreases and ‘ $E_Q$ ’ becomes more and more powerful. In such cases, in the above equations EM field symbolized as EM will have to be replaced by corresponding forces and their symbols instead of EM; So  $dEM/dt$  in the above equations becomes  $dS/dt$  for strong interaction, where ‘ $S$ ’ symbolizes the strong interaction. For Electro-weak interaction (EW) the symbol becomes  $dEW/dt$ , etc. But the gravitational interaction and its symbol  $dG/dt$  remain unchanged in all cases as it is the varying gravitational force (GF) which is compared to all other types of forces such as EM, Weak, Strong etc. at different interaction ranges.

It is the second law of QG, which plays the central role in combining varying gravitational force (GF) with other types of forces such as EM, EW, and GUTs etc. Because it is the varying acceleration (or gravity) which represents the strength of the GF (or G force) on the one hand and also strength of the quanta of energies of EM, weak, strong, GUTs etc. fields (or forces) on the other hand. Thus it is the second law of QG, which has made it possible to unify GF with the other types of forces.

Now as to the question “what is the quantum of the GF”? The answer is “*There is no quantum of the GF*” as such, like the quanta of EM field, strong force, etc. In other words, “*there are no*



*gravitons*”, but the quanta of GF could be photons, Gluons, etc. corresponding to the strength of the GF which is related to the radius of the Black Hole or to the interaction range ‘r’. This becomes obvious if we go through the energy ‘E<sub>Q</sub>’ column of Black Hole chart or IT. This conclusion also follows from the second law of QG. According to which gravity (acceleration) is quantized and represents quantum of energy and this energy could be in the form of kinetic or potential energy of particles and liberated in the form of photon, Gluon, etc., depending on the strength of the quantum emitted.

In the EVAF (Represented by QG field or EM field) the concept of “rate of change of acceleration or gravity with distance (dx)”(i.e.  $da/dx$  or  $dg/dx$ ) plays an important role, because it is this, which measures the strength of the EVAF. If the acceleration is decreasing then,  $-(da/dx) = a/x_0$  where ‘x<sub>0</sub>’ depends on the density of the QG field (i.e. density of the Black Hole) or density of the substance in case of EM field as in bremsstrahlung and remains invariant during “rate of change of acceleration i.e.  $da/dx$ ”. The integration of  $da/dx$  gives  $a = a_0 \exp(-x/x_0)$  where ‘a<sub>0</sub>’ is the initial acceleration and since the acceleration is decreasing ‘a<sub>0</sub>’ will be higher than ‘a’. If the acceleration is increasing, then the equation,  $a = a_0 \exp(-x/x_0)$  is written as  $a = a_0 \exp(x/x_0)$  where ‘a<sub>0</sub>’ is again the initial acceleration and ‘a’ is the final acceleration attained, so ‘a’ will be always higher than ‘a<sub>0</sub>’

The rate of change of energy is called “radiant power”. Since acceleration is closely related to energy and being a form of it (energy) “the rate of change of acceleration,  $da/dx$ ” may be called ‘*radiance*’. This may be all right in the micro world but in the classical world this may have to be called by another name. ‘*Radiance*’ cannot remain uniform in EVAF unlike acceleration, which remains uniform in the gravitational field, or velocity that also remains uniform in the uniform velocity frame of Special Theory of Relativity.

## 5. The Nature of the QG Field.

The QG field acts from the surface (or event horizon) of Black Hole towards its center. Thus a Black Hole is not a static, solid object but a region of diabolically active events, in which the jet of mass entering from its surface moves towards the center with increasing acceleration starting from a definite initial acceleration ‘ $a_0$ ’ from the surface, the acceleration of the jet of mass increases exponentially until it reaches a maximum value of  $10^{14}a_0$  at the center of the Black Hole. Thus the ratio of the final acceleration ‘ $a$ ’ to ‘ $a_0$ ’ being always  $a/a_0 = \check{G}/2G = 10^{14}$  which is always equal to the ratio of two constants ‘ $\check{G}$ ’ of QG and ‘ $G$ ’ of gravitation. Thus the energy of the particles constituting the jet of mass also increases by the factor  $10^{14} = E/E_0 = \check{G}/2G$ .

Now an important question arises, “is there a path which the jet of mass (which consists of streams of particles) follow in the QG field, while moving towards the center of Black Hole”? Or in other words, “What is the Path, if it is there, described by macroscopic test masses (or test bodies) and micro particles in the EVAF”?

The answer is, “*There is a definite path*” described in QG field or in EVAF. The path described in the QG field is “*Spiral*”. What kind of ‘spiral’? because there are many types of spiral. It is “*Logarithmic Spiral*” (or “*Equiangular spiral*”). So the jet of mass while moving towards the center of Block Hole, follows the “*Logarithmic–Spiral Path*” in the QG field.

*If an inertial frame is performing EVA motion, it describes a logarithmic spiral (LS) path and micro particles present in it describe a “conical spiral” and projection of this conical spiral (CS) gives LS. So whether micro particles describe a LS or CS, it is the same. So is the case with macroscopic test masses (or test bodies) in EVAF. That is why it is only in EVAF that both test masses and micro particles describe the same path and their motion is symmetric.*

Courtesy: web images.

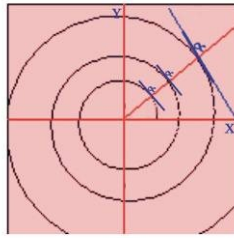

**Figure1.** Logarithmic spiral

Any field, which imitates EVAF, must be a spinning one; and the direction of spin (inward or outward i.e. clockwise or anti-clockwise) describes a LS path, and also determines the direction of motion. A jet of mass entering a Black Hole moves inwards towards its center.

Thus in this case *the Block Hole is an inward spinning sphere of mass. Hence QG field is a spinning field.* So it is possible for us to describe QG field ‘geometrically’ like the gravitational field, although there is a basic difference between both geometries, which describe them. QG field is a ‘Torsion’ field and to describe LS path, the concept of Torsion is made use of, as it is a must. *So geometrical interpretation of LS is the geometrization of the QG field.* Like EVAF, LS, also describes the *exponential* variation of quantities like acceleration, energy, force, etc., in the form of exponential variation of the radius vector and the related quantities. Before presenting the geometry of LS let us go through some of its remarkable properties.

5.1. *Logarithmic Spiral (LS)*

Courtesy: web images.

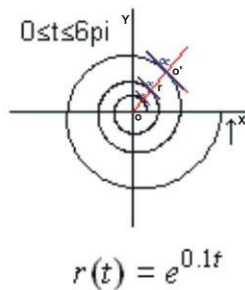

**Figure 2** LS with  $\cot \alpha = b = 0.1$  and  $\theta$  (or  $t$ )  $= 6\pi$ .

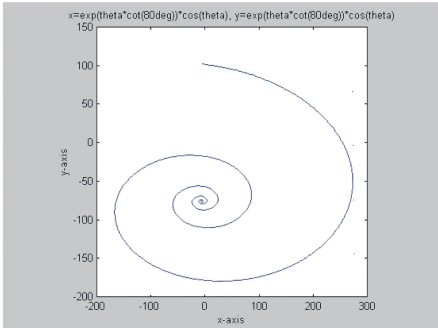

LS is also called equiangular spiral, Bernoulli spiral, Growth spiral and Fibonacci spiral (due to its relation to Fibonacci numbers). On the surface of a sphere, LS's analogue is a *loxodrome*.

It is equivalent to conical spiral (CS).

Courtesy: web images.

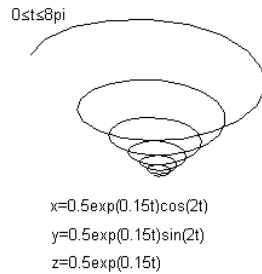
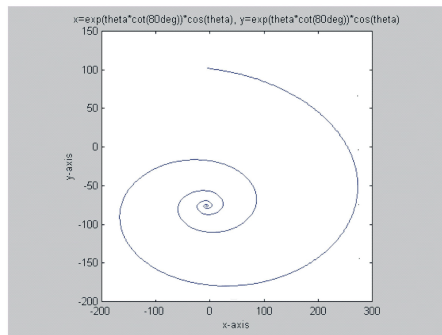

**Figure 3.** CS:  $c = 0.5$ ;  $b = 0.15$ ;  $\theta = t = 8\pi$

The remarkable qualities of the spiral are; the curve is identical to its own 1) Caustic, 2) Evolute, 3) Inverse, 4) In volute, 5) Orthoptic, 6) Pedal and 7) Radial.

5.1.1. *Mathematical and Geometrical Description of LS:*

Courtesy: web images.



**Figure 4.**  $c=1$ ;  $b=0.176$

The polar equation of LS is given by  $R = c \exp(b\theta)$ , where 'R' is the radius i.e. the distance from the origin and 'θ' is the angle from the x-axis; 'c' is a scalar and  $b = \cot \alpha =$  growth rate of the LS which is a constant for a particular LS and 'α' is the constant angle of the LS with which it coils or uncoils; and 'α' is the constant angle between the radius of vector and the tangent at any point on the LS. That is why LS is also called *equiangular spiral*. According to the equation  $R = c \exp(b\theta)$ , radius 'R' grows exponentially with the angle 'θ'. The distances of the

curves of the LS are in geometric progression from the origin as represented by the scalar 'c' in the above equation. The parametric equations are;  $x = R \cos \theta = c \cos \theta \exp(b\theta)$  and  $y = R \sin \theta = c \sin \theta \exp(b\theta)$ . The rate of change of radius 'R' is  $dR/d\theta = c b \exp(b\theta) = b R$

The arc length 's' in polar coordinates is  $ds^2 = dR^2 + R^2 d\theta^2$ . The arc length 's' as measured from the origin is  $s = \{c (1+b^2)^{1/2}/b\} \exp(b\theta) = R (1+b^2)^{1/2}/b = R \{1+(1/b^2)\}^{1/2} = s$ .

For LS, the Torsion 'T' and curvature 'K' are related by the equation;

$$T/K = b = \cot \alpha = \text{constant for a particular LS}$$

The relation between 'K' and 's' (the arc – length) is  $s = 1/Kb$ .

Therefore 'T' is related to 's' by the relation  $T = 1/s$  i.e. Torsion of LS is nothing but reciprocal of its arc-length.

If 'ρ' is the radius of curvature, then  $\rho = 1/K$  and if 'σ' is the radius of Torsion 'T', then  $\sigma = 1/T$ . Therefore, it follows that  $\sigma = s$  i.e. the radius of Torsion and the arc-length in LS are one and the same. Similarly 's' and 'ρ' are related by the equation  $\rho = b s$  i.e. the radius of curvature is proportional to the arc-length of LS. Like wise,  $\rho/\sigma = T/K = b = \cot \alpha$ .

The multiplication of the LS is equivalent with a "rotation". So it is clear that LS and conical spiral paths imply Torsion forces and since QG field and EVAF are spinning fields which follow above paths, it follows that both QG field and EVAF are Torsion fields and hence geometries implying Torsion forces which describe LS and conical spiral (CS) path must be used to describe both fields. If Tensors are used to describe the geometry then Tensor geometry implying Torsion must be used. Since there are so many kinds of spirals, which also imply 'Torsion', we must choose Tensor geometry of Torsion, which describes the LS and CS there by describing QG field, and EVAF. In order to do this, it is necessary to describe physical

quantities such as acceleration, energy, velocity, etc. in terms of geometrical concepts like curvature, arc-length, radius vector, angle, etc.

## 6 Geometry of QG Field (Geometry of LS)

Courtesy: web images.

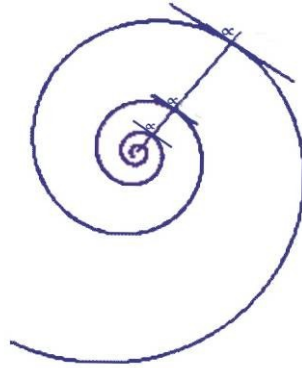

**Figure 5.**  $\theta = 8\pi$

Courtesy: web images.  
Equiangular Spiral

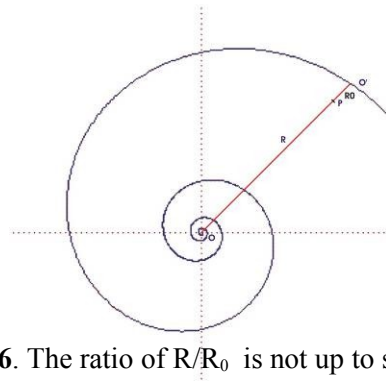

**Figure 6.** The ratio of  $R/R_0$  is not up to scale

We know that in the QG field, the acceleration varies exponentially. The increase in the acceleration is given by the relation

$$a = a_0 \exp(R/R_0) \tag{12}$$

Where,  $a_0$  is the initial acceleration at the surface of the BH.

$a$  = final acceleration attained at the center of the BH.

$R$  = radius of the BH from its center to its surface =  $OO'$

$R_0$  = minimum constant radius in terms of which the radius  $R$  is increasing along the radius vector line =  $O'P$

The meaning of  $R_0$  can be made clear if we go to exponential variation of acceleration (decrease in it) in bremsstrahlung by electron according to the relation  $a = a_0 \exp(-x/x_0)$ . Where  $x_0$  is the constant length of radiation, which depends on the density of the substance through whose electro-magnetic field the electron is passing undergoing deceleration. Similarly  $R_0$  also depends on the density of the BH. The value of  $R_0$  would be smaller if the density of the BH is

higher and vice-versa. The value of  $R_0$  can be easily calculated if the radius  $R$  of the BH is known as follows. The ratio of  $(a/a_0)$  for any BH is always a constant and  $(a/a_0)=(\ddot{G}/2G)=10^{14}$  i.e.  $(a/a_0)=10^{14}=\exp(32.5)$ . But,  $(a/a_0)=\exp(R/R_0)$ .  $\therefore \exp(32.5)=\exp(R/R_0)$ , i.e.  $(R/R_0)=32.5$   
 $\therefore R_0=R/32.5$ .

If we apply the concepts of  $R$  and  $R_0$  to LS, it is evident that in parametric forms  $R=c \exp (b\theta_R)$  and  $R_0=c \exp (b\theta_0)$ . Where 'c' is a scalar and an arbitrary constant, 'b' is rate of growth of the LS (or coiling or uncoiling of the LS).  $\theta_R$  corresponds to 'R' and is the total angle subtended by the rotation along the LS path by the particle (or by mass-jet) from the event-horizon of the BH to its center. Hence  $\theta_R$  corresponds to the total number of rotations  $n_R$  made i.e.  $\theta_R=2\pi n_R$ .

Similarly  $\theta_0$  is the angle subtended by the particle corresponding to the minimum constant radius vector  $R_0$  and hence  $\theta_0=2\pi n_0$ . Where  $n_0$  corresponds to  $\theta_0$ .

$$\therefore (R/R_0)=\exp (b\theta_R)/\exp (b\theta_0)=\exp (b(\theta_R-\theta_0))=\exp (2\pi b(n_R-n_0))=\exp (2\pi bn). \quad (13)$$

Where  $n=n_R-n_0$ =number of rotations made between  $n_R$  and  $n_0$ .

Now substituting this value of  $R/R_0$  in the equation (12) we get,

$$(a/a_0)=\exp (\exp (2\pi bn)) \quad (14)$$

This is how exponential variation in acceleration is related to the rotation (or spin) of the QG field along LS path in BH.

### 6.1. Application of Spinors to QG field and the derivation of the Immirzi- Parameter:

Now let us apply the concept of 'spinors' to the equation (14) i.e. to the QG field (or LS path).

We got to apply it in *two* steps. Let us first apply spinors to the equation (13) i.e.  $R/R_0 = \exp (2\pi bn)$ . Here the rotation angle 'θ' represented in the form  $2\pi bn$  (i.e. the power of the exponent) acts as isotropic vector and  $R$  and  $R_0$  represent its spinor components. So if  $R$  and  $R_0$

make one rotation, then  $2\pi bn$  makes ‘twice’ this rotation. So the exponential factor becomes  $4\pi bn$  and consequently the equation  $R/R_0 = \exp(2\pi bn)$  becomes  $R/R_0 = \exp(4\pi bn)$ .

Now in the second step, we apply it to the equation (12) i.e.  $a/a_0 = \exp(R/R_0)$ . Here  $R$  and  $R_0$  now behave as ‘isotropic vectors’ and ‘ $a$ ’ and ‘ $a_0$ ’ as their spinor components. So for every single rotation of  $a/a_0$ , the exponential factor  $R/R_0$  becomes  $2R/R_0$  and consequently the equation (12) becomes,  $a/a_0 = \exp(2R/R_0)$ .

Substituting these values in the combined equation (14) we get,

$$a/a_0 = \exp(2\exp(4\pi bn)) \quad (15)$$

This equation establishes the relationship between variations in the acceleration of particles to their rotation along LS path in QG field. For any BH, the ratio of  $a/a_0$  is always a constant and  $a/a_0 = \tilde{G}/2G = 10^{14}$ . Substituting this value in the equation (15) we get  $\exp(2 \exp(4\pi bn)) = 10^{14}$ .

But,  $10^{14} = \exp(32.5)$ . Therefore,  $\exp(2 \exp(4\pi bn)) = \exp(32.5)$ . i.e.  $2\exp(4\pi bn) = 32.5$

i.e.  $\exp(4\pi bn) = 16.25$ . But,  $16.25 = \exp(2.8)$ , therefore,  $\exp(4\pi bn) = \exp(2.8)$ . i.e.  $4\pi bn = 2.8$ .

Therefore,  $bn = 0.7/\pi$ . i.e.  $bn = 0.7/3.142 = 0.223$ .

$$\text{i.e.} \quad bn = 0.223 \quad (16)$$

The constant RHS value i.e. 0.223 corresponds to the value of *Immirzi-Parameter* (IP) for BH.

Thus the product of ‘ $bn$ ’ is equal to IP and is the same for all BH irrespective of their radii.

### 6.2. Application of Tensors to the QG field (or LS path):

Since QG field is a Torsion field in which both torsion and curvature vary continuously, it is necessary to define torsion in *tensor* form. The Torsion two form can be defined as,

$T(X,Y) = (1/2) \exp(T(X,Y))$  Using torsion tensor  $T^h_{ij}$ , it can also be defined as  $t^h = 1/2 e^h * T^h_{ij}$

$dx^i dx^j$ . Where  $*$  is tensor product. Torsion Tensor is a skew symmetric tensor of rank 1,2.



Torsion is related to the affine connection '∇' by the equation (in differential manifold M),

$$T(X, Y) = \nabla_X Y - \nabla_Y X - (X, Y)$$

where  $X, Y \in (M)$ .

Displacement of the connection  $\Omega^h$  is also given by the equation  $\Omega^h = T^h_{ij} dx^i dx^j$

obtained from  $\Omega^h = dw^h + \theta^h_j w^j$ . Where  $\theta^h_j$  are connection forms for  $\acute{\Gamma}$ , Cristoffel

symbols. Torsion tensor  $T^h_{ij}$  equal to the difference in the 'asymmetric' christoffel

$$\text{symbols. } \acute{\Gamma}^h_{ij} \text{ and } \acute{\Gamma}^h_{ji} \text{ i.e. } T^h_{ij} = \acute{\Gamma}^h_{ij} - \acute{\Gamma}^h_{ji}.$$

In extremely weak QG field (or in weak EVAF), the acceleration 'a' may be defined by the equation,

$$a = d^2x^h/ds^2 = -\acute{\Gamma}^h_{ij} (dx^i/ds) (dx^j/ds) \tag{17}$$

Where  $\acute{\Gamma}^h_{ij}$  is asymmetric christoffel symbols with 64 components. The above equation (17) determines acceleration in case of Inertial frames performing EVA motion, as Inertial frames are extremely weak EVAF and in them the velocity attainable will be far below relativistic. But in case of QG field which is very strong EVAF and in which the acceleration changes fast, resulting in the fast attainment of relativistic velocity, the above equation (17) is inadequate to determine the acceleration attained. In such cases, 'change' in acceleration is determined rather than the acceleration itself due to exponential increase in the spin energy of the QG field, in the following way.

The commutator of a vector field V is  $(\nabla X, \nabla Y) = \nabla_X \nabla_Y - \nabla_Y \nabla_X = V; YX$ .

If two geodesics are parallel to each other, then the acceleration between them can be calculated from the Reimannian curvature tensor (RCT) by calculating acceleration at some point P, Q on each geodesic and subtracting them;

$$\text{i.e. } d^2w^h/ds^2 = d^2x^h/ds^2 \big|_Q - d^2x^h/ds^2 \big|_P = -\acute{r}^h_{ook} w^k \tag{18}$$

Where  $x^h$ =coordinate point along both geodesics

$w^h$ =connecting vector between the two geodesics.

$s$ = affine parameter on the geodesics.

$w^k$ =change in the component of  $w^h$ .

The full second covariant derivative along ‘V’ would be,

$$\nabla X \nabla Y w^h = (\dot{\Gamma}^h_{k00} - \dot{\Gamma}^h_{00,k}) w^k = R^h_{00k} w^k = R^h_{ijk} V^i V^j w^k \quad (19)$$

Where  $R^h_{ijk}$  is the RCT of rank 1,3.It *measures* difference in acceleration, as geodesics do not maintain their separation in curved space.

Now the basic field equations of QG (or LS), in tensor form, is given below;

$$R^h_{ijk} \alpha^k - \gamma_{ijk} \alpha^k \beta^h = \omega S^h_{ij} \quad (20)$$

Or

$$R^h_{ijk} \alpha^k - T^h_{ij} = \omega S^h_{ij} \quad (21)$$

Where  $R^h_{ijk}$  =Reimannian curvature tensor.

$\alpha^k$  =vector associated with the constant angle  $\alpha$  (or with ‘b’) of spin (or rotation) of LS with which it coils or uncoils.

$\gamma_{ijk}$  =Ricci’s rotation coefficients; which is skew-symmetric and is a scalar; it can also be in the form of rank 1,2 when it becomes con-torsion tensor  $K^k_{ij}$  with 24 components.

$\beta^h$  =vector associated with the rotation angle ‘ $\theta$ ’.

$S^h_{ij}$  =spin-energy tensor of rank 1,2.

Since the QG field (or LS path) is a spinning field, coiling inward, the value of  $S^h_{ij}$  depends on how fast the field is spinning.

$\omega = 16\pi G^2 / \check{G}C^4 = 2*10^{-62}$  /gm.cm/sec<sup>2</sup> i.e.  $\omega$  is in the units of ‘per force’. Therefore, ‘ $\omega$ ’ is an absolute constant of the QG field.

In LS, torsion tensor  $T^h_{ij}$  is related to the curvature tensor by the relation

$$1/2 R^h_{ijk} \alpha^k = T^h_{ij} \quad (22)$$

Substitution of this in the equation (21) yields

$$T^h_{ij} = \omega S^h_{ij} \quad (23)$$

This equation is reminiscent of Cartan's equation  $T^h_{ij} = \chi S^h_{ij}$ ; where  $\chi$  is Einstein's constant and  $\chi = 8\pi G/C^4 = 2 \times 10^{-48} \text{ /gm.cm/sec}^2$ . The meaning of other terms being the same as in the equation (23). Cartan has applied, as many physicists working on Torsion-Gravity have done, torsion to simple rotation of gravitating bodies. But torsion must be applied to 'spinning inward' bodies like BH, Quasars and the like which represent the QG field but 'not' to uniform rotating bodies describing gravitation, as this is evident from the ratio of  $\omega$  and  $\chi$ , which is equal to  $2G/\check{G}$  i.e.  $\omega/\chi = 2G/\check{G} = 10^{14}$ . This ratio reminds us of the strength of the gravitational field to that of the corresponding QG field. Torsion tensor  $T^h_{ij}$  is also described in terms of con-torsion tensor  $K^h_{ij}$ . But  $K^h_{ij}$  and  $\gamma_{ijk}$  are of the same forms.

Once the concept of torsion is applied to gravitation (i.e. uniform accelerated or gravity field), it becomes *distorted* i.e. the acceleration becomes varying and it varies exponentially and the gravitational field (as described by General Relativity (GR)) becomes EVAF (i.e. in this case it becomes QG field) and hence deviates from the 'predictions' of GR, signifying its breakdown. In the terminology of geometry, when torsion acts on a geodesic (describing gravitation) it (geodesic) will be 'deformed' in to a LS curve (describing QG field).

*6.3. Reduction of the basic QG field (or EVAF) equation in to Einstein's basic gravitational field equation; i.e. Reduction of,  $R^h_{ijk} \alpha^k - \gamma_{ijk} \alpha^k \beta^h = \omega S^h_{ij}$ . In to  $R_{ij} - 1/2 g_{ij} R = \chi T_{ij}$ .*

It is to be remembered that in LS, ‘b’ or ‘cot  $\alpha$ ’ represents the coiling or uncoiling of the LS and ‘ $\alpha$ ’ being the constant angle with which the LS coils or uncoils. Now if there is no coiling or uncoiling of the LS, which implies the absence of torsion, then ‘b’ (or cot $\alpha$ ) becomes zero i.e.  $b=0$  or  $\alpha =90^\circ$  and the LS becomes a circle and the path described, in the language of GR, would be a ‘geodesic’. Under such circumstances the component ‘k’ vanishes in the basic field equation of QG. At the same time the rotation angle ‘ $\theta$ ’ becomes uniform since the LS becomes a circle. i.e.  $R^h_{ijk} \rightarrow R_{ij}$ ;  $S^h_{ij} \rightarrow T_{ij}$  and  $\omega \rightarrow \chi$ .

Thus the basic field equation of QG,  $R^h_{ijk} \alpha^k - \gamma_{ijk} \alpha^k \beta^h = \omega S^h_{ij}$  is reduced to basic field equation of gravitation,  $R_{ij} - 1/2 g_{ij} R = \chi T_{ij}$ . Thus if ‘b’=0, the EVAF describing LS becomes uniform gravity (or accelerated) field of gravitation; i.e. if ‘b’ becomes zero, it implies that the torsion also becomes zero and the ‘geodesic torsion’, which measures the failure of a curve to be a ‘principle curve’ (i.e. geodesic) vanishes.

So to summarize, if torsion vanishes, QG field is reduced to the gravitational field i.e. the LS curve becomes a geodesic implying that the EVAF becomes uniform gravity field (or exponentially varying acceleration becomes uniform acceleration).

Under such circumstances, the constant of the QG field  $\omega = 16\pi G^2 / \check{G} C^4$  is reduced to the constant of the gravitational field  $\chi = 8\pi G / C^4$  as the ratio  $2G / \check{G}$  drops out.

6.4. *Relation between Schrodinger’s equation and the acceleration of the QG field (or of EVAF) in tensors;* Schrodinger’s equation which is at the basis of the Quantum Mechanics (QM) is expressed as

$$i \hbar (d\psi/dt) = H\psi = E\psi \quad (24)$$

Where  $\hbar$  = Planck's constant;  $i$  =imaginary unity;  $H$  =Hamiltonian expressing energy of the particle and  $H = - (\hbar^2/2m) \nabla^2 +U$ .  $\nabla^2$  =Laplacian operator  $\nabla^2\psi = (d^2\psi/dx^2) + (d^2\psi/dy^2) + (d^2\psi/dz^2)$ ;  $U$  =potential energy of the particle;  $m$  =mass of the particle;  $E$  = Total energy possessed by the particle.  $d\Psi/dt$  represents the 'evolution' of the  $\Psi$  function of the particle. It also means the 'frequency' of the particle with which the  $\Psi$  function is associated.

Since  $E\Psi$  represents the energy possessed by a quantum particle, it can be related to the acceleration 'a' possessed by it according to the second law of QG, i.e.  $E=ka$ . Where 'a' is the acceleration possessed by the particle either in EVAF (i.e.QG field) or in the gravitational field. Therefore,  $E\Psi=ka$ . Substituting in the equation (24) we get,  $i \hbar (d\Psi/dt) = ka$ . But  $\hbar/k = \check{C}$ .

$$\therefore i \check{C} (d\Psi/dt) = a \quad (25)$$

Since  $d\Psi/dt$  also represents the frequency 'v', i.e.  $d\Psi/dt = v$ , we get  $\hat{C} v = a$  or  $a = \hat{C} v$ . This is the relation that we have encountered already. In the equation (25), if 'a' is expressed in 'tensors', then in EVAF,  $a = (d^2x^h/ds^2) = -\hat{\Gamma}^h_{ij} (dx^i/ds)(dx^j/ds)$ . This is the equation (17) where  $\hat{\Gamma}^h_{ij}$  is asymmetric Christoffel symbols with 64 components. Substituting this value of 'a' in the above equation (25) we get,

$$i \check{C} (d\Psi/dt) = -\hat{\Gamma}^h_{ij} (dx^i/ds)(dx^j/ds). \quad (26)$$

This is how the evolution of a particle is determined in EVAF (or QG field). Here the evolution of the particle simply means evolution of its 'acceleration'. In the uniform accelerated field (i.e. the gravitational field),  $d\Psi/dt$  is found by the same equation(26); but here  $\hat{\Gamma}^h_{ij}$  represents the symmetric Christoffel symbols with 40 components. Since in the uniform accelerated field the acceleration is uniform, the evolution of the  $\Psi$  function of the particle is

also uniform as it possesses uniform energy in it. Under such circumstances the 4-coordinates of the  $\Psi$  function splits up in to 3-spatial and 1-time coordinates. Now the energy possessed by the particle in EVAF or gravitational field is expressed in tensor form as

$$i \hbar (d\psi/dt) = k (d^2x^h/ds^2) = k \{-\Gamma_{ij}^h (dx^i/ds)(dx^j/ds)\}. \quad (27)$$

Where  $\Gamma_{ij}^h$  is either asymmetric or symmetric.

#### 6.5. Relation between the basic equation of the QG and the Schrodinger's equation of the QM:

The basic equation of QG, in tensor form, is the equation (23) i.e.  $T_{ij}^h = \omega S_{ij}$ .

In non-tensor form this may be expressed as

$$\sigma = \omega S \quad (28)$$

Where  $\sigma$  = radius of torsion (T) and in case of LS,  $\sigma = 1/T$ ; S = Total spin energy of the BH.

This equation (28) is expressed in the form

$$S = \varpi \sigma \quad (29)$$

where,  $\varpi = 1/\omega = M\check{g}$ . Here M=mass of the BH;  $\check{g}$  = gravity possessed by the BH due to QG force at the center. For any BH, the product of  $M\check{g}$ , the total force exerted by the BH due to QG is always a constant.  $\check{g} = \check{G} M/2R^2$  and 'R' is the radius of the BH. Therefore,  $\varpi = \check{G}M^2/2R^2$ . For any BH,  $(M/R) = C^2/2G$ ,  $\therefore (M^2/R^2) = C^4/4G^2$ .  $\therefore \varpi = \check{G}C^4/8G^2 = 3.2*10^{62}$  gm.cm/sec<sup>2</sup>.

The  $\varpi$  is expressed in the units of 'force' and is an absolute constant. If  $2\pi$  is used in the denominator then the value of  $\varpi = (\check{G}C^4/16\pi G^2) = 5*10^{61}$  gm.cm/sec<sup>2</sup>.

The basic equation of QM is the Schrodinger's equation as expressed in the equation (24)

i.e.  $i \hbar (d\Psi/dt) = E\Psi$ . If we are to form a relationship between the basic equation of QG and that of QM, we have to reduce the former equation in to the latter equation in the following way.

'S' represents the total spin energy possessed by a BH; where as 'E', in the latter equation, represents the individual energy possessed by a single particle in the electro-magnetic (EM) field. Let us suppose that 'E' represents the energy of the particle in the QG field. Then the evolution of the ' $\Psi$ ' function i.e.  $d\Psi/dt$  represents the evolution of the energy 'E' of the particle in the QG field. But in the QG field, the energy  $E^Q$  possessed by a particle is given by the relation  $E^Q = 2F^Q R$ ; where R is the radius of the BH and  $F^Q$  is the force experienced by the particle in the QG field according to the first law of QG i.e.  $F^Q = \check{G}Mm/2R^2$  and  $F^Q = m \check{g}$ ; where 'm' is the mass of the particle manifested at the surface( or event-horizon) of the BH as a result of the free gravitational energy  $E_g$  available to it due to the gravitational interaction according to the relation  $E_g = mC^2 = 2F_g R$ ; where ' $F_g$ ' is the gravitational force experienced by the particle of mass 'm' at the surface of the BH where it is manifested and ' $E_g$ ' is the energy corresponding to mass 'm'. So we can identify ' $E^Q$ ' with 'E'. i.e.  $E^Q = E$ . Now we have to express the total spin energy 'S' possessed by a BH due to QG field 'in terms' of the energy  $E^Q$ (or E) possessed by a single particle in it. So if 'n' is the number of particles present in the BH, then ' $n \cdot E$ ' represents the total spin energy 'S' of the BH; i.e.  $n \cdot E = S$ . The value of 'n' is found out by the ratio of M/m i.e.  $n = M/m$ . As the mass 'M' of the BH increases, 'm' decreases correspondingly hence 'n' increases by the ratio of increase in 'M' to the corresponding decrease in 'm'. As 'M' increases, 'S' increases correspondingly, although 'E' decreases correspondingly. Therefore,  $n \cdot E = M/m$  i.e.  $S \cdot m = E \cdot M$ . Since  $E = (\check{G}/2G) mC^2$ , substituting in the above equation,  $S \cdot m = E \cdot M$  we

get,  $S = (\check{G}C^2/2G) M$ . That is how the total spin energy of the BH is related to its mass. But  $M = C^2R/2G$ ;

$$\therefore S = (\check{G}C^4/4G^2) R \quad (30)$$

But we know that ' $S = \varpi \sigma$ ', where  $\varpi = \check{G}C^4/8G^2$ ;

$$\therefore S = (\check{G}C^4/8G^2) \sigma \quad (31)$$

Comparison of both these equations (30) and (31) shows that,  $\sigma = 2R$ ; that is the radius of torsion ' $\sigma$ ' is twice the value of the radius ' $R$ ' of the BH. The path described in the BH due to the QG field is LS path and its characteristic is ' $b$ ' (or  $\cot \alpha$ ) i.e. the rate of inward turning of the path in LS. In LS, it is to be noted that the radius of torsion ' $\sigma$ ' is related to ' $R$ ' the radius of the BH by the relation  $\sigma = s = R (1+1/b^2)^{1/2}$  where ' $s$ ' is the arc-length of the LS path. Since for BH,  $\sigma = 2R$ , we get,  $2 = (1+1/b^2)^{1/2}$ ; i.e.  $4 = 1+1/b^2$ ;  $\therefore b^2 = 0.3333$  and  $b = 0.5774 = \cot \alpha$ . Therefore,  $\alpha = 60^\circ$ . This angle ' $\alpha$ ', the constant angle of turning, must be same for all BH and Quasars irrespective of their masses. Hence all BH and Quasars which characterize spiral growth of galaxies evolve with the same angle of  $60^\circ$ . That is the arms of all such spiral galaxies will be 'protruded' at the same angle of  $60^\circ$ . Now if we substitute the constant value of  $b = 0.5774$  in the equation (16) i.e.  $b n = 0.223$ , which is in turn obtained from the equation (15) i.e.  $a/a_0 = \exp(2\exp(4\pi bn))$ , we get constant value for ' $n$ ' i.e.  $n = 0.223/b = 0.223/0.5774 = 0.386$ . This value of ' $n$ ' = 0.386 is constant for all BH; since  $n = n_R - n_0$ , it means that the number of rotations ' $n$ ' made between  $n_R$  corresponding to  $\theta_R$  and  $n_0$  corresponding to  $\theta_0$  is always same for all BH in the QG field. In other words, the value of ' $n$ ' between  $R$  and  $R_0$  is always a constant for any BH. We get an interesting value for ' $n$ ', if we apply the value of  $b = 0.5774$  to the constant value of ' $bn$ ' obtained from the equation (14) to which the 'spinors' are *not* applied.



The value of 'bn', obtained from the equation (14) for a BH, is 'bn' =0.557;so for 'n' we get the value of  $n \cong 1$ . i.e. for any BH in the QG field only one rotation ( $n = 1$ ) is made between 'R' and 'R<sub>0</sub>'(or between  $\theta$  and  $\theta_0$ ). Now, let us compare the total spin energy 'S' of the BH with the energy 'E' possessed by the particle in it. Since,  $S = \varpi \sigma = 2\varpi R$  and  $E = 2 F_Q R$ , combining we get  $S = \varpi E/F_Q$ . i.e.  $(S/\varpi) = (E/F_Q)$ . This is how 'S' is related to 'E'.

It is to be noted that the force ' $\varpi$ ' is an absolute constant where as its counterpart ' $F_Q$ ' isn't so as it is a variable, varying from BH to BH. Even in the same BH,  $F_Q$  varies (increases) along the LS path as the particle moves from the surface of BH towards its center. So does 'E' of the particle as well as 'S'. Since,  $E = i \hbar (d\psi/dt)$  and  $E = (S F_Q)/\varpi$ , it follows that,

$$i \hbar(d\psi/dt) = (S F_Q)/\varpi \quad (32)$$

This is the sort of relationship that exists between the Schrodinger's equation and the QG field.

*6.5.1.The meaning of ' $\chi$ ', the Einstein's constant of the gravitational field;* Since in the field equation of gravitation,  $R_{ij} - 1/2 g_{ij} R = \chi T_{ij}$ , the value of  $\chi = 8\pi G/C^4 = 2*10^{-48} /gm.cm/sec^2$ , i.e. it represents per force as does ' $\varpi$ ' in the QG field. So the inverse value of  $\chi$  i.e.  $\chi'$  is,  $\chi' = 1/\chi$  represents the force of the gravitational field. But this force  $\chi'$  is in fact the total force of the gravitational field of the BH and is always a constant for that matter for any BH irrespective of its mass. This can be shown as follows; if 'F' is the gravitational force exhibited by a BH, then  $F = Mg$ , where M=mass of the BH and g=surface gravity of the BH. But,  $g = GM/R^2$   $\therefore F = GM^2/R^2$ . In case of BH,  $M/R = C^2/2G$ ,  $\therefore M^2/R^2 = C^4/4G^2$ , substituting this in the equation  $F = GM^2/R^2$  we get  $F = C^4/4G$ . Now if the denominator is multiplied by  $2\pi$  (a geometrical entity) we get  $F = C^4/8\pi G$ . This is nothing but the value of  $\chi'$ . Therefore,  $F = \chi' = C^4/8\pi G$ . The reciprocal of this is  $\chi$  i.e. the Einstein's constant of the gravitational field. Since this is an absolute constant, it is

independent of the mass of the BH, which exhibits the gravitational force. This also shows that the force of gravitation 'F' is the same for all BH and is an absolute constant and is nothing but  $\chi'$  i.e.  $F=\chi'=1/\chi$ .

## **Part 2. Quantum- Mechanics.**

### **7. Exponentially Varying Accelerated Field (EVAF)**

We have already discussed how acceleration varies in EVAF when applied to both QG field and EM field. That is,  $a = a_0 \exp (x/x_0)$  if the acceleration is increasing and  $a = a_0 \exp (-x/x_0)$ , if the acceleration is decreasing.

In the Black Hole Chart, variation of the acceleration is independent of the mass of the particle moving in it but it solely depends on the radius of the Black Hole. But in EM field, variation of the acceleration depends not only on the force of the field but it also depends on the mass of the particle moving in it. So is the case with the QG field when applied to the IT.

#### *7.1. Fields Involving Unitary change in Acceleration*

Let us consider what happens when there is unitary change in acceleration i.e. when acceleration changes in a single jump as in atomic, molecular, etc., transitions. This unitary change in acceleration corresponds to quantum jump and hence to quantum mechanics (QM). So this unitary change in acceleration is applicable only to micro particles but not to macroscopic test bodies as it can be seen later. Unitary change in acceleration implies quantized acceleration and this is equivalent to quantized energy. We have seen that the path described by a jet of particles in EVAF is logarithmic spiral and a stream of particles or an individual particle in EVAF describes conical spiral path. Thus the space will be *twisted in to a*

*spiral* in EVAF. Now we will consider what happens to particles when they are subjected to unitary change in acceleration and what happens to space in it. *The force, which produces change in acceleration, is a Torres -forming force.* Thus the space and the particles in it are subjected to Torsion and consequently will be *stretched*. The magnitude of stretching will depend on the magnitude of the acceleration being changed and consequently upon the change in the energy of the particle. The magnitude of stretching depends on two factors. 1) *On the magnitude and nature of the force acting and 2) on the mass of the particle being stretched.* If the force acting is the QG force, the magnitude of stretching is independent of the mass of the particle; for, all particles irrespective of their masses will be stretched by the same magnitude. If the force acting is the EM force, the magnitude of stretching depends also on the mass of the particle and being different for particles of different masses in the same EM field.

The energy of the particle or change in the energy of the particle ‘E’, is related to its magnitude of stretching ‘l’, by the relation “ $E = f_i l$ ”, where ‘ $f_i$ ’ is the ‘inertial force’ displayed by the particle. This “inertial force” ‘ $f_i$ ’ plays an important role in quantum energy transitions and is related to the rest mass ‘m’ of the particle by the relation  $f_i = ma_0$ , where ‘ $a_0$ ’ is the constant value of acceleration and its value is  $a_0 = 3.33 * 10^{22}$  cm/sec<sup>2</sup>. This value of ‘ $a_0$ ’ is found at the interaction range of  $10^{-23}$  cm in the IT for  $w^\pm$  particle. At this range of  $10^{-23}$  cm, the value of acceleration  $a_0$  is according to the relation,  $a = a_0 = \pi\check{G}\beta/2r = 3.33*10^{22}$  cm/sec<sup>2</sup>. This range i.e.  $10^{-23}$  cm is the range at which strong force is unified with the Electro-weak force forming the Grand Unified Force corresponding to energy  $6.6*10^{17}$ ev i.e.  $6.6*10^8$  Gev by  $w^\pm$ .

The value of ‘ $f_i$ ’ is invariant for a particular particle as long as its rest mass remains *invariant*. The value of ‘ $f_i$ ’ for electron  $e^-$  is  $f_{ie^-} = 3*10^5$  erg/cm =  $1.9 * 10^7$  ev/cm; for proton  $p^+$ ,  $f_{ip^+} = 3.5*10^{10}$ ev/cm i.e. 1836 times higher than what it is for  $e^-$ . For  $w^\pm$  particle, it is about 95 times higher than that of the  $p^+$  i.e.  $f_{iw^\pm} = 3.3*10^{12}$  ev/cm. Thus as the rest mass of the particle

increases its value of  $f_i$  correspondingly increases and according to the equation “ $E = f_i \lambda$ ”, for the same energy transition ‘E’ by particles of different masses, the value of ‘ $\lambda$ ’ will be different i.e. if the mass of the particle is higher, the value of ‘ $\lambda$ ’ is smaller and vice-versa. Thus for the same value of energy E, an electron ( $e^-$ ) is stretched 1836 longer than a proton ( $p^+$ ) as the mass of the  $p^+$  is 1836 higher than that of the  $e^-$ . Now in the same EM field, the  $e^-$  possesses 1836 times higher energy ‘E’ than the  $p^+$  and the value of the ratio of  $\lambda_e/\lambda_{p^+}$  would be  $(1836)^2$

i.e.  $\lambda_e/\lambda_{p^+} = (1836)^2$ . Thus the  $e^-$  is stretched by a factor of about  $3.35 * 10^6$  times higher than the  $p^+$  in the same EM field. So as the mass of the particle increases, its quantum properties decreases as more and more energy is required to make it under go quantum transition, against its Inertial force ‘ $f_i$ ’. That is why test bodies of classical size do not exhibit quantum properties. In EVAF or in the field of unitary change in acceleration, it is ‘ $f_i$ ’ of the particle, which offers resistance to it (particle) being stretched or in other words, undergo quantum energy transitions.

If we identify the relation  $E = f_i \lambda$  with the second law of Quantum Gravity i.e.  $E = ka$ , we get,  $ka = f_i \lambda$  i.e.  $ka = m \cdot a_0 \cdot \lambda$ .  $\therefore k/a_0 = m \lambda/a = 10^{-39} \text{ gm/sec}^2$ . Since both ‘k’ and ‘ $a_0$ ’ are constants, their ratio  $k/a_0 = 10^{-39} \text{ gm.sec}^2$  is also a constant.  $\therefore k/m \cdot a_0 = \lambda/a = 10^{-39}/m = t^2$ . i.e.  $k/a_0 = m t^2 = 10^{-39} \text{ gm.sec}^2$ . So it follows that,  $a t^2 = \lambda$ . This is how acceleration or unitary change in acceleration is related to ‘ $\lambda$ ’ (the magnitude of stretching of the particle).  $t^2$  is characteristic of a particular particle and remains invariant as long as the mass of the particle remains invariant. This is the case in quantum energy transition by particles in molecular, atomic (by  $e^-$ ), nuclear (by  $p^+$ ) etc. interactions. So  $t^2$  plays an equally important role, as does  $f_i$ . According to the equation  $m t^2 = 10^{-39} \text{ gm.sec}^2$ , the value of  $t^2$  decreases as the mass of the particle increases. For example, for  $e^-$ ,  $t_e^2 = 10^{-12} \text{ Sec}^2$ , for  $p^+$ ,  $t_{p^+}^2 = 6 \cdot 10^{-16} \text{ sec}^2$ ; for  $w^+$ ,  $t^2 = 6 \cdot 10^{-18} \text{ Sec}^2$ . It is important

to note that ' $k = f_i \cdot t^2$ '. That is the product of the two characteristics of a particle (or of any particle) is always a constant and that constant is the quantum gravity constant, ' $k$ '.

Now the question is, what is the maximum extent to which a particle can be stretched? That is what is the maximum value of ' $l$ '? This can be found out as follows; When a particle is stretched to its maximum i.e.  $l_{\max}$ , the energy of the particle according to the equation  $E = f_i l_{\max}$  becomes equal to its rest energy i.e.  $E = mC^2$ . Therefore,  $mC^2 = f_i l_{\max} = m a_0 l_{\max}$  as  $f_i = m \cdot a_0$ . Therefore,  $a_0 l_{\max} = C^2$  i.e.  $l_{\max} = C^2/a_0 = 2.7 \cdot 10^{-2}$  cm. where ' $C$ ' is the maximum velocity attainable by the particle. If the velocity of the particle is less than ' $C$ ', then  $l = v^2/a_0$ . Thus the maximum stretching of a particle  $l_{\max}$ , irrespective of its rest mass is  $2.7 \cdot 10^{-2}$  cm. The minimum value of ' $l$ ' i.e.  $l_{\min}$  also may be found out as follows. We know that from IT  $\check{a} = \pi \check{G} \beta / 2r$  and  $\check{a} = l/t^2$ . Combining both, we get  $l/t^2 = \pi \check{G} \beta / 2r$  i.e.  $r l = \pi \check{G} \beta t^2 / 2$ . For any particle  $\beta t^2$  is constant and  $\beta t^2 \approx 10^{-25}$  gm/cm/sec<sup>2</sup>. Therefore  $\pi \check{G} \beta t^2 / 2 = 2 \cdot 10^{-18}$  cm<sup>2</sup>. Therefore,  $r l = 2 \cdot 10^{-18}$  cm<sup>2</sup>. Since the maximum value of ' $r$ ', the interaction range, in IT is  $10^{-5}$  cm, the minimum value that  $l$  attains is  $l_{\min} = 2 \cdot 10^{-13}$  cm for any particle irrespective of its mass. Thus the maximum and minimum values of  $l$  are;  $l_{\max} = 2.7 \cdot 10^{-2}$  cm and  $l_{\min} = 2 \cdot 10^{-13}$  cm. It is within these values of  $l$  that a particle can make quantum energy transitions. When the stretching of the particle becomes maximum i.e.  $l_{\max} = 2.7 \cdot 10^{-2}$  cm, for any further increase in the energy of the particle, its mass becomes relativistic and starts increasing as in QG field, so that in the equations  $E = f_i l$  and  $a t^2 = l$ , it is ' $f_i$ ' of the particle which increases and  $t^2$  of the particle which correspondingly decreases, keeping the value of  $l_{\max}$  same. Thus a particle cannot be stretched longer than its maximum value of  $l_{\max} = 2.7 \cdot 10^{-2}$  cm. In other words  $l_{\max}$  of  $2.7 \cdot 10^{-2}$  cm is the limit. When  $l$  becomes maximum, it is to be noted that according to the equation  $r l_{\max} = 2 \cdot 10^{-18}$  cm<sup>2</sup>, the value of ' $r$ ' becomes equal to  $0.75 \cdot 10^{-16}$  cm i.e.  $r = 0.75 \cdot 10^{-16}$  cm. This is the interaction

range at which EM interaction merges (or unifies) with the weak interaction i.e. the Electro-weak interaction range, signifying that quantum jumps do no more take place below this interaction range. Now let us consider the reason why test masses of classical size cannot (and do not) undergo quantum energy transition; as their diameter exceeds the maximum value of  $l$  i.e.  $l_{\max} = 2.7 \cdot 10^{-2}$  cm. Even if they do possess diameter less than  $l_{\max}$ , it becomes impossible to make them undergo quantum energy transition, as their value of ' $f_i$ ' would be tremendously high which makes it impossible to attain such energy levels either in lab or under terrestrial conditions to make them undergo quantum energy transitions.

The maximum value of  $l$  i.e.  $l_{\max}$  may be also determined as follows. Since in the gravitational field, according to IT the acceleration ' $a$ ' is determined by the equation  $a = \pi G \beta / r$ , where ' $G$ ' is the gravitational constant, and  $a = l/t^2$ . So combining both, we get  $r l = \pi G \beta t^2 = 1.8 \cdot 10^{-32}$  cm<sup>2</sup> for any particle irrespective of its mass. Since the minimum value of ' $r$ ', the interaction range, is  $6.66 \cdot 10^{-31}$  cm according to IT, the maximum value of  $l$  i.e.  $l_{\max} = 2.7 \cdot 10^{-2}$  cm. And for the minimum value of  $l$  i.e.  $l_{\min} = 2 \cdot 10^{-13}$  cm, the maximum value of ' $r$ ' in IT corresponds to  $10^{-19}$  cm i.e.  $r_{\max} = 10^{-19}$  cm for the gravitational interaction. It is within this value of  $r_{\max}$  and  $r_{\min}$  that the gravity of Black Holes varies exponentially in the vicinity of them due to exponentially varying gravitational field. Due to this exponential variation of the gravitational field, the electromagnetic field is produced which also varies exponentially inducing quantum energy transitions in the particles which move towards the Black Hole and undergo EVA motion. The values of  $r_{\max} = 10^{-19}$  cm and  $r_{\min} = 6.66 \cdot 10^{-31}$  cm correspond to Black Hole radius " $R$ " equal to  $1.5 \cdot 10^{16}$  cm and  $10^5$  cm respectively. It is within this value of Black -Holes' radii that quantum energy transitions occur in their vicinity, although Black Hole chart allows for a maximum value of  $R = 3.7 \cdot 10^{17}$  cm of Black Hole to exist in the form of quasars.

In the QG field, all particles irrespective of their masses will have the same value for  $\hbar$ . Since the QG field is expressed by the IT and according to IT at a particular interaction range 'r' all particles will have energies corresponding to their rest masses (i.e. higher the rest mass of the particle, correspondingly higher will be the energy possesses by it) and hence the value of  $\hbar$  will be the same for them as it is evident from the equations  $E = f_i \hbar$  and  $r \hbar = \pi \check{G} \beta t^2 / 2$ . This latter equation also expresses the relationship between  $\hbar$  and the atomic radius 'r' (i.e. the interaction range and the atomic radius are the same) in case of Hydrogen atom ( $H^+$  atom).  $\hbar$  corresponds to stretching of the *proton* ( $p^+$ ) but *not* to that of the *electron* ( $e^-$ ) in the relation "E =  $f_i \hbar$ " where ' $f_i$ ' corresponds to  $p^+$ , only then do we find the transition values of energy 'E' of the  $H^+$  atom to correspond to empirically observed values. Therefore, we have to express the energy values (i.e. the spectrum) of the  $H^+$  atom in terms of the stretching of the  $p^+$  but not in terms of that of the  $e^-$ . Thus the *focus* shifts from  $e^-$  to  $p^+$ . If a number of protons of an atom participate in the interaction then, ' $f_i$ ' in the equation corresponds to the total mass of the number protons of that atom participating in the interaction.

' $\hbar$ ' is related to the wavelength ' $\lambda$ ' of the radiation emitted, according to the equation  $\hbar \lambda = 2\pi C \check{C} t^2$  which is obtained from the equations  $a t^2 = \hbar$  and  $\lambda = 2\pi C \check{C}$ .

What is the role-played by  $\hbar$  in explaining the atomic and molecular spectra?  $\hbar$  is associated with the *mass* of the particle, which emits the radiation and thus represents the *energy-lines* of the spectrum. At the same time, atomic and molecular energy transitions are to be explained in terms of stretching of the proton rather than in terms of that of the electron. The equations  $E = f_i \hbar$  and  $r \hbar = \pi \check{G} \beta t^2 / 2$  hold good not only for charge 'Z' being equal to unity (i.e.  $Z = 1$ ) but for any value of 'Z' (i.e. 5, 10, 20, etc.) and the above two equations do not require the presence of 'Z'.

*7.1.1. The meaning of  $t^2$* : The meaning of  $t^2$  can be known from the relation  $\hbar \lambda = t^2 C \check{C}$ . We know that,  $C/\lambda = \nu$ . Similarly it is possible for us to write  $\check{C}/\hbar = \check{\nu}$ . Where ' $\check{\nu}$ ' is the frequency

associated with the *vibrations* of the particles in the Quantum Gravity field or EVAF. In other words ‘ $\ddot{v}$ ’ is independent of the mass of the particle like the value of  $l$  and ‘ $\ddot{v}$ ’ represents the vibration of the QG field itself in which the particles are present. Thus  $t^2$  is written as,  $t^2 = 1/v\ddot{v}$ . Thus  $t^2$  is reciprocal of the product of the two frequencies; one frequency ‘ $v$ ’ is associated with the radiation emitted by the particle and another one ‘ $\ddot{v}$ ’ is associated with the vibration of the particle in the field. Since for  $e^-$ ,  $t^2 = 10^{-12} \text{ sec}^2$ . So,  $v\ddot{v} = 10^{12} \text{ vib/sec}^2$ ; for  $p^+$   $t^2 = 5.4 * 10^{-16} \text{ sec}^2$ , so  $v\ddot{v} = 1.84 * 10^{15} \text{ vib/sec}^2$ , and for  $w^\pm$  particle,  $t^2 = 5.7 * 10^{-18} \text{ sec}^2$ , so  $v\ddot{v} = 1.75 * 10^{17} \text{ vib/sec}^2$ . The product ‘ $v\ddot{v}$ ’ remains invariant as long as the value of  $t^2$  remains invariant. If the mass of the particle emitting the radiation becomes relativistic,  $t^2$  varies (decreases) and the product of  $v$  and  $\ddot{v}$  i.e., ‘ $v\ddot{v}$ ’ also varies (increases). In quantum energy transition, since the mass of the particle is non-relativistic, the product of ‘ $v\ddot{v}$ ’ remains invariant.

$\ddot{v}$  like  $l$  is also having maximum and minimum values within which it varies. These values for  $\ddot{v}$  may be calculated with the help of the expression,  $l\ddot{v} = \check{C}$ . Since  $l_{\text{max}} = 2.7 * 10^{-2} \text{ cm}$ ,  $\ddot{v}_{\text{min}} = 1.2 * 10^{-9} \text{ vib/sec}$  and  $l_{\text{min}} = 2 * 10^{-13} \text{ cm}$ ,  $\ddot{v}_{\text{max}} = 1.7 * 10^2 \text{ vib/sec}$ . Thus the value of  $\ddot{v}$  varies between the minimum and maximum value of  $1.2 * 10^{-9} \text{ vib/sec}$  and  $1.7 * 10^2 \text{ vib/sec}$ . So in the equation  $t^2 = 1/v\ddot{v}$ , even if the mass of the particle becomes relativistic it is ‘ $v$ ’ and ‘ $t^2$ ’ which vary (i.e.  $v$  becomes higher and  $t^2$  becomes correspondingly smaller) but not  $\ddot{v}$  as it has attained its minimum value. Similarly when  $\ddot{v}$  has attained its maximum value i.e.  $1.7 * 10^2 \text{ vib/sec}$ , it cannot be increased further because ‘ $v$ ’ has reached its minimum value according to IT.

### 7.2. A comparison between the force acting on a particle and its [particle’s] Inertial force [ $f_i$ ]:

When does the force “F” acting on a particle is comparable to its (particle’s) inertial force,  $f_i$ ?

Here the force ‘F’ is the force represented as such in the IT and Black Hole chart representing the force of the QG (i.e.  $F = F_Q$ ) and the inertial force ‘ $f_i$ ’ is the force possessed by a particle



and is responsible for preserving the *identity* of the particle and as well as in *determining* its 'quantum energy' transitions. The equation corresponding to this comparison may be derived as follows.

We know that  $E = ka$ ,  $k = f_i t^2$  and  $f_i = m a_0$ . Combining we get  $E = m a_0 t^2 a$ . Here the product of 'm a' is the force 'F' acting on the particle of mass 'm' i.e.  $F = m a$ . Therefore we get  $E = F a_0 t^2$ . Here 'E' is the energy possessed by the particle due to force 'F' acting on it.

Now if this energy 'E' of the particle is equal to its quantized energy, i.e. the energy lost or gained by the particle in a jump according to the equation  $E = f_i \lambda$ , then  $f_i \lambda = F a_0 t^2$ . But  $\lambda/t^2 = a$ . Therefore,  $f_i a = F a_0$ . This is the sort of relationship that exists between 'f<sub>i</sub>' and F(or F<sub>0</sub>). This equation may be written as  $F/f_i = a/a_0$ . For lower values of acceleration 'a' the value of 'F' is too low compared to 'f<sub>i</sub>' because 'a<sub>0</sub>' which is a constant is very high i.e.  $a_0 = 3.3 * 10^{22}$  cm/sec<sup>2</sup>. So at values of 'a' comparable to a<sub>0</sub>, 'F' is comparable to f<sub>i</sub>. If  $a = a_0 = 3.3 * 10^{22}$  cm/sec<sup>2</sup>. 'F' becomes equal to 'f<sub>i</sub>' i.e.,  $F = f_i$ . At this acceleration 'a', the energy possessed by the particle would be about 10<sup>18</sup> ev (10<sup>9</sup> Gev) at the interaction range of about 10<sup>-23</sup> cm by w± particle. At this range Electro-weak force merges with the strong force forming the GUT's force. If the acceleration is further increased and becomes far higher than 'a<sub>0</sub>' i.e.  $a \gg a_0$ , then 'F' correspondingly becomes higher than 'f<sub>i</sub>', i.e.  $F \gg f_i$ . This comparison between the two forces 'F' and 'f<sub>i</sub>' becomes maximum at the interaction range of  $6.66 * 10^{-31}$  cm according to IT. This is also the minimum range attainable according IT. At this range of IT the ratio of  $F/f_i$  becomes equal to about 10<sup>7</sup> i.e.  $F/f_i = 10^7 = a/a_0$ . So the force 'F' acting on the particle (whose inertial force is 'f<sub>i</sub>') is far too stronger than 'f<sub>i</sub>' and simply over powers it and thereby making the particle to loose its initial identity. Under such circumstances, according to the relation  $ka = mC^2$ , possession of the acceleration 'a' results in the manifestation of mass 'm', since the value of 'a' is extremely high i.e. maximum (of the order of  $5 * 10^{29}$  cm/sec<sup>2</sup> at the range of  $6.66 * 10^{-31}$

cm by  $w^{\pm}$  particle) the corresponding mass manifested will be of the order of  $1.5 * 10^{-8}$  gm as  $m/a = k/C^2 = 3.5 * 10^{-38}$  gm/cm/sec<sup>2</sup> i.e.  $m = 3.5 * 10^{-38} a$  or  $a = 2.8 * 10^{37}m$ . Substituting this in the relation  $F = ma$ , we get the relationship between the force 'F' acting and the mass 'm' being manifested or the acceleration 'a' being produced. So  $F=2.8*10^{37} m^2$  and  $F = 3.5*10^{-38} a^2$ . Now substituting energy 'E' for either 'm' or 'a' according to the equations  $E = mC^2$  or  $E = k a$ , we get,  $F = 3.5*10^{-5} E^2$ . That is expressing the relationship between the force 'F' acting and the energy 'E' manifesting corresponding to that force.

### 7.3. *Basic Equation Governing Atomic Energy Transitions And Its Relation To Exponentially Varying Accelerated Field:*

The basic equation governing atomic energy transitions is based on two themes. They are (1) Radiation emittance of a Black body and (2) Radiation emittance in Bremsstrahlung. Certain aspects of these two ideas are combined in deriving the basic equation.

We know from blackbody radiation that the "Wein's Displacement Law" is,  $T \lambda_{max} = b = 0.29$  cm°K where 'T' is the temperature of the black body and  $\lambda_{max}$  is the wavelength at which maximum of emission takes place. This also may be interpreted as minimum energy 'threshold'.

It is also known from 'bremsstrahlung' that a particle (especially electron  $e^-$ ) accelerated to certain energy (maximum) will have a definite minimum wavelength,  $\lambda_{min}$  and when it undergoes bremsstrahlung emits radiation (energy) exponentially. The relation between maximum energy possessed by the particle and the wavelength  $\lambda_{min}$  corresponding to it is obviously  $E_{Max} = hc / \lambda_{min} = ka$ . Therefore,  $a \lambda_{min} = hc/k = C\check{C} = 1$  cm<sup>2</sup>/sec<sup>2</sup>. From Boltzmann's equation we know that  $E = KT$ . where 'T' is the Temperature and K is the Boltzmann's constant. But  $E = ka$ ,

according to the second law of QG. So combining both equations we get,  $ka=KT$  i.e.  $T = ka/K$ .

Substituting for 'T' in the equation  $T \lambda_{\max} = b$ , we get a  $\lambda_{\max} = (Kb/k) \text{ cm}^2/\text{sec}^2 = 1.3 \text{ cm}^2/\text{sec}^2$ .

Similarly  $a = KT/k$ . Substituting for 'a' in the equation  $a \lambda_{\min} = C\check{C} = 1$ . We get,  $T \lambda_{\min} = kC\check{C}/K = 0.22$ . Now dividing equation  $T \lambda_{\max} = b = 0.29$  from  $T \lambda_{\min} = 0.22$ , we get  $\lambda_{\max} / \lambda_{\min} = 0.29/0.22=1.3$ . Similarly dividing the equation  $a \lambda_{\max}=1.3$  from a  $\lambda_{\min}= C\check{C} =1$  we get,  $\lambda_{\max} / \lambda_{\min} = 1.3$ . Thus we get same result in both cases. But we know that  $\lambda_{\max} / \lambda_{\min} = E_{\max} / E_{\min} = 1.3$  where  $E_{\min}$  is the minimum energy emitted or absorbed corresponding to the value of  $E_{\max}$  possessed by the atom. This maximum energy  $E_{\max}$  obviously corresponds to ground state energy of the atom. If the atom is in different phases or stages while emitting or absorbing, the ratio of  $\lambda_{\max} / \lambda_{\min}$  also correspondingly changes. So the general form of the ratio being  $\lambda_{\max} / \lambda_{\min} = 1.33^{n_Q}$ , where 'n<sub>Q</sub>' is the number of phases or stages of emission or absorption of energy levels, through which the atom undergoes. So 'n<sub>Q</sub>' assumes only integer values. The values of n<sub>Q</sub> are, n<sub>Q</sub> = 1,2,3,etc., and the atom must be in a definite phase or state while emitting or absorbing the energy. Therefore the basic equation for energy transitions in atoms, molecules, etc., can be written as follows.

$$E_e = - (E/1.33^{n_Q}) \text{ or } E_e = -E * 1.33^{-n_Q} \quad (33)$$

– (Minus) sign indicates the direction in which the energy is emitted i.e. in the opposite direction. 'E' is the initial energy possessed by the atom, 'E<sub>e</sub>' is the minimum energy emitted or absorbed by the atom corresponding to 'E'. The factor  $1.33 = \lambda_{\max} / \lambda_{\min}$ . In the ground state  $n_Q = 1$ . n<sub>Q</sub> is related to the principal quantum number 'n' of QM by  $n_Q = n-1$ . So if  $n = 1$ ,  $n_Q = 0$  and there is no energy transition by the atom. If there is to be energy transition then the minimum value of 'n<sub>Q</sub>' must be one i.e.  $n_Q = 1$ ; then 'n' will be two, i.e.  $n = 2$  and this is the minimum

value of 'n' to be taken if there is to be energy emission by the atom. So the conception  $n_Q = 1$  is that it is the 'phase stage' between  $n = 1$  and  $n = 2$ , like wise, the conception of  $n_Q = 2$  is that it is the 'phase stage' between  $n = 2$  and  $n = 3$ . In this way the concept of 'n<sub>Q</sub>' is formulated. Now let us apply this conception and formula (34) to hydrogen atom (H<sup>+</sup>).

In the ground state the energy 'E' possessed (it is termed  $E_G$  or  $E_1$ ) by the H<sup>+</sup> atom is 13.6 ev (maximum energy possessed). In this state the value of  $n_Q = 1$  i.e.  $n_Q = 1$ . So the value of minimum energy  $E_{e1}$  emitted or absorbed will be  $E_{e1} = 13.6/1.33^{n_Q} = 13.6/1.33 = 10.2$  ev. So 10.2 ev is the minimum transition energy in the ground state for the H<sup>+</sup> atom. This coincides with the value obtained from QM between the ground state (i.e.  $n = 1$ ) and the very next one (i.e.  $n = 2$ ). Similarly the minimum energy transition in the next phase or state (i.e. second state) at which  $n_Q = 2$ , will be  $E_{e2} = E_2/1.33^2 = 3.4/1.79 = 1.9$  ev. Here  $E_2 = 3.4$  ev is the energy possessed by the H<sup>+</sup> atom in its second state at which  $n_Q = 2$ . The minimum energy  $E_e$  emitted or absorbed will be 1.9 ev at this state also coincides with the one calculated from the QM between levels  $n = 2$  and  $n = 3$ . Likewise for the next state minimum energy emitted or absorbed (where  $n_Q = 3$  and  $E_3 = 1.5$  ev) will be,  $E_{e3} = 1.5/1.33^3 = 1.5/2.35 = 0.65$  ev. In this way we can calculate the value of  $E_e$  for any value of 'n<sub>Q</sub>' and see that it coincides with the one calculated from QM. This method can be applied to any atom to calculate its energy levels and we see that its values coincide with the ones obtained from QM. The minimum energy emitted or absorbed at any phase or stage is given in general by equation

$$E_e = - E / \{n_Q^2 \cdot 1.33^{n_Q}\} \quad (34)$$

Where 'E' is the maximum ground state energy possessed by the atom. The total energy 'E<sub>eT</sub>' emitted is given by the equation:  $E_{eT} = - \{E + [E/(n_Q^2 \cdot 1.33^{n_Q})] - E/n_Q^2\} = E \{1 - 1/n_Q^2 (1 - 1/1.33^{n_Q})\}$

$$\therefore E_{eT} = -E/n_Q^2 \{n_Q^2 + (1/1.33^{n_Q}) - 1\} \quad (35)$$

Where 'E' is the initial or ground state (i.e. maximum) energy of the atom. The value 'E' for any atom can be known from the IT. Another way of writing the equation for  $E_{eT}$  based on QM is  $E_{eT} = -(E-E/n^2)$ . On comparison of this equation with the above one for  $E_{eT}$ , we find that

$$1/n^2 = 1/n_Q^2 (1 - 1/1.33^{n_Q}): \text{i.e.}$$

$$n = n_Q / (1 - 1/1.33^{n_Q})^{1/2} = n_Q + 1. \quad (36)$$

#### 7.4. Conversion of basic Equation of Atomic Energy Transition in to its Exponential Form:

The basic equation of atomic energy transition  $E_e = -E/(n_Q^2 * 1.33^{n_Q})$  is converted into its exponential form so as to bring not only atomic energy transition but also unitary change in acceleration (and hence of energy) under the scope of exponentially varying accelerated field (EVAF). The exponential law describing atomic energy emission is given in the form

$$E_e = E_p e^{-y} \quad (37)$$

Where 'E<sub>e</sub>' is the energy emitted, E<sub>p</sub> is the energy possessed by the atom at any phase or stage n<sub>Q</sub>, at the time of emission. The exponential function 'e<sup>-y</sup>' is related to  $(\lambda_{max} / \lambda_{min})_{n_Q} = 1.33^{n_Q}$  in the following way,  $e^{-y} = 1/1.33^{n_Q}$  i.e.  $e^y = 1.33^{n_Q}$  or  $e^{-y} = 1.33^{-n_Q}$  where  $e = 2.72$ . Conversion of the bases gives  $y = 0.287 n_Q$  or  $n_Q = 3.484 y$ . So  $e^y = \exp(0.287 n_Q)$ . Therefore,  $E_e = E_p \exp(-0.287 n_Q) = E_p e^{-y}$ . The energy 'E<sub>p</sub>' possessed by the atom at any phase or stage 'n<sub>Q</sub>' is related to the initial or ground state energy 'E' of the atom by the relation  $E_p = E/n_Q^2$ . So we can write the above equation  $E_e = -E_p e^{-y}$  in the form  $E_e = -(E e^{-y} / n_Q^2) = -(E/n_Q^2) \exp(-0.287 n_Q)$ . This equation gives the energy emitted at the state corresponding to the value of 'n<sub>Q</sub>' only. In

order to calculate the total energy ‘ $E_{eT}$ ’ emitted by the atom, first the energy possessed ‘ $E_p$ ’ is found out by the formula  $E_{p,nQ} = (E/n_Q^2) (1-e^{-y})$ . Now the total energy ‘ $E_{eT}$ ’ emitted by the atom is  $E_{eT} = (E - E_{pnQ})$  i.e.  $E_{eT} = \{E - (E/n_Q^2)(1-e^{-y})\}$ . Therefore  $E_{eT} = E \{1 - [(1/n_Q^2)(1-e^{-y})]\}$ .

The relationship between the principal quantum number ‘ $n$ ’ and ‘ $y$ ’ is, since  $n = n_Q + 1$  and  $y = 0.287 n_Q$ ,  $n = 1 + y/0.287$  or  $n = 1 + 3.484 y = 3.484 y / (1 - e^{-y})^{1/2}$  or  $y = 0.287(n - 1)$ . From the above considerations it also follows that:

$$e^{-y} = (2n_Q + 1) / (n_Q + 1)^2 = (2n - 1) / n^2. \quad (38)$$

In all these cases, the value of ‘ $n$ ’ must be always greater than one i.e.  $n > 1$  and must be equal to  $n = 2, 3, 4$ , etc. Because if  $n < 2$  i.e. if  $n = 1$  then  $n_Q = 0$  and therefore there is no energy transition. The energy values for  $H^+$  atom can be expressed in the form of a table.

**Table 5.**

$n_Q$	$n$	$y$	$e^y$	$e^{-y}$	$E_p$ ev	$E_e = E_p e^{-y}$
1	2	0.28	1.33	0.75	13.6 ev	10.2 ev
		7				
2	3	0.58	1.79	0.55	3.4 ev	1.9 ev
3	4	0.86	2.4	0.42	1.5 ev	0.64 ev
4	5	1.15	3.16	0.32	0.85 ev	0.30 ev

## 8. The Heisenberg’s Principle of Indeterminacy or Uncertainty (HPI) and Quantum Gravity (QG):

In this section, it is intended to show that “the roots of the equations of HPI are in QG i.e. in exponentially varying accelerated field (EVAF)”. So that the principle of HPI is no more the

fundamental principle, as it can be derived on the basis of the equations used in EVAF. First we will consider how the roots of the equations of HPI are in QG. The two equations of HPI are (1)  $\Delta p \cdot \Delta x = \hbar/2$  and (2)  $\Delta E \cdot \Delta t = \hbar/2$ . Equating both we get,  $\Delta p \cdot \Delta x = \Delta E \cdot \Delta t$  i.e.  $\Delta E/\Delta p = \Delta x/\Delta t$ . These two ratios represent velocity. In Indeterminacy form for any particle such as electron  $e^-$ , proton  $p^+$ ,  $w^\pm$ , etc. always the velocity *must be* taken as that of the photon i.e. 'C'.  $\therefore \Delta E/\Delta p = \Delta x/\Delta t = C$ .

Now multiplying the equation (1) by 'C' we get  $\Delta p \cdot C \cdot \Delta x = \hbar C/2$  i.e.  $\Delta E \cdot \Delta x = \hbar C/2 = kC\check{C}/2$  as  $\hbar = k\check{C}$ . So  $\Delta E \cdot \Delta x = 10^{-5}$  ev as  $k = 2 \cdot 10^{-5}$  ev/cm/sec<sup>2</sup>. But we see that the RHS of the equation,  $kC\check{C}/2$  (or  $10^{-5}$  ev) is the value that we find in the IT for  $w^\pm$  particles, for quantum gravity energy  $E_Q$  in QG field. In IT, for  $w^\pm$  particles the relation between  $E_Q$  and the interaction range 'r' is  $E_Q \cdot r = \pi\check{G}\beta k/2$ . But for  $w^\pm$  particles  $\pi\check{G}\beta \approx C\check{C}$  where  $\beta$  corresponds to  $w^\pm$  particles.

$\therefore E_Q \cdot r = kC\check{C}/2 = 10^{-5}$  ev. cm. Thus we see that  $E_Q \cdot r = \Delta E \cdot \Delta x$  and also that  $\Delta x = r$  and  $\Delta E = E_Q$ . Not only this, in indeterminacy form  $\Delta x = r = \Delta l = \Delta\lambda/2$  i.e. indeterminacy in the position of the particle is the same as the interaction range 'r' and indeterminacy in the stretching  $\Delta l$  of the particle and also half of the indeterminacy of the wave length  $\Delta\lambda$  of the particle. Where  $\Delta\lambda = kC\check{C} / \Delta E = \hbar C / \Delta E$ . It is interesting to note that the quantum gravity energy 'E<sub>Q</sub>' in the Black Hole chart for Black-Holes (BH) which is related to the gravitational radius 'R' of the BH by the relation  $E_Q \cdot R = \check{G}kC^2/4G = 10^{30}$  ev. cm. is directly equivalent to the indeterminacy equation  $\Delta E \cdot \Delta x = \hbar C/2 = kC\check{C}/2$ , if the gravitational radius 'R' is expressed in terms of 'r' (the interaction range) according to the relation  $r/R = 2\pi\check{G}\beta/C^2 = 10^{-35}$  for  $w^\pm$  particles if ' $\beta$ ' corresponds to  $w^\pm$  particles.  $\therefore E_Q \cdot r = \pi\check{G}\beta k/2$ . But for  $w^\pm$  particles,  $\pi\check{G}\beta \approx C\check{C}$ .  $\therefore E_Q \cdot r = kC\check{C}/2 = 10^{-5}$  ev. cm. Thus we see how the roots of the equations of HPI are in QG.

[Although in reality 'r' and 'l' are different according to the relation  $r \cdot l = \pi \check{G} \beta t^2 / 2$  and also  $l$  and  $\lambda$  are different (in fact opposite) according to the relation  $l \cdot \lambda = t^2 C \check{C}$ . But 'r' and 'λ' are related to each other by the relation  $r = \lambda / 2$  for  $w^\pm$  particles, according to the relations  $r \cdot l = \pi \check{G} \beta t^2 / 2$  and  $l \cdot \lambda = t^2 C \check{C}$  as  $\pi \check{G} \beta \approx C \check{C}$  for  $w^\pm$  particles. In 'Non indeterminacy' form stretching of the particle,  $l$ , is the same as the position of the particle 'x' i.e.  $l = x$ . Finding the position of the particle 'x', in the micro world is not the same as finding where it is but it is rather what is "*The length of space*" occupied by it i.e.  $l$ . Similarly the relationship between the momentum 'p' and position 'x' (or stretching,  $l$ ) in 'non-indeterminacy' form is according to the relations  $p^2 = 2mE$ ;  $E = f_i \cdot l$  and  $f_i = m \cdot a_0$  is  $p = m (2a_0 l)^{1/2} = 2.6 \cdot 10^{11} m(l)^{1/2}$  as  $(2a_0)^{1/2} = 2.6 \cdot 10^{11} (\text{cm/sec}^2)^{1/2}$ . But in "indeterminacy form", the relationship between 'p' and  $l$  (i.e. x) becomes  $\Delta p \cdot \Delta x = \hbar / 2$ ].

Now before deriving the relations of the HPI we will consider the impact of indeterminacy on certain concepts which we have employed in EVAF like Inertial force of the particle  $f_i$ , time  $t$  etc. In EVAF,  $l \cdot \lambda = t^2 C \check{C}$ . In indeterminacy form this equation becomes  $\Delta l \cdot 2\Delta l = \Delta t^2 C \check{C}$  as  $\Delta \lambda = 2\Delta l$ . Since  $\Delta l = \Delta x$ , we can also write  $2\Delta x^2 = \Delta t^2 C \check{C}$ . This equation shows how the value of  $\Delta t^2$  changes as  $\Delta x$  changes. Since  $t^2$  like 'f<sub>i</sub>' is invariant for a particle of particular mass and remains so as long as the mass of the particle remains invariant. The fact that  $\Delta t^2$  varies as  $\Delta x$  varies indicates that the mass of the particle also changes as  $\Delta x$  varies in indeterminacy measurements. That is, the mass of the particle is distorted and let us use the symbol  $\delta m$  for this distorted mass of the particle. We can derive the relationship between  $\delta m$  and  $\Delta x$  as follows. Since the mass  $m$  of the particle and its value of  $t^2$  are related by the equation  $m \cdot t^2 = k/a_0 = 10^{-39} \text{ gm sec}^2$ . In indeterminacy form this relation becomes  $\delta m \cdot \Delta t^2 = k/a_0 = 10^{-39} \text{ gm.cm}^2$ . Since,  $\Delta t^2 = 2\Delta x^2 / C \check{C}$  substituting we get,  $\delta m \cdot 2\Delta x^2 = (k/a_0) C \check{C} = 10^{-39} \text{ gm.sec}^2$ . Therefore,  $\delta m \cdot \Delta x^2 = k C \check{C} / 2a_0 = 5 \cdot 10^{-40} \text{ gm.cm}^2$ . The value of 'f<sub>i</sub>' varies as  $\Delta x$  varies according to the relation  $\Delta t^2 \Delta f_i = k$ .



Since  $\Delta t^2 = 2\Delta x^2 / C\check{C}$ ,  $\Delta f_i * 2\Delta x^2 = k C\check{C}$ .  $\therefore \Delta f_i = kC\check{C}/2\Delta x^2$ . If 'k' is expressed in terms of ev i.e.  $k = 2*10^{-5}$  ev/cm/sec<sup>2</sup>.  $\Delta f_i$  becomes,  $\Delta f_i = 10^{-5} / \Delta x^2$  ev/cm. It is to be noted that the relation between the mass of photon,  $\Delta m$ , corresponding to  $\Delta E$  (or  $E_Q$  in IT) is  $\Delta m C^2 = \Delta E = k C\check{C}/\Delta \lambda = kC\check{C}/2\Delta x$ .  $\therefore \Delta m = k\check{C}/(2C \cdot \Delta x)$ .  $\therefore \Delta m \Delta x = k\check{C}/2C = 1.8 * 10^{-38}$  gm. cm. Hence  $\Delta m$  is related to  $\delta m$  by the equation  $\Delta m/\delta m = 36 \Delta x$ .

### 8.1. Derivations of the equations of HPI from the relations of EVAF

We know that  $x \lambda = t^2 C\check{C}$  ('t' is replaced by 'x'). In indeterminacy form this equation is  $\Delta x \Delta \lambda = \Delta t^2 C\check{C}$ . Now multiplying by ' $\Delta f_i$ ' we get,  $\Delta f_i \Delta x \Delta \lambda = \Delta t^2 \Delta f_i C\check{C}$ . But  $\Delta f_i \Delta x / C = \Delta E/C = \Delta P$  and  $\Delta t^2 \Delta f_i = k$ .  $\therefore \Delta P \Delta \lambda = k \check{C}$ . But  $\Delta \lambda = 2\Delta x$  and  $k \check{C} = \hbar$ .  $\therefore \Delta P \Delta x = \hbar/2$ . Thus one relation of HPI is derived. Similarly, the other equation of HPI,  $\Delta E \Delta t = \hbar/2$  is derived as follows since  $\Delta f_i \Delta x \Delta \lambda = \Delta t^2 \Delta f_i C\check{C}$ . But  $\Delta f_i \Delta x = \Delta E$  and  $\Delta t^2 \Delta f_i = k$ .  $\therefore \Delta E \Delta \lambda = kC\check{C} = \hbar C$ . But  $\Delta \lambda = 2 \Delta x$ ,  $\therefore \Delta E \Delta x = \hbar C/2$ . We know that  $\Delta x/C = \Delta t$  (or  $\Delta x/\Delta t = C$ ),  $\therefore \Delta E \Delta t = \hbar/2$ .

We can also derive the equations of HPI even from  $t^2 = 1/v\ddot{v}$  and  $\lambda = C\check{C}$  as follows.

In indeterminacy form  $t^2 = 1/v\ddot{v}$  is written as  $\Delta t^2 = 1/\Delta v \Delta \ddot{v}$ . Multiplying this equation by  $\Delta f_i$  and  $\check{C}$  we get  $\Delta t^2 \Delta f_i \check{C} = \Delta f_i \check{C} / \Delta v \Delta \ddot{v}$ . But  $\Delta f_i \Delta t^2 = k$  and  $k \check{C} = \hbar$ .  $\therefore \Delta f_i \check{C} / \Delta v \Delta \ddot{v} = \hbar$ . We know that,  $\check{t} = \check{C}/\ddot{v}$  and  $\Delta \check{t} = \check{C}/\Delta \ddot{v}$ . Substituting we get  $\Delta f_i \Delta \check{t} / \Delta v = \hbar$ . But  $\Delta f_i \Delta \check{t} = \Delta E$ .  $\therefore \Delta E / \Delta v = \hbar$  and  $\Delta v = C/\Delta \lambda = C/2\Delta x = \frac{1}{2} \Delta t$  as  $\Delta x/C = \Delta t$ .  $\therefore \Delta E 2\Delta t = \hbar$  i.e.  $\Delta E \Delta t = \hbar/2$ .

$\Delta f_i$  is also equal to the ratios of  $\Delta E$  and  $\Delta x$ ; and  $\Delta P$  and  $\Delta t$  i.e.  $\Delta E / \Delta x = \Delta P / \Delta t = \Delta f_i$ .

We get the other equation of HPI  $\Delta P \Delta x = \hbar/2$  as follows. Since  $\Delta v = 1/2\Delta t$ , substituting in  $\Delta f$ ,  $\check{C}/\Delta v \Delta \check{v} = \hbar$ , we get  $\Delta f \cdot 2\Delta t \check{C}/\Delta \check{v} = \hbar$ . But  $\Delta f \cdot 2\Delta t = 2\Delta P$  and  $\check{C}/\Delta \check{v} = \Delta l = \Delta x \therefore \Delta P \Delta x = \hbar/2$ .

Let us derive the equations of HPI from  $a \lambda = C\check{C}$ . In indeterminacy form it becomes  $\Delta a \Delta \lambda = C\check{C}$ . Multiplying by 'k' we get  $k \Delta a \Delta \lambda = k C\check{C}$ . Since  $\Delta E = k \Delta a$  and  $\Delta \lambda = 2\Delta x$  and  $k \check{C} = \hbar$  we get,  $\Delta E 2\Delta x = \hbar C$ . But  $\Delta x/C = \Delta t \therefore \Delta E \Delta t = \hbar/2$ . Since  $\Delta E 2\Delta x = \hbar C$  and  $\Delta E/C = \Delta P$ , we get  $\Delta P \Delta x = \hbar/2$ .

### 8.2. Measurement of Indeterminacy values of $\Delta P$ , $\Delta x$ , $\Delta E$ and $\Delta t$ :

*Measurement of  $\Delta P$* : - From Quantum Mechanics,  $\Delta P/P = x/d$ , where 'P' is the momentum of the particle in the absence of indeterminacy, 'x' is the arc length of beam of particle like electron, proton, etc., on the screen on which the particle is encountered, 'd' is the distance of the screen. But we know that  $P = m(2a^0 \cdot x)^{1/2} = 2.6 * 10^{11} m \sqrt{x}$  as  $\sqrt{(2a^0)} = 2.6 * 10^{11} (\text{cm/sec}^2)^{1/2}$ ,  $l$  is replaced by 'x'.  $\therefore \Delta P = 2.6 * 10^{11} m x \sqrt{x}/d$ , where 'm' is the mass of the particle.

*Measurement of  $\Delta x$* : Since,  $\Delta P \Delta x = \hbar/2$ ;  $\Delta x = \hbar/2\Delta P = \hbar/5.2 * 10^{11} \cdot d/mx\sqrt{x}$  i.e.  $\Delta x = 1.9 * 10^{-39}$

$d/m x \sqrt{x}$ . *Measurement of  $\Delta E$* : Since  $\Delta E = \Delta P C = 2.6 * 10^{11} (m x \sqrt{x}/d) C = 7.8 * 10^{21} m x \sqrt{x}/$

$d = \Delta E$  *Measurement of  $\Delta t$* : Similarly,  $\Delta t = \hbar/2\Delta E = \hbar/1.6 * 10^{22} d/ m x \sqrt{x} = 7 * 10^{-50} d/ m x \sqrt{x}$

## 9. Conclusion

After going through the article, it becomes obvious that one has to overcome the *Inertia* of accepting new laws and concepts, for without them it would be impossible to develop a complete theory of QG. It is the Quantum Gravity theory (in the form of EVAF), which serves as common platform for combining gravitation with Electromagnetism. Based on the second law of QG, EM field is also brought with in the scope of EVAF. QG field exhibited by Black Hole is identified with the logarithmic spiral path. The path followed by micro particles in EVAF is conical spiral path, whose projection gives LS path; where as test-masses describe the LS path. Thus the geometry of QG field is the geometry of LS path. Application of spinors to it gives the *Immirzi-parameter*. The application of tensors to it gives the constant value of  $60^\circ$  of coiling or uncoiling for all BH and Quasars, which ‘evolve’ into ‘spiral galaxies’. The unification of all the four physical interactions is explained on the basis of the IT. IT also gives the decay times of various elementary particles irrespective of their nature. At the same time solving the problem of high- energy existence in the universe in Black Holes, Quasars, etc. Thus the formulation of QG theory solves such problems as Dark Matter and Dark energy existence; Energy released during supernova explosion, etc. It also gives *new* views on Cosmology. The atomic energy emission is explained on the basis of exponential law. The principle of indeterminacy is shown to be no more one of the fundamental principles of physics.

### **References.**

[1] Savelyev I V 1981 *Physics-A General Course* vol 3(Moscow: MIR publishers) p36.

Graphics.zip

**GRAPHICS:**

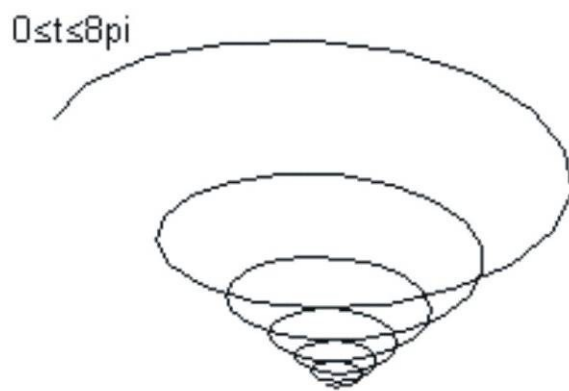
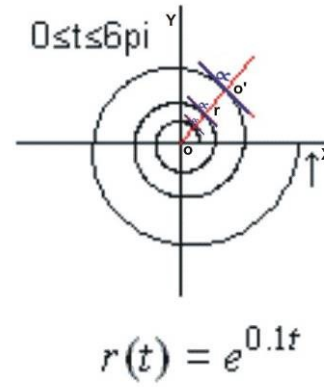
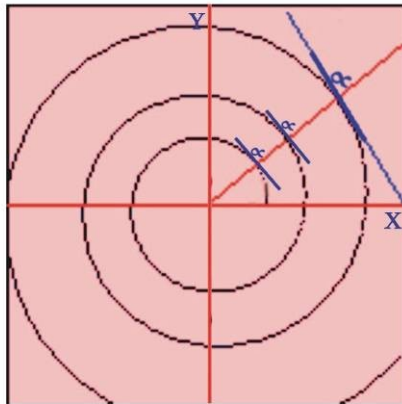

$$x = 0.5 \exp(0.15t) \cos(2t)$$

$$y = 0.5 \exp(0.15t) \sin(2t)$$

$$z = 0.5 \exp(0.15t)$$

$$x = \exp(\theta \cdot \cot(80^\circ)) \cdot \cos(\theta), \quad y = \exp(\theta \cdot \cot(80^\circ)) \cdot \sin(\theta)$$

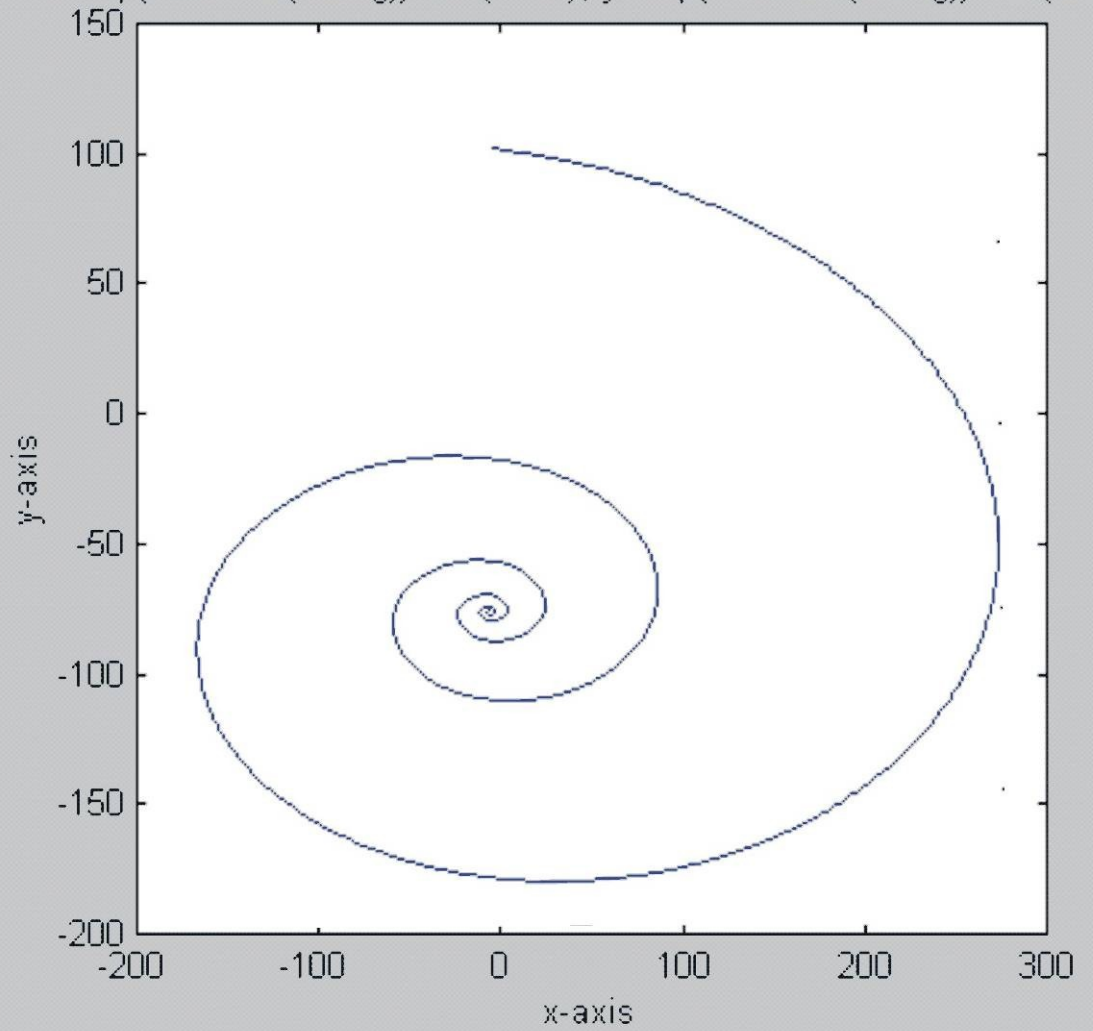

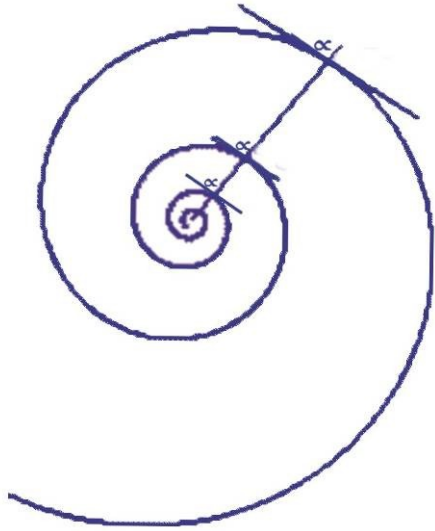

### Equiangular Spiral

