



**TGD AND  
FRINGE PHYSICS**

**Ph.D Matti Pitkänen**

# TGD AND FRINGE PHYSICS

Matti Pitkänen

*Köydenpunojankatu D 11, 10900, Hanko, Finland*



## Preface

This book belongs to a series of online books summarizing the recent state Topological Geometro-dynamics (TGD) and its applications. TGD can be regarded as a unified theory of fundamental interactions but is not the kind of unified theory as so called GUTs constructed by graduate students at seventies and eighties using detailed recipes for how to reduce everything to group theory. Nowadays this activity has been completely computerized and it probably takes only a few hours to print out the predictions of this kind of unified theory as an article in the desired format. TGD is something different and I am not ashamed to confess that I have devoted the last 37 years of my life to this enterprise and am still unable to write The Rules.

If I remember correctly, I got the basic idea of Topological Geometro-dynamics (TGD) during autumn 1977, perhaps it was October. What I realized was that the representability of physical space-times as 4-dimensional surfaces of some higher-dimensional space-time obtained by replacing the points of Minkowski space with some very small compact internal space could resolve the conceptual difficulties of general relativity related to the definition of the notion of energy. This belief was too optimistic and only with the advent of what I call zero energy ontology the understanding of the notion of Poincare invariance has become satisfactory. This required also the understanding of the relationship to General Relativity.

It soon became clear that the approach leads to a generalization of the notion of space-time with particles being represented by space-time surfaces with finite size so that TGD could be also seen as a generalization of the string model. Much later it became clear that this generalization is consistent with conformal invariance only if space-time is 4-dimensional and the Minkowski space factor of imbedding space is 4-dimensional. During last year it became clear that 4-D Minkowski space and 4-D complex projective space  $CP_2$  are completely unique in the sense that they allow twistor space with Kähler structure.

It took some time to discover that also the geometrization of also gauge interactions and elementary particle quantum numbers could be possible in this framework: it took two years to find the unique internal space ( $CP_2$ ) providing this geometrization involving also the realization that family replication phenomenon for fermions has a natural topological explanation in TGD framework and that the symmetries of the standard model symmetries are much more profound than pragmatic TOE builders have believed them to be. If TGD is correct, main stream particle physics chose the wrong track leading to the recent deep crisis when people decided that quarks and leptons belong to same multiplet of the gauge group implying instability of proton.

There have been also longstanding problems.

- Gravitational energy is well-defined in cosmological models but is not conserved. Hence the conservation of the inertial energy does not seem to be consistent with the Equivalence Principle. Furthermore, the imbeddings of Robertson-Walker cosmologies turned out to be vacuum extremals with respect to the inertial energy. About 25 years was needed to realize that the sign of the inertial energy can be also negative and in cosmological scales the density of inertial energy vanishes: physically acceptable universes are creatable from vacuum. Eventually this led to the notion of zero energy ontology (ZEO) which deviates dramatically from the standard ontology being however consistent with the crossing symmetry of quantum field theories. In this framework the quantum numbers are assigned with zero energy states located at the boundaries of so called causal diamonds defined as intersections of future and past directed light-cones. The notion of energy-momentum becomes length scale dependent since one has a scale hierarchy for causal diamonds. This allows to understand the non-conservation of energy as apparent.

Equivalence Principle as it is expressed by Einstein's equations follows from Poincare invariance once it is realized that GRT space-time is obtained from the many-sheeted space-time of TGD by lumping together the space-time sheets to a region of Minkowski space and endowing it with an effective metric given as a sum of Minkowski metric and deviations of the metrics of space-time sheets from Minkowski metric. Similar description relates classical gauge potentials identified as components of induced spinor connection to Yang-Mills gauge potentials in GRT space-time. Various topological inhomogenities below resolution scale identified as particles are described using energy momentum tensor and gauge currents.

- From the beginning it was clear that the theory predicts the presence of long ranged classical electro-weak and color gauge fields and that these fields necessarily accompany classical electromagnetic fields.

It took about 26 years to gain the maturity to admit the obvious: these fields are classical correlates for long range color and weak interactions assignable to dark matter. The only possible conclusion is that TGD physics is a fractal consisting of an entire hierarchy of fractal copies of standard model physics. Also the understanding of electro-weak massivation and screening of weak charges has been a long standing problem, and 32 years was needed to discover that what I call weak form of electric-magnetic duality gives a satisfactory solution of the problem and provides also surprisingly powerful insights to the mathematical structure of quantum TGD.

The latest development was the realization that the well- definedness of electromagnetic charge as quantum number for the modes of the induced spinors field requires that the  $CP_2$  projection of the region in which they are non-vanishing carries vanishing  $W$  boson field and is 2-D. This implies in the generic case their localization to 2-D surfaces: string world sheets and possibly also partonic 2-surfaces. This localization applies to all modes except covariantly constant right handed neutrino generating supersymmetry and implies that string model in 4-D space-time is part of TGD. Localization is possible only for Kähler-Dirac assigned with Kähler action defining the dynamics of space-time surfaces. One must however leave open the question whether  $W$  field might vanish for the space-time of GRT if related to many-sheeted space-time in the proposed manner even when they do not vanish for space-time sheets.

I started the serious attempts to construct quantum TGD after my thesis around 1982. The original optimistic hope was that path integral formalism or canonical quantization might be enough to construct the quantum theory but the first discovery made already during first year of TGD was that these formalisms might be useless due to the extreme non-linearity and enormous vacuum degeneracy of the theory. This turned out to be the case.

- It took some years to discover that the only working approach is based on the generalization of Einstein's program. Quantum physics involves the geometrization of the infinite-dimensional "world of classical worlds" (WCW) identified as 3-dimensional surfaces. Still few years had to pass before I understood that general coordinate invariance leads to a more or less unique solution of the problem and in positive energy ontology implies that space-time surfaces are analogous to Bohr orbits. This in positive energy ontology in which space-like 3-surface is basic object. It is not clear whether Bohr orbitology is necessary also in ZEO in which space-time surfaces connect space-like 3-surfaces at the light-like boundaries of causal diamond CD obtained as intersection of future and past directed light-cones (with  $CP_2$  factor included). The reason is that the pair of 3-surfaces replaces the boundary conditions at single 3-surface involving also time derivatives. If one assumes Bohr orbitology then strong correlations between the 3-surfaces at the ends of CD follow. Still a couple of years and I discovered that quantum states of the Universe can be identified as classical spinor fields in WCW. Only quantum jump remains the genuinely quantal aspect of quantum physics.
- During these years TGD led to a rather profound generalization of the space-time concept. Quite general properties of the theory led to the notion of many-sheeted space-time with sheets representing physical subsystems of various sizes. At the beginning of 90s I became dimly aware of the importance of p-adic number fields and soon ended up with the idea that p-adic thermodynamics for a conformally invariant system allows to understand elementary particle massivation with amazingly few input assumptions. The attempts to understand p-adicity from basic principles led gradually to the vision about physics as a generalized number theory as an approach complementary to the physics as an infinite-dimensional spinor geometry of WCW approach. One of its elements was a generalization of the number concept obtained by fusing real numbers and various p-adic numbers along common rationals. The number theoretical trinity involves besides p-adic number fields also quaternions and octonions and the notion of infinite prime.
- TGD inspired theory of consciousness entered the scheme after 1995 as I started to write a book about consciousness. Gradually it became difficult to say where physics ends and

consciousness theory begins since consciousness theory could be seen as a generalization of quantum measurement theory by identifying quantum jump as a moment of consciousness and by replacing the observer with the notion of self identified as a system which is conscious as long as it can avoid entanglement with environment. The somewhat cryptic statement "Everything is conscious and consciousness can be only lost" summarizes the basic philosophy neatly.

The idea about p-adic physics as physics of cognition and intentionality emerged also rather naturally and implies perhaps the most dramatic generalization of the space-time concept in which most points of p-adic space-time sheets are infinite in real sense and the projection to the real imbedding space consists of discrete set of points. One of the most fascinating outcomes was the observation that the entropy based on p-adic norm can be negative. This observation led to the vision that life can be regarded as something in the intersection of real and p-adic worlds. Negentropic entanglement has interpretation as a correlate for various positively colored aspects of conscious experience and means also the possibility of strongly correlated states stable under state function reduction and different from the conventional bound states and perhaps playing key role in the energy metabolism of living matter.

If one requires consistency of Negentropy Maximization Principle with standard measurement theory, negentropic entanglement defined in terms of number theoretic negentropy is necessarily associated with a density matrix proportional to unit matrix and is maximal and is characterized by the dimension  $n$  of the unit matrix. Negentropy is positive and maximal for a p-adic unique prime dividing  $n$ .

- One of the latest threads in the evolution of ideas is not more than nine years old. Learning about the paper of Laurent Nottale about the possibility to identify planetary orbits as Bohr orbits with a gigantic value of gravitational Planck constant made once again possible to see the obvious. Dynamical quantized Planck constant is strongly suggested by quantum classical correspondence and the fact that space-time sheets identifiable as quantum coherence regions can have arbitrarily large sizes. Second motivation for the hierarchy of Planck constants comes from bio-electromagnetism suggesting that in living systems Planck constant could have large values making macroscopic quantum coherence possible. The interpretation of dark matter as a hierarchy of phases of ordinary matter characterized by the value of Planck constant is very natural.

During summer 2010 several new insights about the mathematical structure and interpretation of TGD emerged. One of these insights was the realization that the postulated hierarchy of Planck constants might follow from the basic structure of quantum TGD. The point is that due to the extreme non-linearity of the classical action principle the correspondence between canonical momentum densities and time derivatives of the imbedding space coordinates is one-to-many and the natural description of the situation is in terms of local singular covering spaces of the imbedding space. One could speak about effective value of Planck constant  $h_{eff} = n \times h$  coming as a multiple of minimal value of Planck constant. Quite recently it became clear that the non-determinism of Kähler action is indeed the fundamental justification for the hierarchy: the integer  $n$  can be also interpreted as the integer characterizing the dimension of unit matrix characterizing negentropic entanglement made possible by the many-sheeted character of the space-time surface.

Due to conformal invariance acting as gauge symmetry the  $n$  degenerate space-time sheets must be replaced with conformal equivalence classes of space-time sheets and conformal transformations correspond to quantum critical deformations leaving the ends of space-time surfaces invariant. Conformal invariance would be broken: only the sub-algebra for which conformal weights are divisible by  $n$  act as gauge symmetries. Thus deep connections between conformal invariance related to quantum criticality, hierarchy of Planck constants, negentropic entanglement, effective p-adic topology, and non-determinism of Kähler action perhaps reflecting p-adic non-determinism emerges.

The implications of the hierarchy of Planck constants are extremely far reaching so that the significance of the reduction of this hierarchy to the basic mathematical structure distinguishing between TGD and competing theories cannot be under-estimated.

From the point of view of particle physics the ultimate goal is of course a practical construction recipe for the S-matrix of the theory. I have myself regarded this dream as quite too ambitious taking into account how far reaching re-structuring and generalization of the basic mathematical structure of quantum physics is required. It has indeed turned out that the dream about explicit formula is unrealistic before one has understood what happens in quantum jump. Symmetries and general physical principles have turned out to be the proper guide line here. To give some impressions about what is required some highlights are in order.

- With the emergence of ZEO the notion of S-matrix was replaced with M-matrix defined between positive and negative energy parts of zero energy states. M-matrix can be interpreted as a complex square root of density matrix representable as a diagonal and positive square root of density matrix and unitary S-matrix so that quantum theory in ZEO can be said to define a square root of thermodynamics at least formally. M-matrices in turn combine to form the rows of unitary U-matrix defined between zero energy states.
- A decisive step was the strengthening of the General Coordinate Invariance to the requirement that the formulations of the theory in terms of light-like 3-surfaces identified as 3-surfaces at which the induced metric of space-time surfaces changes its signature and in terms of space-like 3-surfaces are equivalent. This means effective 2-dimensionality in the sense that partonic 2-surfaces defined as intersections of these two kinds of surfaces plus 4-D tangent space data at partonic 2-surfaces code for the physics. Quantum classical correspondence requires the coding of the quantum numbers characterizing quantum states assigned to the partonic 2-surfaces to the geometry of space-time surface. This is achieved by adding to the modified Dirac action a measurement interaction term assigned with light-like 3-surfaces.
- The replacement of strings with light-like 3-surfaces equivalent to space-like 3-surfaces means enormous generalization of the super conformal symmetries of string models. A further generalization of these symmetries to non-local Yangian symmetries generalizing the recently discovered Yangian symmetry of  $\mathcal{N} = 4$  supersymmetric Yang-Mills theories is highly suggestive. Here the replacement of point like particles with partonic 2-surfaces means the replacement of conformal symmetry of Minkowski space with infinite-dimensional super-conformal algebras. Yangian symmetry provides also a further refinement to the notion of conserved quantum numbers allowing to define them for bound states using non-local energy conserved currents.
- A further attractive idea is that quantum TGD reduces to almost topological quantum field theory. This is possible if the Kähler action for the preferred extremals defining WCW Kähler function reduces to a 3-D boundary term. This takes place if the conserved currents are so called Beltrami fields with the defining property that the coordinates associated with flow lines extend to single global coordinate variable. This ansatz together with the weak form of electric-magnetic duality reduces the Kähler action to Chern-Simons term with the condition that the 3-surfaces are extremals of Chern-Simons action subject to the constraint force defined by the weak form of electric magnetic duality. It is the latter constraint which prevents the trivialization of the theory to a topological quantum field theory. Also the identification of the Kähler function of WCW as Dirac determinant finds support as well as the description of the scattering amplitudes in terms of braids with interpretation in terms of finite measurement resolution coded to the basic structure of the solutions of field equations.
- In standard QFT Feynman diagrams provide the description of scattering amplitudes. The beauty of Feynman diagrams is that they realize unitarity automatically via the so called Cutkosky rules. In contrast to Feynman's original beliefs, Feynman diagrams and virtual particles are taken only as a convenient mathematical tool in quantum field theories. QFT approach is however plagued by UV and IR divergences and one must keep mind open for the possibility that a genuine progress might mean opening of the black box of the virtual particle.

In TGD framework this generalization of Feynman diagrams indeed emerges unavoidably. Light-like 3-surfaces replace the lines of Feynman diagrams and vertices are replaced by 2-D partonic 2-surfaces. Zero energy ontology and the interpretation of parton orbits as light-like

”wormhole throats” suggests that virtual particles do not differ from on mass shell particles only in that the four- and three- momenta of wormhole throats fail to be parallel. The two throats of the wormhole contact defining virtual particle would contact carry on mass shell quantum numbers but for virtual particles the four-momenta need not be parallel and can also have opposite signs of energy.

The localization of the nodes of induced spinor fields to 2-D string world sheets (and possibly also to partonic 2-surfaces) implies a stringy formulation of the theory analogous to stringy variant of twistor formalism with string world sheets having interpretation as 2-braids. In TGD framework fermionic variant of twistor Grassmann formalism leads to a stringy variant of twistor diagrammatics in which basic fermions can be said to be on mass-shell but carry non-physical helicities in the internal lines. This suggests the generalization of the Yangian symmetry to infinite-dimensional super-conformal algebras.

What I have said above is strongly biased view about the recent situation in quantum TGD. This vision is single man’s view and doomed to contain unrealistic elements as I know from experience. My dream is that young critical readers could take this vision seriously enough to try to demonstrate that some of its basic premises are wrong or to develop an alternative based on these or better premises. I must be however honest and tell that 32 years of TGD is a really vast bundle of thoughts and quite a challenge for anyone who is not able to cheat himself by taking the attitude of a blind believer or a light-hearted debunker trusting on the power of easy rhetoric tricks.

Matti Pitkänen

Hanko,

September 16, 2014

## Acknowledgements

Neither TGD nor these books would exist without the help and encouragement of many people. The friendship with Heikki and Raija Haila and their family have kept me in contact with the everyday world and without this friendship I would not have survived through these lonely 32 years most of which I have remained unemployed as a scientific dissident. I am happy that my children have understood my difficult position and like my friends have believed that what I am doing is something valuable although I have not received any official recognition for it.

During last decade Tapio Tammi has helped me quite concretely by providing the necessary computer facilities and being one of the few persons in Finland with whom to discuss about my work. I have had also stimulating discussions with Samuli Penttinen who has also helped to get through the economical situations in which there seemed to be no hope. The continual updating of fifteen online books means quite a heavy bureaucracy at the level of bits and without a systemization one ends up with endless copying and pasting and internal consistency is soon lost. Pekka Rapinoja has offered his help in this respect and I am especially grateful for him for my Python skills. Also Matti Vallinkoski has helped me in computer related problems.

The collaboration with Lian Sidorov was extremely fruitful and she also helped me to survive economically through the hardest years. The participation to CASYS conferences in Liege has been an important window to the academic world and I am grateful for Daniel Dubois and Peter Marcer for making this participation possible. The discussions and collaboration with Eduardo de Luna and Istvan Dienes stimulated the hope that the communication of new vision might not be a mission impossible after all. Also blog discussions have been very useful. During these years I have received innumerable email contacts from people around the world. In particular, I am grateful for Mark McWilliams and Ulla Matfolk for providing links to possibly interesting web sites and articles. These contacts have helped me to avoid the depressive feeling of being some kind of Don Quixote of Science and helped me to widen my views: I am grateful for all these people.

In the situation in which the conventional scientific communication channels are strictly closed it is important to have some loop hole through which the information about the work done can at least in principle leak to the publicity through the iron wall of the academic censorship. Without any exaggeration I can say that without the world wide web I would not have survived as a scientist nor as individual. Homepage and blog are however not enough since only the formally published



result is a result in recent day science. Publishing is however impossible without a direct support from power holders- even in archives like arXiv.org.

Situation changed for five years ago as Andrew Adamatsky proposed the writing of a book about TGD when I had already got used to the thought that my work would not be published during my life time. The Prespacetime Journal and two other journals related to quantum biology and consciousness - all of them founded by Huping Hu - have provided this kind of loop holes. In particular, Dainis Zeps, Phil Gibbs, and Arkadiusz Jadczyk deserve my gratitude for their kind help in the preparation of an article series about TGD catalyzing a considerable progress in the understanding of quantum TGD. Also the viXra archive founded by Phil Gibbs and its predecessor Archive Freedom have been of great help: Victor Christianto deserves special thanks for doing the hard work needed to run Archive Freedom. Also the Neuroquantology Journal founded by Sultan Tarlaci deserves a special mention for its publication policy. And last but not least: there are people who experience as a fascinating intellectual challenge to spoil the practical working conditions of a person working with something which might be called unified theory: I am grateful for the people who have helped me to survive through the virus attacks, an activity which has taken roughly one month per year during the last half decade and given a strong hue of grey to my hair.

For a person approaching his sixty year birthday it is somewhat easier to overcome the hard feelings due to the loss of academic human rights than for an inpatient youngster. Unfortunately the economic situation has become increasingly difficult during the twenty years after the economic depression in Finland which in practice meant that Finland ceased to be a constitutional state in the strong sense of the word. It became possible to depose people like me from the society without fear about public reactions and the classification as dropout became a convenient tool of ridicule to circumvent the ethical issues. During last few years when the right wing has held the political power this trend has been steadily strengthening. In this kind of situation the concrete help from individuals has been and will be of utmost importance. Against this background it becomes obvious that this kind of work is not possible without the support from outside and I apologize for not being able to mention all the people who have helped me during these years.

Matti Pitkänen

Hanko,  
September 15, 2010

# Contents

<b>1</b>	<b>Introduction</b>	<b>1</b>
1.1	Basic Ideas of Topological Geometroynamics (TGD)	1
1.1.1	Basic vision very briefly	1
1.1.2	Two manners to see TGD and their fusion	2
1.1.3	Basic objections	4
1.1.4	p-Adic variants of space-time surfaces	5
1.1.5	The threads in the development of quantum TGD	5
1.1.6	Hierarchy of Planck constants and dark matter hierarchy	11
1.2	Bird's eye of view about the topics of the book	13
1.3	Sources	14
1.4	The contents of the book	14
1.4.1	Anomalies related to the classical $Z^0$ force and gravitation	14
1.4.2	The notion of free energy and many-sheeted space-time	16
1.4.3	About strange effects related to rotating magnetic systems	17
1.4.4	Did Tesla discover the mechanism changing the arrow of time?	19
1.4.5	About Concrete Realization of Remote Metabolism	19
1.4.6	Summary of TGD Inspired Ideas about Free Energy	20
1.4.7	Ufos, aliens, and the new physics	20
<b>2</b>	<b>Anomalies Related to the Classical <math>Z^0</math> Force and Gravitation</b>	<b>23</b>
2.1	Introduction	23
2.1.1	TGD based view about dark matter	23
2.1.2	New Physics effects related to the new space-time concept	24
2.1.3	Some gravitational anomalies	25
2.1.4	Anomalies related to $Z^0$ force in astrophysical length scales	25
2.1.5	Anomalies related to rotating systems	25
2.2	The new view about inertial and gravitational energy	26
2.2.1	Two manners to circumvent the infinite vacuum energy	26
2.2.2	Zero energy vacuum is matter-antimatter asymmetric	27
2.2.3	Creation of matter from vacuum by annihilation of laser waves and their phase conjugates?	27
2.2.4	Re-interpretation of TGD inspired cosmology	27
2.3	Some gravitational anomalies	29
2.3.1	Anomalous time dilation effects due to warping as basic distinction between TGD and GRT	29
2.3.2	Anomalies related to spinning astrophysical objects	32
2.4	Is electro-gravity possible in TGD framework?	33
2.4.1	Classical gravitational fields for space-time surfaces for which $CP_2$ projection corresponds to a homologically non-trivial geodesic sphere	34
2.4.2	TGD does not predict anomalously large coupling of gravitation to classical gauge fields	36
2.4.3	Gravito-Maxwell field associated with a dipole field	36
2.5	Allais effect and TGD	38
2.5.1	Introduction	38
2.5.2	Could gravitational screening explain Allais effect	39

2.5.3	Allais effect as evidence for large values of gravitational Planck constant? . . . . .	44
2.5.4	Could $Z^0$ force be present? . . . . .	49
2.6	Dark $Z^0$ force in astrophysical length scales . . . . .	50
2.6.1	The regularities in radio active decay rates linked to astrophysical cycles . . . . .	50
2.6.2	Torsion fields or $Z^0$ fields . . . . .	53
2.7	How to test the presence of the $Z^0$ force in micrometer-millimeter length scale range? . . . . .	54
2.7.1	Scaling law for dark $Z^0$ charges . . . . .	55
2.7.2	How to directly test the presence of classical $Z^0$ force? . . . . .	56
2.8	Appendix: Allais effect as manifestation of classical $Z^0$ force? . . . . .	61
2.8.1	Screening of dark $Z^0$ MEs emitted by Sun as an explanation of Allais effect? . . . . .	61
2.8.2	Quantitative picture . . . . .	62
<b>3</b>	<b>The Notion of Free Energy and Many-Sheeted Space-Time Concept</b>	<b>65</b>
3.1	Introduction . . . . .	65
3.1.1	Basic new elements of TGD ontology . . . . .	65
3.1.2	Could living systems teach us something about energy technology? . . . . .	66
3.1.3	Various anomalies as support for the picture . . . . .	67
3.1.4	Free energy anomalies . . . . .	67
3.2	Basic ontology of TGD . . . . .	68
3.2.1	T(opological) G(eometro)D(ynamics) very briefly . . . . .	68
3.2.2	Many-sheeted space-time and the notion of field body . . . . .	69
3.2.3	The hierarchy of Planck constants and of dark matter . . . . .	70
3.2.4	Zero energy ontology . . . . .	73
3.3	Many-sheeted space-time, universal metabolic quanta, and plasmoids as primitive life forms . . . . .	76
3.3.1	Evidence for many-sheeted space-time . . . . .	76
3.3.2	Laboratory evidence for plasmoids as life forms . . . . .	79
3.3.3	Universal metabolic quanta . . . . .	81
3.3.4	Life as a symbiosis of plasmoids and biological life . . . . .	83
3.4	Podkletnov effect and Modanese-Podkletnov effect . . . . .	86
3.4.1	Modanese-Podkletnov effect . . . . .	86
3.4.2	Scalar waves of Tesla in TGD framework . . . . .	88
3.4.3	Podkletnov effect . . . . .	89
3.4.4	Biefeld-Brown effect, lifters, corona wind, and Modanese-Podkletnov effect . . . . .	91
3.5	New hydrogen technologies and new physics . . . . .	95
3.5.1	Anomalies related to the dissociation of water and hydrogen molecules . . . . .	95
3.5.2	The anomalies associated with the dissociation of water molecules . . . . .	96
3.5.3	The anomaly related to the thermal dissociation of molecular hydrogen . . . . .	100
3.5.4	Could q-Laguerre equation relate to the claimed fractionation of the principal quantum number for hydrogen atom? . . . . .	101
3.5.5	Free energy from atomic hydrogen . . . . .	106
3.6	Appendix: A generalization of the notion of imbedding space inspired by hierarchy of Planck constants . . . . .	107
3.6.1	The original view about generalized imbedding space . . . . .	107
3.6.2	Fractionization of quantum numbers is not possible if only factor spaces are allowed . . . . .	107
3.6.3	Both covering spaces and factor spaces are possible . . . . .	107
3.6.4	Do factor spaces and coverings correspond to the two kinds of Jones inclusions? . . . . .	108
3.6.5	Fractional Quantum Hall effect . . . . .	109
<b>4</b>	<b>About Strange Effects Related to Rotating Magnetic Systems</b>	<b>111</b>
4.1	Introduction . . . . .	111
4.1.1	Anomalies associated with rotating magnetic systems . . . . .	112
4.1.2	Possible other similar systems . . . . .	114
4.2	Summary about the New Physics effects predicted by TGD . . . . .	114
4.2.1	The new view about the relationship between gravitational and inertial energy . . . . .	114
4.2.2	Generalized four-wave mechanism as a basic mechanism of remote metabolism . . . . .	115

4.2.3	The classical $Z^0$ fields as TGD counterpart for torsion fields . . . . .	117
4.2.4	Gravitational anomalies and many-sheeted space-time . . . . .	118
4.2.5	Questions related to the vacuum charge densities associated with rotating systems . . . . .	119
4.3	About strange effects related to rotating magnetic systems . . . . .	121
4.3.1	The experiment, the observed effects, and their interpretation in TGD framework . . . . .	121
4.3.2	The electric fields associated with rotating magnetic fields . . . . .	126
4.3.3	A classical model for the weight change and spontaneous acceleration involving only em and $Z^0$ fields and Faraday effect . . . . .	128
4.3.4	The role of the material composition of the system . . . . .	147
4.3.5	Magnetic fields associated with the Searl device . . . . .	153
4.3.6	Remote energy and angular momentum transfer in rotating magnetic systems . . . . .	155
4.3.7	Connection with the dark matter hierarchy . . . . .	158
4.3.8	A general catastrophe theoretic model for the spontaneous acceleration . . . . .	160
4.3.9	Discussion . . . . .	163
4.4	Effects related to Searl effect . . . . .	166
4.4.1	N-machine of DePalma and space-energy generator of Tewari . . . . .	166
4.4.2	Some anomalies related to the behavior of spinning systems . . . . .	167
4.5	Project Flyaway and Searl effect . . . . .	168
4.6	Project Flyaway and Searl effect . . . . .	168
4.6.1	Description of the device . . . . .	168
4.6.2	About the bi-filar coils . . . . .	169
4.6.3	Trying to explain the claimed effects . . . . .	170
4.7	More about magnetic motors . . . . .	173
4.7.1	Observations . . . . .	173
4.7.2	Explanation for the absence of eddy currents . . . . .	174
4.7.3	AC or DC motor cannot be in question . . . . .	175
4.7.4	What could be the source of power and angular momentum? . . . . .	175
4.7.5	A TGD inspired model for Yildiz motor . . . . .	180
4.7.6	Cautious conclusion and questions . . . . .	183
4.8	Rotating systems and dark matter . . . . .	185
4.8.1	$h_{eff} = nh$ hierarchy from biological anomalies . . . . .	185
4.8.2	Nottale's findings and gravitational Planck constant $h_{gr}$ . . . . .	185
4.8.3	Pollack's exclusion zones and fourth phase of water . . . . .	186
4.8.4	Does ATP synthase realize rotating magnetic system accompanied by dark matter with large $h_{em}$ ? . . . . .	186
4.8.5	Could rotating magnetic systems give rise to dark matter? . . . . .	187
4.9	Appendix . . . . .	187
4.9.1	Miscellaneous considerations . . . . .	187
4.9.2	Some general facts about classical solutions of field equations . . . . .	191
4.9.3	Could spontaneous acceleration be due to the change of inertial mass? . . . . .	192
<b>5</b>	<b>Did Tesla Discover the Mechanism Changing the Arrow of Time?</b> . . . . .	<b>197</b>
5.1	Introduction . . . . .	197
5.2	Discussion of the basic ideas and concepts . . . . .	198
5.2.1	Do negative energy space-time sheets have counterparts in quantum field theory? . . . . .	198
5.2.2	Is the TGD view about phase conjugate waves consistent with the existent wisdom? . . . . .	200
5.2.3	Pulses, Tesla transformers, and binary coils . . . . .	203
5.2.4	Could negative energy photons induce the transition to effective superconductivity? . . . . .	207
5.3	The scalar waves of Tesla in TGD framework . . . . .	207
5.3.1	The properties of the scalar waves . . . . .	208
5.3.2	Could nonlinearity of TGD allow scalar waves? . . . . .	208
5.3.3	Lowest order solution ansatz . . . . .	209

5.3.4	First order corrections to the solution ansatz . . . . .	210
5.3.5	Properties of the solution ansatz . . . . .	212
5.3.6	More general solutions representing electric field of constant action density are possible . . . . .	212
5.3.7	Support for Tesla's scalar waves/classical $Z^0$ MEs . . . . .	213
5.4	Does the model explain the basic observations of Tesla? . . . . .	215
5.4.1	Switching the current on as a time reversal for switching the current off . . .	215
5.4.2	Do scalar wave pulses appear also outside electric circuits? . . . . .	216
5.4.3	Why the radiation observed by Tesla was so difficult to detect using photog- raphy? . . . . .	217
5.4.4	How Tesla transformer manages to yield so high voltage amplification? . . .	217
5.4.5	Why no current was observed in the secondaries of Tesla transformers? . . .	218
5.5	Super-luminal velocities, massless extremals, and quantum jumps between quantum histories . . . . .	218
5.5.1	General model for super-luminal velocities . . . . .	219
5.5.2	Quantitative model . . . . .	221
5.5.3	Possible technological implications . . . . .	224
5.6	Figures and illustrations . . . . .	225
<b>6</b>	<b>About Concrete Realization of Remote Metabolism</b>	<b>229</b>
6.1	Introduction . . . . .	229
6.1.1	Short glossary about the basic concepts of TGD . . . . .	229
6.1.2	Plan of the chapter . . . . .	232
6.2	Quantum credit card . . . . .	233
6.2.1	Two realizations for the "population inverted laser" . . . . .	234
6.2.2	Support for quantum credit card mechanism . . . . .	234
6.3	Comparison of Ling's vision of the cell to TGD view . . . . .	236
6.3.1	Ling's basic ideas and concepts . . . . .	236
6.3.2	The fundamentals of Ling's vision from TGD view point . . . . .	237
6.3.3	The role of ATP according to Ling and in TGD framework . . . . .	241
6.3.4	Ling's theory from the perspective of TGD inspired theory of consciousness . . . . .	243
6.4	Capacitor-like Josephson junctions as systems with large $\hbar_{eff}/\hbar$ ? . . . . .	244
6.4.1	Cell membrane as Josephson junction . . . . .	244
6.4.2	Quantization of the DC voltage of capacitor from the quantization of charge . . . . .	246
6.4.3	Constraint on cyclotron frequency . . . . .	247
6.4.4	What about more general capacitor-like systems? . . . . .	248
6.4.5	What $f_J = f_{AC}/l$ condition implies for Earth's electric field? . . . . .	249
6.4.6	Cell membrane, DNA double strand, and cortical layers as capacitor-like Josephson junctions . . . . .	250
6.4.7	Further comments . . . . .	254
6.5	Tesla's work, biology, and TGD . . . . .	255
6.5.1	Tesla's work . . . . .	256
6.5.2	Scalar waves of Tesla in TGD framework . . . . .	257
6.5.3	Relating Tesla's work to TGD inspired quantum biology . . . . .	258
6.5.4	How could this picture relate to biofield research? . . . . .	268
6.5.5	Tesla coils from TGD view point . . . . .	269
6.5.6	Tesla's findings from a new viewpoint . . . . .	277
<b>7</b>	<b>Summary of TGD Inspired Ideas about Free Energy</b>	<b>281</b>
7.1	Introduction . . . . .	281
7.2	Cold fusion and Trojan horse mechanism . . . . .	283
7.2.1	Exotic quarks and charged color bonds as a common denominator of anomalous phenomena . . . . .	283
7.2.2	The experiments of Ditmire <i>et al</i> . . . . .	284
7.2.3	Brief summary of cold fusion . . . . .	285
7.2.4	TGD inspired model of cold fusion . . . . .	287
7.2.5	Do nuclear reaction rates depend on environment? . . . . .	290

7.3	Cold fusion, plasma electrolysis, biological transmutations, and burning salt water	292
7.3.1	The data	292
7.3.2	$H_{1.5}O$ anomaly and nuclear string model	293
7.3.3	A model for the observations of Mizuno	296
7.3.4	Comparison with the model of deuterium cold fusion	299
7.3.5	What happens to $OH$ bonds in plasma electrolysis?	300
7.3.6	A model for plasma electrolysis	302
7.3.7	Tests and improvements	306
7.4	Anomalies possibly related to electrolysis of water and cold fusion	307
7.4.1	Burning salt water by radio-waves and cold fusion by plasma electrolysis	307
7.4.2	Could q-Laguerre equation relate to the claimed fractionation of the principal quantum number for hydrogen atom?	309
7.4.3	Comparison with the reports about biological transmutations	315
7.4.4	Are the abundances of heavier elements determined by cold fusion in interstellar medium?	316
7.5	Cold fusion and sonoluminescence	318
7.5.1	Basic ideas about cold fusion	318
7.5.2	Does Rossi's reactor give rise to cold fusion?	321
7.5.3	Sono-luminescence, classical $Z^0$ force, and hydrodynamic hierarchy of p-adic length scales	325
7.6	The TGD variant of the model of Widom and Larsen for cold fusion	328
7.6.1	Challenges of the model	328
7.6.2	TGD variant of the model	329
7.7	Does ZPE have TGD counterpart?	330
7.7.1	Moddell and ZPE	331
7.7.2	To what ZPE corresponds in TGD Universe?	333
7.7.3	Hierarchy of Planck constants	335
7.7.4	How p-adic length scale hypothesis and hierarchy of Planck constants are related?	336
7.8	TGD inspired model of Brown's gas and related phenomena	337
7.8.1	Brown's gas	337
7.8.2	Pollack's findings about fourth phase of water	339
7.8.3	A model for Brown's gas	346
7.8.4	About implications of the new view about what happens in water splitting	350
7.8.5	Lightings and life	350
7.8.6	Could electrolysis alone produce energy?	351
7.8.7	Comment about hydrinos	351
7.8.8	Does dark biology represent pre- or post-biotic evolution?	352
<b>8</b>	<b>Ufos, Aliens, and the New Physics</b>	<b>355</b>
8.1	Introduction	355
8.2	Basic vision	356
8.2.1	Quantum-classical correspondence	356
8.2.2	Classical physics as exact part of quantum theory	356
8.2.3	p-Adic physics as physics of cognition and intentionality	358
8.2.4	The core ideas of TGD inspired theory of consciousness and quantum biology	361
8.3	TGD based view about life	363
8.3.1	The notion of magnetic body	363
8.3.2	Time mirror mechanism as a fundamental mechanism transforming intentions to actions	366
8.3.3	Applications of time mirror mechanism	367
8.3.4	Vision about the evolution of life	369
8.3.5	Could simple life forms be induced by intentional action?	373
8.4	Great vision about biological evolution and evolution of brain	379
8.4.1	Basic assumptions	379
8.4.2	Dark matter hierarchy and big leaps in evolution	385
8.4.3	Could insect colonies have "EEG"?	392

8.4.4	Dark matter hierarchy, hierarchical structure of nervous system, and hierarchy of emotions . . . . .	395
8.5	How advanced civilization could study cosmos? . . . . .	398
8.5.1	Why space travel is not a good idea? . . . . .	398
8.5.2	Time mirror mechanism as an ideal tool for the study of the Universe . . . . .	398
8.5.3	What aliens are? . . . . .	399
8.5.4	Have more advanced civilizations performed genetic engineering at Earth? . . . . .	401
8.5.5	Fermi paradox . . . . .	402
8.5.6	Dark matter hierarchy as a solution of Fermi paradox? . . . . .	403
8.6	What UFOs are? . . . . .	404
8.6.1	UFOs as plasmoids? . . . . .	404
8.6.2	UFOs made of copper and steel? . . . . .	405
8.6.3	Are flying saucers necessarily living systems? . . . . .	405
8.7	Figures and illustrations . . . . .	405
<b>1</b>	<b>Appendix</b>	<b>411</b>
A-1	Imbedding space $M^4 \times CP_2$ and related notions . . . . .	411
A-2	Basic facts about $CP_2$ . . . . .	412
A-2.1	$CP_2$ as a manifold . . . . .	412
A-2.2	Metric and Kähler structure of $CP_2$ . . . . .	413
A-2.3	Spinors in $CP_2$ . . . . .	415
A-2.4	Geodesic sub-manifolds of $CP_2$ . . . . .	415
A-3	$CP_2$ geometry and standard model symmetries . . . . .	416
A-3.1	Identification of the electro-weak couplings . . . . .	416
A-3.2	Discrete symmetries . . . . .	420
A-4	The relationship of TGD to QFT and string models . . . . .	420
A-5	Induction procedure and many-sheeted space-time . . . . .	421
A-5.1	Many-sheeted space-time . . . . .	422
A-5.2	Imbedding space spinors and induced spinors . . . . .	424
A-5.3	Space-time surfaces with vanishing em, $Z^0$ , or Kähler fields . . . . .	425
A-6	p-Adic numbers and TGD . . . . .	427
A-6.1	p-Adic number fields . . . . .	427
A-6.2	Canonical correspondence between p-adic and real numbers . . . . .	428
A-6.3	The notion of p-adic manifold . . . . .	431
A-7	Hierarchy of Planck constants and dark matter hierarchy . . . . .	431
A-8	Some notions relevant to TGD inspired consciousness and quantum biology . . . . .	432
A-8.1	The notion of magnetic body . . . . .	432
A-8.2	Number theoretic entropy and negentropic entanglement . . . . .	433
A-8.3	Life as something residing in the intersection of reality and p-adicities . . . . .	433
A-8.4	Sharing of mental images . . . . .	433
A-8.5	Time mirror mechanism . . . . .	433

# List of Figures

4.1	Variant of one-ring converter (figure 25 in [H47]). . . . .	122
4.2	The general view of the converter and its platform (figure 26 in [H47]). . . . .	122
4.3	Magnetic inserts could make possible magnetic cogwheel mechanism (figure 27 in [H47]). . . . .	123
4.4	The development of the change of weight as function of rotation frequency (figure 28 in [H47]). . . . .	124
4.5	Cusp catastrophe . . . . .	137
5.1	Time mirror mechanism . . . . .	225
5.2	a) The structure of bi-filar coils and the mechanical analog of RCL circuit as a harmonic oscillator. b) The reduction of the mass of the harmonic oscillator at the second half of the magnetic pulse implies acceleration and generation of negative energy photons in order to get energy. . . . .	226
5.3	A mechanism of energy production based on negative energy topological light rays and population inversion. . . . .	226
5.4	Constant voltage pulse (a) and the corresponding electric (b) and magnetic (c) pulses in the bi-filar coil. . . . .	226
5.5	Rational valued points $x$ and $y = x + p^n$ , which are close to each other p-adically, are far from each other in real sense. . . . .	227
5.6	The non-determinism of p-adic differential equations in the case of a free particle. a) In real case the initial position $x_0$ and and velocity $v$ determine the orbit. b) In the p-adic case $x_0$ and $v$ are piecewise constant functions of time and the orbit resembles that associated with Brown motion. . . . .	227
5.7	Rational numbers are common to both reals $R$ and all p-adic number fields $R_p$ , $p = 2, 3, \dots$ . These number fields can be "glued" together along the rational numbers to form a book like structure. Rational numbers correspond to the rim of the book and different number fields to its pages. . . . .	227
8.1	Transformation of intention to action as real-to-p-adc transformation and realization of intention as action as its reversal. . . . .	360
8.2	Space-times can be regarded as 4-dimensional surfaces in 8-dimensional space $H = M_+^4 \times CP_2$ obtained by replacing points of future light cone of Minkowski space with $CP_2$ . . . . .	406
8.3	Material objects correspond to the sheets of the many-sheeted space-time. Note that sheets are extremely near to each other. . . . .	406
8.4	The space-time sheets condensed on larger space-time sheets having no join along boundaries bonds can be connected by join along boundaries bonds. This forces to generalize the notion of sub-system and makes possible sharing of mental images. . . . .	407
8.5	Generalization of the number concept: real and p-adic number fields correspond to the pages of book and the rim of book corresponds to rational numbers common to all of them. . . . .	407
8.6	The transformation of p-adic space-time sheet to a real one in quantum jump correspond to the transformation of intention to action. . . . .	408
8.7	Quantum entangled systems lose their identify. Schrödinger cat entangled with the poisson bottle is neither living nor dead or is both simultaneously. . . . .	408



8.8 Arecibo message provides information about us. . . . . 409

8.9 Chilbolton crop formation of figure a) is made using the same format as Arecibo message and can be interpreted as providing information about the constructors of the formation. Figure b) is the counterpart of radio antenna used to generate the message. A possible interpretation is as magnetosphere which suggests that the conscious entity responsible for the generation of crop circles is entity magnetosphere, brain of Mother Gaia. . . . . 409

8.10 Time mirror mechanism . . . . . 410

# Chapter 1

## Introduction

### 1.1 Basic Ideas of Topological Geometrodynamics (TGD)

Standard model describes rather successfully both electroweak and strong interactions but sees them as totally separate and contains a large number of parameters which it is not able to predict. For about four decades ago unified theories known as Grand Unified Theories (GUTs) trying to understand electroweak interactions and strong interactions as aspects of the same fundamental gauge interaction assignable to a larger symmetry group emerged. Later superstring models trying to unify even gravitation and strong and weak interactions emerged. The shortcomings of both GUTs and superstring models are now well-known. If TGD - whose basic idea emerged 37 years ago - would emerge now it would be seen as an attempt trying to solve the difficulties of these approaches to unification.

The basic physical picture behind TGD corresponds to a fusion of two rather disparate approaches: namely TGD as a Poincare invariant theory of gravitation and TGD as a generalization of the old-fashioned string model. The CMAP files at my homepage provide an overview about ideas and evolution of TGD and make easier to understand what TGD and its applications are about (<http://www.tgdtheory.fi/cmaphtml.html> [L8]).

#### 1.1.1 Basic vision very briefly

*T(opological) G(eometro)D(ynamics)* is one of the many attempts to find a unified description of basic interactions. The development of the basic ideas of TGD to a relatively stable form took time of about half decade [K1].

The basic vision and its relationship to existing theories is now rather well understood.

1. Space-times are representable as 4-surfaces in the 8-dimensional imbedding space  $H = M^4 \times CP_2$ , where  $M^4$  is 4-dimensional (4-D) Minkowski space and  $CP_2$  is 4-D complex projective space (see Appendix).
2. Induction procedure allows to geometrize various fields. Space-time metric characterizing gravitational fields corresponds to the induced metric obtained by projecting the metric tensor of  $H$  to the space-time surface. Electroweak gauge potentials are identified as projections of the components of  $CP_2$  spinor connection to the space-time surface, and color gauge potentials as projections of  $CP_2$  Killing vector fields representing color symmetries. Also spinor structure can be induced: induced spinor gamma matrices are projections of gamma matrices of  $H$  and induced spinor fields just  $H$  spinor fields restricted to space-time surface.
3. Geometrization of quantum numbers is achieved. The isometry group of the geometry of  $CP_2$  codes for the color gauge symmetries of strong interactions. Vierbein group codes for electroweak symmetries, and explains their breaking in terms of  $CP_2$  geometry so that standard model gauge group results. There are also important deviations from standard model: color quantum numbers are not spin-like but analogous to orbital angular momentum: this difference is expected to be seen only in  $CP_2$  scale. In contrast to GUTs, quark and

lepton numbers are separately conserved and family replication has a topological explanation in terms of topology of the partonic 2-surface carrying fermionic quantum numbers.

$M^4$  and  $CP_2$  are unique choices for many other reasons. For instance, they are the unique 4-D space-times allowing twistor space with Kähler structure.  $M^4$  light-cone boundary allows a huge extension of 2-D conformal symmetries. Imbedding space  $H$  has a number theoretic interpretation as 8-D space allowing octonionic tangent space structure.  $M^4$  and  $CP_2$  allow quaternionic structures. Therefore standard model symmetries have number theoretic meaning.

4. Induced gauge potentials are expressible in terms of imbedding space coordinates and their gradients and general coordinate invariance implies that there are only 4 field like variables locally. Situation is thus extremely simple mathematically. The objection is that one loses linear superposition of fields. The resolution of the problem comes from the generalization of the concepts of particle and space-time.

Space-time surfaces can be also particle like having thus finite size. In particular, space-time regions with Euclidian signature of the induced metric (temporal and spatial dimensions in the same role) emerge and have interpretation as lines of generalized Feynman diagrams. Particle in space-time can be identified as a topological inhomogeneity in background space-time surface which looks like the space-time of general relativity in long length scales.

One ends up with a generalization of space-time surface to many-sheeted space-time with space-time sheets having extremely small distance of about  $10^4$  Planck lengths ( $CP_2$  size). As one adds a particle to this kind of structure, it touches various space-time sheets and thus interacts with the associated classical fields. Their effects superpose linearly in good approximation and linear superposition of fields is replaced with that for their effects.

This resolves the basic objection. It also leads to the understanding of how the space-time of general relativity and quantum field theories emerges from TGD space-time as effective space-time when the sheets of many-sheeted space-time are lumped together to form a region of Minkowski space with metric replaced with a metric identified as the sum of empty Minkowski metric and deviations of the metrics of sheets from empty Minkowski metric. Gauge potentials are identified as sums of the induced gauge potentials. TGD is therefore a microscopic theory from which standard model and general relativity follow as a topological simplification however forcing to increase dramatically the number of fundamental field variables.

5. A further objection is that classical weak fields identified as induced gauge fields are long ranged and should cause large parity breaking effects due to weak interactions. These effects are indeed observed but only in living matter. The resolution of problem is implied by the condition that the modes of the induced spinor fields have well-defined electromagnetic charge. This forces their localization to 2-D string world sheets in the generic case having vanishing weak gauge fields so that parity breaking effects emerge just as they do in standard model. Also string model like picture emerges from TGD and one ends up with a rather concrete view about generalized Feynman diagrammatics.

The great challenge is to construct a mathematical theory around these physically very attractive ideas and I have devoted the last thirty seven years for the realization of this dream and this has resulted in eight online books about TGD and nine online books about TGD inspired theory of consciousness and of quantum biology.

### 1.1.2 Two manners to see TGD and their fusion

As already mentioned, TGD can be interpreted both as a modification of general relativity and generalization of string models.

#### TGD as a Poincare invariant theory of gravitation

The first approach was born as an attempt to construct a Poincare invariant theory of gravitation. Space-time, rather than being an abstract manifold endowed with a pseudo-Riemannian structure,

is regarded as a surface in the 8-dimensional space  $H = M^4 \times CP_2$ , where  $M^4$  denotes Minkowski space and  $CP_2 = SU(3)/U(2)$  is the complex projective space of two complex dimensions [A13, A5, A10, A4].

The identification of the space-time as a sub-manifold [A3, A12] of  $M^4 \times CP_2$  leads to an exact Poincare invariance and solves the conceptual difficulties related to the definition of the energy-momentum in General Relativity.

It soon however turned out that sub-manifold geometry, being considerably richer in structure than the abstract manifold geometry, leads to a geometrization of all basic interactions. First, the geometrization of the elementary particle quantum numbers is achieved. The geometry of  $CP_2$  explains electro-weak and color quantum numbers. The different H-chiralities of  $H$ -spinors correspond to the conserved baryon and lepton numbers. Secondly, the geometrization of the field concept results. The projections of the  $CP_2$  spinor connection, Killing vector fields of  $CP_2$  and of  $H$ -metric to four-surface define classical electro-weak, color gauge fields and metric in  $X^4$ .

The choice of  $H$  is unique from the condition that TGD has standard model symmetries. Also number theoretical vision selects  $H = M^4 \times CP_2$  uniquely.  $M^4$  and  $CP_2$  are also unique spaces allowing twistor space with Kähler structure.

### TGD as a generalization of the hadronic string model

The second approach was based on the generalization of the mesonic string model describing mesons as strings with quarks attached to the ends of the string. In the 3-dimensional generalization 3-surfaces correspond to free particles and the boundaries of the 3- surface correspond to partons in the sense that the quantum numbers of the elementary particles reside on the boundaries. Various boundary topologies (number of handles) correspond to various fermion families so that one obtains an explanation for the known elementary particle quantum numbers. This approach leads also to a natural topological description of the particle reactions as topology changes: for instance, two-particle decay corresponds to a decay of a 3-surface to two disjoint 3-surfaces.

This decay vertex does not however correspond to a direct generalization of trouser vertex of string models. Indeed, the important difference between TGD and string models is that the analogs of string world sheet diagrams do not describe particle decays but the propagation of particles via different routes. Particle reactions are described by generalized Feynman diagrams for which 3-D light-like surface describing particle propagating join along their ends at vertices. As 4-manifolds the space-time surfaces are therefore singular like Feynman diagrams as 1-manifolds.

### Fusion of the two approaches via a generalization of the space-time concept

The problem is that the two approaches to TGD seem to be mutually exclusive since the orbit of a particle like 3-surface defines 4-dimensional surface, which differs drastically from the topologically trivial macroscopic space-time of General Relativity. The unification of these approaches forces a considerable generalization of the conventional space-time concept. First, the topologically trivial 3-space of General Relativity is replaced with a "topological condensate" containing matter as particle like 3-surfaces "glued" to the topologically trivial background 3-space by connected sum operation. Secondly, the assumption about connectedness of the 3-space is given up. Besides the "topological condensate" there could be "vapor phase" that is a "gas" of particle like 3-surfaces and string like objects (counterpart of the "baby universes" of GRT) and the non-conservation of energy in GRT corresponds to the transfer of energy between different sheets of the space-time and possibly existence vapour phase.

What one obtains is what I have christened as many-sheeted space-time (see fig. <http://www.tgdtheory.fi/appfigures/manysheeted.jpg> or fig. 9 in the appendix of this book). One particular aspect is topological field quantization meaning that various classical fields assignable to a physical system correspond to space-time sheets representing the classical fields to that particular system. One can speak of the field body of a particular physical system. Field body consists of topological light rays, and electric and magnetic flux quanta. In Maxwell's theory system does not possess this kind of field identity. The notion of magnetic body is one of the key players in TGD inspired theory of consciousness and quantum biology.

This picture became more detailed with the advent of zero energy ontology (ZEO). The basic notion of ZEO is causal diamond (CD) identified as the Cartesian product of  $CP_2$  and of the

intersection of future and past directed light-cones and having scale coming as an integer multiple of  $CP_2$  size is fundamental. CDs form a fractal hierarchy and zero energy states decompose to products of positive and negative energy parts assignable to the opposite boundaries of CD defining the ends of the space-time surface. The counterpart of zero energy state in positive energy ontology is the pair of initial and final states of a physical event, say particle reaction.

At space-time level ZEO means that 3-surfaces are pairs of space-like 3-surfaces at the opposite light-like boundaries of CD. Since the extremals of Kähler action connect these, one can say that by holography the basic dynamical objects are the space-time surface connecting these 3-surfaces. This changes totally the vision about notions like self-organization: self-organization by quantum jumps does not take for a 3-D system but for the entire 4-D field pattern associated with it.

General Coordinate Invariance (GCI) allows to identify the basic dynamical objects as space-like 3-surfaces at the ends of space-time surface at boundaries of CD: this means that space-time surface is analogous to Bohr orbit. An alternative identification is as light-like 3-surfaces at which the signature of the induced metric changes from Minkowskian to Euclidian and interpreted as lines of generalized Feynman diagrams. Also the Euclidian 4-D regions would have similar interpretation. The requirement that the two interpretations are equivalent, leads to a strong form of General Coordinate Invariance. The outcome is effective 2-dimensionality stating that the partonic 2-surfaces identified as intersections of the space-like ends of space-time surface and light-like wormhole throats are the fundamental objects. That only effective 2-dimensionality is in question is due to the effects caused by the failure of strict determinism of Kähler action. In finite length scale resolution these effects can be neglected below UV cutoff and above IR cutoff. One can also speak about strong form of holography.

### 1.1.3 Basic objections

Objections are the most powerful tool in theory building. The strongest objection against TGD is the observation that all classical gauge fields are expressible in terms of four imbedding space coordinates only- essentially  $CP_2$  coordinates. The linear superposition of classical gauge fields taking place independently for all gauge fields is lost. This would be a catastrophe without many-sheeted space-time. Instead of gauge fields, only the effects such as gauge forces are superposed. Particle topologically condenses to several space-time sheets simultaneously and experiences the sum of gauge forces. This transforms the weakness to extreme economy: in a typical unified theory the number of primary field variables is countered in hundreds if not thousands, now it is just four.

Second objection is that TGD space-time is quite too simple as compared to GRT space-time due to the imbeddability to 8-D imbedding space. One can also argue that Poincare invariant theory of gravitation cannot be consistent with General Relativity. The above interpretation allows to understand the relationship to GRT space-time and how Equivalence Principle (EP) follows from Poincare invariance of TGD. The interpretation of GRT space-time is as effective space-time obtained by replacing many-sheeted space-time with Minkowski space with effective metric determined as a sum of Minkowski metric and sum over the deviations of the induced metrics of space-time sheets from Minkowski metric. Poincare invariance suggests strongly classical EP for the GRT limit in long length scales at least. One can consider also other kinds of limits such as the analog of GRT limit for Euclidian space-time regions assignable to elementary particles. In this case deformations of  $CP_2$  metric define a natural starting point and  $CP_2$  indeed defines a gravitational instanton with very large cosmological constant in Einstein-Maxwell theory. Also gauge potentials of standard model correspond classically to superpositions of induced gauge potentials over space-time sheets.

### Topological field quantization

Topological field quantization distinguishes between TGD based and more standard - say Maxwellian - notion of field. In Maxwell's fields created by separate systems superpose and one cannot tell which part of field comes from which system except theoretically. In TGD these fields correspond to different space-time sheets and only their effects on test particle superpose. Hence physical systems have well-defined field identifies - field bodies - in particular magnetic bodies.

The notion of magnetic body carrying dark matter with non-standard large value of Planck constant has become central concept in TGD inspired theory of consciousness and living matter,

and by starting from various anomalies of biology one ends up to a rather detailed view about the role of magnetic body as intentional agent receiving sensory input from the biological body and controlling it using EEG and its various scaled up variants as a communication tool. Among other things this leads to models for cell membrane, nerve pulse, and EEG.

#### 1.1.4 p-Adic variants of space-time surfaces

There is a further generalization of the space-time concept inspired by p-adic physics forcing a generalization of the number concept through the fusion of real numbers and various p-adic number fields. Also the hierarchy of Planck constants forces a generalization of the notion of space-time but this generalization can be understood in terms of the failure of strict determinism for Kähler action defining the fundamental variational principle behind the dynamics of space-time surfaces.

A very concise manner to express how TGD differs from Special and General Relativities could be following. Relativity Principle (Poincare Invariance), General Coordinate Invariance, and Equivalence Principle remain true. What is new is the notion of sub-manifold geometry: this allows to realize Poincare Invariance and geometrize gravitation simultaneously. This notion also allows a geometrization of known fundamental interactions and is an essential element of all applications of TGD ranging from Planck length to cosmological scales. Sub-manifold geometry is also crucial in the applications of TGD to biology and consciousness theory.

#### 1.1.5 The threads in the development of quantum TGD

The development of TGD has involved several strongly interacting threads: physics as infinite-dimensional geometry; TGD as a generalized number theory, the hierarchy of Planck constants interpreted in terms of dark matter hierarchy, and TGD inspired theory of consciousness. In the following these threads are briefly described.

The theoretical framework involves several threads.

1. Quantum T(opological) G(eometro)D(ynamics) as a classical spinor geometry for infinite-dimensional WCW, p-adic numbers and quantum TGD, and TGD inspired theory of consciousness and of quantum biology have been for last decade of the second millenium the basic three strongly interacting threads in the tapestry of quantum TGD.
2. The discussions with Tony Smith initiated a fourth thread which deserves the name 'TGD as a generalized number theory'. The basic observation was that classical number fields might allow a deeper formulation of quantum TGD. The work with Riemann hypothesis made time ripe for realization that the notion of infinite primes could provide, not only a reformulation, but a deep generalization of quantum TGD. This led to a thorough and extremely fruitful revision of the basic views about what the final form and physical content of quantum TGD might be. Together with the vision about the fusion of p-adic and real physics to a larger coherent structure these sub-threads fused to the "physics as generalized number theory" thread.
3. A further thread emerged from the realization that by quantum classical correspondence TGD predicts an infinite hierarchy of macroscopic quantum systems with increasing sizes, that it is not at all clear whether standard quantum mechanics can accommodate this hierarchy, and that a dynamical quantized Planck constant might be necessary and strongly suggested by the failure of strict determinism for the fundamental variational principle. The identification of hierarchy of Planck constants labelling phases of dark matter would be natural. This also led to a solution of a long standing puzzle: what is the proper interpretation of the predicted fractal hierarchy of long ranged classical electro-weak and color gauge fields. Quantum classical correspondences allows only single answer: there is infinite hierarchy of p-adically scaled up variants of standard model physics and for each of them also dark hierarchy. Thus TGD Universe would be fractal in very abstract and deep sense.

The chronology based identification of the threads is quite natural but not logical and it is much more logical to see p-adic physics, the ideas related to classical number fields, and infinite

primes as sub-threads of a thread which might be called "physics as a generalized number theory". In the following I adopt this view. This reduces the number of threads to four.

TGD forces the generalization of physics to a quantum theory of consciousness, and represent TGD as a generalized number theory vision leads naturally to the emergence of p-adic physics as physics of cognitive representations. The eight online books [K83, K62, K47, K96, K72, K95, K94, K70] about TGD and nine online books about TGD inspired theory of consciousness and of quantum biology [K76, K13, K53, K11, K30, K38, K42, K69, K89] are warmly recommended to the interested reader.

### Quantum TGD as spinor geometry of World of Classical Worlds

A turning point in the attempts to formulate a mathematical theory was reached after seven years from the birth of TGD. The great insight was "Do not quantize". The basic ingredients to the new approach have served as the basic philosophy for the attempt to construct Quantum TGD since then and have been the following ones:

1. Quantum theory for extended particles is free(!), classical(!) field theory for a generalized Schrödinger amplitude in the configuration space  $CH$  ("world of classical worlds", WCW) consisting of all possible 3-surfaces in  $H$ . "All possible" means that surfaces with arbitrary many disjoint components and with arbitrary internal topology and also singular surfaces topologically intermediate between two different manifold topologies are included. Particle reactions are identified as topology changes [A8, A14, A15]. For instance, the decay of a 3-surface to two 3-surfaces corresponds to the decay  $A \rightarrow B + C$ . Classically this corresponds to a path of WCW leading from 1-particle sector to 2-particle sector. At quantum level this corresponds to the dispersion of the generalized Schrödinger amplitude localized to 1-particle sector to two-particle sector. All coupling constants should result as predictions of the theory since no nonlinearities are introduced.
2. During years this naive and very rough vision has of course developed a lot and is not anymore quite equivalent with the original insight. In particular, the space-time correlates of Feynman graphs have emerged from theory as Euclidian space-time regions and the strong form of General Coordinate Invariance has led to a rather detailed and in many respects unexpected visions. This picture forces to give up the idea about smooth space-time surfaces and replace space-time surface with a generalization of Feynman diagram in which vertices represent the failure of manifold property. I have also introduced the word "world of classical worlds" (WCW) instead of rather formal "configuration space". I hope that "WCW" does not induce despair in the reader having tendency to think about the technicalities involved!
3. WCW is endowed with metric and spinor structure so that one can define various metric related differential operators, say Dirac operator, appearing in the field equations of the theory <sup>1</sup>. The most ambitious dream is that zero energy states correspond to a complete solution basis for the Dirac operator of WCW so that this classical free field theory would dictate M-matrices defined between positive and negative energy parts of zero energy states which form orthonormal rows of what I call U-matrix as a matrix defined between zero energy states. Given M-matrix in turn would decompose to a product of a hermitian density matrix and unitary S-matrix.

M-matrix would define time-like entanglement coefficients between positive and negative energy parts of zero energy states (all net quantum numbers vanish for them) and can be regarded as a hermitian square root of density matrix multiplied by a unitary S-matrix. Quantum theory would be in well-defined sense a square root of thermodynamics. The orthogonality and hermiticity of the complex square roots of density matrices commuting with S-matrix means that they span infinite-dimensional Lie algebra acting as symmetries of the S-matrix. Therefore quantum TGD would reduce to group theory in well-defined sense: its own symmetries would define the symmetries of the theory. In fact the Lie algebra of Hermitian M-matrices extends to Kac-Moody type algebra obtained by multiplying hermitian

<sup>1</sup>There are four kinds of Dirac operators in TGD. WCW Dirac operator appearing in Super-Virasoro conditions, imbedding space Dirac operator whose modes define the ground states of Super-Virasoro representations, Kähler-Dirac operator at space-time surfaces, and the algebraic variant of  $M^4$  Dirac operator appearing in propagators

square roots of density matrices with powers of the S-matrix. Also the analog of Yangian algebra involving only non-negative powers of S-matrix is possible.

4. By quantum classical correspondence the construction of WCW spinor structure reduces to the second quantization of the induced spinor fields at space-time surface. The basic action is so called modified Dirac action (or Kähler-Dirac action) in which gamma matrices are replaced with the modified (Kähler-Dirac) gamma matrices defined as contractions of the canonical momentum currents with the imbedding space gamma matrices. In this manner one achieves super-conformal symmetry and conservation of fermionic currents among other things and consistent Dirac equation. The modified gamma matrices define as anti-commutators effective metric, which might provide geometrization for some basic observables of condensed matter physics. One might also talk about bosonic emergence in accordance with the prediction that the gauge bosons and graviton are expressible in terms of bound states of fermion and anti-fermion.
5. An important result relates to the notion of induced spinor connection. If one requires that spinor modes have well-defined em charge, one must assume that the modes in the generic situation are localized at 2-D surfaces - string world sheets or perhaps also partonic 2-surfaces - at which classical  $W$  boson fields vanish. Covariantly constant right handed neutrino generating super-symmetries forms an exception. The vanishing of also  $Z^0$  field is possible for Kähler-Dirac action and should hold true at least above weak length scales. This implies that string model in 4-D space-time becomes part of TGD. Without these conditions classical weak fields can vanish above weak scale only for the GRT limit of TGD for which gauge potentials are sums over those for space-time sheets.

The localization simplifies enormously the mathematics and one can solve exactly the Kähler-Dirac equation for the modes of the induced spinor field just like in super string models.

At the light-like 3-surfaces at which the signature of the induced metric changes from Euclidian to Minkowskian so that  $\sqrt{g_4}$  vanishes one can pose the condition that the algebraic analog of massless Dirac equation is satisfied by the nodes so that Kähler-Dirac action gives massless Dirac propagator localizable at the boundaries of the string world sheets.

The evolution of these basic ideas has been rather slow but has gradually led to a rather beautiful vision. One of the key problems has been the definition of Kähler function. Kähler function is Kähler action for a preferred extremal assignable to a given 3-surface but what this preferred extremal is? The obvious first guess was as absolute minimum of Kähler action but could not be proven to be right or wrong. One big step in the progress was boosted by the idea that TGD should reduce to almost topological QFT in which braids would replace 3-surfaces in finite measurement resolution, which could be inherent property of the theory itself and imply discretization at partonic 2-surfaces with discrete points carrying fermion number.

1. TGD as almost topological QFT vision suggests that Kähler action for preferred extremals reduces to Chern-Simons term assigned with space-like 3-surfaces at the ends of space-time (recall the notion of causal diamond (CD)) and with the light-like 3-surfaces at which the signature of the induced metric changes from Minkowskian to Euclidian. Minkowskian and Euclidian regions would give at wormhole throats the same contribution apart from coefficients and in Minkowskian regions the  $\sqrt{g_4}$  factor coming from metric would be imaginary so that one would obtain sum of real term identifiable as Kähler function and imaginary term identifiable as the ordinary Minkowskian action giving rise to interference effects and stationary phase approximation central in both classical and quantum field theory.

Imaginary contribution - the presence of which I realized only after 33 years of TGD - could also have topological interpretation as a Morse function. On physical side the emergence of Euclidian space-time regions is something completely new and leads to a dramatic modification of the ideas about black hole interior.

2. The manner to achieve the reduction to Chern-Simons terms is simple. The vanishing of Coulomb contribution to Kähler action is required and is true for all known extremals if one makes a general ansatz about the form of classical conserved currents. The so called weak



form of electric-magnetic duality defines a boundary condition reducing the resulting 3-D terms to Chern-Simons terms. In this manner almost topological QFT results. But only "almost" since the Lagrange multiplier term forcing electric-magnetic duality implies that Chern-Simons action for preferred extremals depends on metric.

### TGD as a generalized number theory

Quantum T(opological)D(ynamics) as a classical spinor geometry for infinite-dimensional configuration space ("world of classical worlds", WCW), p-adic numbers and quantum TGD, and TGD inspired theory of consciousness, have been for last ten years the basic three strongly interacting threads in the tapestry of quantum TGD. The fourth thread deserves the name 'TGD as a generalized number theory'. It involves three separate threads: the fusion of real and various p-adic physics to a single coherent whole by requiring number theoretic universality discussed already, the formulation of quantum TGD in terms of hyper-counterparts of classical number fields identified as sub-spaces of complexified classical number fields with Minkowskian signature of the metric defined by the complexified inner product, and the notion of infinite prime.

#### 1. *p-Adic TGD and fusion of real and p-adic physics to single coherent whole*

The p-adic thread emerged for roughly ten years ago as a dim hunch that p-adic numbers might be important for TGD. Experimentation with p-adic numbers led to the notion of canonical identification mapping reals to p-adics and vice versa. The breakthrough came with the successful p-adic mass calculations using p-adic thermodynamics for Super-Virasoro representations with the super-Kac-Moody algebra associated with a Lie-group containing standard model gauge group. Although the details of the calculations have varied from year to year, it was clear that p-adic physics reduces not only the ratio of proton and Planck mass, the great mystery number of physics, but all elementary particle mass scales, to number theory if one assumes that primes near prime powers of two are in a physically favored position. Why this is the case, became one of the key puzzles and led to a number of arguments with a common gist: evolution is present already at the elementary particle level and the primes allowed by the p-adic length scale hypothesis are the fittest ones.

It became very soon clear that p-adic topology is not something emerging in Planck length scale as often believed, but that there is an infinite hierarchy of p-adic physics characterized by p-adic length scales varying to even cosmological length scales. The idea about the connection of p-adics with cognition motivated already the first attempts to understand the role of the p-adics and inspired 'Universe as Computer' vision but time was not ripe to develop this idea to anything concrete (p-adic numbers are however in a central role in TGD inspired theory of consciousness). It became however obvious that the p-adic length scale hierarchy somehow corresponds to a hierarchy of intelligences and that p-adic prime serves as a kind of intelligence quotient. Ironically, the almost obvious idea about p-adic regions as cognitive regions of space-time providing cognitive representations for real regions had to wait for almost a decade for the access into my consciousness.

In string model context one tries to reduce the physics to Planck scale. The price is the inability to say anything about physics in long length scales. In TGD p-adic physics takes care of this shortcoming by predicting the physics also in long length scales.

There were many interpretational and technical questions crying for a definite answer.

1. What is the relationship of p-adic non-determinism to the classical non-determinism of the basic field equations of TGD? Are the p-adic space-time region genuinely p-adic or does p-adic topology only serve as an effective topology? If p-adic physics is direct image of real physics, how the mapping relating them is constructed so that it respects various symmetries? Is the basic physics p-adic or real (also real TGD seems to be free of divergences) or both? If it is both, how should one glue the physics in different number field together to get *the* Physics? Should one perform p-adicization also at the level of the WCW? Certainly the p-adicization at the level of super-conformal representation is necessary for the p-adic mass calculations.
2. Perhaps the most basic and most irritating technical problem was how to precisely define p-adic definite integral which is a crucial element of any variational principle based formulation of the field equations. Here the frustration was not due to the lack of solution but due to the too large number of solutions to the problem, a clear symptom for the sad fact that

clever inventions rather than real discoveries might be in question. Quite recently I however learned that the problem of making sense about p-adic integration has been for decades central problem in the frontier of mathematics and a lot of profound work has been done along same intuitive lines as I have proceeded in TGD framework. The basic idea is certainly the notion of algebraic continuation from the world of rationals belonging to the intersection of real world and various p-adic worlds.

The notion of p-adic manifold [K98] identified as p-adic space-time surface solving p-adic analogs of field equations and having real space-time sheets as chart maps provides a possible solution of the basic challenge. One can also speak of real space-time surfaces having p-adic space-time surfaces as chart maps (cognitive maps, "thought bubbles"). Discretization required having interpretation in terms of finite measurement resolution is unavoidable in this approach.

Despite various uncertainties, the number of the applications of the poorly defined p-adic physics has grown steadily and the applications turned out to be relatively stable so that it was clear that the solution to these problems must exist. It became only gradually clear that the solution of the problems might require going down to a deeper level than that represented by reals and p-adics.

The key challenge is to fuse various p-adic physics and real physics to single larger structures. This has inspired a proposal for a generalization of the notion of number field by fusing real numbers and various p-adic number fields and their extensions along rationals and possible common algebraic numbers. This leads to a generalization of the notions of imbedding space and space-time concept and one can speak about real and p-adic space-time sheets. The quantum dynamics should be such that it allows quantum transitions transforming space-time sheets belonging to different number fields to each other. The space-time sheets in the intersection of real and p-adic worlds are of special interest and the hypothesis is that living matter resides in this intersection. This leads to surprisingly detailed predictions and far reaching conjectures. For instance, the number theoretic generalization of entropy concept allows negentropic entanglement central for the applications to living matter (see fig. <http://www.tgdtheory.fi/appfigures/cat.jpg> or fig. 21 in the appendix of this book).

The basic principle is number theoretic universality stating roughly that the physics in various number fields can be obtained as completion of rational number based physics to various number fields. Rational number based physics would in turn describe physics in finite measurement resolution and cognitive resolution. The notion of finite measurement resolution has become one of the basic principles of quantum TGD and leads to the notions of braids as representatives of 3-surfaces and inclusions of hyper-finite factors as a representation for finite measurement resolution. The braids actually co-emerge with string world sheets implied by the condition that em charge is well-defined for spinor modes.

## 2. The role of classical number fields

The vision about the physical role of the classical number fields relies on certain speculative questions inspired by the idea that space-time dynamics could be reduced to associativity or co-associativity condition. Associativity means here associativity of tangent spaces of space-time region and co-associativity associativity of normal spaces of space-time region.

1. Could space-time surfaces  $X^4$  be regarded as associative or co-associative ("quaternionic" is equivalent with "associative") surfaces of  $H$  endowed with octonionic structure in the sense that tangent space of space-time surface would be associative (co-associative with normal space associative) sub-space of octonions at each point of  $X^4$  [K74]. This is certainly possible and an interesting conjecture is that the preferred extremals of Kähler action include associative and co-associative space-time regions.
2. Could the notion of compactification generalize to that of number theoretic compactification in the sense that one can map associative (co-associative) surfaces of  $M^8$  regarded as octonionic linear space to surfaces in  $M^4 \times CP_2$  [K74]? This conjecture -  $M^8 - H$  duality - would give for  $M^4 \times CP_2$  deep number theoretic meaning.  $CP_2$  would parametrize associative planes of octonion space containing fixed complex plane  $M^2 \subset M^8$  and  $CP_2$  point would thus characterize the tangent space of  $X^4 \subset M^8$ . The point of  $M^4$  would be obtained

by projecting the point of  $X^4 \subset M^8$  to a point of  $M^4$  identified as tangent space of  $X^4$ . This would guarantee that the dimension of space-time surface in  $H$  would be four. The conjecture is that the preferred extremals of Kähler action include these surfaces.

3.  $M^8 - H$  duality can be generalized to a duality  $H \rightarrow H$  if the images of the associative surface in  $M^8$  is associative surface in  $H$ . One can start from associative surface of  $H$  and assume that it contains the preferred  $M^2$  tangent plane in 8-D tangent space of  $H$  or integrable distribution  $M^2(x)$  of them, and its points to  $H$  by mapping  $M^4$  projection of  $H$  point to itself and associative tangent space to  $CP_2$  point. This point need not be the original one! If the resulting surface is also associative, one can iterate the process indefinitely. WCW would be a category with one object.
4.  $G_2$  defines the automorphism group of octonions, and one might hope that the maps of octonions to octonions such that the action of Jacobian in the tangent space of associative or co-associative surface reduces to that of  $G_2$  could produce new associative/co-associative surfaces. The action of  $G_2$  would be analogous to that of gauge group.
5. One can also ask whether the notions of commutativity and co-commutativity could have physical meaning. The well-definedness of em charge as quantum number for the modes of the induced spinor field requires their localization to 2-D surfaces (right-handed neutrino is an exception) - string world sheets and partonic 2-surfaces. This can be possible only for Kähler action and could have commutativity and co-commutativity as a number theoretic counterpart. The basic vision would be that the dynamics of Kähler action realizes number theoretical geometrical notions like associativity and commutativity and their co-notions.

The notion of number theoretic compactification stating that space-time surfaces can be regarded as surfaces of either  $M^8$  or  $M^4 \times CP_2$ . As surfaces of  $M^8$  identifiable as space of hyper-octonions they are hyper-quaternionic or co-hyper-quaternionic- and thus maximally associative or co-associative. This means that their tangent space is either hyper-quaternionic plane of  $M^8$  or an orthogonal complement of such a plane. These surface can be mapped in natural manner to surfaces in  $M^4 \times CP_2$  [K74] provided one can assign to each point of tangent space a hyper-complex plane  $M^2(x) \subset M^4 \subset M^8$ . One can also speak about  $M^8 - H$  duality.

This vision has very strong predictive power. It predicts that the preferred extremals of Kähler action correspond to either hyper-quaternionic or co-hyper-quaternionic surfaces such that one can assign to tangent space at each point of space-time surface a hyper-complex plane  $M^2(x) \subset M^4$ . As a consequence, the  $M^4$  projection of space-time surface at each point contains  $M^2(x)$  and its orthogonal complement. These distributions are integrable implying that space-time surface allows dual slicings defined by string world sheets  $Y^2$  and partonic 2-surfaces  $X^2$ . The existence of this kind of slicing was earlier deduced from the study of extremals of Kähler action and christened as Hamilton-Jacobi structure. The physical interpretation of  $M^2(x)$  is as the space of non-physical polarizations and the plane of local 4-momentum.

Number theoretical compactification has inspired large number of conjectures. This includes dual formulations of TGD as Minkowskian and Euclidian string model type theories, the precise identification of preferred extremals of Kähler action as extremals for which second variation vanishes (at least for deformations representing dynamical symmetries) and thus providing space-time correlate for quantum criticality, the notion of number theoretic braid implied by the basic dynamics of Kähler action and crucial for precise construction of quantum TGD as almost-topological QFT, the construction of WCW metric and spinor structure in terms of second quantized induced spinor fields with modified Dirac action defined by Kähler action realizing the notion of finite measurement resolution and a connection with inclusions of hyper-finite factors of type  $II_1$  about which Clifford algebra of WCW represents an example.

The two most important number theoretic conjectures relate to the preferred extremals of Kähler action. The general idea is that classical dynamics for the preferred extremals of Kähler action should reduce to number theory: space-time surfaces should be either associative or co-associative in some sense.

Associativity (co-associativity) would be that tangent (normal) spaces of space-time surfaces associative (co-associative) in some sense and thus quaternionic (co-quaternionic). This can be formulated in two manners.

1. One can introduce octonionic tangent space basis by assigning to the "free" gamma matrices octonion basis or in terms of octonionic representation of the imbedding space gamma matrices possible in dimension  $D = 8$ .
2. Associativity (quaternionicity) would state that the projections of octonionic basic vectors or induced gamma matrices basis to the space-time surface generates associative (quaternionic) sub-algebra at each space-time point. Co-associativity is defined in analogous manner and can be expressed in terms of the components of second fundamental form.
3. For gamma matrix option induced rather than modified gamma matrices must be in question since modified gamma matrices can span lower than 4-dimensional space and are not parallel to the space-time surfaces as imbedding space vectors.

### 3. Infinite primes

The discovery of the hierarchy of infinite primes and their correspondence with a hierarchy defined by a repeatedly second quantized arithmetic quantum field theory gave a further boost for the speculations about TGD as a generalized number theory.

After the realization that infinite primes can be mapped to polynomials possibly representable as surfaces geometrically, it was clear how TGD might be formulated as a generalized number theory with infinite primes forming the bridge between classical and quantum such that real numbers, p-adic numbers, and various generalizations of p-adics emerge dynamically from algebraic physics as various completions of the algebraic extensions of rational (hyper-)quaternions and (hyper-)octonions. Complete algebraic, topological and dimensional democracy would characterize the theory.

What is especially interesting is that p-adic and real regions of the space-time surface might also emerge automatically as solutions of the field equations. In the space-time regions where the solutions of field equations give rise to in-admissible complex values of the imbedding space coordinates, p-adic solution can exist for some values of the p-adic prime. The characteristic non-determinism of the p-adic differential equations suggests strongly that p-adic regions correspond to 'mind stuff', the regions of space-time where cognitive representations reside. This interpretation implies that p-adic physics is physics of cognition. Since Nature is probably a brilliant simulator of Nature, the natural idea is to study the p-adic physics of the cognitive representations to derive information about the real physics. This view encouraged by TGD inspired theory of consciousness clarifies difficult interpretational issues and provides a clear interpretation for the predictions of p-adic physics.

### 1.1.6 Hierarchy of Planck constants and dark matter hierarchy

By quantum classical correspondence space-time sheets can be identified as quantum coherence regions. Hence the fact that they have all possible size scales more or less unavoidably implies that Planck constant must be quantized and have arbitrarily large values. If one accepts this then also the idea about dark matter as a macroscopic quantum phase characterized by an arbitrarily large value of Planck constant emerges naturally as does also the interpretation for the long ranged classical electro-weak and color fields predicted by TGD. Rather seldom the evolution of ideas follows simple linear logic, and this was the case also now. In any case, this vision represents the fifth, relatively new thread in the evolution of TGD and the ideas involved are still evolving.

#### Dark matter as large $\hbar$ phases

D. Da Rocha and Laurent Nottale [E29] have proposed that Schrödinger equation with Planck constant  $\hbar$  replaced with what might be called gravitational Planck constant  $\hbar_{gr} = \frac{GmM}{v_0}$  ( $\hbar = c = 1$ ).  $v_0$  is a velocity parameter having the value  $v_0 = 144.7 \pm .7$  km/s giving  $v_0/c = 4.6 \times 10^{-4}$ . This is rather near to the peak orbital velocity of stars in galactic halos. Also subharmonics and harmonics of  $v_0$  seem to appear. The support for the hypothesis coming from empirical data is impressive.

Nottale and Da Rocha believe that their Schrödinger equation results from a fractal hydrodynamics. Many-sheeted space-time however suggests that astrophysical systems are at some levels

of the hierarchy of space-time sheets macroscopic quantum systems. The space-time sheets in question would carry dark matter.

Nottale's hypothesis would predict a gigantic value of  $h_{gr}$ . Equivalence Principle and the independence of gravitational Compton length on mass  $m$  implies however that one can restrict the values of mass  $m$  to masses of microscopic objects so that  $h_{gr}$  would be much smaller. Large  $h_{gr}$  could provide a solution of the black hole collapse (IR catastrophe) problem encountered at the classical level. The resolution of the problem inspired by TGD inspired theory of living matter is that it is the dark matter at larger space-time sheets which is quantum coherent in the required time scale [K67].

It is natural to assign the values of Planck constants postulated by Nottale to the space-time sheets mediating gravitational interaction and identifiable as magnetic flux tubes (quanta) possibly carrying monopole flux and identifiable as remnants of cosmic string phase of primordial cosmology. The magnetic energy of these flux quanta would correspond to dark energy and magnetic tension would give rise to negative "pressure" forcing accelerate cosmological expansion. This leads to a rather detailed vision about the evolution of stars and galaxies identified as bubbles of ordinary and dark matter inside magnetic flux tubes identifiable as dark energy.

### Hierarchy of Planck constants from the anomalies of neuroscience and biology

The quantal ELF effects of ELF em fields on vertebrate brain have been known since seventies. ELF em fields at frequencies identifiable as cyclotron frequencies in magnetic field whose intensity is about 2/5 times that of Earth for biologically important ions have physiological effects and affect also behavior. What is intriguing that the effects are found only in vertebrates (to my best knowledge). The energies for the photons of ELF em fields are extremely low - about  $10^{-10}$  times lower than thermal energy at physiological temperatures- so that quantal effects are impossible in the framework of standard quantum theory. The values of Planck constant would be in these situations large but not gigantic.

This inspired the hypothesis that these photons correspond to so large a value of Planck constant that the energy of photons is above the thermal energy. The proposed interpretation was as dark photons and the general hypothesis was that dark matter corresponds to ordinary matter with non-standard value of Planck constant. If only particles with the same value of Planck constant can appear in the same vertex of Feynman diagram, the phases with different value of Planck constant are dark relative to each other. The phase transitions changing Planck constant can however make possible interactions between phases with different Planck constant but these interactions do not manifest themselves in particle physics. Also the interactions mediated by classical fields should be possible. Dark matter would not be so dark as we have used to believe.

The hypothesis  $h_{eff} = h_{gr}$  - at least for microscopic particles - implies that cyclotron energies of charged particles do not depend on the mass of the particle and their spectrum is thus universal although corresponding frequencies depend on mass. In bio-applications this spectrum would correspond to the energy spectrum of bio-photons assumed to result from dark photons by  $h_{eff}$  reducing phase transition and the energies of bio-photons would be in visible and UV range associated with the excitations of bio-molecules.

Also the anomalies of biology (see for instance [K54, K55, K88]) support the view that dark matter might be a key player in living matter.

### Does the hierarchy of Planck constants reduce to the vacuum degeneracy of Kähler action?

This starting point led gradually to the recent picture in which the hierarchy of Planck constants is postulated to come as integer multiples of the standard value of Planck constant. Given integer multiple  $\hbar = n\hbar_0$  of the ordinary Planck constant  $\hbar_0$  is assigned with a multiple singular covering of the imbedding space [K26]. One ends up to an identification of dark matter as phases with non-standard value of Planck constant having geometric interpretation in terms of these coverings providing generalized imbedding space with a book like structure with pages labelled by Planck constants or integers characterizing Planck constant. The phase transitions changing the value of Planck constant would correspond to leakage between different sectors of the extended imbedding

space. The question is whether these coverings must be postulated separately or whether they are only a convenient auxiliary tool.

The simplest option is that the hierarchy of coverings of imbedding space is only effective. Many-sheeted coverings of the imbedding space indeed emerge naturally in TGD framework. The huge vacuum degeneracy of Kähler action implies that the relationship between gradients of the imbedding space coordinates and canonical momentum currents is many-to-one: this was the very fact forcing to give up all the standard quantization recipes and leading to the idea about physics as geometry of the "world of classical worlds". If one allows space-time surfaces for which all sheets corresponding to the same values of the canonical momentum currents are present, one obtains effectively many-sheeted covering of the imbedding space and the contributions from sheets to the Kähler action are identical. If all sheets are treated effectively as one and the same sheet, the value of Planck constant is an integer multiple of the ordinary one. A natural boundary condition would be that at the ends of space-time at future and past boundaries of causal diamond containing the space-time surface, various branches co-incide. This would raise the ends of space-time surface in special physical role.

A more precise formulation is in terms of presence of large number of space-time sheets connecting given space-like 3-surfaces at the opposite boundaries of causal diamond. Quantum criticality presence of vanishing second variations of Kähler action and identified in terms of conformal invariance broken down to to sub-algebras of super-conformal algebras with conformal weights divisible by integer  $n$  is highly suggestive notion and would imply that  $n$  sheets of the effective covering are actually conformal equivalence classes of space-time sheets with same Kähler action and same values of conserved classical charges (see fig. <http://www.tgdtheory.fi/appfigures/planckhierarchy.jpg>, which is also in the appendix of this book).  $n$  would naturally correspond the value of  $h_{eff}$  and its factors negentropic entanglement with unit density matrix would be between the  $n$  sheets of two coverings of this kind. p-Adic prime would be largest prime power factor of  $n$ .

### Dark matter as a source of long ranged weak and color fields

Long ranged classical electro-weak and color gauge fields are unavoidable in TGD framework. The smallness of the parity breaking effects in hadronic, nuclear, and atomic length scales does not however seem to allow long ranged electro-weak gauge fields. The problem disappears if long range classical electro-weak gauge fields are identified as space-time correlates for massless gauge fields created by dark matter. Also scaled up variants of ordinary electro-weak particle spectra are possible. The identification explains chiral selection in living matter and unbroken  $U(2)_{ew}$  invariance and free color in bio length scales become characteristics of living matter and of bio-chemistry and bio-nuclear physics.

The recent view about the solutions of Kähler- Dirac action assumes that the modes have a well-defined em charge and this implies that localization of the modes to 2-D surfaces (right-handed neutrino is an exception). Classical  $W$  boson fields vanish at these surfaces and also classical  $Z^0$  field can vanish. The latter would guarantee the absence of large parity breaking effects above intermediate boson scale scaling like  $h_{eff}$ .

## 1.2 Bird's eye of view about the topics of the book

The topics of this book could be called fringe physics involving claimed phenomena which do not have explanation in terms of standard physics and are usually regarded as non-existing solely on this ground and by the fact that the proposed theories rather rarely satisfy the strict conceptual and technical standards of mathematical physics.

Many-sheeted space-time with p-adic length scale hierarchy, the predicted dark matter hierarchy with levels partially characterized by quantized dynamical Planck constant, and the prediction of long ranged color and weak forces, alone predict a vast variety of new physics effects. Zero energy ontology predicts that energy can have both signs. The dual view about time predicts that classical signals can also propagate in reversed time direction at negative energy space-time sheets and a highly attractive identification for negative energy signals would be as generalizations of phase conjugate laser beams. This vision leads to a coherent vision about metabolism, memory, and

biocontrol and it is natural to ask whether the reported anomalies might after all reflect genuinely new physics which is also behind the proposed phenomena explaining the mother of all anomalies, the behavior of living matter.

1. The first class of effects involves coin words like antigravity, strong gravity, and electrogravity. This motivates the discussion of possible anomalous effects related to long range weak fields and many-sheeted gravitation. The strange effects associated with rotating magnetic systems, such as the dependence of the direction of generated radial electric field and corresponding charge density on direction of rotation (large parity breaking) observed already by Faraday, spontaneous acceleration, over unity energy production, and generation of plasma phase, and magnetic flux walls, are reported repeatedly and TGD indeed leads to a many-sheeted model for this involving also the notions of magnetic body and dark matter.
2. Tesla has become a god like character in free energy circles. One basis of his experimental experience Tesla did not believe that Maxwell's theory was an exhaustive description of electromagnetism. He claimed that experimental findings related to pulsed systems require the assumption of what he called scalar waves not allowed by Maxwell's electrodynamics. TGD however allows scalar wave pulses propagating with light velocity. The dropping of particles to larger space-time sheets liberating metabolic energy, transformation of ordinary charged matter to dark matter and vice versa, dark photons, etc... might be needed to really explain Tesla's findings. Also phase conjugate, possibly dark, photons making possible communications with geometric past might be involved.
3. The reports about ufos represent a further application for TGD based view about Universe. The presence of infinite self hierarchy represented by dark matter hierarchy makes it almost obvious that higher civilizations are here, there, and everywhere, and that their relationship to us is like that of our brain to its neurons, so that the well-known Fermi paradox (Where are they all?) would disappear. Although the space travel as we understand it might be quite too primitive idea for the civilizations at higher levels of hierarchy one can still consider the possibility whether the ufos might be real objects and represent more advanced technology rather than plasmoid like life forms serving as mediums in telepathic communications.

### 1.3 Sources

The eight online books about TGD [K83, K62, K96, K72, K47, K95, K94, K70] and nine online books about TGD inspired theory of consciousness and quantum biology [K76, K13, K53, K11, K30, K38, K42, K69, K89] are warmly recommended for the reader willing to get overall view about what is involved.

My homepage (<http://www.tgdtheory.com/curri.html>) contains a lot of material about TGD. In particular, there is summary about TGD and its applications using CMAP representation serving also as a TGD glossary [L8, L9] (see <http://www.tgdtheory.fi/cmaphtml.html> and <http://www.tgdtheory.fi/tgdglossary.pdf>).

I have published articles about TGD and its applications to consciousness and living matter in *Journal of Non-Locality* (<http://journals.sfu.ca/jnonlocality/index.php/jnonlocality>) founded by Lian Sidorov and in *Prespacetime Journal* (<http://prespacetime.com>), *Journal of Consciousness Research and Exploration* (<https://www.createpace.com/4185546>), and *DNA Decipher Journal* (<http://dnadecipher.com>), all of them founded by Huping Hu. One can find the list about the articles published at <http://www.tgdtheory.com/curri.html>. I am grateful for these far-sighted people for providing a communication channel, whose importance one cannot overestimate.

### 1.4 The contents of the book

#### 1.4.1 Anomalies related to the classical $Z^0$ force and gravitation

TGD based concept of space-time predicts several new effects.

a) The dark matter associated with rotating macroscopic objects should generate  $Z^0$  magnetic fields and this suggests that the behavior of rotating objects should exhibit anomalies. A special signature of effects of this kind is parity breaking caused by the parity breaking couplings of the classical  $Z^0$  field to dark matter. The  $Z^0$  electric fields generated by astrophysical bodies are predicted to be completely negligible as compared to gravitational fields but the topological light rays carrying  $Z^0$  fields could induce interactions over astrophysical distances.  $Z^0$  fields in length scale below cell size are predicted to be quite strong as compared to gravitation.

b) The mere rotation of a 3-surface carrying magnetic or  $Z^0$  magnetic fields should induce electric or  $Z^0$  electric fields whose divergence gives rise to vacuum charge density. Charge conservation suggests that this gauge flux must flow to a second space-time sheet carrying opposite net charge.

c) In TGD the time orientation of given space-time sheet need not be the standard one and this allows the possibility of negative classical energies. If this kind of space-time sheets are created, energy production with apparent efficiency greater than unity becomes possible. At the space-time sheets with negative time orientations classical fields should propagate from future to past making in principle possible to see to the geometric future of, say, astrophysical objects. Amazingly, the highly science fictive notion of negative energy space-time sheet finds support from the basic classical physics. The total energy associated with the topological field quanta emitted by particle a condensed to larger space-time sheets is the natural geometric correlate of potential energy. Potential energy can be negative only if one allows also negative energy space-time sheets.

d) A further TGD based element is related to the fact that 3-surface can be regarded as a generalization of point like particle. This means that 3-surface behaves like single coherent whole: in particular, classical fields oscillating coherently in arbitrary long length scales are possible and can give rise to an apparent propagation of effects with infinite velocity. The notion of pair creation from vacuum generalizes. For instance, pairs of space-time sheets with vanishing total classical energy can be created from vacuum.

#### 1. *Some gravitational anomalies*

a) TGD predicts the possibility of anomalously large time dilation effects due to the warping of space-time surfaces, and the experimental findings of Russian physicist Chernobrov about anomalous changes in the rate of flow of time provide indirect support for this prediction.

b) There are quite puzzling observations related to the behavior of rotating stars. These observations are in a dramatic conflict with the standard wisdom about finite propagation velocity of signals and with the idea that classical fields propagate in future direction only. The possibility of space-time sheets with negative time orientation and classical fields propagating from geometric future to geometric past plus the possibility that 3-surfaces of even astrophysical size can behave like particle like objects, could explain these mysterious effects.

#### 2. *Anomalies related to $Z^0$ force in astrophysical length scales*

a) Allais observed that the oscillation plane of Foucault pendulum changes during solar eclipse. NASA performed the same experiment during 1999 eclipse but the processing of the data is still going on. The presence of moon could cause a modification of dark  $Z^0$  laser beams emitted by Sun as synchrotron radiation and modify the contribution of  $Z^0$  electric field to  $Z^0$  force experienced by dark matter component of the pendulum. The effect is predicted to be observed only in the shadow of Moon created by Sun. Allais has observed also 24 and 25 hour periodicities in the oscillation of Foucault pendulum can be understood in terms of Earth's modification and the lengthening of the period associated with the Moon's screening due to the rotational motion of Moon around Earth.

b) Shnoll has shown that the rate distributions for radio active decays and chemical and biochemical processes do not converge to single bell curve but to distributions which have several pronounced peaks. The shapes of the rate curves seem to be similar for widely different reactions (radio-active decays, chemical and biochemical processes) but they fluctuate with time and fluctuation periods correspond to various astrophysical periods: day, month, year,... These anomalies can be understood if astrophysical objects emit  $Z^0$  topological light rays interacting with ordinary matter (recall that already nuclei involve dark matter component).

c) p-Adic fractality predicts that dark  $Z^0$  force should become comparable with the gravitational force in cell length scale. Tests of the Newtonian form of gravitational force are recently carried out in length scales  $100 \mu\text{m}$ . There are anomalously large differences related to the measured values of gravitational constant using Cavendish type experiments or their variants. In the classical



Cavendish experiment  $Z^0$  force is effectively eliminated so that most of these discrepancies could be caused by the redistribution of the gravitational flux between space-time sheets.

### 1.4.2 The notion of free energy and many-sheeted space-time

In this chapter a general vision about new energy technologies provided by the new ontology forced by TGD is discussed, some evidence for the new ontology is considered, and models explaining some "free energy" anomalies are discussed.

There are close connections to the basic mechanisms of energy metabolism in living matter in TGD Universe and one cannot avoid even reference to TGD inspired quantum theory of consciousness. The point is that so called time mirror mechanism defines a mechanism of remote metabolism as sucking of energy from remote energy storage, a mechanism of memory as communications with geometric past, and mechanism of intentional action initiating neural activity in geometric past. At the level of technology time mirror mechanism would define a mechanism of energy transfer, communication, and remote quantum control.

#### 1. *The new ontology*

The ontology of TGD Universe involves several new elements. The notion of many-sheeted space-time means that each physical system corresponds to a space-time sheet, its own sub-universe in geometric sense, and glued to a larger space-time sheet and containing subsystems as smaller space-time sheets glued to it. Many-sheeted space-time leads to the notion of field body distinguishing between TGD and Maxwell's electrodynamics. One can assign to each physical system a field body (or magnetic body) and in case of living matter it acts as intentional agent using biological body as a sensory receptor and motor instrument.

Zero energy ontology states that any physical system has a vanishing net energy so that everything is creatable from vacuum. Zero energy states decompose into positive and negative energy parts. The possibility of negative energy signals is one important implication and a considerable modification of thermodynamics is forced by the fact that different signs of energy correspond to different arrows of geometric time.

Negative energy signals propagating to the geometric past inspire a new vision about communications, energy technology, and remote control. The implications are especially important for the understanding of living matter where both time directions manifest themselves. In neuroscience a radically new view about memory based on the notion of 4-D brain emerges.

The hierarchy of Planck constants implies a generalization of the notions of imbedding space and space-time and macroscopic quantum coherence in all length and time scales at high enough levels of dark matter hierarchy assigned to the hierarchy of Planck constant. The consequences of this hypothesis are powerful: entire cosmos should be in a well-defined sense a living system with dark matter representing higher level conscious entities.

The original motivation for the p-adic physics were the highly successful calculations of elementary particle masses based on p-adic thermodynamics and conformal invariance. The only sensible interpretation of p-adic physics seems to be as physics of cognition and intentionality meaning that cognition is present even at elementary particle level. This implies a profound generalization of space-time concept implying that cognition and intentionality are literally cosmic phenomena but having experimentally measurable correlates in real physics.

#### 2. *The new view about energy*

The basic idea is that quantum biology could teach us a lot about energy technology. The necessity to carry fuel is one of the drawback of standard energy technologies. Remote metabolism based on sucking of energy by sending negative energy signals to energy storage analogous to a population inverted laser defines what might be called quantum credit card. This is the basic metabolic mechanism of TGD inspired quantum biology. The mechanism could make sense also as an energy technology.

In biological systems the fuel serves as an energy storage and is recycled. Animal cells burn the fuel and plant cells reconstruct it using sunlight as an energy source. Similar recycling of the fuel could make it un-necessary to carry large amounts of fuel. The systems doing the recycling could be seen as primitive life forms and plasmoids are an excellent candidate in this respect. Fuel could be practically any quantum system with two or more states with different energies.

Large Planck constant phases would make it possible to communicate short wave length photons over long distances: say photons with energy of visible photon but having wavelength of EEG photon. This might help to achieve a lossless energy transfer. Topological light rays ("massless extremals") would be in a key role in making possible precisely targeted, dispersion-free and lossless energy and information transfer. They are ideal also for quantum control.

### 3. Evidence for the new ontology

There are surprisingly many well established anomalies supporting the new ontology and these anomalies have been a strong guiding line in attempts to construct a general theoretical framework.

a) There is a considerable support for the notion many-sheeted space-time quantified in terms of p-adic length scale hypothesis. One example is the radiation from interstellar dust having no generally accepted interpretation in terms of molecular transitions. The interpretation in terms of metabolic energy quanta liberated in dropping of electrons or protons to larger space-time sheets makes sense quantitatively.

b) The Bohr quantization of radii of planetary orbits and quantal effects of ELF em fields on vertebrate brain helped considerably to develop the ideas about the hierarchy of Planck constants. Later a lot of further anomalies have emerged supporting the quantization of Planck constant.

c) Living matter is a gigantic bundle of anomalies from the point of view of recent day physics and the notion of field body combined with p-adic length scale hypothesis allows to develop detailed models for how magnetic body controls biological body and receives sensory input from it. The notion of field body leads also to a concrete model for pre-biotic life based on the notion of plasmoid involving magnetic body controlling plasma phase. Recently a considerable empirical support for this notion has emerged.

### 4. Podkletnov- and Modanese-Podkletnov effects

The explanation of Modanese-Podkletnov effect shares many common elements with the model of Podkletnov effect and actually led to the correct track allowing to eliminate competing models.

The "dropping" of electrons to the space-time sheets of topological light rays emitted by a critical system would be the key mechanism besides rotation induced charging. During the discharge of the capacitor (Modanese-Podkletnov effect) this mechanism would induce the motion of test penduli. In the case of a super-conductor making repeatedly a transition to a non-super-conducting state (Podkletnov effect) this mechanism would induce the motion of air above super conductor and apparent loss of weight of test particles. Biefeld-Brown effect associated with lifters and corona wind can be explained by the same mechanism as Modanese-Podkletnov effect. Podkletnov effect is enhanced by the em and  $Z^0$  charging induced by rotation and thus involves also the em and  $Z^0$  variants of Searl effect.

### 5. Over unity effects

Over-unity effects are the basic claim of free energy research community. TGD indeed allows temporary over-unity effects: the basic mechanism is the dropping of particles on larger space-time sheets liberating zero point kinetic energy appearing as a basic metabolic mechanism in TGD inspired theory of living systems. This mechanism does not allow a perpetuum mobile: the particles must be kicked back to the smaller space-time sheets and in the ordinary living matter solar radiation takes care of this. There are also anomalies associated with the dissociation of water and hydrogen molecules. The hydrino atom concept of Mills is also closely related to these anomalies and TGD based justification for the notion is discussed in this chapter.

## 1.4.3 About strange effects related to rotating magnetic systems

In this chapter the anomalies claimed to be associated with rotating magnetic system are discussed in TGD based conceptual framework.

### 1. The anomalies associated with rotating magnetic systems

In the beginning of the year 2002 I learned about strange effects related to rotating magnetic systems, and the model for these effects has evolved (and is still evolving) gradually during the year 2002 via trial and error process. Several new physics effects seem to be involved.

a) The rotating magnetic system develops em and  $Z^0$  charges and experiences the classical em and  $Z^0$  electric forces created by Earth so that the effective weight is reduced or increases (depending on the direction of rotation) as much as 35 per cent. The charging is due to the flow of electrons and possibly also neutrinos from the rolling magnets to the surrounding air induced by the radial electric and  $Z^0$  electric fields generated by the Faraday effect inducing vacuum charge density (not possible in Maxwell's electrodynamics). The fact that critical frequencies are different for clockwise and counter clockwise spontaneous rotation implies that classical  $Z^0$  force and neutrino currents must be present.

b) The spontaneous accelerating rotation above critical frequency can be understood as being to a Lorentz torque acting on the radial Ohmic em and  $Z^0$  currents in rollers and roller ring. Above the critical frequency the Lorentz torque, which is proportional to rotation frequency, becomes larger than frictional torque, and spontaneous accelerating rotation becomes possible due to the positive feedback. Energetic constraints imply negative feed back and the modelling of this "back reaction" leads to a model of the system based on butterfly catastrophe in Thom's classification of elementary catastrophes and allowing also to understand the effect of the load. Rather precise estimates for the parameters result and allow to quantify the role of the classical  $Z^0$  force.

c) The radial ohmic current of electrons leaking from the atomic space-time sheets of rollers to the space-time sheet of environment explains the presence of plasma around the system. The ionization of the molecules is caused by the electrons from rollers gaining keV energy as they drop from atomic space-time sheets of rollers to the space-time sheets of the environment.

d) The zero point kinetic energy liberated in the dropping of electrons serves as the energy source making the system an energy source. For instance, the emitted photon carrying zero point kinetic energy can be absorbed by the atom in the uppermost layer. This allows also to transfer the angular momentum gained by the conduction electron current to the roller so that accelerated rotation results. A remote metabolism based on the emission of negative energy (phase conjugate) dark microwave photons absorbed by the dropping electrons is the simplest mechanism providing energy for the magnetic walls and for electrons in collective cyclotron states. Also the remote transfer of angular momentum and remote spontaneous magnetization can be considered.

e) The latest progress relates to the understanding of the role of material decomposition of the Searl device (layered Nd-nylon-Fe-Ti structure. The model the current flow equilibrium for the 4-layered cylindrical structure gives detailed quantitative picture about how charge accumulates in the interiors of layers and to the layer-layer boundaries emerges. The key finding is that the small electrical conductivity of air requires in the flow equilibrium that the electric field at the outer boundary of titanium layer is amplified by a factor of order  $10^8$  to a field which is by a factor of order  $10^3$  higher than the critical field inducing di-electric breakdown in air so that the simple model fails. The huge increase of the electric field requires an accumulation of positive charge at Ti-air boundary and explains why the air must be ionized but not its mechanism based on the dropping of electrons to larger space-time sheets.

The four-layered structure is used also for the stator: this can be understood if the magnetic field of stator also rotates as is suggested by the fact that its return flux goes through the rollers. The rotation of the stator magnetic field leads to a simple model for the classical behavior of the roller system as a dynamical equilibrium in which the electrostatic torque generated by the rotation of the stator and roller charge distributions induced by Lorentz torque on conduction electrons vanishes as rollers rotate with the same velocity as the charge distribution in the stator.

f) The formation of the magnetic walls means the emergence of long length scale fluctuations with coherence length much longer than the size of the system. Hence a quantum critical phenomenon seems to be in question and this could explain why the replication of the experimental findings has turned out to be so difficult. There are indeed many conditions to be satisfied. The distance between magnetic walls must correspond to the radius of the stator in resonance. This length scale also corresponds to the wavelength of dark microwave photons emitted in cyclotron transitions and the energy of these photons must also correspond to a zero point kinetic energy liberated as electron drops to larger space-time sheet. The requirement that liberated zero point kinetic energy in the dropping of electron corresponds to the ionization energy of titanium atom for  $n = 3$  valence electron makes also the phenomenon quantum critical.

## 2. Other anomalies involving Searl effect

The functioning of Tewari's space-energy generator and N-machine of DePalma can be under-

stood as being based on same principles as the functioning of Searl device. Also other anomalies associated with spinning systems could be understood along similar lines so that the model for Searl device seems to have caught something essential.

#### 1.4.4 Did Tesla discover the mechanism changing the arrow of time?

Negative energy topological light (phase conjugate laser waves) rays provide the fundamental control mechanism in the TGD based model of living matter and appears in practically every mechanism of consciousness as a basic step. This is however not yet the whole story. One should also identify mechanisms allowing to control the generation of the negative energy topological light rays: direct transformation of p-adic MEs to negative energy MEs is probably not enough.

The solution to the problem came from an quite unexpected direction. It was the attempt to understand the physics behind the visions of Tesla which led to an identification of a very general mechanism of this kind. I had already earlier discovered that Tesla's scalar wave pulses can be realized as solutions of field equations in TGD framework but the physical interpretation had remained obscure.

In this chapter the general vision allowing to understand the findings of Tesla and others relating to binary coils and Tesla transformers are discussed. The basic idea is that the rapid acceleration of charges induced by scalar wave pulses induces generation of negative energy topological light rays as time reversed counterpart of brehmstrahlung. The solutions of field equations describing Tesla's scalar wave pulses are discussed first. Various strange findings of Tesla are discussed at a general level using the resulting over all picture. The chapter ends with the model for the causal anomalies observed in the tunnelling of photons through potential barriers.

#### 1.4.5 About Concrete Realization of Remote Metabolism

The idea of "remote metabolism" (or quantum credit card, as I have also called it) emerged more than a decade ago - and zero energy ontology (ZEO) provides the justification for it. The idea is that the system needing energy sends negative energy to a system able to receive the negative energy and make a transition to a lower energy state. This kind of mechanism would be ideal for biology, where rapid reactions to a changing environment are essential for survival. Originally this article was intended to summarize a more detailed model of remote metabolism but the article expanded to a considerably more detailed view about TGD inspired biology than the earlier vision.

It is shown that the basic notions of the theory of Ling about cell metabolism inspired by various anomalies have natural counterparts in TGD based model relying on the notion of magnetic body. Remote metabolism can be considered as a universal metabolic mechanism with magnetic body of ATP, or system containing it, carrying the metabolic energy required by the biological user. In particular, the role of ATP is discussed in Ling's theory and from the point of view of TGD-inspired theory of consciousness.

It is easy to imagine new technologies relying on negative energy signals propagating to the geometric past and ZEO justifies these speculations. Remote metabolism could make possible a new kind of energy technology. The discoveries of Tesla made more than a century ago plus various free energy anomalies provide excellent material for developing these ideas, and one ends up with a concrete proposal for how dark photons and dark matter could be produced in capacitor-like systems analogous to cell membranes and acting as Josephson junctions and how energy could be extracted from "large" magnetic bodies.

The model identifies Josephson frequency with the subharmonic of the frequency characterizing the periodicity of a periodic voltage perturbation assumed to correspond to cyclotron frequency in biological applications. Together with quantization conditions for charge and effective Planck constant it leads to precise quantitative predictions for capacitor-like systems acting as dark capacitors. Also a relationship between the magnetic field at the magnetic body of the system and the voltage of the capacitor-like Josephson junction emerges.

The predictions allow new quantitative insights about biological evolution as emergence of Josephson junctions realized as capacitor-like systems both at the level of cell, DNA and proteins, and brain.  $h_{eff}$  can be related to Josephson frequency and cyclotron frequency and thus to measurable parameters.  $h_{eff}$  serves as a kind of intelligence quotient and its maximization requires the maximization of both the voltage and area of the membrane-like capacitor system involved.

This is what has happened during evolution. Indeed, the internal cell membranes, cortical layers and DNA double strand in chromosomes are strongly folded, and the value of membrane electric field is roughly twice the value of the electric field for which di-electric breakdown occurs in air. Even 40 Hz thalamocortical resonance frequency can be understood in the framework of the model.

The claimed properties of Tesla's "cold electricity" strongly suggest interpretation in terms of dark matter in TGD sense. This leads to a proposal that a transition to dark phase occurs when the value of voltage equals the rest mass of charged particle involved. This criterion generalizes to the case of cell membrane and relates the values of  $h_{eff}$ , p-adic prime  $p$ , and threshold potential for various charged particles to each other. The idea that nerve pulse corresponds to the breakdown of super-conductivity as a transition from dark to ordinary phase receives additional support. The resulting picture conforms surprisingly well with the earlier speculations involving dark matter and p-adically scaled variants of weak and color interactions in biologically relevant length scales. An extremely simple mechanism producing ATP involving only the kicking of two protonic Cooper pairs through the cell membrane by Josephson photon as a basic step is proposed. Also the proposal that neutrino Cooper pairs could be highly relevant not only for cognition and but also metabolism finds support.

#### 1.4.6 Summary of TGD Inspired Ideas about Free Energy

A summary of the work done in an attempt to understand free energy phenomena in TGD framework is provided: this includes some slightly updated chapters from the book "p-Adic length scale hypothesis and dark matter hierarchy". Some new ideas and devices related to free energy are discussed.

The ZPE approach is compared with the TGD approach identifying dark matter as a hierarchy of phases of ordinary matter characterized by non-standard value of Planck constant  $h_{eff} = nh$ . The general ideas behind anomalous hydrolysis of water are introduced, and a TGD inspired model for Brown's gas explaining its anomalous properties is formulated. This inspires a vision about how metabolism in living matter could utilize the mechanisms explaining the behavior of Brown's gas.

#### 1.4.7 Ufos, aliens, and the new physics

The TGD based view about space-time, time and consciousness allows also to develop ideas about UFOs and aliens, in particular about possible manners by which highly developed civilizations could receive information about remote parts of the Universe and to get contact with other civilizations.

Time mirror mechanism is a basic mechanism in TGD inspired theory of consciousness and it has also technological applications including instantaneous remote sensing of geometric past, communications with geometric past, and instantaneous remote utilization of energy, and perhaps even remote induction of simple life forms, about which simplest are perhaps plasmoids. The intelligent looking light balls reported repeatedly by UFO experiencers are indeed identifiable as plasmoids and quite recent experimental findings demonstrate that plasmoids satisfy the basic criteria justifying their identification as simple life forms.

The resulting vision about highly developed life forms and about how they could study the Cosmos allows to resolve Fermi paradox summarized by the simple question "Where are they all?", and reflecting in excellent manner our misguided view about life, consciousness, and physics.

TGD suggests also a mechanism making possible to reduce gravitational and inertial masses of space-ships so that they would behave like very light system as observations indeed suggest. Plasmoids could be living space-ships able to draw their energy from environment by the time mirror mechanism. It however seems that the highly developed civilizations would probably not see the trouble to travel to distant galaxies since it is unnecessary, and the finiteness of light velocity in any case would pose very strong limitations on what they could achieve in this manner.

Chilbolton and Crabwood crop circles can be interpreted as messages telling basic facts about the civilization responsible for their construction. Chilbolton message is constructed using the same format as Arecibo message and tells that both Earth, Mars, and Jupiter are colonized. These crop circles suggest strongly the existence of intra-terrestrial life and this inspired a model for pre-biotic evolution allowing also a model for the evolution of genetic code. The highly advanced civilization could be identified as either intelligent intra-terrestrials or as ourselves in the geometric

future using a technology based on time mirror mechanism to construct crop circles and using less intelligent intra-terrestrial plasmoids to construct the crop circles. Sun is depicted to have a smaller size as in Arecibo message, and Crabwood message came one year and one day after the Chilbolton message: these hints allow to make estimate about the temporal distance of this civilization of the geometric future from us.

The "sacred geometry" of crop circles involving ratios of simple rational numbers, simple algebraic numbers (in particular Golden Mean), and  $\pi$ , could be an attempt to tell us about the crucial importance of rational numbers and finite-dimensional extensions of p-adic numbers for cognition. If entanglement probabilities belong to an extension of rationals defining a finite-dimensional extension of p-adic numbers, one can assign to entanglement a positive information measure as a number theoretic modification of Shannon's entropy, and the interpretation as bound state entanglement crucial for macro-temporal quantum coherence is possible.



## Chapter 2

# Anomalies Related to the Classical $Z^0$ Force and Gravitation

### 2.1 Introduction

The topic of this chapter are new physics effects related to long ranged  $Z^0$  force, more generally weak forces, and gravitation in TGD Universe. Before summarizing these effects it is useful to sum up the basic interpretation of long ranged weak fields as space-time correlates of dark matter.

#### 2.1.1 TGD based view about dark matter

TGD suggests an explanation of dark matter as a macroscopically quantum coherent phase residing at larger space-time sheets [K21] .

1. TGD suggests that  $\hbar$  is dynamical and possesses a spectrum expressible as integer multiples of the ordinary Planck constant. For large values of  $\hbar$  macroscopic quantum phases are possible. The criterion for transition to large  $\hbar$  phase is the failure of perturbative expansion so that Mother Nature takes care of the problems of theoretician. A good guess is that the criticality condition reads as  $Q_1 Q_2 \alpha \simeq 1$  where  $Q_i$  are gauge charges and  $\alpha$  gauge coupling strength. This leads to universal properties of the large  $\hbar$  phase. For instance,  $\hbar$  is scaled in the transition to dark phase by a harmonic or subharmonic of parameter  $1/v_0 \simeq 2^{11}$  which is essentially the ratio of  $CP_2$  length scale and Planck length [K67, K21] . The criticality condition can be applied also to dark matter itself and entire hierarchy of dark matters is predicted corresponding to the spectrum of values of  $\hbar$ .
2. An infinite hierarchy of dark matters is predicted [K26] . Direct interactions occur only between the particles characterized by integers having common p-adic prime factors characterizing the p-adic length scales of bosons exchanged in the interaction. The algebraic extensions of p-adic numbers define an additional hierarchy. Also the notion of darkness must be refined by attributes partial and relative.
3. From the point of view of nuclear physics application of this hypothesis is to QCD. The prediction is that the electromagnetic Compton sizes of dark quarks are scaled from  $L_e(107)$  to about  $2^{11} L_e(107) = L_e(129) = 2L_e(127)$ , which is larger than the p-adic electromagnetic size of electron! The classical scattering cross sections are not changed but changes the geometric sizes of dark quarks, hadrons, and nuclei. The original hypothesis that ordinary valence quarks are dark whereas sea quarks correspond to ordinary value of  $\hbar$  is taken as a starting point. In accordance with the earlier model, nucleons in atomic nuclei are assumed to be accompanied by color bonds connecting exotic quark and anti-quark characterized p-adic length scale  $L_e(127)$  with ordinary value of  $\hbar$  and having thus scaled down mass of order MeV. The strong binding would be due the color bonds having exotic quark and anti-quark at their ends.



4. Quantum classical correspondence suggests that classical long ranged electro-weak gauge fields serve as classical space-time correlates for dark electro-weak gauge bosons, which are massless below the appropriate weak length scale  $L_w$ . This hypothesis could explain the special properties of bio-matter, in particular the chiral selection as resulting from the coupling to dark  $Z^0$  quanta. Long range weak forces present in TGD counterpart of Higgs=0 phase should allow to understand the differences between biochemistry and the chemistry of dead matter.
5. For ordinary condensed matter quarks and leptons  $Z^0$  charge are screened in electro-weak length scale whereas in dark matter  $k = 89$  electro-weak space-time sheet have suffered a phase transition to a p-adic topology with a larger value of  $k$ . Gaussian Mersennes, in particular those associated with  $k = 113, 151, 157, 163, 167$  are excellent candidates in this respect. The particles of this exotic phase of matter would have complex conformal weights closely related to the zeros of Riemann Zeta. The simplest possibility is that they correspond to a single non-trivial zero of Zeta and there is infinite hierarchy of particles of this kind.

In dark matter phase weak gauge fluxes could be feeded to say  $k = k_Z = 169$  space-time sheet corresponding to neutrino Compton length and having size of cell. For this scenario to make sense it is essential that p-adic thermodynamics predicts for dark quarks and leptons essentially the same masses as for their ordinary counterparts [K41] .

### 2.1.2 New Physics effects related to the new space-time concept

TGD based concept of space-time predicts several new effects.

1. The dark matter associated with rotating macroscopic objects should generate  $Z^0$  magnetic fields and this suggests that the behavior of rotating objects should exhibit anomalies. A special signature of effects of this kind is parity breaking caused by the parity breaking couplings of the classical  $Z^0$  field to dark matter. The  $Z^0$  electric fields generated by astrophysical bodies are predicted to be completely negligible as compared to gravitational fields but the topological light rays carrying  $Z^0$  fields could induce interactions over astrophysical distances.  $Z^0$  fields in length scale below cell size are predicted to be quite strong as compared to gravitation.
2. The mere rotation of a 3-surface carrying magnetic or  $Z^0$  magnetic fields should induce electric or  $Z^0$  electric fields whose divergence gives rise to vacuum charge density. Charge conservation suggests that this gauge flux must flow to a second space-time sheet carrying opposite net charge.
3. In TGD the time orientation of given space-time sheet need not be the standard one and this allows the possibility of negative classical energies. If this kind of space-time sheets are created, energy production with apparent efficiency greater than unity becomes possible by time mirror mechanism [K78] . At the space-time sheets with negative time orientations classical fields should propagate from future to past making in principle possible to see to the geometric future of, say, astrophysical objects. Amazingly, the highly science fictive notion of negative energy space-time sheet finds support from the basic classical physics. The total energy associated with the topological field quanta emitted by particle and condensed to larger space-time sheets is the natural geometric correlate of potential energy. Potential energy can be negative only if one allows also negative energy space-time sheets.
4. A further TGD based element is related to the fact that 3-surface can be regarded as a generalization of a point like particle. This means that 3-surface behaves like single coherent whole: in particular, classical fields oscillating coherently in arbitrary long length scales are possible and can give rise to an apparent propagation of effects with infinite velocity. The notion of pair creation from vacuum generalizes. For instance, pairs of space-time sheets with vanishing total classical energy can be created from vacuum.

### 2.1.3 Some gravitational anomalies

1. TGD predicts the possibility of anomalously large time dilation effects due to the warping of space-time surfaces, and the experimental findings of Russian physicist Chernobrov about anomalous changes in the rate of flow of time [J12, J26] provide indirect support for this prediction.
2. There are quite puzzling observations related to the behavior of rotating stars [H38]. These observations are in a dramatic conflict with the standard wisdom about finite propagation velocity of signals and with the idea that classical fields propagate in future direction only. The possibility of space-time sheets with negative time orientation and classical fields propagating from geometric future to geometric past plus the possibility that 3-surfaces of even astrophysical size can behave like particle like objects, could explain these mysterious effects.

### 2.1.4 Anomalies related to $Z^0$ force in astrophysical length scales

Allais [E4, E22, E10, E11] observed that the oscillation plane of paraconic pendulum changes during solar eclipse. NASA performed the same experiment during 1999 eclipse but the processing of the data is still going on. The presence of moon could cause a modification of dark  $Z^0$  laser beams emitted by Sun as synchrotron radiation and modify the contribution of  $Z^0$  electric field to  $Z^0$  force experienced by dark matter component of the pendulum. The effect is predicted to be observed only in the shadow of Moon created by Sun. Allais has observed also 24 and 25 hour periodicities in the oscillation of Foucault pendulum can be understood in terms of Earth's modification and the lengthening of the period associated with the Moon's screening due to the rotational motion of Moon around Earth.

Shnoll [E20], [E20] has demonstrated that the rate distributions for radio active decays and chemical and biochemical processes do not converge to single bell curve as suggested by quantum randomness plus standard model but to distributions which have several pronounced peaks. The shapes of the rate curves seem to be similar for widely different reactions (radio-active decays, chemical and biochemical processes) but they fluctuate with time and fluctuation periods correspond to various astrophysical periods: day, month, year,... These anomalies can be also understood if astrophysical objects emit  $Z^0$  topological light rays interacting with ordinary matter (recall that already nuclei involve dark matter component).

p-Adic fractality predicts that dark  $Z^0$  force should become comparable with the gravitational force in cell length scale. Tests of the Newtonian form of gravitational force are recently carried out in length scales 100  $\mu\text{m}$ . There are anomalously large differences related to the measured values of gravitational constant using Cavendish type experiments or their variants. In the classical Cavendish experiment  $Z^0$  force is effectively eliminated so that most of these discrepancies could be caused by the redistribution of the gravitational flux between space-time sheets.

### 2.1.5 Anomalies related to rotating systems

If ordinary condensed matter involves a dark matter component generating long range  $Z^0$  fields, one expects that rotating systems generate  $Z^0$  magnetic fields. Spinning systems represent a spectrum of anomalies involving parity breaking. Hence the natural guess is that long ranged weak magnetic fields might be an essential aspect of the phenomenon. Rotating magnetic systems (Searl device) [H49], the N-machine of DePalma [H20] and the space-energy generator of [H6] [H6], Podkletnov effect [H44], and Modanese-Podkletnov effect [H43] represent examples about situations in which long range  $Z^0$  forces seem to be of importance. Since also other key mechanisms are involved, the discussion of these effects is left to the chapter "The Notion of Free Energy and Many-Sheeted Space-Time Concept" [K78].

I have emphasized that this and the two next chapters reflect the development of ideas and are a collection of pages of a lab notebook rather than a final summary. After the revolution induced by the ideas about dark matter and interpretation of long ranged electro-weak and color gauge fields a dramatic convergence has however occurred: the latest updating reduced the number of pages roughly by a factor of two and most alternative new physics explanations for various effects could be dropped from consideration. To my humble opinion, also the continual cumulation of anomalies understood in TGD framework gives convincing support for the TGD view. In view of the potential

technological implications it is highly regrettable that the academic community has missed the boat so completely. There is however some light at the end of tunnel. The number of people working with competing theories of quantum gravitation and admitting that these approaches are in grave difficulties is steadily increasing.

The appendix of the book gives a summary about basic concepts of TGD with illustrations. There are concept maps about topics related to the contents of the chapter prepared using CMAP realized as html files. Links to all CMAP files can be found at <http://www.tgdtheory.fi/cmaphtml.html> [L8]. Pdf representation of same files serving as a kind of glossary can be found at <http://www.tgdtheory.fi/tgdglossary.pdf> [L9]. The topics relevant to this chapter are given by the following list.

- Geometrization of fields [L16]
- Classical TGD [L15]
- Manysheeted space-time [L20]
- Two models for cell membrane [L28]

## 2.2 The new view about inertial and gravitational energy

TGD predicts the possibility of negative energy space-time sheets and phase conjugate photons can be identified as negative energy photons. If photons with negative energies are allowed, it is difficult to deny the possibility of fermions with negative energies. The possibility of having both signs of energy suggests an elegant solution to the problem of matter-antimatter asymmetry and a powerful new energy technology.

1. The standard second quantization of Dirac spinors postulates that ground state is annihilated by annihilation operators for fermions and anti-fermions. One can construct explicitly the state annihilated by annihilation operators. Suppose that there is state which is not annihilated by any annihilation operator and apply the product of all annihilation operators to this state. Electrons and positrons represent holes in this sea and are created by applying creation operators. The states have positive energy with respect to the ground state. The aesthetic problem of this quantization is that ground state has an infinitely high negative energy.
2. In TGD framework one could change the role of creation and annihilation operators so that the ground state would be obtained by applying the product of all creation operators to vacuum. This state would have infinite positive energy. Fermions and anti-fermions would be holes in Dirac sea of positive energy and behave as negative energy quanta. One might expect that these two quantizations correspond to two different time orientations for the space-time surface.

### 2.2.1 Two manners to circumvent the infinite vacuum energy

The infinite vacuum energy is definitely something very unsatisfactory, and one should overcome this problem somehow. The most elegant and predictive variant of TGD inspired cosmology assumes that the net energy of the Universe vanishes so that the universe could have been created intentionally from vacuum (and be created again and again in each quantum jump). The vanishing of the total energy follows automatically if one poses the condition that the energy flow through the light cone boundary ( $H = M_+^4 \times CP_2$ ) vanishes. This requires that also fermionic vacuum energies cancel each other. There are two manners to achieve the cancellation.

1. If positive and negative energy space-time sheets are always created in a pairwise manner their vacuum energies could compensate each other, at least so if some additional conditions are satisfied. The success of elementary particle physics requires that this mechanism is at work in elementary particle length scales.

2. Vacuum energies could also cancel each other for each space-time sheet separately. This is achieved if the roles of creation and annihilation operators for either fermions or anti-fermions are exchanged. This implies automatically matter antimatter asymmetry since either fermions or anti-fermions would have negative energies. This option could be realized in long length scales and explain the absence of antimatter from the Universe as absence of positive energy antimatter. It would thus seem that all four ground states are in principle possible and that the ground state characterizes the phase of matter.

### 2.2.2 Zero energy vacuum is matter-antimatter asymmetric

Consider now in more detail the latter option 2) assuming for definiteness that it is anti-fermions for which the roles of creation and annihilation operators are exchanged. The ground state is obtained by applying the product of all fermion annihilation operators and anti-fermion creation operators to vacuum. Fermions represent holes in a completely filled negative energy Dirac sea and have positive energy. Anti-fermions represent holes in positive energy Dirac sea and have thus negative energy. In this ground state annihilation of photon pair is possible only to a fermion with positive and anti-fermion with negative energy.

Obviously the state is matter-antimatter asymmetric since anti-fermions cannot appear as positive energy holes. Negative energy antimatter could be present but could have remained invisible. For instance, Pauli Exclusion Principle would make the scattering of negative energy anti-fermions impossible in the case that there are not sufficiently many holes in the sea. The same occurs for condensed matter electrons below the surface of the Fermi sphere. Even in the case that negative energy anti-fermions are present abundantly, they might have escaped detection. Due to the prevailing dogmas, no-one has tried to detect signatures for the scattering of negative energy anti-fermions or two photon annihilation to a pair of positive energy fermion and negative energy anti-fermion.

### 2.2.3 Creation of matter from vacuum by annihilation of laser waves and their phase conjugates?

The possibility of negative energy anti-fermions suggests a new energy technology. Photons and their phase conjugates with opposite energies could only annihilate to a pair of positive energy fermion and negative energy anti-fermion. Vacuum could effectively serve as an unlimited source of positive energy and make creation of matter from nothing literally possible. The idea could be tested by allowing laser beams and their phase conjugates to interact and by looking whether fermions pop out via two-photon annihilation. Fermion-anti-fermion pairs with arbitrarily large fermion masses could be generated by utilizing photons of arbitrarily low energy. The energies of the final state fermion is completely fixed from conservation laws so that it should be relatively easy to check whether the process really occurs. Generalized Feynman rules predict the cross section for the process and it should behave as  $\sigma \propto \alpha^2/m^2$ , where  $m$  is the mass of the fermion so that annihilation to electrons is the best candidate for study. Bio-systems might have already invented intentional generation of matter in this manner. Certainly the possible new energy technology should be applied with some caution in order to not to build a new quasar!

### 2.2.4 Re-interpretation of TGD inspired cosmology

The proposed hypothesis challenges the basic interpretation of the TGD based cosmology [K17, K68] is derived from the consistency with General Relativity. The basic interpretational problem of TGD inspired cosmology has been that Robertson-Walker cosmologies represent vacuum extremals of the Kähler action. Einstein's equations are used to define the energy density of the cosmology. This is admittedly somewhat ad hoc procedure but forced by the Equivalence Principle and positivity of inertial masses.

The possibility of negative inertial masses leads to a profoundly new kind of interpretation of cosmology based on the hypothesis that gravitational mass is the absolute value of the inertial mass.

1. Vacuum property of R-W cosmologies means that negative and positive inertial energy densities cancel each other in the cosmological length scales. Gravitational mass represents the

absolute value of the inertial mass so that Einstein tensor corresponds to the difference of the positive energy momentum current associated with matter and the negative energy momentum current antimatter (in the phase in which anti-fermions have negative energies). These currents are indeed uniquely defined in TGD Universe. The basic equations of the standard cosmology survive as such. If gravitational mass had the sign of the inertial mass, there would be a repulsion between matter and antimatter and the basic equations for cosmology would be altered dramatically: this looks implausible.

2. The fact that Einstein tensor is a tensor quantity whereas inertial mass density is a component of a vector field, favors strongly the new interpretation. The strong non-conservation of gravitational mass during early cosmology is not anymore inconsistent with Poincare invariance. Although the explanation for the non-conservation of the inertial mass in terms of a mass transfer between different space-time sheet becomes obsolete, the models for asymptotic cosmology and asymptotic evolution of star still make sense. The interpretation in terms of the conservation of gravitational mass resulting from the separate conservation of matter and antimatter energy densities since the annihilation of matter and antimatter and the reverse of this process do not occur appreciably anymore.
3. The mysterious vacuum extremals quite generally represent matter-antimatter symmetric states whereas non-vacuum extremals are by definition matter-antimatter asymmetric with the density of Kähler field energy identifiable as the net inertial energy density. This gives very strong grasp to the interpretation and technological application of the theory. In particular, highly curved vacuum extremals represent high energy densities of matter and antimatter, and the generation of this kind of space-time sheets followed by a generation of Kähler fields represent a creation of matter and antimatter from vacuum followed by the emission of particles or anti particles inducing the Kähler field. This would make possible a genuine engineering of the Universe.

The new view changes dramatically the interpretation of the early periods of cosmology although the basic equations for the density of gravitational mass are not changed.

1. Since cosmic strings are not vacuum extremals, they could represent a phase in which fermions and positrons have the same sign of energy, that is the phase of standard quantum field theories. The creation of the Universe from vacuum would mean generation of cosmic strings of opposite time orientations from vacuum during the first moments of cosmology. I have used the notion of "wormhole magnetic field" about pairs of space-time sheets carrying magnetic fields in opposite directions and having opposite time orientations [K87] . This terminology would be appropriate also now.
2. The topological condensation of cosmic strings to the background space-time sheets would induce a phase transition in which positive energy antimatter falls into negative energy states by emitting the difference energy as ordinary particles of positive or negative energy depending on the sign of time orientation. This process would replace the decay of the ends of split cosmic strings to elementary particles as a source of ordinary matter. Since Kähler magnetic flux is conserved in the process of thickening of the flux tubes, the magnetic energy density per unit length for topologically condensed cosmic strings decreases like  $1/S$  ( $S$  is the area of cross section) in the process, and they become gradually magnetic or  $Z^0$  magnetic flux tubes serving as templates for various structures. The emitted particles topologically condense at the background space-time and possess vanishing average inertial energy density in the length scales where cosmology applies.

Critical cosmology naturally represents this phase transition, and the breaking of Lorentz symmetry can be interpreted as being caused by the seed of the phase transition located at  $r = 0$ . With the conventional interpretation for the Einstein tensor, the recent cosmology of course poses strong lower bounds on the sizes of these regions but with the new interpretation the separation of matter and antimatter corresponds to the breaking of the Cosmological Principle (Lorentz invariance) due to the presence of non-vanishing Kähler fields.

3. The obvious question is whether there is some scale in which the induced Kähler fields vanish or possibly an entire hierarchy of these scales corresponding to p-adic length scale hierarchy.

The model for large voids involves a "big" cosmic string at the center of the void carrying a non-vanishing and very high density of Kähler magnetic energy and Kähler charge whereas the cosmic strings at the boundaries of void would carry opposite Kähler charge. Could these two kinds of cosmic strings represent remnants of a primordial pair of cosmic strings with opposite time orientation? If this were the case, there would be a genuine separation of matter and antimatter in the scale of large voids.

4. The option for which gravitational masses have both signs, looks at first attractive because the gravitational repulsion between particles having gravitational masses of opposite sign could automatically lead to the separation of matter and antimatter containing regions. On the other hand, an antiparticle surrounded by matter would experience vanishing average acceleration so that the vanishing of energy density could occur in relatively short length scales.

One might even try to explain the observed acceleration of cosmic expansion in terms of this repulsion. p-Adic fractality however suggests an explanation as an apparent acceleration due to the fact that the average density of gravitational mass at larger space-time sheets representing longer p-adic length scales is lower, and the expansion occurs faster due to the weakening of the gravitational force. The notion of fractal energy density is somewhat questionable for a conserved inertial energy density in the presence of isotropy but makes sense for the density of the gravitational energy.

## 2.3 Some gravitational anomalies

In this section some exotic gravitational effects predicted by TGD are discussed. An infinite family of warped imbeddings of say Schwarzschild metric predicts the possibility of anomalous time dilation much larger than ordinary gravitational time dilation. There is indeed evidence for this kind of phenomenon [J12]. Second exotic effect would be antigravity effects due to the redistribution of the gravitational flux feeded by system to larger space-time sheets. A third dramatic effect would be signals propagating in the direction of geometric past as negative energy signals. There is empirical evidence also for this effect [J23].

### 2.3.1 Anomalous time dilation effects due to warping as basic distinction between TGD and GRT

TGD predicts the possibility of large anomalous time dilation effects due to the warping of space-time surfaces, and the experimental findings of Russian physicist Chernobrov about anomalous changes in the rate of flow of time [J12, J26] provide indirect support for this prediction.

#### Anomalous time dilation effect due to the warping

Consider first the ordinary gravitational time dilation predicted by GRT. For simplicity consider a stationary spherically symmetric metric  $ds^2 = g_{tt}dt^2 - g_{rr}dr^2 - r^2d\Omega^2$  in spherical coordinates. The time dilation is characterized by the difference  $\Delta = \sqrt{g_{tt}} - 1$ . In the weak field approximation one has  $g_{tt} = 1 + 2\Phi_{gr}$ , where  $\Phi_{gr}$  is gravitational potential. The ordinary time dilation is given by  $\Delta = \sqrt{g_{tt}} - 1 \simeq 2\Phi_{gr}$ . At the Earth's surface the gravitational potential of the Earth is about  $\Phi_{gr} = GM/R_E \simeq 10^{-9}$ .

Consider next the situation for space-time surfaces. There exists an infinite number of warped imbeddings of  $M^4$  to  $M^4 \times CP_2$  given by  $s^k = s^k(m^0)$ , which are metrically equivalent with the canonical imbedding with  $CP_2$  coordinates constant. New  $M^4$  time coordinate is related by a diffeomorphism to the standard one. By restricting the imbedding to  $M^4 \times S^1$ , where  $S^1$  a geodesic circle with radius  $R/2$  (using the chosen convention for the definition  $CP_2$  radius), the time component of the induced metric is  $g_{m^0m^0} = 1 - R^2\omega^2/4$ . The identification of  $M^4$  coordinates as the preferred natural standard coordinate frame allows to overcome the difficulties related to the identification of the preferred time coordinate in general relativity in the case the metric does not approach asymptotically flat metric. For this choice an anomalous time dilation  $\sqrt{1 - R^2\omega^2/4}$  due to the warping results even when gravitational fields are absent. Moreover, the dilation can be large.

The study of the imbeddings of Schwarzschild metric as vacuum extremals [K80] demonstrates that this vacuum warping is also seen as the degeneracy of the imbeddings of stationary spherically symmetric metrics. Denote the coordinates of  $M_+^4$  by  $(m^0, r_M, \theta, \phi)$  and those of  $X^4$  by  $(t, r_M, \theta, \phi)$ . The expression for the Reissner-Nordström metric reads as

$$\begin{aligned} ds^2 &= A dt^2 - B dr_M^2 - r_M^2 d\Omega^2 , \\ A &= 1 - \frac{a}{r_M} - \frac{b}{r_M^2} , \quad B = \frac{1}{A} , \\ a &= 2GM , \quad b = G\pi q^2 . \end{aligned} \quad (2.3.1)$$

The imbedding is given by the expression

$$\begin{aligned} \Phi &= \omega_1 t + f(r_M) , \\ \Psi &= k\Phi = \omega_2 t + kf(r_M) , \\ m^0 &= \lambda t + h(r_M) , \\ \lambda &= \sqrt{1 + \frac{R^2 \omega_1^2}{4} s_{\Phi\Phi}^{eff}(\infty)} , \quad k = \frac{\omega_2}{\omega_1} . \end{aligned} \quad (2.3.2)$$

The components of  $s^{eff}$  depend on vacuum extremal. For the imbeddings to  $M^4 \times S_{II}^2$ , where  $S_{II}^2$  is homologically trivial geodesic sphere  $s_{eff}$  reduces to the metric  $ds^2 = R^2 d\Omega^2/4$  of standard  $S^2$ .

The functions  $f(r_M)$  and  $h(r_M)$  are determined by the condition

$$\lambda \partial_{r_M} h = \frac{R^2}{4} s_{\Phi\Phi}^{eff} \omega_1 \partial_{r_M} f \quad (2.3.3)$$

resulting from the requirement  $g_{tr_M} = 0$  and from the expression for  $g_{r_M r_M} = -B$ :

$$\begin{aligned} h &= \int dr_M \sqrt{Y} , \quad Y = \frac{Y_1}{Y_2} , \\ Y_1 &= -B + 1 + \frac{R^2}{4} s_{\Theta\Theta}^{eff} \frac{(\partial_{r_M} u)^2}{(1-u^2)} , \\ Y_2 &= 1 - \frac{4\lambda^2}{R^2 \omega_1^2} \frac{s_{\Theta\Theta}^{eff}}{s_{\Phi\Phi}^{eff}} . \end{aligned} \quad (2.3.4)$$

The condition  $g_{tt} = 1$  at infinite distance implies the condition

$$\lambda^2 - \frac{R^2 \omega_1^2}{4} s_{\Phi\Phi}^{eff}(\infty) = 1 . \quad (2.3.5)$$

This condition fixes only the ratio  $\lambda/\omega_1$  so that a one-parameter family of analogs of warped imbeddings results.

If  $m^0$  is used as a time coordinate, anomalous time dilation is obtained also at  $r_M \rightarrow \infty$  and is given by

$$\sqrt{g_{m^0 m^0}} = \frac{1}{\lambda} . \quad (2.3.6)$$

This time dilation is seen only if the clocks to be compared are at different space-time sheets. The anomalous time dilation can be quite large since the order of magnitude for the parameter  $\omega R$  is naturally of order one for the imbeddings of R-N metrics [K80] .

### Mechanisms producing anomalous time dilation

Anomalous time dilation could result in many manners.

1. An adiabatic variation of the parameters  $\lambda$  and  $\omega_1$  of the space-time sheet containing the clock could be induced by some physical mechanism. For instance,  $X_c^4$  could move "over" a large space-time sheet  $X^4$  and gradually form  $\#$  and  $\#_B$  contacts with it. Topological light rays (MEs) define a good candidate for  $X^4$ . The parameter values  $\lambda$  and  $\omega$  could change quasi-continuously if  $X_c^4$  gradually generates  $CP_2$  sized wormhole contacts or join along boundaries bonds connecting it to  $X^4$ . This process would not affect the gravitational flux feeded to  $X_c^4$ .

For instance, if  $X^4$  is at rest with respect to Earth, this motion would result from the rotation of Earth and the effect should appear periodically from day to day. If it is at rest with respect to Sun, the effect should appear once a year.

The generation of vacuum extremals  $X_{vac}^4$  (not gravitational vacua), which is in principle possible even by intentional action since conservation laws are not broken, could induce anomalous time dilation by this mechanism.

2. A phase transition increasing the value of  $\hbar$  increases the size of the space-time sheet in the same proportion. This transition could quite well affect also the parameter  $\lambda$ . If this phase transition occurs for the space-time sheet  $X_c^4$  at which the clock feeds its gravitational flux, this mechanism could provide a feasible manner to induce an anomalous time dilation.
3. The system containing the clock could suffer a temporary topological condensation to a smaller space-time sheet and thus feed its gravitational flux to this space-time sheet. This would require coherently occurring splitting of  $\#$  contacts and their regeneration. It is not possible to say anything definite about the probability of this kind of process except that it does not look very feasible.

### The findings of Chernobrov

The findings claimed by Russian researcher V. Chernobrov support anomalous time dilation effect [J12, J26]. Chernobrov has studied anomalies in the rate of time flow defined operationally by comparing the readings of clocks enclosed inside a spherical volume with the readings of clocks outside this volume. The experimental apparatus involves a complex Russian doll like structure of electromagnets.

Chernobrov reports a slowing down of time by about 30 seconds per hour inside his experimental apparatus [J12] so that the average dilation factor during hour would be about  $\Delta = 1/120$ . If the dilation is present all the time, the anomalous contribution to the gravitational potential would be by a factor  $\sim 10^7$  larger than that of Earth's gravitational potential and huge gravitational perturbations would be required to produce this kind of effect.

The slowing of the time flow is reported to occur gradually whereas the increase for the rate of time flow is reported to occur discontinuously. Time dilation effects were observed in connection with the cycles of moon, diurnal fluctuations, and even the presence of operator.

Consider now the explanation of the basic qualitative findings of Chernobrov.

1. The gradual slowing of the time flow suggests that the parameter values of  $\lambda$  and  $\omega$  change adiabatically. This favors option 1) since the formation of  $\#$  contacts occurs with some finite rate.
2. Also the sudden increase of the rate of time flow is consistent with option 1) since the splitting of  $\#$  contacts occurs immediately when the sheets  $X_c^4$  and  $X^4$  are not "over" each other.
3. The occurrence of the effect in connection with the cycles of moon, diurnal fluctuations, and in the presence of operator support this interpretation. The last observation would support the view that intentional generation of almost vacuum space-time sheets is indeed possible.



### Vacuum extremals as means of generating time dilation effects intentionally?

Field equations allow a gigantic family of vacuum extremals: any 4-surface having  $CP_2$  projection, which belongs to a 2-dimensional Legendre manifold with a vanishing induced Kähler form, is a vacuum extremal. Canonical transformations and diffeomorphisms of  $CP_2$  produce new vacuum extremals. Vacuum extremals carry non-vanishing classical electro-weak and color fields which are reduced to some  $U(1)$  subgroup of the full gauge group and also classical gravitational field. Although the vacuum extremals are not absolute minima, their small deformations could define such. These vacuum extremals, call them  $X_{vac}^4$  for brevity, could be generated by intentional action. In the first quantum jump the p-adic variant of the vacuum extremal representing an intention to create  $X_{vac}^4$  would appear and in some subsequent quantum jump it would be transformed to a real space-time sheet.

The creation of these almost vacuum extremals could generate time dilation effects. The material system would gradually generate  $CP_2$  sized wormhole contacts and/or join along boundaries connecting its space-time sheet to  $X_{vac}^4$  and this could change the values of the vacuum parameters  $\lambda, \omega$ .

### 2.3.2 Anomalies related to spinning astrophysical objects

Kozyrev [H32] has conducted astronomical observations using a receiving system of a new type. These observations have been replicated later by other groups [H23] .

1. When a telescope was directed at a certain star, the detector positioned within the telescope registered the incoming signal even if the main mirror of the telescope was shielded by metal screens. This indicated that electromagnetic waves were accompanied by some waves not shielded by the metal screens.
2. When the telescope was directed to the true position, the signal became stronger. As if there had been almost instantaneous propagation of signal with velocity billions times greater than the velocity of light.
3. When the telescope was directed to a position symmetrical with respect to visible position, again signal was detected: the imaginative interpretation was that the signal came from future position of the star!

Leaving aside the objections of a typical sceptic and the question whether the effect is real or not, one can ask whether the concepts of many-sheeted space-time concept and classical  $Z^0$  field could somehow give rise to this kind of effect in strong conflict with conventional wisdom.

1. Very light dark gluons and electro-weak bosons (extremely tiny  $CP_2$  type vacuum extremals glued to macroscopic space-time sheet) could have the propagating classical color and weak gauge fields, in particular  $Z^0$  field, as a space-time correlate. This field can be said to cause the effect in the detector.
2. The strong signal from the true position could have explanation in terms of a coherent classical  $Z^0$  field of astronomical size. This kind of coherence is forced by the imbeddability requirement and was coined as topological field quantization in [K36] . One can intuitively understand it as follows. In TGD elementary particle is replaced with 3-surface, which can have arbitrarily large size and absolute minimization of Kähler action forces 3-surface to behave coherently like single particle (in case that it does not so, it decomposes into disjoint components!).

The results of Kozyrev are not the only evidence for this kind of behavior. Total eclipses of the Sun by the Moon reach maximum eclipse about 40 seconds before Sun's and Moon's gravitational forces on Earth align [H55] . If gravity is a propagating force, this 3-body test implies that gravity propagates at least 20 times faster than light. The result is consistent with the assumption that the acceleration of Earth is towards the true instantaneous direction of the Sun now, rather than being parallel to the direction of the arriving solar photons now. TGD based explanation is that the changes of the classical gravitational field are not propagating effects but that the classical gravitational field behaves like single coherent whole (it could of course contain also small propagating part).

3. The signal in the symmetric position could come from geometric future. Only classical gauge fields can carry this kind of signal. One possibility is that classical fields generated by astronomical object propagate in both future and past. A more attractive possibility is that classical  $Z^0$  field propagated along space-time sheet with negative time orientation: for negative time orientation the propagation is expected to occur backwards in time.

This picture is in accordance with the TGD based explanation for the poorly understood observations of Faraday, for the functioning of Searl machine [H49], and for the claim that the efficiency of DePalma generator [H20] and space energy generator of Tewari [H6] could be apparently larger than one. Thus a general pattern behind the anomalies seems to emerge.

1. The basic idea is that space-time sheets with negative time orientation have negative sign of classical energy: this follows solely from the assumption that space-time is 4-surface.
2. The rotating 3-surface associated with the rotating conductor carries vacuum charge density and charge conservation requires the presence of a space-time sheet with opposite sign of charge density. If the time orientation of this space-time sheet is negative, it has negative classical energy and energy conservation requires that material space-time sheet has correspondingly larger energy, which in principle makes possible energy production with apparent efficiency larger than one. The actual mechanism of energy gain would be however time mirror mechanism (see fig. <http://www.tgdtheory.fi/appfigures/timemirror.jpg> or fig. 24 in the appendix of this book). The system generates negative energy bosons (phase conjugate laser beams having topological light rays as space-time correlates) received by another system analogous to a population inverted laser. A phase transition like transition to the round state is thus induced and strong beam of positive energy bosons is emitted and received by the sender of the negative energy signal. This mechanism is discussed in detail in the chapter "The Notion of Free Energy and Many-Sheeted Space-Time Concept" [K78].
3. Stars are rapidly rotating objects carrying magnetic and  $Z^0$  magnetic fields and somewhat like scaled up versions of Searl machine and this suggests that vacuum charge density and space-time sheet with negative time orientation are generated also in this case.

## 2.4 Is electro-gravity possible in TGD framework?

The interpretation of the classical gravitational fields has been one of the messy parts of TGD.

1. When I started to develop TGD, the only reasonable guess was that they really correspond to the measured gravitational fields. There is however an objection against this interpretation. First of all, only a very limited repertoire of space-time metrics can be imbedded as induced metrics in  $H = M_+^4 \times CP_2$ . Already rotating black-hole metrics are impossible to imbed and imbedding would require hundreds of imbedding space dimensions in the general case.
2. Much later it became clear that all elementary particles, with gravitons included, correspond to  $CP_2$  type extremals which are the TGD counterparts of strings (TGD of course allows also cosmic strings). The exchange of these gravitons gives rise to the gravitational interactions. The space-time metric of Einstein's general relativity is only the effective metric associated with coherent states of gravitons. Thus the classical gravitational field, and also classical gauge fields, seem to be something completely new, not encountered in theories in which particles are point like objects or strings. This interpretation resolves nicely the objection related to the imbeddability constraints.
3. A further step of progress came when I learned about the work of R. Y. Chiao about superconductors as transducers and antennas for gravitational and electromagnetic radiation [D13]. The realization was that the non-relativistic limit for gravitational fields allowing to interpret Riemann connection as a Maxwellian field provides surprisingly good understanding of the classical gravitation in TGD Universe and allows also a new model for Podkletnov effect. This work encouraged to take seriously the hypothesis that classical Kähler fields couples to classical gravitational field with a strength which is about  $R^2/G \sim 10^7$  times stronger

than ordinary gravitational coupling constant strength ( $R$  is  $CP_2$  size). Skeptic would of course argue that the results represents a fatal internal inconsistency of the theory:  $CP_2$  size must be given by Planck length. This however leads to non-sensible predictions. Now I agree with the skeptic.

4. The understanding of how GRT emerges from TGD as effective theory leads to the resolution of various mysteries revolving around the notion of energy and gravitational mass. GRT limit of TGD can be obtained as effective theory in which  $M^4$  is endowed with an effective metric defined as sum of flat Minkowski metric and sum over the deviations of the effective metrics of various space-time sheets from flat metric. Similar description applies to various gauge fields. Classical form of Equivalence Principle reduces to its formulation in GRT. Newton's constant and cosmological constant follow as predictions.

In particular, the puzzle of too large gravitational constant for non-vacuum imbedding of Reissner Nordström metric (not preferred extremal) disappears since there is no reason to identify the effective metric as induced metric. If space-time becomes in asymptotic space-time regions single sheeted vacuum extremal having say R-N metric, it might make sense to identify the effective metric identified as induced metric.

### 2.4.1 Classical gravitational fields for space-time surfaces for which $CP_2$ projection corresponds to a homologically non-trivial geodesic sphere

In the previous picture the genuinely classical gravitational fields represent a completely new form of gravitational interaction and it is obviously highly interesting to try to understand something about the character of this interaction.

1. The space-time surfaces representable as sub-manifolds of  $M^4_+ \times S^2$ ,  $S^2$  geodesic sphere of  $CP_2$ , are excellent testing ground for ideas. There are two kinds of geodesic spheres: the first one is homologically trivial and corresponds to a vacuum extremal for which induced Kähler form vanishes. Of course, any Legendre manifold  $Y^2$  of  $CP_2$  is as good as  $S^2$  and the canonical transformations of  $CP_2$  give an infinite variety of these manifolds. The second  $S^2$  one is homologically nontrivial and for this induced Kähler form is non-vanishing. In both cases induced Abelian gauge fields are present and color rotations act as symmetries mixing classical em and  $Z^0$  fields.
2. An especially interesting solution ansatz for  $S^2$  is stationary solution ansatz. Standard linear  $M^4$  coordinates  $(m^0, m^i)$  are the proper coordinates for  $X^4$  in this case. For this ansatz the phase angle  $\Phi$  of  $S^2$  complex coordinate is linear in the time coordinate so that the induced metric and gauge fields do not depend on  $M^4$  time  $m^0$ .

$$\Phi = \omega m^0 + f(m^i) \quad , \quad \Theta = \Theta(m^i) \quad .$$

By explicitly writing out the expressions for the components of the induced metric and gauge field involving time as index one has

$$\begin{aligned} g_{00} &= 1 - (R^2/4)\sin^2(\Theta)\omega^2 \quad , \quad g_{0i} = (R^2/4)\sin^2(\Theta)\omega\partial_i f \quad . \\ F_{0i} &= k\sin(\Theta)\omega\partial_i\Theta \quad . \end{aligned} \tag{2.4.1}$$

Here  $k$  is some numerical constant of order unity depending on the imbedding (gauge field can be in any direction in the gauge algebra of electro-weak gauge group and only Kähler field is invariant in color rotations).

If the spatial gradients of  $CP_2$  coordinates satisfy the conditions  $|\nabla\Theta| \ll \omega$  and  $|\nabla\Phi| \ll \omega$ , the deviations of  $g_{ij}$  from the flat 3-metric are small as compared to the components  $g_{0\alpha}$ , and one has what can be identified as a non-relativistic limit of the theory. Also the components of the magnetic field are small in consistency with the notion that magnetic fields are of order  $O(v/c)$  as compared to electric fields in the non-relativistic limit.

Of course, the solutions form an extremely restricted set: for instance, electric and magnetic field are orthogonal to each other. On the other hand, criticality of the preferred extremals of Kähler action in the sense of having an infinite number of deformations for which the second variation of Kähler action vanishes, is expected to select very limited set of field configurations and highly symmetric ones with electric field dominating are the favored ones. Preferred extremals is nothing but the analog of Bohr orbits in wave mechanism. The study of this limit is especially revealing concerning the interpretation of the classical gravitational fields.

3. In the non-relativistic limit Einstein's theory reduces effectively to a Maxwellian theory with  $g_{00} \equiv \Phi_g$  taking the role of the scalar potential of the gravito-electric field and  $g_{ti} \equiv A_i$  taking the role of the components of the vector potential. Christoffel symbols represent gravitoelectric and gravito-magnetic fields and the components  $(G^{00}, G^{0i}) \equiv (J_g^0, J_g^i)$  of the Einstein tensor represent four current (charge density and 3-current). This interpretation provides a very attractive phenomenological manner to understand the non-relativistic limit of the theory. The natural interpretation is as a dimensional reduction in which the theory reduces to a 3-dimensional gravitational theory coupled to gravito-Maxwell field so that the energy momentum current  $(J_g^0, J_g^i)$  becomes a gauge current. If the interpretation is correct, then three-dimensional Einstein equations should be satisfied in the sense that  $G^{ij}$  can be interpreted as the canonical energy momentum tensor for the gravito-Maxwellian field. The fact that this tensor is quadratic in  $\nabla\Theta$  is consistent with this.
4. One can calculate explicitly gravito-Maxwellian field and one finds

$$\begin{aligned} E_{g,i} &= \nabla_i g_{00} = (R^2 \omega^2 / 2) \cos(\Theta) \nabla_i \cos(\Theta) \ , \\ B_{g,ij} &= (R^2 \omega / 2) \cos(\Theta) [\nabla_i \cos(\Theta) \nabla_j f - (i \leftrightarrow j)] \ . \end{aligned} \quad (2.4.2)$$

One can write the components of gravito-Maxwell fields in terms of the gauge potential components alone by noticing that the gauge potential  $(F_{\mu\nu} = \nabla_\nu A_\mu - \nabla_\mu A_\nu)$  for the ordinary  $U(1)$  gauge field is given by

$$A_0 = [-\cos(\Theta_0) + \cos(\Theta)] \omega \ , \quad A_i = [-\cos(\Theta_0) + \cos(\Theta)] \nabla_i f \ . \quad (2.4.3)$$

Here  $\cos(\Theta_0) = -1$  holds true for a potential which is well defined around the south pole of  $S^2$  and  $\cos(\Theta_0) = 1$  for a potential well-defined around the north pole (monopole field is in question).  $\cos(\Theta_0) = 0$  holds true for a potential defined in the region outside the northern and southern poles. The gravito-Maxwell fields are given by the expression

$$\begin{aligned} E_{g,i} &= (R^2 / 2) [A_0 + \cos(\Theta_0) \omega] E_i \ , \\ B_{g,ij} &= (R^2 / 2) [A_0 + \cos(\Theta_0) \omega] B_{ij} \ . \end{aligned} \quad (2.4.4)$$

The beautiful result is that gravito-Maxwell fields is related to the Maxwell field with a proportionality factor expressible in terms of the scalar potential. This finding gives strong support to the ideas about electro-gravity stating that classical electromagnetic fields are accompanied by strong gravitational fields. Note however that this result involves the assumption about coherence. If coherence is absent classical gauge fields and gravitational field can reside at different space-time sheets.

### 2.4.2 TGD does not predict anomalously large coupling of gravitation to classical gauge fields

The explicit calculation of the components of the Einstein tensor in the non-relativistic approximation (charge density and 3-current associated with  $E_g$  and  $G_g$ ) gives a very nice result.  $(G^{00}, G^{0i})$  are proportional to the corresponding components of the canonical energy momentum tensor of the Maxwell field plus the interaction term with four current in case that  $E$  and  $B$  give rise to non-vanishing vacuum charge density and current: this is quite possible in TGD framework. A good guess is that the divergence of  $G^{ij}$  gives rise to the spatial components of the Maxwellian energy momentum tensor and that Maxwell-Einstein equations are identically satisfied.

The calculation of the Einstein tensor also demonstrates that under the assumption that Equivalence Principle holds true the value of the gravitational constant is given by

$$G_{cl} = R^2 g^2 = R^2 \times 4\pi \times \alpha \quad (2.4.5)$$

where  $\alpha = g^2/4\pi$  represents the effective gauge coupling of the  $U(1)$  gauge field in question. This coupling enters because the induced gauge potential is  $gA_\mu$  rather than  $A_\mu$  by definition so that energy momentum density is proportional to  $1/g^2$ . p-Adic mass calculations fix the value of  $R^2$  from electron mass scale and also a reasonable value for the string tension of cosmic strings implies  $R^2 \sim 10^8 G$ . Hence the value of  $G_{cl}$  is roughly  $G_{cl} \sim 10^7 G$  in electromagnetic case and seven orders of magnitude stronger than the gravitational coupling associated with the graviton exchange.

The resolution of the puzzling result has been already described. R-N metric does not allow imbedding as non-vacuum extremal and the effective metric for  $M^4$  defining the GRT limit of TGD in long length scales need not be equal to the induced metric. One cannot however exclude the possibility that the effective metric co-incides with the induced metric for vacuum extremal: in this case the gravitational constant remains free parameter.

Although the result as such kills the idea about strong gravity associated with the classical gauge fields, the implications of the result that classical fields are related to gravitational field in a very simple manner could be non-trivial. If TGD indeed predicts correctly the gravitational coupling associated with the exchange of  $CP_2$  type extremals, then classical gauge fields associated with the physical systems can give additional very strong contribution to the gravitational field generated by the body. If one assumes that the classical gauge fields have as their sources ordinary matter (purely vacuum charge densities are not excluded), highly charged objects are expected to exhibit gravitational anomalies. Not only electro-gravity but also  $Z^0$  gravity are possible: any  $U(1)$  gauge field can define vacuum gravity. There are two basic situations: non-vacuum situation in which Kähler form is the natural gauge field and identifiable as being associated with the  $U(1)$  factor of electro-weak gauge group and vacuum situation in which gauge field in is  $SU(2)_L$  algebra. In the latter case the extremization does not pose any limitations to the imbedding but criticality is expected to select small deformations of some extremals.

Also the general solutions of the field equations representable as maps from  $M^4$  to  $CP_2$  give additional contribution to the gravitational interaction. In this case it is however not clear whether the Einstein tensor allows a solution of Einstein's equations for some simple system.

### 2.4.3 Gravito-Maxwell field associated with a dipole field

A little explicit calculation modelling the Maxwell field as a dipole field demonstrates that the gravitational field has quadrupole character and that the additional mass associated with the disk is positive. This involves two delicate facts. Dipole gauge potential  $A_0 \propto \bar{p} \cdot \bar{r}/r^3$  vanishes at the equator. One has

$$A_0 = [\cos(\Theta) + \cos(\Theta_0)] \omega = \frac{1}{4\pi} \frac{\bar{p} \cdot \bar{r}}{r^3} . \quad (2.4.6)$$

Gravito-Maxwell field is obtained from the dipole field by multiplying it with  $A_0$ -factor.

1. For  $\cos(\theta_0) = 0$  one obtains

$$\bar{E}_g = \frac{R^2}{2} A_0 \times \bar{E} = \frac{R^2}{2} \frac{p^2}{16\pi^2} \cos(\theta) \times [\bar{e}_z - 3\cos(\theta)\bar{e}_r] \frac{1}{r^5} .$$

Note that  $\theta$  refers to the angle variable of  $M^4$  spherical coordinates. Since  $A_0$ -factor vanishes at the equator and has opposite sign above and below equator, one obtains quadrupole type gravito-Maxwell field and it is easy to verify that it can be interpreted as attractive gravitational field generated by the super-conductor. Note that the sign of the gravito-Maxwell field does not depend on the sign of the dipole moment nor on the sign of the frequency  $\omega$ . The field in question behaves as  $1/r^5$  so that the gravitational anomaly is only felt in the region near to the non-rotating super-conductor.

2. For  $\cos(\theta_0) = \pm 1$  on opposite sides of the hemisphere one has

$$A_0 = \cos(\Theta)\omega = \epsilon\omega + \frac{1}{4\pi} \frac{\bar{p} \cdot \bar{r}}{r^3} . \quad (2.4.7)$$

The requirement that the potential is imbeddable for  $r > d$  ( $\cos(\Theta) \leq 1$ ), where  $d$  characterizes the source region (super-conductor), implies

$$|\omega| \geq \omega_{min} = \frac{|p|}{4\pi d^2} . \quad (2.4.8)$$

In this case one has

$$\bar{E}_g = \frac{R^2}{2} \frac{p}{4\pi} \left[ \epsilon\omega + \frac{p\cos(\theta)}{4\pi r^2} \right] \times [\bar{e}_z - 3\cos(\theta)\bar{e}_r] \frac{1}{r^3} . \quad (2.4.9)$$

For  $r^2 \gg p/(4\pi\omega)$   $\cos(\Theta)$  is effective constant and the behavior of the gravito-Maxwell field is in a good approximation

$$\bar{E}_g \simeq \frac{R^2}{2} \frac{p}{4\pi} \epsilon\omega \times [\bar{e}_z - 3\cos(\theta)\bar{e}_r] \frac{1}{r^3} . \quad (2.4.10)$$

The gravito-Maxwell field decreases as  $1/r^3$  asymptotically for all values of  $\theta$ . What is remarkable that even in the nearby region not too near to north and south pole it is possible to have a situation in which the constant term is much larger than the dipole term in the potential. The field changes sign at the equator: this is consistent with the fact that gravitational field cannot be a dipole field and expresses the fact that equator effectively acts as a charged sheet carrying gravito-Maxwell charge density. It must be emphasized that the singular behavior is actually due to the monopole character of the gauge field in turn reflecting itself in the monopole character of Riemann connection and thus also of the gravito-Maxwell scalar potential.

Order of magnitude estimate using the acceleration in Earth's gravitational field as a comparison standard is in order.

1. Consider first di-electric. Let the size of the system be  $d$  and dipole strength  $p = \alpha N d^3$ ,  $N = \epsilon N_n x a$ ,  $N_n$  is the density of nuclei,  $\epsilon N_n$  the density of polarizable charge and  $x a$  the distance between polarized charges in nucleus expressed using atomic radius as a unit.

This gives the order of magnitude estimate

$$\frac{E_g c^2}{g} \sim \frac{\alpha^2}{2} \epsilon^2 x^2 \frac{R^2 a^2 c^2}{g L^5} N_n^2 d^6 . \quad (2.4.11)$$

2. In the case of conducting sphere of radius  $r$  with dipole moment  $p \sim Qd$ ,  $\sigma \sim \epsilon N_n x a d^2$ , with  $xa$  denoting the thickness of surface charge layer one obtains the following estimate:

$$\frac{E_g c^2}{g} \sim \frac{\alpha^2}{2} \epsilon^2 x^2 \frac{R^2 a^2 c^2}{g L^5} N_n^2 d^6 . \quad (2.4.12)$$

The orders of magnitude are same. For  $L = 1$  m,  $d = .1$  m,  $a = 10^{-10}$  m,  $N_n = \frac{10^{30}}{A}/\text{m}^3$ ,  $A$  atomic number and using  $g = 10 \text{ m}^2/\text{s}$ ,  $R \sim 10^{-30}$  m, one has  $\frac{E_g c^2}{g} \sim 10^{-14} \epsilon^2 x^2 / A^2$ . Hence the effect on the gravitational field is very weak.

## 2.5 Allais effect and TGD

### 2.5.1 Introduction

Allais effect [E2, E12] is a fascinating gravitational anomaly associated with solar eclipses. It was discovered originally by M. Allais, a Nobelist in the field of economy, and has been reproduced in several experiments but not as a rule. The experimental arrangement uses so called paraconical pendulum, which differs from the Foucault pendulum in that the oscillation plane of the pendulum can rotate in certain limits so that the motion occurs effectively at the surface of sphere.

#### Experimental findings

Consider first a brief summary of the findings of Allais and others [E12] .

1. In the ideal situation (that is in the absence of any other forces than gravitation of Earth) paraconical pendulum should behave like a Foucault pendulum. The oscillation plane of the paraconical pendulum however begins to rotate.
2. Allais concludes from his experimental studies that the orbital plane approach always asymptotically to a limiting plane and the effect is only particularly spectacular during the eclipse. During solar eclipse the limiting plane contains the line connecting Earth, Moon, and Sun. Allais explains this in terms of what he calls the anisotropy of space.
3. Some experiments carried out during eclipse have reproduced the findings of Allais, some experiments not. In the experiment carried out by Jeverdan and collaborators in Romania it was found that the period of oscillation of the pendulum decreases by  $\Delta f/f \simeq 5 \times 10^{-4}$  [E2, E21] which happens to correspond to the constant  $v_0 = 2^{-11}$  appearing in the formula of the gravitational Planck constant. It must be however emphasized that the overall magnitude of  $\Delta f/f$  varies by five orders of magnitude. Even the sign of  $\Delta f/f$  varies from experiment to experiment.
4. There is also quite recent finding by Popescu and Olenici, which they interpret as a quantization of the plane of oscillation of paraconical oscillator during solar eclipse [E27] .

#### TGD based models for Allais effect

I have already earlier proposed an explanation of the effect in terms of classical  $Z^0$  force. If the  $Z^0$  charge to mass ratio of pendulum varies and if Earth and Moon are  $Z^0$  conductors, the resulting model is quite flexible and one might hope it could explain the high variation of the experimental results.

The rapid variation of the effect during the eclipse is however a problem for this approach and suggests that gravitational screening or some more general interference effect might be present. Gravitational screening alone cannot however explain Allais effect. Also the combination of gravitational screening and  $Z^0$  force assuming  $Z^0$  conducting structures causing screening fails to explain the discontinuous behavior when massive objects are collinear.

A model based on the idea that gravitational interaction is mediated by topological light rays (MEs) and that gravitons correspond to a gigantic value of the gravitational Planck constant however explains the Allais effect as an interference effect made possible by macroscopic quantum coherence in astrophysical length scales. Equivalence Principle fixes the model to a high degree and one ends up with an explicit formula for the anomalous gravitational acceleration and the general order of magnitude and the large variation of the frequency change as being due to the variation of the distance ratio  $r_{S,P}/r_{M,P}$  ( $S$ ,  $M$ , and  $P$  refer to Sun, Moon, and pendulum respectively). One can say that the pendulum acts as an interferometer.

### 2.5.2 Could gravitational screening explain Allais effect

The basic idea of the screening model is that Moon absorbs some fraction of the gravitational momentum flow of Sun and in this manner partially screens the gravitational force of Sun in a disk like region having the size of Moon's cross subsection. The screening is expected to be strongest in the center of the disk. Screening model happens to explain the findings of Jevardan but fails in the general case. Despite this screening model serves as a useful exercise.

#### Constant external force as the cause of the effect

The conclusions of Allais motivate the assumption that quite generally there can be additional constant forces affecting the motion of the paraconical pendulum besides Earth's gravitation. This means the replacement  $\bar{g} \rightarrow \bar{g} + \Delta\bar{g}$  of the acceleration  $g$  due to Earth's gravitation.  $\Delta\bar{g}$  can depend on time.

The system obeys still the same simple equations of motion as in the initial situation, the only change being that the direction and magnitude of effective Earth's acceleration have changed so that the definition of vertical is modified. If  $\Delta\bar{g}$  is not parallel to the oscillation plane in the original situation, a torque is induced and the oscillation plane begins to rotate. This picture requires that the friction in the rotational degree of freedom is considerably stronger than in oscillatory degree of freedom: unfortunately I do not know what the situation is.

The behavior of the system in absence of friction can be deduced from the conservation laws of energy and angular momentum in the direction of  $\bar{g} + \Delta\bar{g}$ . The explicit formulas are given by

$$\begin{aligned} E &= \frac{ml^2}{2} \left( \frac{d\Theta}{dt} \right)^2 + \sin^2(\Theta) \left( \frac{d\Phi}{dt} \right)^2 + mgl \cos(\Theta) \ , \\ L_z &= ml^2 \sin^2(\Theta) \frac{d\Phi}{dt} \ . \end{aligned} \quad (2.5.1)$$

and allow to integrate  $\Theta$  and  $\Phi$  from given initial values.

#### What causes the effect in normal situations?

The gravitational accelerations caused by Sun and Moon come first in mind as causes of the effect. Equivalence Principle implies that only relative accelerations causing analogs of tidal forces can be in question. In GRT picture these accelerations correspond to a geodesic deviation between the surface of Earth and its center. The general form of the tidal acceleration would thus be the difference of gravitational accelerations at these points:

$$\Delta\bar{g} = -2GM \left[ \frac{\Delta\bar{r}}{r^3} - 3 \frac{\bar{r} \cdot \Delta\bar{r}}{r^5} \bar{r} \right] \ . \quad (2.5.2)$$

Here  $\bar{r}$  denotes the relative position of the pendulum with respect to Sun or Moon.  $\Delta\bar{r}$  denotes the position vector of the pendulum measured with respect to the center of Earth defining the geodesic deviation. The contribution in the direction of  $\Delta\bar{r}$  does not affect the direction of the Earth's acceleration and therefore does not contribute to the torque. Second contribution corresponds to an acceleration in the direction of  $\bar{r}$  connecting the pendulum to Moon or Sun. The direction of this vector changes slowly.

This would suggest that in the normal situation the tidal effect of Moon causes gradually changing force  $m\Delta\bar{g}$  creating a torque, which induces a rotation of the oscillation plane. Together



with dissipation this leads to a situation in which the orbital plane contains the vector  $\Delta\bar{g}$  so that no torque is experienced. The limiting oscillation plane should rotate with same period as Moon around Earth. Of course, if effect is due to some other force than gravitational forces of Sun and Earth, paraconical oscillator would provide a manner to make this force visible and quantify its effects.

### What would happen during the solar eclipse?

During the solar eclipse something exceptional must happen in order to account for the size of effect. The finding of Allais that the limiting oscillation plane contains the line connecting Earth, Moon, and Sun implies that the anomalous acceleration  $\Delta|g$  should be parallel to this line during the solar eclipse.

The simplest hypothesis is based on TGD based view about gravitational force as a flow of gravitational momentum in the radial direction.

1. For stationary states the field equations of TGD for vacuum extremals state that the gravitational momentum flow of this momentum. Newton's equations suggest that planets and moon absorb a fraction of gravitational momentum flow meeting them. The view that gravitation is mediated by gravitons which correspond to enormous values of gravitational Planck constant in turn supports Feynman diagrammatic view in which description as momentum exchange makes sense and is consistent with the idea about absorption. If Moon absorbs part of this momentum, the region of Earth screened by Moon receives reduced amount of gravitational momentum and the gravitational force of Sun on pendulum is reduced in the shadow.
2. Unless the Moon as a coherent whole acts as the absorber of gravitational four momentum, one expects that the screening depends on the distance travelled by the gravitational flux inside Moon. Hence the effect should be strongest in the center of the shadow and weaken as one approaches its boundaries.
3. The opening angle for the shadow cone is given in a good approximation by  $\Delta\Theta = R_M/R_E$ . Since the distances of Moon and Earth from Sun differ so little, the size of the screened region has same size as Moon. This corresponds roughly to a disk with radius  $.27 \times R_E$ .

The corresponding area is 7.3 per cent of total transverse area of Earth. If total absorption occurs in the entire area the total radial gravitational momentum received by Earth is in good approximation 92.7 per cent of normal during the eclipse and the natural question is whether this effective repulsive radial force increases the orbital radius of Earth during the eclipse.

More precisely, the deviation of the total amount of gravitational momentum absorbed during solar eclipse from its standard value is an integral of the flux of momentum over time:

$$\begin{aligned} \Delta P_{gr}^k &= \int \frac{\Delta P_{gr}^k}{dt}(S(t))dt \ , \\ \frac{\Delta P_{gr}^k}{dt}(S(t)) &= \int_{S(t)} J_{gr}^k(t)dS \ . \end{aligned} \quad (2.5.3)$$

This prediction could kill the model in classical form at least. If one takes seriously the quantum model for astrophysical systems predicting that planetary orbits correspond to Bohr orbits with gravitational Planck constant equal to  $GMm/v_0$ ,  $v_0 = 2^{-11}$ , there should be not effect on the orbital radius. The anomalous radial gravitational four-momentum could go to some other degrees of freedom at the surface of Earth.

4. The rotation of the oscillation plane is largest if the plane of oscillation in the initial situation is as orthogonal as possible to the line connecting Moon, Earth and Sun. The effect vanishes when this line is in the initial plane of oscillation. This testable prediction might explain why some experiments have failed to reproduce the effect.

5. The change of  $|\bar{g}|$  to  $|\bar{g} + \Delta\bar{g}|$  induces a change of oscillation frequency given by

$$\frac{\Delta f}{f} = \frac{\bar{g} \cdot \Delta\bar{g}}{g^2} = \frac{\Delta g}{g} \cos(\theta) . \quad (2.5.4)$$

If the gravitational force of the Sun is screened, one has  $|\bar{g} + \Delta\bar{g}| > g$  and the oscillation frequency should increase. The upper bound for the effect corresponds to vertical direction is obtained from the gravitational acceleration of Sun at the surface of Earth:

$$\frac{|\Delta f|}{f} \leq \frac{\Delta g}{g} = \frac{v_E^2}{r_E} \simeq 6.0 \times 10^{-4} . \quad (2.5.5)$$

6. One should explain also the recent finding by Popescu and Olenici, which they interpret as a quantization of the plane of oscillation of paraconical oscillator during solar eclipse [E27] . A possible TGD based explanation would be in terms of quantization of  $\Delta\bar{g}$  and thus of the limiting oscillation plane. This quantization should reflect the quantization of the gravitational momentum flux receiving Earth. The flux would be reduced in a stepwise manner during the solar eclipse as the distance traversed by the flux through Moon increases and reduced in a similar manner after the maximum of the eclipse.

### What kind of tidal effects are predicted?

If the model applies also in the case of Earth itself, new kind of tidal effects are predicted due to the screening of the gravitational effects of Sun and Moon inside Earth. At the night-side the paraconical pendulum should experience the gravitation of Sun as screened. Same would apply to the "night-side" of Earth with respect to Moon.

Consider first the differences of accelerations in the direction of the line connecting Earth to Sun/Moon: these effects are not essential for tidal effects. The estimate for the ratio for the orders of magnitudes of the these accelerations is given by

$$\frac{|\Delta\bar{g}_\perp(Moon)|}{|\Delta\bar{g}_\perp(Sun)|} = \frac{M_S}{M_M} \left(\frac{r_M}{r_E}\right)^3 \simeq 2.17 . \quad (2.5.6)$$

The order or magnitude follows from  $r(Moon) = .0026$  AU and  $M_M/M_S = 3.7 \times 10^{-8}$ . These effects are of same order of magnitude and can be compensated by a variation of the pressure gradients of atmosphere and sea water. The effects caused by Sun are two times stronger. These effects are of same order of magnitude and can be compensated by a variation of the pressure gradients of atmosphere and sea water.

The tangential accelerations are essential for tidal effects. They decompose as

$$\frac{1}{r^3} \left[ \Delta\bar{r} - 3|\Delta\bar{r}|\cos(\Theta)\frac{\bar{r}}{r} \right] .$$

$\pi/4 \leq \Theta \leq \pi/2$  is the angle between  $\Delta\bar{r}$  and  $\bar{r}$ . The above estimate for the ratio of the contributions of Sun and Moon holds true also now and the tidal effects caused by Sun are stronger by a factor of two.

Consider now the new tidal effects caused by the screening.

1. Tangential effects on day-side of Earth are not affected (night-time and night-side are of course different notions in the case of Moon and Sun). At the night-side screening is predicted to reduce tidal effects with a maximum reduction at the equator.
2. Second class of new effects relate to the change of the normal component of the forces and these effects would be compensated by pressure changes corresponding to the change of the effective gravitational acceleration. The night-day variation of the atmospheric and sea pressures would be considerably larger than in Newtonian model.

The intuitive expectation is that the screening is maximum when the gravitational momentum flux travels longest path in the Earth's interior. The maximal difference of radial accelerations associated with opposite sides of Earth along the line of sight to Moon/Sun provides a convenient manner to distinguish between Newtonian and TGD based models:

$$\begin{aligned} |\Delta\bar{g}_{\perp,N}| &= 4GM \times \frac{R_E}{r^3} , \\ |\Delta\bar{g}_{\perp,TGD}| &= 4GM \times \frac{1}{r^2} . \end{aligned} \quad (2.5.7)$$

The ratio of the effects predicted by TGD and Newtonian models would be

$$\begin{aligned} \frac{|\Delta\bar{g}_{\perp,TGD}|}{|\Delta\bar{g}_{\perp,N}|} &= \frac{r}{R_E} , \\ \frac{r_M}{R_E} &= 60.2 , \quad \frac{r_S}{R_E} = 2.34 \times 10^4 . \end{aligned} \quad (2.5.8)$$

The amplitude for the oscillatory variation of the pressure gradient caused by Sun would be

$$\Delta|\nabla p_S| = \frac{v_E^2}{r_E} \simeq 6.1 \times 10^{-4} g$$

and the pressure gradient would be reduced during night-time. The corresponding amplitude in the case of Moon is given by

$$\frac{\Delta|\nabla p_s|}{\Delta|\nabla p_M|} = \frac{M_S}{M_M} \times \left(\frac{r_M}{r_S}\right)^3 \simeq 2.17 .$$

$\Delta|\nabla p_M|$  is in a good approximation smaller by a factor of 1/2 and given by  $\Delta|\nabla p_M| = 2.8 \times 10^{-4} g$ . Thus the contributions are of same order of magnitude.

$M_M/M_S$	$M_E/M_S$	$R_M/R_E$	$d_{E-S}/AU$	$d_{E-M}/AU$
$3.0 \times 10^{-6}$	$3.69 \times 10^{-8}$	.273	1	.00257
$R_E/d_{E-S}$	$R_E/d_{E-M}$	$g_S/g$	$g_M/g$	
$4.27 \times 10^{-5}$	$01.7 \times 10^{-7}$	$6.1 \times 10^{-4}$	$2.8 \times 10^{-4}$	

Table 1. The table gives basic data relevant for tidal effects. The subscript  $E, S, M$  refers to Earth, Sun, Moon;  $R$  refers to radius;  $d_{X-Y}$  refers to the distance between  $X$  and  $Y$   $g_S$  and  $g_M$  refer to accelerations induced by Sun and Moon at Earth surface.  $g = 9.8 \text{ m/s}^2$  refers to the acceleration of gravity at surface of Earth. One has also  $M_S = 1.99 \times 10^{30} \text{ kg}$  and  $AU = 1.49 \times 10^{11} \text{ m}$ ,  $R_E = 6.34 \times 10^6 \text{ m}$ .

One can imagine two simple qualitative killer predictions assuming maximal gravitational screening.

1. Solar eclipse should induce anomalous tidal effects induced by the screening in the shadow of the Moon.
2. The comparison of solar and moon eclipses might kill the scenario. The screening would imply that inside the shadow the tidal effects are of same order of magnitude at both sides of Earth for Sun-Earth-Moon configuration but weaker at night-side for Sun-Moon-Earth situation.

### An interesting co-incidence

The value of  $\Delta f/f = 5 \times 10^{-4}$  in experiment of Jeverdan is exactly equal to  $v_0 = 2^{-11}$ , which appears in the formula  $\hbar_{gr} = GMm/v_0$  for the favored values of the gravitational Planck constant. The predictions are  $\Delta f/f \leq \Delta p/p \simeq 3 \times 10^{-4}$ . Powers of  $1/v_0$  appear also as favored scalings of Planck constant in the TGD inspired quantum model of bio-systems based on dark matter [K22]. This co-incidence would suggest the quantization formula

$$\frac{g_E}{g_S} = \frac{M_S}{M_E} \times \frac{R_E^2}{r_E^2} = v_0 \quad (2.5.9)$$

for the ratio of the gravitational accelerations caused by Earth and Sun on an object at the surface of Earth.

It must be however admitted that the larger variation in the magnitude and even sign of the effect does not favor this kind of interpretation.

### Summary of the predicted new effects

Let us sum up the basic predictions of the model assuming maximal gravitational screening.

1. The first prediction is the gradual increase of the oscillation frequency of the conical pendulum by  $\Delta f/f \leq 3 \times 10^{-4}$  to maximum and back during night-time in case that the pendulum has vanishing  $Z^0$  charge. Also a periodic variation of the frequency and a periodic rotation of the oscillation plane with period co-inciding with Moon's rotation period is predicted. Already Allais observed both 24 hour cycle and cycle which is slightly longer and due to the fact that Moon rates around Earth.
2. A paraconical pendulum with initial position, which corresponds to the resting position in the normal situation should begin to oscillate during solar eclipse. This effect is testable by fixing the pendulum to the resting position and releasing it during the eclipse. The amplitude of the oscillation corresponds to the angle between  $\bar{g}$  and  $\bar{g} + \Delta\bar{g}$  given in a good approximation by

$$\sin[\Theta(\bar{g}, \bar{g} + \Delta\bar{g})] = \frac{\Delta g}{g} \sin[\Theta(\bar{g}, \Delta\bar{g})] . \quad (2.5.10)$$

An upper bound for the amplitude would be  $\Theta \leq 3 \times 10^{-4}$ , which corresponds to .015 degrees.  $Z^0$  charge of the pendulum would modify this simple picture.

3. Gravitational screening should cause a reduction of tidal effects at the "night-side" of Moon/Sun. The reduction should be maximum at "midnight". This reduction together with the fact that the tidal effects of Moon and Sun at the day side are of same order of magnitude could explain some anomalies know to be associated with the tidal effects [F4] . A further prediction is the day-night variation of the atmospheric and sea pressure gradients with amplitude which is for Sun  $3 \times 10^{-4}g$  and for Moon  $1.3 \times 10^{-3}g$ .

To sum up, the predicted anomalous tidal effects and the explanation of the limiting oscillation plane in terms of stronger dissipation in rotational degree of freedom could kill the model assuming only gravitational screening.

### Comparison with experimental results

The experimental results look mutually contradictory in the context provided by the model assuming only screening. Some experiments find no anomaly at all as one learns from [E2] . There are also measurements supporting the existence of an effect but with varying sign and quite different orders of magnitude. Either the experimental determinations cannot be trusted or the model is too simple.

1. The *increase* (!) of the frequency observed by Jeverdan and collaborators reported in Wikipedia article [E2] for Foucault pendulum is  $\Delta f/f \simeq 5 \times 10^{-4}$  would support the model even quantitatively since this value is only by a factor 5/3 higher than the maximal effect allowed by the screening model. Unfortunately, I do not have an access to the paper of Jeverdan *et al* to find out the value of  $\cos(\Theta)$  in the experimental arrangement and whether there is indeed a decrease of the period as claimed in Wikipedia article. In [E17] two experiments supporting an effect  $\Delta g/g = x \times 10^{-4}$ ,  $x = 1.5$  or  $2.6$  but the sign of the effect is different in these experiments.

2. Allais reported an anomaly  $\Delta g/g \sim 5 \times 10^{-6}$  during 1954 eclipse [E5]. According to measurements by authors of [E17] the period of oscillation increases and one has  $\Delta g/g \sim 5 \times 10^{-6}$ . Popescu and Olenici report a decrease of the oscillation period by  $(\Delta g/g)\cos(\Theta) \simeq 1.4 \times 10^{-5}$ .
3. In [E19] a *reduction* of vertical gravitational acceleration  $\Delta g/g = (7.0 \pm 2.7) \times 10^{-9}$  is reported: this is by a factor  $10^{-5}$  smaller than the result of Jeverdan.
4. Small pressure waves with  $\Delta p/p = 2 \times 10^{-5}$  are registered by some micro-barometers [E5] and might relate to the effect since pressure gradient and gravitational acceleration should compensate each other.  $\Delta g \cos(\Theta)/g$  would be about 7 per cent of its maximum value for Earth-Sun system in this case. The knowledge of the sign of pressure variation would tell whether effective gravitational force is screened or amplified by Moon.

### 2.5.3 Allais effect as evidence for large values of gravitational Planck constant?

One can represent rather general counter arguments against the models based on  $Z^0$  conductivity and gravitational screening if one takes seriously the puzzling experimental findings concerning frequency change.

1. Allais effect identified as a rotation of oscillation plane seems to be established and seems to be present always and can be understood in terms of torque implying limiting oscillation plane.
2. During solar eclipses Allais effect however becomes much stronger. According to Olenici's experimental work the effect appears always when massive objects form collinear structures.
3. The behavior of the change of oscillation frequency seems puzzling. The sign of the frequency increment varies from experiment to experiment and its magnitude varies within five orders of magnitude.

#### What one can conclude about general pattern for $\Delta f/f$ ?

The above findings allow to make some important conclusions about the nature of Allais effect.

1. Some genuinely new dynamical effect should take place when the objects are collinear. If gravitational screening would cause the effect the frequency would always grow but this is not the case.
2. If stellar objects and also ring like dark matter structures possibly assignable to their orbits are  $Z^0$  conductors, one obtains screening effect by polarization and for the ring like structure the resulting effectively 2-D dipole field behaves as  $1/\rho^2$  so that there are hopes of obtaining large screening effects and if the  $Z^0$  charge of pendulum is allow to have both signs, one might hope of being to able to explain the effect. It is however difficult to understand why this effect should become so strong in the collinear case.
3. The apparent randomness of the frequency change suggests that interference effect made possible by the gigantic value of gravitational Planck constant is in question. On the other hand, the dependence of  $\Delta g/g$  on pendulum suggests a breaking of Equivalence Principle. It however turns out that the variation of the distances of the pendulum to Sun and Moon can explain the experimental findings since the pendulum turns out to act as a sensitive gravitational interferometer. An apparent breaking of Equivalence Principle could result if the effect is partially caused by genuine gauge forces, say dark classical  $Z^0$  force, which can have arbitrarily long range in TGD Universe.
4. If topological light rays (MEs) provide a microscopic description for gravitation and other gauge interactions one can envision these interactions in terms of MEs extending from Sun/Moon radially to pendulum system. What comes in mind that in a collinear configuration the signals along S-P MEs and M-P MEs superpose linearly so that amplitudes are

summed and interference terms give rise to an anomalous effect with a very sensitive dependence on the difference of S-P and M-P distances and possible other parameters of the problem. One can imagine several detailed variants of the mechanism. It is possible that signal from Sun combines with a signal from Earth and propagates along Moon-Earth ME or that the interferences of these signals occurs at Earth and pendulum.

5. Interference suggests macroscopic quantum effect in astrophysical length scales and thus gravitational Planck constants given by  $\hbar_{gr} = GMm/v_0$ , where  $v_0 = 2^{-11}$  is the favored value, should appear in the model. Since  $\hbar_{gr} = GMm/v_0$  depends on both masses this could give also a sensitive dependence on mass of the pendulum. One expects that the anomalous force is proportional to  $\hbar_{gr}$  and is therefore gigantic as compared to the effect predicted for the ordinary value of Planck constant.

### Model for interaction via gravitational MEs with large Planck constant

Restricting the consideration for simplicity only gravitational MEs, a concrete model for the situation would be as follows.

1. The picture based on topological light rays suggests that the gravitational force between two objects  $M$  and  $m$  has the following expression

$$\begin{aligned} F_{M,m} &= \frac{GMm}{r^2} = \int |S(\lambda, r)|^2 p(\lambda) d\lambda \\ p(\lambda) &= \frac{\hbar_{gr}(M, m) 2\pi}{\lambda} \quad , \quad \hbar_{gr} = \frac{GMm}{v_0(M, m)} \quad . \end{aligned} \quad (2.5.11)$$

$p(\lambda)$  denotes the momentum of the gravitational wave propagating along ME.  $v_0$  can depend on  $(M, m)$  pair. The interpretation is that  $|S(\lambda, r)|^2$  gives the rate for the emission of gravitational waves propagating along ME connecting the masses, having wave length  $\lambda$ , and being absorbed by  $m$  at distance  $r$ .

2. Assume that  $S(\lambda, r)$  has the decomposition

$$\begin{aligned} S(\lambda, r) &= R(\lambda) \exp[i\Phi(\lambda)] \frac{\exp[ik(\lambda)r]}{r} \quad , \\ \exp[ik(\lambda)r] &= \exp[ip(\lambda)r/\hbar_{gr}(M, m)] \quad , \\ R(\lambda) &= |S(\lambda, r)| \quad . \end{aligned} \quad (2.5.12)$$

The phases  $\exp(i\Phi(\lambda))$  might be interpreted in terms of scattering matrix. The simplest assumption is  $\Phi(\lambda) = 0$  turns out to be consistent with the experimental findings. The substitution of this expression to the above formula gives the condition

$$\int |R(\lambda)|^2 \frac{d\lambda}{\lambda} = v_0 \quad . \quad (2.5.13)$$

Consider now a model for the Allais effect based on this picture.

1. In the non-collinear case one obtains just the standard Newtonian prediction for the net forces caused by Sun and Moon on the pendulum since  $Z_{S,P}$  and  $Z_{M,P}$  correspond to non-parallel MEs and there is no interference.

2. In the collinear case the interference takes place. If interference occurs for identical momenta, the interfering wavelengths are related by the condition

$$p(\lambda_{S,P}) = p(\lambda_{M,P}) . \quad (2.5.14)$$

This gives

$$\frac{\lambda_{M,P}}{\lambda_{S,P}} = \frac{\hbar_{M,P}}{\hbar_{S,P}} = \frac{M_M v_0(S,P)}{M_S v_0(M,P)} . \quad (2.5.15)$$

3. The net gravitational force is given by

$$\begin{aligned} F_{gr} &= \int |Z(\lambda, r_{S,P}) + Z(\lambda/x, r_{M,P})|^2 p(\lambda) d\lambda \\ &= F_{gr}(S,P) + F_{gr}(M,P) + \Delta F_{gr} , \\ \Delta F_{gr} &= 2 \int \text{Re} [S(\lambda, r_{S,P}) \bar{S}(\lambda/x, r_{M,P})] \frac{\hbar_{gr}(S,P) 2\pi}{\lambda} d\lambda , \\ x &= \frac{\hbar_{S,P}}{\hbar_{M,P}} = \frac{M_S v_0(M,P)}{M_M v_0(S,P)} . \end{aligned} \quad (2.5.16)$$

Here  $r_{M,P}$  is the distance between Moon and pendulum. The anomalous term  $\Delta F_{gr}$  would be responsible for the Allais effect and change of the frequency of the oscillator.

4. The anomalous gravitational acceleration can be written explicitly as

$$\begin{aligned} \Delta a_{gr} &= 2 \frac{GM_S}{r_S r_M} \frac{1}{v_0(S,P)} \times I , \\ I &= \int R(\lambda) R(\lambda/x) \cos \left[ \Phi(\lambda) - \Phi(\lambda/x) + 2\pi \frac{(y_S r_S - x y_M r_M)}{\lambda} \right] \frac{d\lambda}{\lambda} , \\ y_M &= \frac{r_{M,P}}{r_M} , \quad y_S = \frac{r_{S,P}}{r_S} . \end{aligned} \quad (2.5.17)$$

Here the parameter  $y_M$  ( $y_S$ ) is used express the distance  $r_{M,P}$  ( $r_{S,P}$ ) between pendulum and Moon (Sun) in terms of the semi-major axis  $r_M$  ( $r_S$ ) of Moon's (Earth's) orbit. The interference term is sensitive to the ratio  $2\pi(y_S r_S - x y_M r_M)/\lambda$ . For short wave lengths the integral is expected to not give a considerable contribution so that the main contribution should come from long wave lengths. The gigantic value of gravitational Planck constant and its dependence on the masses implies that the anomalous force has correct form and can also be large enough.

5. If one poses no boundary conditions on MEs the full continuum of wavelengths is allowed. For very long wave lengths the sign of the cosine terms oscillates so that the value of the integral is very sensitive to the values of various parameters appearing in it. This could explain random looking outcome of experiments measuring  $\Delta f/f$ . One can also consider the possibility that MEs satisfy periodic boundary conditions so that only wave lengths  $\lambda_n = 2r_S/n$  are allowed: this implies  $\sin(2\pi y_S r_S/\lambda) = 0$ . Assuming this, one can write the magnitude of the anomalous gravitational acceleration as

$$\begin{aligned}\Delta a_{gr} &= \frac{2GM_S}{r_{S,P}r_{M,P}} \times \frac{1}{v_0(S,P)} \times I \ , \\ I &= \sum_{n=1}^{\infty} R\left(\frac{2r_{S,P}}{n}\right)R\left(\frac{2r_{S,P}}{nx}\right)(-1)^n \cos \left[ \Phi(n) - \Phi(xn) + n\pi \frac{xy_M}{y_S} \frac{r_M}{r_S} \right] \ .\end{aligned}\tag{2.5.18}$$

If  $R(\lambda)$  decreases as  $\lambda^k$ ,  $k > 0$ , at short wavelengths, the dominating contribution corresponds to the lowest harmonics. In all terms except cosine terms one can approximate  $r_{S,P}$  resp.  $r_{M,P}$  with  $r_S$  resp.  $r_M$ .

6. The presence of the alternating sum gives hopes for explaining the strong dependence of the anomaly term on the experimental arrangement. The reason is that the value of  $xyr_M/r_S$  appearing in the argument of cosine is rather large:

$$\frac{xy_M}{y_S} \frac{r_M}{r_S} = \frac{y_M}{y_S} \frac{M_S}{M_M} \frac{r_M}{r_S} \frac{v_0(M,P)}{v_0(S,P)} \simeq 6.95671837 \times 10^4 \times \frac{y_M}{y_S} \times \frac{v_0(M,P)}{v_0(S,P)} \ .$$

The values of cosine terms are very sensitive to the exact value of the factor  $M_S r_M / M_M r_S$  and the above expression is probably not quite accurate value. As a consequence, the values and signs of the cosine terms are very sensitive to the values of  $y_M/y_S$  and  $\frac{v_0(M,P)}{v_0(S,P)}$ .

The value of  $y_M/y_S$  varies from experiment to experiment and this alone could explain the high variability of  $\Delta f/f$ . The experimental arrangement would act like interferometer measuring the distance ratio  $r_{M,P}/r_{S,P}$ . Hence it seems that the condition

$$\frac{v_0(S,P)}{v_0(M,P)} \neq \text{const.}\tag{2.5.19}$$

implying breaking of Equivalence Principle is not necessary to explain the variation of the sign of  $\Delta f/f$  and one can assume  $v_0(S,P) = v_0(M,P) \equiv v_0$ . One can also assume  $\Phi(n) = 0$ .

### Scaling law

The assumption of the scaling law

$$R(\lambda) = R_0 \left( \frac{\lambda}{\lambda_0} \right)^k\tag{2.5.20}$$

is very natural in light of conformal invariance and masslessness of gravitons and allows to make the model more explicit. With the choice  $\lambda_0 = r_S$  the anomaly term can be expressed in the form

$$\begin{aligned}\Delta a_{gr} &\simeq \frac{GM_S}{r_S r_M} \frac{2^{2k+1}}{v_0} \left( \frac{M_M}{M_S} \right)^k R_0(S,P) R_0(M,P) \times \sum_{n=1}^{\infty} \frac{(-1)^n}{n^{2k}} \cos [\Phi(n) - \Phi(xn) + n\pi K] \ , \\ K &= x \times \frac{r_M}{r_S} \times \frac{y_M}{y_S} \ .\end{aligned}\tag{2.5.21}$$

The normalization condition of Eq. 4.3.42 reads in this case as

$$R_0^2 = v_0 \times \frac{1}{2\pi \sum_n \left(\frac{1}{n}\right)^{2k+1}} = \frac{v_0}{\pi \zeta(2k+1)} \ .\tag{2.5.22}$$



Note the shorthand  $v_0(S/M, P) = v_0$ . The anomalous gravitational acceleration is given by

$$\begin{aligned}\Delta a_{gr} &= \sqrt{\frac{v_0(M, P)}{v_0(S, P)} \frac{GM_S}{r_S^2}} \times XY \times \sum_{n=1}^{\infty} \frac{(-1)^n}{n^{2k}} \cos[\Phi(n) - \Phi(xn) + n\pi K] , \\ X &= 2^{2k} \times \frac{r_S}{r_M} \times \left(\frac{M_M}{M_S}\right)^k , \\ Y &= \frac{1}{\pi \sum_n \left(\frac{1}{n}\right)^{2k+1}} = \frac{1}{\pi \zeta(2k+1)} .\end{aligned}\quad (2.5.23)$$

It is clear that a reasonable order of magnitude for the effect can be obtained if  $k$  is small enough and that this is essentially due to the gigantic value of gravitational Planck constant.

The simplest model consistent with experimental findings assumes  $v_0(M, P) = v_0(S, P)$  and  $\Phi(n) = 0$  and gives

$$\begin{aligned}\frac{\Delta a_{gr}}{g \cos(\Theta)} &= \frac{GM_S}{r_S^2 g} \times XY \times \sum_{n=1}^{\infty} \frac{(-1)^n}{n^{2k}} \cos(n\pi K) , \\ X &= 2^{2k} \times \frac{r_S}{r_M} \times \left(\frac{M_M}{M_S}\right)^k , \\ Y &= \frac{1}{\pi \sum_n \left(\frac{1}{n}\right)^{2k+1}} = \frac{1}{\pi \zeta(2k+1)} , \\ K &= x \times \frac{r_M}{r_S} \times \frac{y_M}{y_S} , \quad x = \frac{M_S}{M_M} .\end{aligned}\quad (2.5.24)$$

### Numerical estimates

To get a numerical grasp to the situation one can use  $M_S/M_M \simeq 2.71 \times 10^7$ ,  $r_S/r_M \simeq 389.1$ , and  $(M_S r_M / M_M r_S) \simeq 1.74 \times 10^4$ . The overall order of magnitude of the effect would be

$$\begin{aligned}\frac{\Delta g}{g} &\sim XY \times \frac{GM_S}{R_S^2 g} \cos(\Theta) , \\ \frac{GM_S}{R_S^2 g} &\simeq 6 \times 10^{-4} .\end{aligned}\quad (2.5.25)$$

The overall magnitude of the effect is determined by the factor  $XY$ .

1. For  $k = 0$  the normalization factor is proportional to  $1/\zeta(1)$  and diverges and it seems that this option cannot work.
2. The table below gives the predicted overall magnitudes of the effect for  $k = 1, 2/2$  and  $1/4$ .

k	1	1/2	1/4
$\frac{\Delta g}{g \cos(\Theta)}$	$1.1 \times 10^{-9}$	$4.3 \times 10^{-6}$	$1.97 \times 10^{-4}$

For  $k = 1$  the effect is too small to explain even the findings of [E19] since there is also a kinematic reduction factor coming from  $\cos(\Theta)$ . Therefore  $k < 1$  suggesting fractal behavior is required. For  $k = 1/2$  the effect is of same order of magnitude as observed by Allais. The alternating sum equals in a good approximation to  $-0.693$  for  $y_S/y_M = 1$  so that it is not possible to explain the finding  $\Delta f/f \simeq 5 \times 10^{-4}$  of Jeverdan.

3. For  $k = 1/4$  the expression for  $\Delta a_{gr}$  reads as

$$\frac{\Delta a_{gr}}{g \cos(\Theta)} \simeq 1.97 \times 10^{-4} \sum_{n=1}^{\infty} \frac{(-1)^n}{n^{1/2}} \cos(n\pi K) \quad ,$$

$$K = \frac{y_M}{y_S} u \quad , \quad u = \frac{M_S}{M_M} \frac{r_M}{r_S} \simeq 6.95671837 \times 10^4 \quad . \quad (2.5.26)$$

The sensitivity of cosine terms to the precise value of  $y_M/y_S$  gives good hopes of explaining the strong variation of  $\Delta f/f$  and also the findings of Jeverdan. Numerical experimentation indeed shows that the sign of the cosine sum alternates and its value increases as  $y_M/y_S$  increases in the range  $[1, 2]$ .

The eccentricities of the orbits of Moon *resp.* Earth are  $e_M = .0549$  *resp.*  $e_E = .017$ . Denoting semimajor and semiminor axes by  $a$  and  $b$  one has  $\Delta = (a - b)/a = 1 - \sqrt{1 - e^2}$ .  $\Delta_M = 15 \times 10^{-4}$  *resp.*  $\Delta_E = 1.4 \times 10^{-4}$  characterizes the variation of  $y_M$  *resp.*  $y_M$  due to the non-circularity of the orbits of Moon *resp.* Earth. The ratio  $R_E/r_M = .0166$  characterizes the range of the variation  $\Delta y_M = \Delta r_{M,P}/r_M \leq R_E/r_M$  due to the variation of the position of the laboratory. All these numbers are large enough to imply large variation of the argument of cosine term even for  $n = 1$  and the variation due to the position at the surface of Earth is especially large.

The duration of full eclipse is of order 8 minutes which corresponds to angle  $\phi = \pi/90$  and at equator roughly to a  $\Delta y_N = (\sqrt{r_M^2 + R_E^2 \sin^2(\pi/90)} - r_M)/r_M \simeq (\pi/90)^2 R_E^2 / 2r_M^2 \simeq 1.7 \times 10^{-7}$ . Thus the change of argument of  $n = 1$  cosine term during full eclipse is of order  $\Delta\Phi = .012\pi$  at equator. The duration of the eclipse itself is of order two 2 hours giving  $\Delta y_M \simeq 3.4 \times 10^{-5}$  and the change  $\Delta\Phi = 2.4\pi$  of the argument of  $n = 1$  cosine term.

### 2.5.4 Could $Z^0$ force be present?

One can understand the experimental results without a breaking of Equivalence Principle if the pendulum acts as a quantum gravitational interferometer. One cannot exclude the possibility that there is also a dependence on pendulum. In this case one would have a breaking of Equivalence Principle, which could be tested using several penduli in the same experimental arrangement. The presence of  $Z^0$  force could induce an apparent breaking of Equivalence Principle. The most plausible option is  $Z^0$  MEs with large Planck constant. One can consider also an alternative purely classical option, which does not involve large values of Planck constant.

#### Could purely classical $Z^0$ force allow to understand the variation of $\Delta f/f$ ?

In the earlier model of the Allais effect (see Appendix) I proposed that the classical  $Z^0$  force could be responsible for the effect. TGD indeed predicts that any object with gravitational mass must have non-vanishing em and  $Z^0$  charges but leaves their magnitude and sign open.

1. If both Sun, Earth, and pendulum have  $Z^0$  charges, one might even hope of understanding why the sign of the outcome of the experiment varies since the ratio of  $Z^0$  charge to gravitational mass and even the sign of  $Z^0$  charge of the pendulum might vary. Constant charge-to-mass ratio is of course the simplest hypothesis so that only an effective scaling of gravitational constant would be in question. A possible test is to use several penduli in the same experiment and find whether they give rise to same effect or not.
2. If Moon and Earth are  $Z^0$  conductors, a  $Z^0$  surface charge cancelling the tangential component of  $Z^0$  force at the surface of Earth is generated and affects the vertical component of the force experienced by the pendulum. The vertical component of  $Z^0$  force is  $2F_Z \cos(\theta)$  and thus proportional to  $\cos(\Theta)$  as also the effective screening force below the shadow of Moon during solar eclipse. When Sun is in a vertical direction, the induced dipole contribution doubles the radial  $Z^0$  force near surface and the effect due to the gravitational screening would be maximal. For Sun in horizon there would be no  $Z^0$  force and gravitational tidal effect of Sun would vanish in the first order so that over all anomalous effect would be smallest possible: for a full screening  $\Delta f/f \simeq \Delta g^2/4g^2 \simeq 4.5 \times 10^{-8}$  would be predicted. One

might hope that the opposite sign of gravitational and  $Z^0$  contributions could be enough to explain the varying sign of the overall effect.

3. It seems necessary to have a screening effect associated with gravitational force in order to understand the rapid variation of the effect during the eclipse. The fact that the maximum effect corresponds to a maximum gravitational screening suggests that it is present and determines the general scale of variation for the effect. If the maximal  $Z^0$  charge of the pendulum is such that  $Z^0$  force is of the same order of magnitude as the maximal screening of the gravitational force and of opposite sign (that is attractive), one could perhaps understand the varying sign of the effect but the effect would develop continuously and begin before the main eclipse. If the sign of  $Z^0$  charge of pendulum can vary, there is no difficulty in explaining the varying sign of the effect. An interesting possibility is that Moon, Sun and Earth have dark matter halos so that also gravitational screening could begin before the eclipse. The real test for the effect would come from tidal effects unless one can guarantee that the pendulum is  $Z^0$  neutral or its  $Z^0$  charge/mass ratio is always the same.
4. As noticed also by Allais, Newtonian theory does not give a satisfactory account of the tidal forces and there is possibility that tides give a quantitative grasp on situation. If Earth is  $Z^0$  conductor tidal effects should be determined mainly by the gravitational force and modified by its screening whereas  $Z^0$  force would contribute mainly to the pressure waves accompanying the shadows of Moon and Sun. The sign and magnitude of pressure waves below Sun and Moon could give a quantitative grasp of  $Z^0$  forces of Sun and Moon.  $Z^0$  surface charge would have opposite signs at the opposite sides of Earth along the line connecting Earth to Moon *resp.* Sun and depending on sign of  $Z^0$  force the screening and  $Z^0$  force would tend to amplify or cancel the net anomalous effect on pressure.
5. A strong counter argument against the model based on  $Z^0$  force is that collinear configurations are reached in continuous manner from non-collinear ones in the case of  $Z^0$  force and the fact that gravitational screening does not conform with the varying sign of the discontinuous effect occurring during the eclipse. It would seem that the effect in question is more general than screening and perhaps more like quantum mechanical interference effect in astrophysical length scale.

### Could $Z^0$ MEs with large Planck constant be present?

The previous line of arguments for gravitational MEs generalizes in a straightforward manner to the case of  $Z^0$  force. Generalizing the expression for the gravitational Planck constant one has  $\hbar_{Z^0} = g_Z^2 Q_Z(M) Q_Z(m) / v_0$ . Assuming proportionality of  $Z^0$  charge to gravitational mass one obtains formally similar expression for the  $Z^0$  force as in previous case. If  $Q_Z/M$  ratio is constant, Equivalence Principle holds true for the effective gravitational interaction if the sign of  $Z^0$  charge is fixed. The breaking of Equivalence Principle would come naturally from the non-constancy of the  $v_0(S, P) / v_0(M, P)$  ratio also in the recent case. The variation of the sign of  $\Delta f / f$  would be explained in a trivial manner by the variation of the sign of  $Z^0$  charge of pendulum but this explanation is not favored by Occam's razor.

## 2.6 Dark $Z^0$ force in astrophysical length scales

The findings of Shnoll give support for the predicted importance of dark  $Z^0$  force in astrophysical length scales.

### 2.6.1 The regularities in radio active decay rates linked to astrophysical cycles

Russian scientists have discovered regularities in the rates of radio active, chemical and biochemical processes linked to astrophysical periodicities. The observations of Shnoll and his collaborators summarizing work of forty years, were published for a couple years ago in a respected Russian science journal [E20] , [E20] , but have been greeted with silence in media. It took two years before

I learned from the discovery (I am grateful for Prof. Adrian Klein for informing me about the work). This silence strengthens further my impression that theoretical physicists have concluded that superstrings provide the final truth about everything above and below Planck length scale, and have therefore decided to turn their back to the empirical science. Also the fact that the discovery of Shnoll and his collaborators is in strong a conflict with the basic dogma of reductionism which is a basic tenet of standard physics including superstring models, might explain the peculiar silence. Certainly, at the times of Einstein empirical discovery of this caliber would have been a major scientific event.

### Dark $Z^0$ force as explanation of the observations

The observations of Shnoll and collaborators can be summarized by two statements.

1. The rate distributions for radio active decays and chemical and biochemical processes do not converge to single bell curve as suggested by quantum randomness plus standard model but to distributions which have several pronounced peaks.
2. The shapes of the rate curves seem to be similar to widely different reactions (radio-active decays, chemical and biochemical processes) but they fluctuate with time and fluctuation periods correspond to various astrophysical periods: day, month, year,...

The latter observation suggests strongly that there is an astrophysical factor, presumably some unidentified long range force, involved. In standard physics gravitational force is the only candidate but the effects caused by the gravitational force are quite too weak. In TGD situation is different and the observations of Shnoll provide an additional piece to the picture constructed during the last decade.

1. TGD predicts that all massive bodies necessarily generate long range Coulombic dark  $Z^0$  force. This is mathematical necessity: only the strength of this force can vary. This interaction is instantaneous: entire system behaves like single coherent whole, a comparison with a biological organism might not be far fetched. This force is however extremely weak in astrophysical length scales. TGD predicts also "massless extremals" (MEs), which can also carry classical  $Z^0$  fields. Classical signals propagating with light velocity over cosmic distances would be in question now. There is no attenuation since essentially a radiation propagating in a wave guide is in question. Since these signals propagate along their own space-time sheets, the interaction with the cosmic microwave background does not attenuate them. The absence of dispersion means that information is preserved during the propagation of the classical field. The nondeterminism of the light-like vacuum current associated with ME at a given point of ME allows arbitrary pulse shapes and makes MEs optimal for the coding of information. These and some other properties of MEs explain with MEs are in key role in TGD inspired theory of consciousness and life [K29].
2. p-Adic fractality suggests [K23] that the dark  $Z^0$  charge of a macroscopic object per volume defined by the p-adic length scale is essentially same irrespective of its size. This means that small objects have the highest  $Z^0$  charge per mass ratio and respond to the classical  $Z^0$  fields most intensely. The objects in the meter scale still have  $Z^0$  charge densities making possible small effects. For astrophysical objects like Earth  $Z^0$  charge is so small that it has no appreciable effects on the motion of Earth in  $Z^0$  field of Sun. Somewhat surprisingly, dark  $Z^0$  force is predicted to become important already in nuclear physics length scale. Dark  $Z^0$  force is expected to be especially important in the length scale range 10 nm-2.5  $\mu\text{m}$  containing the p-adic length scales of four Gaussian Mersennes.
3. Classical  $Z^0$  force predicts variations in the rates of the radio active decays since it ultimately couples with exotic quarks of atomic nuclei at the long color bonds connecting different nucleons. This happens if the color bond is charged and thus also possesses weak gauge charge. Thus the coupling of matter to astrophysical  $Z^0$  MEs could explain the observations of Shnoll and collaborators just as it explains the findings of Allais.

It has been already earlier found that the beta decay of tritium (neutron decays to proton+electron+ antineutrino) exhibits anomaly when the energy of the neutrino is very small [K71]

. Also this decay exhibits periodic variations with several periods: one of them is year. This inspired the assumption that Earth's orbit is surrounded by a dark neutrino belt which has density which is not constant along the orbit and causes the effects.

4. The fluctuation of also chemical and biochemical reaction rates with the astrophysical periods lends a strong support for the hypothesis that  $Z^0$  force is a crucial element in chemical and biological systems. For instance, classical  $Z^0$  force explains chirality selection which is a mystery in standard physics since huge parity breaking effect is in question [K23]. In TGD inspired theory of consciousness  $Z^0$  force is in a key role: perhaps ZEG might be some day regarded as a basic carrier of information about contents of consciousness besides EEG. The quantum physics behind hearing involves what I have used to call "cognitive neutrino pairs" and dark  $Z^0$  force in the length scale of the cell membrane [K60]. Also dark neutrino super conductivity could define an important piece in the jigsaw of consciousness. Atoms and ions of condensed matter with anomalous weak charges can also behave as  $Z^0$  super conductors and  $Z^0$  magnetic cyclotron frequencies could represent important ZEG frequencies.
5. One must notice that also the spectrum for Planck constants could give a spectrum of rates due to the fact that higher order corrections to the decay rates depend on Planck constant assuming that lowest order term corresponds to  $\hbar^0$ , the classical approximation.

### Several process rates and many-sheeted space-time

How to explain the fact that there are several average process rates leading to the replacement of bell curve with a many-peaked curve? One can imagine several explanations. The essential element of explanation is that classical  $Z^0$  forces of both local and astrophysical origin affect the rates and that  $Z^0$  field has different strengths in different parts of the system.

The first possibility is that the internal  $Z^0$  forces vary in different parts of system. Second possibility is that external  $Z^0$  force has effectively several strengths: this is quite possible in the many-sheeted space-time. The space-time sheets at which processes occur, can be 'glued' by topological sum operation to a larger space-time sheet. If this larger space-time sheet is not always the same, the external  $Z^0$  force varies according to which sheet the topological condensation occurs on. This gives rise to many-peaked rate curve. This many-peaked structure would be universal and highly independent of a type of process studied. Besides the p-adic length scale  $L_e(k = 169)$ , which corresponds to the space-time sheet of neutrinos usually, the space-time sheets characterized by the scaled up electron Compton lengths  $L_e(k) = \sqrt{5}L(k)$ ,  $k = 151, 157, 163, 167$ , varying between 10 nanometers and 2.6 micrometers, are especially interesting in this respect since they correspond to the counterparts of Mersenne primes for Gaussian primes (having the form  $(1 + i)^k - 1$ ) and are predicted to be fundamental biological length scales. Note also that the "cognitive antineutrinos" are assumed to be associated with  $k = 151$  space-time sheet in TGD inspired quantum model of hearing. Note that these four p-adic length scales might correlate directly with qualitatively different levels in the evolution of life.

### Bio-control over cosmic distances?

What is interesting is that classical  $Z^0$  force might make possible bio-control over cosmic distances. The p-adic length scales associated with Gaussian Mersennes are in length scale 10 nm-2.5  $\mu\text{m}$  suggests that objects with cell size have the highest  $Z^0$  charge per mass ratio. Coherently changing cosmic  $Z^0$  fields could simultaneously induce effects on bio-matter in cosmic scales: erratic interpretation of these effects as signals would lead to a conclusion that signals have propagated with super-luminal velocity. Massless extremals (MEs) accompanied by classical  $Z^0$  fields might make possible communication and control. Cell size objects (or possibly objects with sizes between cell membrane thickness and cell size) would serve as optimal receivers. One can also speculate with the possible connection between the ubiquitous  $1/f$  noise and classical  $Z^0$  fields associated with MEs of possibly cosmic size [K50, K51]. The work done to detect signals sent by extra-terrestrial civilizations has not yielded positive results hitherto. A possible explanation is that electromagnetic signals are not used for communication purposes by advanced civilizations. One can consider also the possibility that these signals are coded into classical  $Z^0$  fields propagating along MEs and that the mysterious  $1/f$  noise contains these signals.

### 2.6.2 Torsion fields or $Z^0$ fields

Torsion fields have been used to explain the anomalous effects related to spinning systems, in particular breaking of parity. In general relativity framework the coupling of torsion fields is quite too weak to explain these anomalies. Long ranged weak fields created by dark matter, in particular  $Z^0$  field, can however explain these effects.

#### The concept of torsion field

The common denominator of most anomalous effects is the presence of spinning objects. This naturally led to the idea that the so called torsion field coupling to spin density could provide an explanation for the anomalous effects. In order to avoid confusion it is useful to notice that the concept of torsion has several meanings.

1. The concept of torsion and its connection with spin was introduced already by E. Cartan. It is possible to introduce torsion into Einstein's theory of gravitation as a dynamical pseudo vector field defined as the tensor dual for the antisymmetrized Christoffel symbols for non-metric connection [H28, H51, H30, H54, H24]. This however requires generalizing Einstein's theory of gravitation based on metric connection having vanishing torsion. It turns that spin-torsion interaction is practically a spin-spin contact interaction and that torsion fields do not propagate in this theory. The coupling between torsion and spin is extremely weak: about 27 orders of magnitude weaker than the constant of gravitational interactions. Also a large number of nonlinear torsion theories have appeared: for instance, the torsion theory of [H52] [H52] in which the coupling constant of spin torsion interactions is of order  $10^{-5} - 10^{-6}$ . In TGD framework torsion in this sense is not possible since TGD relies on metric geometry.
2. Topological torsion can be defined as a topological current defined by the inner product  $E \cdot B$  of electric and magnetic fields ("instanton density") proportional to the divergence of the axial vector density  $T^\mu = \epsilon^{\mu\alpha\beta\gamma} A_\alpha F_{\beta\gamma}$  [B3]. The integral of this quantity over a closed 3-surface is topological invariant of em field. Topological torsion is obviously not an independent dynamical degree of freedom. In TGD the vanishing of the invariant implies that  $E$  and  $B$  are nonorthogonal in the interior of the integration volume and this in turn means that classical  $Z^0$  field accompanies em field and also that parity breaking occurs due to the axial couplings of  $Z^0$  field to fermions. The reason for this is very simple: induced gauge field is Abelian only if the  $CP_2$  projection of the space-time surface is 2-dimensional. This in turn automatically implies that  $E$  and  $B$  are orthogonal for all induced gauge fields so that instanton density vanishes. Thus torsion becomes a signature for the presence of classical  $Z^0$  fields in TGD framework.

#### The effects attributed to torsion fields can be explained in terms of classical $Z^0$ fields

Various experimental methods to detect torsion fields and even communication methods based on the effects of torsion fields on matter are reported [H38]. There is also a claims for evidence about nontrivial effects of torsion fields on living matter, admittedly some of them sound rather bizarre and must be taken with a big grain of salt. The experimental characteristics described in [H38] are consistent with the identification of the torsion fields with classical  $Z^0$  fields.  $Z^0$  classical fields are indeed in key role in TGD inspired theory of consciousness. Therefore one should be open minded in judging the reality of the claimed effects of torsion on living matter.

1. Torsion fields are generated by classical spin. If material object spins in stationary manner, torsion field is static. Same is true for the  $Z^0$  magnetic field. Also the description of [H38] for the topology of the torsion field generated by spinning object resembles dipole magnetic field and nontrivial gyroscopic effects result when object spins in non-stationary manner. This is true also for  $Z^0$  fields: nonstationary rotation generates by Faraday's induction law rotational  $Z^0$  electric fields. In TGD large gravitational effects are possible since induced metric and classical gauge fields can both expressed in terms of  $CP_2$  coordinates and the constraint of being imbeddable to  $M_+^4 \times CP_2$  generates strong constraint forces.

2. According to [H38], some materials are known to serve as shields against torsion fields. In the similar manner  $Z^0$  diamagnets serve as shields against  $Z^0$  magnetic fields. The shielding is expected to occur in the space-time sheet labelled by the p-adic prime  $p \simeq 2^k$ ,  $k = 169$ , which according to TGD inspired model of condensed matter, is neutrino super conductor of type I. Note that this space-time sheet corresponds to the space-time sheet of epithelial sheets consisting of two cell layers and is fundamental in TGD based theory of consciousness.
3. Torsion fields are predicted to be generated by any spinning material structure [H38]. For  $Z^0$  magnetic fields in condensed matter would occur if nuclei of condensed matter carry anomalous  $Z^0$  charges due to the charging of color bonds having exotic quarks at their ends. The quarks would couple to scaled down copies of weak bosons with weak length scale of order atomic radius.
4. Spin polarization creates torsion fields [H38] and torsion fields affect spin structure of matter. This is suggested to explain the "magnetization of water" [H38], that is the effect of ordinary magnet on biological activity of distilled water, which is diamagnetic substance. As already noticed "torsion fields" are reported to have biological effects (for references see [H38]). According to the model of [K23] water the anomalous properties of water are essentially to the dark nuclear  $Z^0$  force and it would not be surprising if this kind of effects would occur.
5. One should have a good explanation for why classical  $Z^0$  fields have not been observed until during last decades. That dark matter generates these fields, is certainly such an explanation.
6. Faraday's law of induction holds true for the classical  $Z^0$  fields and effects revealing non-electromagnetic induction effect give support for the TGD based picture. One effect of this kind relates to a configuration involving two parallel conducting disks on top of each other [H36]. The lower disk rotates. If the angular velocity of the lower disk is gradually increased, the disk above it begins to rotate in opposite direction so that friction cannot cause this effect.  

A possible explanation is based on Faraday's induction law. When the rotation velocity increases, the static  $Z^0$  magnetic field changes and gives rise to rotational  $Z^0$  electric field, the flow lines of which circulate around the rotation axis. This in turn implies classical  $Z^0$  Coulomb force on nuclei of the disk (assumed to have dark weak charge) accelerating them in opposite directions. The rotation of nucleons is perceived as macroscopic rotation. By the principle of least action the direction of rotation must be such that it generates  $Z^0$  magnetic field in direction opposite to that of the original field and this means that upper disk begins to rotate in direction opposite to that of the lower disk. It is not clear whether torsion field picture could explain this effect.
7. The weight loss of a spinning gyroscope involves strong parity breaking effect and the parity breaking couplings of the classical  $Z^0$  field readily explain the symmetry breaking. To explain the effect in picture based on torsion fields would require ad hoc assumptions about the coupling of torsion field to classical spin.

## 2.7 How to test the presence of the $Z^0$ force in micrometer-millimeter length scale range?

p-Adic fractality suggests that the density of dark  $Z^0$  charge scales as  $1/L_p^3$ . The model for atomic nuclei predicts that the density of dark  $Z^0$  charge is few units per atomic volume in condensed matter. This predicts that the  $Z^0$  force is comparable to the gravitational force below length scale of order 2-20  $\mu\text{m}$ .

In general, the values of  $G$  determined using Cavendish experiment have unexpectedly large range of variation although the accuracies of individual experiments are rather high. Variations of .01 – 1 per cent are present [E3]. There is also Cavendish experiment performed by Kruse [E25] determining gravitational constant using small rigidly connected metal spheres forming torsion pendulum. The measured value of the gravitational constant was found to be 89 per cent of the standard value! Since  $Z^0$  force between small masses is effectively eliminated in classical Cavendish

experiment,  $Z^0$  force cannot explain these anomalies. TGD based explanation for discrepancies could be based on some other mechanism, perhaps on the redistribution of the gravitational flux of the big masses leading to effective change of the gravitational mass.

Wuppertal group [E3] has determined gravitational constant by measuring the distance between two gravitational penduli. This experiment is sensitive to classical  $Z^0$  force between the small test masses and two variants of this experiment able to test the presence of the classical  $Z^0$  force are discussed.

One can also consider much simpler experiment determining directly the effective gravitational force between two gravitational penduli. In the first stage of the experiment the distance from a fixed reference point to the gravitational pendulum is measured. Then second identical gravitational pendulum is introduced on the line connecting the reference point and the first pendulum and the distance is measured again. The difference of these distances allows to deduce the value of the effective gravitational constant.

### 2.7.1 Scaling law for dark $Z^0$ charges

#### p-Adic length scale hypothesis

p-Adic length scale hypothesis states that p-adic primes which correspond to with  $p \simeq 2^k$ ,  $k$  power of prime are physically preferred ones. The table below gives the list of p-adic length scales relevant for condensed matter physics. Note that the length scales are determined only up to some numerical constant. The fixing of  $L_e(151)$  to be the thickness of cell membrane about  $10^{-8}$  meters is promising physically sensical manner to fix the overall scale factor uniquely.

k	127	131	137	139	149
$L_p/10^{-10}m$	.020	.082	.65	1.3	42.0
k	151	157	163	167	169
$L_p/10^{-7}m$	.083	.67	5.3	21	42
k	173	179	181	191	193
$L_p/10^{-3}m$	.0017	.14	.28	8.9	17.8

Table 1. p-Adic length scales  $L_p = 2^{k-127}L_e(127)$ ,  $p \simeq 2^k$ ,  $L_e(127) \equiv \frac{\pi\sqrt{5+Y}}{m_e}$ ,  $Y = .0317$ ,  $k$  power of prime, possibly relevant to condensed matter physics.

Scaling hypothesis provides a quantitative model for the density of dark matter at various p-adic length scales and follows naturally from p-adic fractality hypothesis. Scaling hypothesis states that the net  $Z^0$  charge to nuclear  $Z^0$  charge ratio denoted by  $1/\sqrt{\epsilon_Z(p)}$  scales as  $1/L_p^3$ , where  $L_p$  is the p-adic length scale associated with the massive object and related to the size of the massive object by some numerical coefficient not too far from one.

#### Modification of the effective gravitational constant

The scaling law for  $Z^0$  charge implies definite prediction for the effective gravitational force between two sufficiently small objects.  $Z^0$  repulsion leads to the reduction of the effective gravitational force between small test masses. The value of the effective gravitational constant for the interaction between small test particles is

$$G_{eff} = \left(1 - \frac{F_Z}{F_G}\right)G . \tag{2.7.1}$$

where  $F_Z$  and  $F_G$  denote  $Z^0$  and gravitational forces between test masses. Define  $L_w$ , as the p-adic length scale associated with nuclear exotic weak bosons. According to [K71], one has  $L_w = nL_e(113)/v_0 \simeq xnL_e(135)$ ,  $x \in [1, 2]$ . For  $n = 1$  this length scale is in the range 1-2 Angstrom and for  $n = 3$  in the range 3-6 Angstrom (this option seems to hold true in water and living matter).

Using this input one obtains an explicit formula for  $F_Z/F_G$  as



$$\begin{aligned}
\frac{F_Z}{F_G} &= \alpha_Z Q_Z^2(n) \frac{1}{Gm_p^2} \frac{N^2}{A^2} \left(\frac{L_w}{L_p}\right)^6, \\
\alpha_Z Q_Z^2(n) &= \frac{\alpha_{em} Q_Z(n)^2}{\sin(\theta_W) \cos(\theta_W)}, \\
Q_Z(n) &= \frac{1}{4} + \sin^2(\theta)_W \simeq 1/2, \\
\sin^2(\theta_W) &\simeq 0.23.
\end{aligned} \tag{2.7.2}$$

$Gm_p^2 \simeq 10^{-38}$  is the ratio of proton mass squared to Planck mass squared (units  $\hbar = 1$ ,  $c = 1$  are used).  $\alpha_Z$  is  $Z^0$  coupling constant strength,  $\alpha \simeq 1/137$  is fine structure constant and  $\theta_W$  denotes Weinberg angle,  $m_p$  is proton mass and  $A$  denotes mass per atomic volume  $a$  of atom or molecule in question.  $N \times a^3/L^3(k)$  is the nuclear anomalous weak isospin per atomic volume using neutron's weak isospin  $Q_Z(n)$  as a unit and assuming p-adic fractality.  $0 \leq N \ll A$  is expected to hold true since nuclear anomalous charge corresponds to weakly charged color bonds carrying  $N = \pm 2$  units of neutrino weak isospin. The dependence of the force ratio is very sensitive to  $L_p$ : a scaling by a factor of 2 implies a reduction by a factor  $2^{-6}$ .

This gives an estimate for the length scale  $L_{cr}$  at which  $Z^0$ -and gravitational forces have same strength.

$$L_{cr} = \left[ \alpha_Z Q_Z^2(n) \frac{N^2}{A^2} \frac{1}{Gm_p^2} \right]^{1/6} L_w. \tag{2.7.3}$$

Numerical estimate gives

$$L_{cr} \simeq .07 \times \left(\frac{N}{A}\right)^{1/3} \times \frac{L_w}{L_e(139)} \text{ mm}. \tag{2.7.4}$$

Consider Fe ( $A = 56$ ) as an example. For  $N = 1$  (just an ad hoc assumption) and  $n = 1$  giving  $L_w = xL_e(135)$ , the length scale in question would be  $L_{cr} = 4.85x \mu\text{m}$  for so that cell length scale would be the critical length scale. For  $n = 3$  one would have  $L_{cr} = 14.5x \mu\text{m}$ . By p-adic length scale hypothesis the nearest physically favored p-adic length scale above  $L_{cr}$  corresponds to  $L_e(169) = 5 \mu\text{m}$  for  $n = 1$ ,  $x = 1$  and the nearest p-adic length scale below to  $L_e(167) = 2.5 \mu\text{m}$  and corresponds to the largest Gaussian Mersenne in the sequence of Gaussian Mersennes  $(1+i)^k - 1$  labelled by  $k = 151, 157, 163, 167$ . Thus Gaussian Mersennes would correspond to length scales for which the dark weak force wins the gravitational force. The change of the sign of the effective gravitational coupling constant is so dramatic effect that it should certainly reveal the presence of the new force.

The critical length scale is not very sensitive to  $N/A$ . For water with  $A = 18$  and  $n = 3$  one would obtain using the same parameter values the result  $L_{cr} = 21.2 \mu\text{m}$  which is slightly above  $L_e(173) = 20 \mu\text{m}$ .

Interestingly, there is a little bit more than rumor that Eötvös group [E14] has found below 100 microns evidence for a deviation of the strength of gravitational force from the Newtonian prediction at 4 sigma confidence level. The group is still performing additional tests before publishing the result. The effect is weakening of gravitational force and could thus be explained in terms of dark  $Z^0$  force. What is also interesting that M-theory inspired models tend to predict that gravitational force gets stronger at these distances [E26].

## 2.7.2 How to directly test the presence of classical $Z^0$ force?

Standard Cavendish experiment [E3] is based on the measurement of the torsion angle of a torsion pendulum. Small test masses  $m$  are connected by a bar and this structure hinges from the middle point of the bar by a thread. The introduction of the large masses located symmetrically with respect to the origin causes a torque and the value of the gravitational constant can be deduced from the value of the torsion angle. This experiment does not reveal the classical  $Z^0$  force since

small masses are connected by bar fixing their mutual distance and thus effectively eliminating classical  $Z^0$  force.

To reveal the presence of the classical  $Z^0$  force, one should use free gravitational penduli and measure precisely the distance between them in equilibrium position with and without external masses to see whether the classical  $Z^0$  interaction between the small test masses is present. Wuppertal group [E3] has applied this method to determine the value of gravitational constant. Thus it seems that the technology making possible to test TGD predictions might already exist.

One can consider two variants of the Wuppertal experiment [E3] .

1. Large masses are located symmetrically on the opposite sides of the plane of penduli on the line bisecting the line connecting the penduli. Therefore the net gravitational force caused by them is parallel to the axis connecting the small masses and tends to bring the small masses closer to each other.
2. Large masses are located on the line connecting small masses and the gravitational force tends to pull small masses apart from each other.

One can however consider much simpler experiment. In the initial situation there is only single pendulum and the distance from a fixed reference point to pendulum is measured. Then second identical pendulum is introduced on the axis connecting reference point and the first pendulum and the distance to the first pendulum is measured again. From the change of the distance the value of the effective gravitational constant is deduced. The sign of the distance increment tells also whether the force between the penduli is attractive or repulsive. A practical manner to perform the experiment is perhaps following.

1. Constraint the second pendulum to the configuration  $\theta = -\pi$  so that the pendulum points upwards where its interaction with the first pendulum is much weaker than in equilibrium position.
2. Remove the constraint and allow the pendulum to go to the equilibrium position  $\theta \simeq 0$ .

### Direct measurement of the classical $Z^0$ force

Let z-axis be in the direction of Earth's gravitational field. Let the two gravitational penduli have length  $l$  and mass  $m$ . Assume that the suspension points have transversal distance  $d$ . It is convenient to choose the coordinates in such a manner that penduli are at x-axis and that the x-coordinates for the points of suspension are  $x = -d/2$  and  $x = d/2$ . In the first situation there is only one pendulum at  $x = d/2$  and distance to it is measured from some point of x-axis with coordinate  $X > d/2$ . The second pendulum is introduced at  $-d/2$  and the change of the distance of the first pendulum to a fixed reference point is measured.

The penduli are affected only by Earth's gravitational force and possibly also by classical  $Z^0$  force which only renormalizes the effective gravitational coupling constant:  $G \rightarrow XG$ . The potential energy is thus given by

$$\begin{aligned} V &= -X \frac{Gm^2}{r_{12}} + mgl [\cos(\theta_1) + \cos(\theta_2)] \ , \\ r_{12} &= d + l(\sin(\theta_1) + \sin\theta_2)) \ . \end{aligned} \tag{2.7.5}$$

$\theta_i$  denote the deviations of the penduli from the vertical direction defined by the direction of  $g$ . Equilibrium position corresponds to symmetric configuration  $\theta_1 = \theta_2$  and the requirement that potential is minimum determines the values of  $\theta_i$ . Since extremely small deviations from  $\theta_i = 0$  are in question, one can linearize with respect to  $\theta_i$ . The result is

$$\begin{aligned} \theta_1^0 &= \frac{XG_1}{1 + 4G_1w} \ , \\ G_1 &= \frac{g_1}{g} = \frac{m}{M_E} \frac{R_E^2}{d^2} \ , \\ w &= \frac{l}{d} \ . \end{aligned} \tag{2.7.6}$$

If one can directly measure the distance of the first pendulum from a point of x-axis both in absence and presence of the second pendulum, it is possible to deduce the value of  $\theta_1$  from the relation

$$\Delta x = l\theta_1^0 ,$$

and from this to deduce the value of the parameter  $X$ . In excellent approximation  $\theta_1$  is given by

$$\theta_1 \simeq Xg_1/g = X \frac{R_E^2}{d^2} \frac{m}{M_E} .$$

Here  $R_E \simeq 6.6 \times 10^6$  meters is the radius of Earth and  $M_E \simeq 6 \times 10^{24}$  kg is the mass of Earth. For  $d = .1$  meters and  $m = 10^{-2}$  kg this gives  $\theta_1 \sim 6 \times 10^{-9}$  radians. If one can make the length  $l$  of the pendulum large, the value of  $\Delta x$  could perhaps be made so large that it becomes detectable. For  $l = 1$  m the deviation would be  $10^{-8}$  meters for  $X = 1$ . Note that the value of  $\theta_1$  does not depend on the mass of the pendulum.

If classical  $Z^0$  force is present and obeys scaling law, the value of  $\theta_1$  can change its sign and, behaving as  $1/L^6$  as a function of the size  $L$  of the test mass, can increase dramatically for very small test mass sizes. Also this could make the experiment feasible. The mere decrease of the distance would immediately tell that the net force is repulsive. One must however consider the possibility that the p-adic prime characterizing the pendulum is not determined by the size of the mass blob but by the size of the entire pendulum and could thus be much larger. In this case no dramatic effects are to be expected.

### Introduction of the large masses

The initial situation of the experiment corresponds to the presence of two gravitational penduli on x-axis at points  $x = -d/2$  and  $x = d/2$ . This situation was already treated. Larger masses  $M$  are introduced. There are two manners to introduce them.

1. Cm coordinates of the large masses are on the plane determined by penduli. The coordinates for their positions are either

$$\begin{aligned} (x, y, z) &= (x_1, 0, h) , \\ (x, y, z) &= (-x_1, 0, h) . \end{aligned} \tag{2.7.7}$$

2. Cm coordinates of the large masses are on y-axis and symmetrically related to the plane of the penduli

$$\begin{aligned} (x, y, z) &= (0, h, 0) , \\ (x, y, z) &= (0, -h, 0) . \end{aligned} \tag{2.7.8}$$

The distance of the large mass from nearby small mass is  $r = \sqrt{h^2 + (x - d/2)^2}$  and the difference for x-coordinates of  $M$  and  $m$  is  $r_x = x - d/2$ . The parameters  $l, d, r_x$  and  $h$  characterize the geometry of the arrangement. Convenient dimensionless parameters are following

$$\begin{aligned} u \equiv \cos(\psi) &= \frac{r_x}{r} , \quad v \equiv \frac{l}{r} , \quad w = \frac{l}{d} , \\ r_x &= x - d/2 , \quad r = \sqrt{h^2 + (x - d/2)^2} . \end{aligned} \tag{2.7.9}$$

There are two parameters,  $G_1$  and  $G_2$  characterizing gravitational forces experienced by small mass  $m$ .  $G_1$  characterizes the acceleration caused by second small mass  $m$  and  $G_2$  characterizes the acceleration caused by the nearest big mass  $M$ . These parameters are given by

$$\begin{aligned}
 G_1 &= \frac{g_1}{g} = \frac{m}{M_E} \frac{R_E^2}{d^2} , \\
 G_2 &= \frac{g_2}{g} = \frac{M}{M_E} \frac{R_E^2}{r^2} , \\
 r &= \sqrt{h^2 + (x - d/2)^2} .
 \end{aligned} \tag{2.7.10}$$

The deviations of the gravitational force between small test masses caused by the classical  $Z^0$  force could affect the measured value of  $G$  only if the gravitational force between the small is sufficiently large. The parameter which turns out to measure the importance of the gravitational force between small masses is given by

$$\begin{aligned}
 p &\equiv \frac{G_1}{G_2 u} , \\
 u &\equiv \frac{r_x}{r} \equiv \cos(\psi) .
 \end{aligned} \tag{2.7.11}$$

Here  $\psi$  is the direction angle of the position of large mass  $M$ . It is convenient to characterize the effective gravitational force between small test particles by the parameter

$$X = \frac{G_{eff}(m, m)}{G} .$$

This reduction of gravitational force between small test masses causes change of the gravitational constant as given by Wuppertal experiment. The change is not necessarily large. The ratio

$$Y = \frac{G_{meas}}{G}$$

between the measured and actual gravitational constants is a convenient experimental parameter to describe the effect of  $Z^0$  force. The intention is to derive the formulas relating to each other the parameters  $X$  and  $Y$ .

### The two variants of the Wuppertal experiment

Consider now the situation when big masses are brought near the small masses in the two manners corresponding to two versions of the Wuppertal experiment. The potential energy  $V$  of the previous case is replaced with  $V + V_{int}$ , where  $V_{int}$  is ordinary gravitational potential energy to which  $Z^0$  force does not contribute if the size of the test masses is large enough.

1. For the first variant of Wuppertal experiment one has

$$\begin{aligned}
 V_{int} &= -\frac{GmM}{r_{1a}} - \frac{GmM}{r_{2a}} , \\
 r_{1a} &= \sqrt{h^2 + (r_x - l \sin(\theta_1))^2} , \\
 r_{1b} &= \sqrt{h^2 + (r_x - l \sin(\theta_2))^2} , \\
 r_x &= x - d/2 .
 \end{aligned} \tag{2.7.12}$$

The interaction energy of small mass with the second large mass is neglected for simplicity.

2. For the second variant of Wuppertal experiment one has

$$\begin{aligned}
V_{int} &= -\frac{GmM}{r_{1a}} - \frac{GmM}{r_{1b}} - \frac{GmM}{r_{2a}} - \frac{GmM}{r_{2b}} , \\
r_{1a} &= r_{1b} = \sqrt{h^2 + (r_x - l\sin(\theta_1))^2} , \\
r_{2a} &= r_{2b} = \sqrt{h^2 + (r_x - l\sin(\theta_2))^2} , \\
r_x &= -d/2 .
\end{aligned}
\tag{2.7.13}$$

$$\tag{2.7.14}$$

The new equilibrium position corresponds to  $\theta_1 = \theta_2$  with

$$\begin{aligned}
\theta_1^1 &= \frac{XG_1 - kG_2u}{1 + 4XG_1w + kG_2f} , \quad f \equiv (1 - 3u^2)v , \\
u &\equiv \cos(\psi) = \frac{r_x}{r} , \quad v \equiv \frac{l}{r} , \quad w \equiv \frac{l}{d} .
\end{aligned}
\tag{2.7.15}$$

The parameter  $k$  specifies the Wuppertal experiment.  $k = 1$  for arrangement 1) in the approximation that force between small mass and second large mass can be neglected.  $k = 2$  for the arrangement b) since gravitational force between small mass and large masses is doubled.

The change of the equilibrium position of pendulum when large masses are brought in, is characterized by the difference  $\Delta\theta = \theta_1^1 - \theta_1^0$  and given by

$$\begin{aligned}
\Delta\theta &= \theta_1^1 - \theta_1^0 \\
&= \frac{XG_1 - kG_2u}{1 + 4XG_1w + kG_2f} - \frac{XG_1}{1 + 4G_1w} .
\end{aligned}
\tag{2.7.16}$$

Note that version 2) of the Wuppertal experiment is obtained from version 1) by the replacements  $G_2 \rightarrow 2G_2$  and  $r_x = x - d/2 \rightarrow -d/2$ .

### How the measured value of $G$ is affected by $Z^0$ force in Wuppertal experiments?

Consider now how the value of  $G$  is effected by the presence of the classical  $Z^0$  force. If one does not take into account the presence of the  $Z^0$  force, one obtains for  $\Delta\theta$  the expression with  $G$  replaced by  $G_{eff} = YG$ :

$$\begin{aligned}
\Delta\theta &= \theta_1^1 - \theta_1^0 \\
&= \frac{YG_1 - YkG_2u}{1 + 4YG_1w + YkG_2f} - \frac{YG_1}{1 + 4YG_1w} , \\
Y &= \frac{G_{meas}}{G} .
\end{aligned}
\tag{2.7.17}$$

One can solve  $Y$  in terms of  $X$  explicitly by equating the two expressions for  $\Delta\theta$  from the resulting second order polynomial equation.

$$\begin{aligned}
Y^2A_2 + YA_1 + A_0 &= 0 , \\
A_2 &= G_1kG_2 \left[ 4(wu + f) - \Delta\theta \left( 4w \frac{G_1}{kG_2} + f \right) \right] , \\
A_1 &= kG_2 \left[ u + \Delta\theta \left( 4 \frac{G_1w}{kG_2} + 4w + f \right) \right] , \\
A_0 &= \Delta\theta .
\end{aligned}
\tag{2.7.18}$$

Because of the numerical instabilities ( $\Delta\theta$  is difference of two very nearly identical quantities which are sums over quantities with hugely different orders of magnitude it is however better to solve  $Y$  iteratively. One can write  $\Delta\Theta$  in the two forms

$$\begin{aligned}\Delta\theta(Y) &\simeq -kG_2u \left[ \frac{Y}{1+Y(B_1-kG_2f)} + Y^2 \frac{G_1}{(1+YB_1)^2} \frac{f}{u} \right] , \\ \Delta\theta(X) &\simeq -kG_2u \left[ \frac{1}{1+X(B_1-kG_2f)} + \frac{G_1X}{(1+XB_1)^2} \frac{f}{u} \right] .\end{aligned}\quad (2.7.19)$$

$\Delta\theta(Y) = \Delta\theta(X)$  gives equation for  $Y$ :

$$\begin{aligned}Y &= A(B+C+D) , \\ A &= 1+Y(B_1-kG_2f) , \quad B = \frac{1}{1+X(B_1-kG_2f)} , \quad C = \frac{G_1X}{(1+XB_1)^2} \frac{f}{u} , \\ D &= -Y^2 \frac{G_1}{(1+YB_1)^2} \frac{f}{u} , \quad B_1 = 4G_1w .\end{aligned}\quad (2.7.20)$$

One can solve this iteratively by substituting  $Y(n)$  to the righthand side to obtain  $Y(n+1)$ .

Numerical experimentation show that  $Y$  is rather stable against variations of  $X$ . Reduction of  $X$  makes  $Y$  larger than one in both cases. It seems that deviations of  $G$  from its standard value caused by classical  $Z^0$  force are rather small.

1. For the variant 1) of the Wuppertal experiment, the calculation using  $m = .005$  kg,  $M = .10$  kg,  $l = .3$  meters,  $d = .001$  meters,  $h = .5$  meters and  $x = .1$  meters gives only 4.2 percent increase of the measured  $G$  for  $X = -10^3$ !
2. For the variant 2) of Wuppertal experiment with same parameter valued ( $x = 0$ ), one obtains 6.5 per cent increase of the gravitational constant.

## 2.8 Appendix: Allais effect as manifestation of classical $Z^0$ force?

Although it seems now clear that Allais effect can be understood as gravitational effect, it makes sense to keep the earlier model explaining Allais effect as a manifestation of classical  $Z^0$  force.

In 1954 Allais performed experiments in which he studied the behavior of paraconic pendulum by releasing the pendulum every 14 minutes and determining the normal of the plane of oscillation [E4, E22, E10, E11] . Earth's rotation causes (apparent) rotation of this plane with velocity of .19 degrees per minute. The experiment happened to overlap 1954 solar eclipse. During the eclipse the pendulum took an unexpected turn, changing the angle  $\theta$  defining the plane of oscillation by  $\theta$  about 13.5 degrees. Allais repeated the experiments in 1959 and found similar result. The anisotropy of  $g$  implied by the result is about  $\Delta g/g \simeq 3 \times 10^{-6}$ , which looks very small as compared to the large value of  $\theta$ . The explanation of apparent discrepancy is that Foucault pendulum amplifies very effectively small anisotropies for  $g$  for small values of oscillation amplitude and is therefore ideal for detecting these anomalies. During the last total eclipse August 11 1999 NASA repeated the experiment but the processing of the data is still going on. Allais observed also anomalies with periods of 24 and 25 hours in the behavior of oscillating paraconic pendulum.

### 2.8.1 Screening of dark $Z^0$ MEs emitted by Sun as an explanation of Allais effect?

In TGD framework one can imagine a possible explanation for the effect claimed by Allais in terms of classical  $Z^0$  force and partial channelling of  $Z^0$  electric gauge flux from "standard" space-time sheet to some other space-time sheets.

1. According to the TGD based models of atomic nuclei and condensed matter [K71, K23] a Foucault pendulum could have have dark  $Z^0$  charge. The modification of the  $Z^0$  interaction of Foucault pendulum with Sun caused by the location of Moon between Sun and Earth could

perhaps explain Allais effect. Dark neutrino cloud surrounding Sun is one possible source of  $Z^0$  force. It seems that  $Z^0$  Coulomb force, although present, is quite too weak. It is however possible that the interaction is mediated by  $Z^0$  MEs, which carry Bose Einstein condensates of essentially massless dark  $Z^0$  bosons behaving like laser beams so that the  $Z^0$  field does not suffer  $1/r^2$  decay. What would happen that the direction of the effective gravitational force on the surface of Earth changes due to  $Z^0$  force of Sun so that also the direction of the plane of oscillation is changed. Since the effect becomes visible only during eclipse, screening of the  $Z^0$  beam by absorption or is most probably involved but one cannot exclude the possibility that Moon acts amplifies the beam via induced emission.

2. If the  $Z^0$  electric field of ME induces the effect the direction of force is orthogonal to the line connecting Earth to Sun. If the rotational motion of Sun causes the emission of  $Z^0$  MEs and the resulting  $Z^0$  field depends on the direction of  $Z^0$  current of Sun in the same manner as in ordinary electrodynamics, the  $Z^0$  electric field given by the time derivative of  $Z^0$  vector potential is proportional to the  $Z^0$  current at the surface of the emitting region and thus tangential to the plane of the orbit of Earth around Sun. Hence  $Z^0$  electric field is in the orbital plane and induces a force which is tangential to Earth's surface and almost orthogonal to the Earth's gravitational field (the tilting of Earth's rotating axis induces small non-orthogonality). No effect is predicted if the rotation plane of the pendulum is in East-West direction and maximal effect results when the pendulum is in North-South direction.
3. The oscillation frequency of the pendulum and oscillation plane should exhibit day-night variation since also Earth modifies  $Z^0$  beam and Earth's gravitational field are opposite at opposite sides of Earth. In fact, Allais has detected periodic variations with period of 24 and 25 hours in the behavior of the Foucault pendulum [E10, E11]. 24 hour period would be naturally due to the modification of  $Z^0$  beam by Earth and the 25 hour period could be due to the rotation of moon which means that the Sun at moon are at same line with a period which is slightly longer than 24 hours. Instead of  $2\pi$  Earth must rotate the angle  $2\pi + \Delta\Phi$ ,  $\Delta\Phi \sim \frac{2\pi}{30} = 12$  degrees and thus the period is  $T + \Delta T$ ,  $\Delta T = \frac{12}{360} \times 24 = 4/5$  hours.

### 2.8.2 Quantitative picture

Consider now a more quantitative formulation of the model.

1. The force experienced by the pendulum is

$$\begin{aligned}\bar{F} &= [m\bar{g} + \bar{f}_Z]_{\perp} \ , \\ \bar{f}_Z &= \bar{f}_Z \ .\end{aligned}\tag{2.8.1}$$

where  $\bar{f}_Z$  refers to the net  $Z^0$  force caused by Sun. The subscript ' $\perp$ ' refers to the projection to the plane orthogonal to the direction of the pendulum.

2. If the screening caused by Moon by the absorption of  $Z^0$  MEs, Moon effectively creates a shadow, whose size at the surface of Earth is essentially the shadow of Moon to Earth created by light from Sun. This means that effect is seen only during solar eclipse. The modification caused by Moon does not affect the direction of  $\bar{f}_Z$ , which is fixed completely by the geometry of the  $Z^0$  beam and the proposed mechanism generating it. The modification can be parameterized using coefficient  $\epsilon$  characterizing the reduction/increase of the magnitude of  $\bar{f}_Z$ :

$$\bar{f}_Z \rightarrow (1 - \epsilon)\bar{f}_Z \ .$$

For absorption  $\epsilon$  is positive and negative for amplification.

3. Let  $\bar{t}$  denote the unit vector in the direction of the vector connecting the point of suspension for the pendulum and the point at which pendulum is released. Let  $\bar{n}$  denote the direction of  $\bar{F}$ . The normal for the plane of oscillation is given in the direction of  $\bar{e} = \bar{n} \times \bar{t}$ . When Moon is on the line of sight connecting Sun and Moon, the modification of  $\bar{f}_Z$  is largest. The change of the normal of the oscillation plane can be found from the change of the vector  $\bar{e}$ :

$$\begin{aligned} \bar{e} &\rightarrow \bar{e}_1 = \bar{e} + \Delta\bar{e} , \\ \Delta\bar{e} &= \Delta\bar{n} \times \bar{t} . \end{aligned} \tag{2.8.2}$$

$\Delta\bar{n}$  can be calculated from a detailed model for the screening of the  $Z^0$  field of the neutrino cloud caused by the presence of the Moon. The value of the angle  $\theta$  is given by

$$\sin(\theta) = \frac{|\bar{e}_1 \times \bar{e}|}{|\bar{e}_1||\bar{e}|} . \tag{2.8.3}$$

The upper bound for  $\sin(\theta)$  is

$$|\sin(\theta)| \leq \frac{|\overline{\Delta g} \times \bar{t}|}{|\bar{g}||\bar{t}|} . \tag{2.8.4}$$

From this upper bound it is clear that if the release angle for pendulum is small so that the cross product  $|\bar{g} \times \bar{t}|$  is small, gravitational anisotropy is amplified dramatically and Foucault pendulum is thus ideal method for detecting gravitational or other anomalies.

According to the experiments of Allais [E10, E11] the following estimate holds true:

$$\frac{\epsilon f_Z}{mg} \simeq 3 \times 10^{-6} . \tag{2.8.5}$$

For MEs the  $\bar{f}_Z$  is approximately orthogonal to  $\bar{g}$  so that the strength of gravitational field effectively increases in the absence of screening. Since the change of the effective gravitational force of Earth is  $-\epsilon f_Z(\text{Sun})$ , effective  $g$  is predicted to increase if  $\epsilon$  is positive as it is for screening.

The value of the parameter  $\epsilon$  can be estimated by studying the time dependence of  $\delta g/g$  explaining the anomalous behavior of Foucault period with a period of 24 hours observed by Allais [E10, E11]. The dependence of the size of the effect on the size and physical properties of the pendulum makes it possible to test further the model.





## Chapter 3

# The Notion of Free Energy and Many-Sheeted Space-Time Concept

### 3.1 Introduction

In this chapter a T(opological) G(eometro)D(ynamics) based vision about new energy technologies is discussed. There are close connections to the basic mechanisms of energy metabolism in living matter in TGD Universe and one cannot avoid reference to TGD inspired quantum theory of consciousness.

#### 3.1.1 Basic new elements of TGD ontology

The ontology of TGD Universe involves several new elements. The assumption that space-times are 4-surfaces in 8-dimensional imbedding space  $M^4 \times CP_2$  leads to the notion of many-sheeted space-time meaning that each physical system can be said to correspond to space-time sheet, its own sub-universe in the geometric sense, and glued to a larger space-time sheet and containing subsystems as smaller space-time sheets glued to it. p-Adic length scale hypothesis quantifies this notion.

Many-sheeted space-time leads to the notion of field body [K23, K5, K39] distinguishing between TGD and Maxwell's electrodynamics. One can assign to each physical system a field body (or magnetic body) and in the case of living matter it acts as intentional agent using biological body as a sensory receptor and motor instrument. This profoundly changes the view about what we ourselves are.

Zero energy ontology [K16] states that any physical system has a vanishing net energy so that everything is creatable from vacuum. Zero energy states decompose into positive and negative energy parts and positive energy ontology results in certain limit in a good approximation. The possibility of negative energy signals is one important implication and a considerable modification of thermodynamics is forced by the fact that different signs of energy correspond to different arrows of geometric time.

Negative energy signals propagating to the geometric past inspire a new vision about communications and energy technology. The implications are especially important for the understanding of living matter where both time directions manifest themselves. In neuroscience a radically new view about memory based on the notion of 4-D brain emerges.

The hierarchy of Planck constants [K26] implies a generalization of the notions of imbedding space and space-time and macroscopic quantum coherence in all length and time scales at high enough levels of dark matter hierarchy assigned to the hierarchy of Planck constants. The consequences of this hypothesis are powerful: entire cosmos should be in a well-defined sense a living system with dark matter representing higher level conscious entities.

The original motivation for the p-adic physics [K73] were the highly successful calculations of elementary particle masses based on p-adic thermodynamics and conformal invariance [K41]. The

model explained not only the ratio of proton and Planck masses but also masses of particles with an excellent accuracy. The only sensible interpretation of p-adic physics seems to be as physics of cognition and intentionality meaning that cognition is present even at elementary particle level.

The necessity to fuse p-adic physics corresponding to different primes  $p$  forces a generalization of the notion of number by gluing different number fields together along common rationals and algebraics. This leads to a further generalization of the notions of imbedding space and space-time. The basic idea is that p-adic space-time sheets are representations for intentions and cognitions and their transformation to real ones in quantum jumps corresponds to the transformation of intention to action. Zero energy ontology is absolutely essential for this interpretation to make sense. p-Adic space-time sheets have literally infinite size in the real sense which means that cognition and intentionality are cosmic phenomena whereas cognitive representations defined by discrete intersections of real and p-adic space-time sheets obeying same algebraic equations have finite size.

### 3.1.2 Could living systems teach us something about energy technology?

One of the basic problems in energy technology is the necessity to carry fuel. This defines the most serious restriction to space travel.

Biological systems have resolved this problem by using sunlight as an energy source. The basic idea is very simple: solar radiation induces a dissociation of molecules to atoms which then re-associate and liberate metabolic energy. The hydrocarbons serving as fuel are recycled and there is a division of labor: animals cells burn the hydrocarbons to carbon dioxide and plants regenerate the hydrocarbons in photosynthesis.

Most of our energy technologies lack this kind of recycling. For instance, fuel in cars is burned to carbon dioxide and various wastes. If recycling were possible and if the density of potential energy sources in space were high enough, the amount of fuel would not depend on the distance traveled. This observation suggests self-organizing and perhaps in some primitive sense living technology and thus a connection with a fundamental problem of understanding how life has evolved. TGD provides a quantum model of both ordinary and pre-biotic life [K5, K27] and one can hope that this might help to develop a vision about "living" energy technology.

The recycling need not resolve completely the problems related to the fuel. The optimal solution would be "No fuel at all" with fuel serving only as an energy reserve. The system should be able to suck the energy from a system able to provide it. This is possible in TGD Universe [K5, K34]. Zero energy ontology implies that systems can get energy by sending negative energy signals to a system serving as an energy storage. Population inverted laser like system is the simplest system that one can imagine. Negative energy signals have interpretation as phase conjugate laser light. By the analog of stimulated emission negative energy quanta can also induce a cascade in population inverted laser like system so that system could send positive energy signal to the receiver. "Quantum credit card" is indeed the basic metabolic mechanism in TGD inspired quantum biology making possible instantaneous metabolic energy gain. The mechanism is also extremely flexible, which is a definite evolutionary advantage "in jungle".

The quantization of metabolic currencies is essential in living matter and this engineering principle is realized in TGD Universe at the fundamental level [K5]. The energies liberated in the dropping of particles to larger space-time sheets correspond to the increments of zero point kinetic energy (forgetting the interaction energy with matter) and by p-adic length scale hypothesis they are quantized. The basic metabolic energy currency of living matter, which is about .5 eV, corresponds to the dropping of proton from space-time sheet having atomic size scale.

One can also worry about how to transfer the positive quanta of radiation energy over large distances since also other systems than receiver could do it. Also negative energy signals intended to be amplified to much larger positive energy signals in population reverted laser might be absorbed during their travel. Here the quantization of Planck constant might come in rescue. For instance, if photons with energies equal to those of visible or UV photons or even of gamma rays, are transformed to dark photons with much longer wavelength, one can hope that only systems able to transform this radiation into ordinary photons can absorb it. It might well be that water, which is the basic element of living matter, is exceptional in the sense that it can induce the transformation to dark photons and back. The transformation of large Planck constant photons to ordinary ones makes also possible control of shorter length and time scales by much longer ones.

### 3.1.3 Various anomalies as support for the picture

There are surprisingly many well established anomalies supporting the new ontology and these anomalies have been a strong guiding line in attempts to construct a general theoretical framework.

1. There is a considerable support for many-sheeted space-time quantified by p-adic length scale hypothesis. Quite recently I learned about an anomalous radiation from interstellar dust having no generally accepted interpretation in terms of molecular transitions. The interpretation in terms of metabolic energy quanta liberated in dropping of electrons or protons to larger space-time sheets makes sense. A characteristic fractal spectrum involving period doubling is predicted.
2. The Bohr quantization of radii of planetary orbits [K67, K49] , [E29] and quantal effects of ELF em fields on vertebrate brain [K22] helped considerably to develop the ideas about the hierarchy of Planck constants. Later a lot of further anomalies have emerged supporting the quantization of Planck constant. For instance, in gravitational sector Allais effect [K80] , [E2] and accelerating cosmic expansion [K68] support the view about quantum coherence and quantum transitions in astrophysical and even cosmic scales [K67, K49] . Inflationary cosmology is replaced by quantum critical cosmology in TGD framework [K68] .
3. Living matter is one gigantic bundle of anomalies of recent day physics and the notion of field body combined with p-adic length scale hypothesis allows to develop detailed models for how magnetic body controls biological body and receives sensory input from it [K5] . In particular, a successful model for EEG results [K22] and involves hierarchy of Planck constants in an essential manner. One can say that field body applies remote mental interactions to biological body and the so called paranormal phenomena [K58, K75] differ in no essential manner from those encountered in bio-control. The notion of field body leads also to a concrete model for pre-biotic life [K27] based on the notion of plasmoid involving magnetic body controlling plasma phase [K5, K39] .
4. The so called "free energy" phenomena have as bad reputation as cold fusion and homeopathy among most physics professionals: ironically all these disputed anomalies seem to find a natural place in TGD based world order [L3, K78, K32] , [L3] , which suggest that theoreticians should take experimentalists much more seriously. Typically "free energy people" make claims about over-unity production of energy but more or less as a rule the results fail not been reproducible.

Over-unity effects are the basic claim of free energy community. TGD indeed allows temporary over-unity effects [K78]: one possible mechanism is dropping of particles on larger space-time sheets liberating zero point kinetic energy. One can however argue that the topological condensation occurs at all space-time sheets having projection in same region of  $M^4$ . A modification of this mechanism relies on a phase transition increasing the p-adic scale of the space-time sheet. Also phase transitions changing  $h_{eff}$  inducing liberation of cyclotron energy of dark charged particles are possible. TGD inspired theory of living systems.

These mechanisms does not allow a perpetuum mobile: the particles must be kicked back to smaller space-time sheets and in ordinary living matter solar radiation takes care of this. Rotating magnetic systems [H49] define one especially interesting and complex case discussed thoroughly in [K4] .

### 3.1.4 Free energy anomalies

The models for "free energy" phenomena developed much before the recent overall view summarized above had emerged. I know quite well that the reality of these phenomena is debatable and the poor quality of data makes models speculative. I however feel that these models might serve as good theoretical exercises.

#### 1. Podkletnov- and Modanese-Podkletnov effects

The explanation of Modanese-Podkletnov effect [H43] shares many common elements with the model of Podkletnov effect and actually led to the correct track allowing to eliminate competing models.

The "dropping" of electrons to the space-time sheets of topological light rays emitted by a critical system would be the key mechanism besides rotation induced charging. During discharge of the capacitor during discharge (Modanese-Podkletnov effect) this mechanism would induce the motion of test penduli. In the case of a super-conductor making repeatedly a transition to a non-super-conducting state (Podkletnov effect) this mechanism would induce the motion of air above super conductor and apparent loss of weight of test particles. Biefeld-Brown effect associated with lifters and corona wind can be explained by the same mechanism as Modanese-Podkletnov effect. Podkletnov effect is enhanced by the em and  $Z^0$  charging induced by rotation and thus involve also the em and  $Z^0$  variants of Searl effect [K4] .

### 5. Over unity effects

Over-unity effects are the basic claim of free energy research community. TGD indeed allows temporary over-unity effects: the basic mechanism is dropping of particles on larger space-time sheets liberating zero point kinetic energy appearing as basic metabolic mechanism in TGD inspired theory of living systems. This mechanism does not allow a perpetuum mobile: the particles must be kicked back to smaller space-time sheets and in ordinary living matter solar radiation takes care of this. There are also anomalies associated with the dissociation of water and hydrogen molecules. The hydrino atom concept of Mills is also closely related to these anomalies and TGD based justification for the notion is discussed in this chapter.

Since consciousness (memory and intentional action in particular), biology, and new views about energy, communication, and control are tightly related in TGD framework, I will discuss all these topics as a single coherent whole in the following in the hope of demonstrating the unifying power of this conceptualization.

The appendix of the book gives a summary about basic concepts of TGD with illustrations. There are concept maps about topics related to the contents of the chapter prepared using CMAP realized as html files. Links to all CMAP files can be found at <http://www.tgdtheory.fi/cmaphtml.html> [L8]. Pdf representation of same files serving as a kind of glossary can be found at <http://www.tgdtheory.fi/tgdglossary.pdf> [L9]. The topics relevant to this chapter are given by the following list.

- Magnetic body [L19]
- Hierarchy of Planck constants [L17]
- Pollack's observations [L21]

## 3.2 Basic ontology of TGD

TGD leads to an ontology which is new in many respects. The notion of space-time generalizes in several manners. One ends up to the so called zero energy ontology, which means that negative energies are possible and all possible universes are creatable from vacuum. Planck constant, which in the standard quantum theory is a genuine constant, has a discrete spectrum of values and the values can be arbitrarily large [K26, K5] . This means that Universe is a macroscopic quantum system in all scales.

Dark matter could be identified as ordinary matter for which Planck constant differs from its ordinary value so that the interactions with ordinary matter differ in their character from ordinary interactions. Note that TGD predicts also new forms of matter completely dark with respect to electro-weak interactions *gastro, padmass3* .

Dark matter with a large Planck constant is in a key role in the TGD based model of living matter [K53] . Because the new ontology is so central from the point of view of TGD inspired theory of consciousness and living matter, I will represent the basic ideas of TGD using applications to quantum biology to concretize their implications.

### 3.2.1 T(opological) G(eometro)D(ynamics) very briefly

TGD is a unified theory of fundamental interactions which has developed during 28 years [K83] and at the same time expanded to a theory of consciousness providing a model of quantum biology. The key ideas of TGD are following.

1. TGD can be seen as a generalization of either hadronic string model or super-string model (M-theory). The 1-dimensional (1-D) strings moving in 10- or 11-dimensional space are replaced with 3-D surfaces moving in 8-D space. This means that the 2-D orbits of strings are replaced with 4-D surfaces identified as our 4-D space-time but in a widely generalized sense. A further assumption is that these 3-surfaces are "light-like". This assumption bringing in mind esoteric teachings has a purely geometric meaning, and makes it possible to generalize and extend the conformal symmetries responsible for the miraculous mathematical properties of super-string models. These symmetries are in a central role in the formulation of quantum TGD.
2. Another manner to end up with TGD is via a search for a modification of general relativity solving the so called energy problem of general relativity. In general relativity the notions of energy and momentum are not well-defined since the translational symmetries responsible for their existence are lost as space-time becomes curved. If one assumes that 4-dimensional space-time is a 4-D surface in a higher-D space obtained by replacing the points of the empty space-time of special relativity (Minkowski space) with certain internal space- call it  $S$ - having a very small size, the basic symmetries of Minkowski space become those of higher-D space and energy and momentum continue to be well-defined and one obtains a description of gravitation in terms of space-time curvature.
3. The surprise was that this leads to a unified theory for all known interactions - electromagnetic, weak, strong, and gravitational - if one chooses the space  $S$  suitably. The proper choice is  $S = CP_2 = SU(3)/U(2)$ , the complex projective space of 2 complex dimensions.

### 3.2.2 Many-sheeted space-time and the notion of field body

Many-sheeted space-time (see fig. <http://www.tgdtheory.fi/appfigures/manysheeted.jpg> or fig. 9 in the appendix of this book) is one of the basic implications of TGD.

1. Both 3-space and 4-D space-time consists of sheets forming a hierarchical structure ordered with respect to the size of the sheet. Each sheet can be identified as a subsystem, which can correspond to any object of our nearby environment, astrophysical object, cell level system, atom, etc... My own body defines my own private space-time sheet. Quite generally, the topology of space-time codes for various physical structures.
2. Every system is accompanied by various kinds of fields such as electromagnetic and gravitational fields. These fields cannot be assigned to any particular subsystem in standard physics. In TGD the situation is different: one can assign to each system a "field body" consisting of field quanta. For instance, magnetic body consists of quanta of magnetic flux (tubes, sheets,..) realized as space-time sheets much larger than the system. One can also speak about field bodies which mediate interactions and connect field bodies").
3. In TGD inspired intentional agent" which receives sensory information from the biological body and utilizes it as a motor instrument. The finding of Libet passive that our sensory data has age which is a fraction of second could be understood in terms of time lapse resulting from the communication of sensory data to the magnetic body using EEG. From Uncertainty Principle one can conclude that in the EEG the size scale of magnetic body is of order of size of Earth. As a matter fact, magnetic body is predicted to have onion-like fractal structure and communications to various layers of the onion would take place using fractal variants of EEG. The existence of fractally scaled variants of some parts of EEG (alpha band and its harmonics in particular) is a testable prediction of the model.
4. What is also new and highly non-trivial is that field body and biological body are essentially four-dimensional structures. The brain and body of geometric past still exist as mental images which we experience as memories. Biological death means only the arrival of a particular wave of consciousness to the time-like boundary of a 4-D body. Consciousness at the level of 4-D body does not cease: our past lives.

5. Many-sheeted space-time leads also to a generalization of the notion of subsystem which in TGD inspired theory of consciousness corresponds to a subself experienced by self (system) as a mental image. What is new is the paradoxical sounding prediction that even in the case that two systems are unentangled, subsystems can entangle. Entanglement of sub-selves can be interpreted as giving rise to sharing and fusion of mental stereo consciousness (stereovision would be one example of this). Consciousness would not be completely private and there would exist a pool of shared and fused mental images making for instance possible to assign universal meaning to the symbols of language. This new view about entanglement was originally motivated by the observation that two space-time sheets condensed at larger space-time sheets can be connected by bonds while the larger space-time sheets can remain unconnected (see Figure 3). By quantum classical correspondence the bonding of the space-time sheets serves as a space-time correlate for entanglement. Much later (only a couple years ago) the generalization of quantum measurement finite measurement resolution allowed to mathematicize this concept [K86, K26]. Entanglement is always defined with respect to a resolution characterizing the system and the entanglement of subsystems is not visible in the resolution characterizing the system. The notions of quantum groups and non-commutative geometry emerge naturally in the description of finite measurement

### 3.2.3 The hierarchy of Planck constants and of dark matter

The hierarchy of Planck constants is a relatively new element of TGD. The idea emerged as I constructed a model of topological quantum computation [K84] and after learning about the work of Nottale [E29] I realized that the notion is more or less forced by quantum classical correspondence implying that space-time sheets define regions of macroscopic quantum coherence and by the fact that they can have arbitrarily large size.

#### Physical motivations for introducing the hierarchy of Planck constants

There are several reasons to consider the possibility that Planck constant  $\hbar$  is actually not a constant but can have a set of quantized values which can be arbitrarily large.

1. One observation is the quantization of the radii of planetary orbits (also those of exo-planets) in the same manner as in the case of hydrogen atom [E29]: now however the value of Planck constant is gigantic:  $\hbar/h_0 = GMm/v_0$ , where  $M$  and  $m$  are the masses of Sun and planet,  $G$  is Newton's constant and  $v_0$  is a dimensionless constant (in units  $c = 1$ ), whose favored value is  $v_0 = 2^{-11}$ . Also other values are possible. In TGD based model [K67, K49] the gravitational Planck constant is assigned with the "relative field bodies" connecting Sun and planet and mediating gravitational interaction between them. The interpretation is that gravitational Planck constant is associated with dark matter, which is macroscopic quantum phase in astrophysical scales. Visible matter condensed around dark matter would reflect the quantal properties of dark matter.
2. Second motivation comes from the observed effects of ELF radiation on vertebrate brain [J11], which can be both physiological and affect behavior. These effects appear at harmonics of cyclotron frequencies of biologically important ions (in particular  $\text{Ca}^{++}$  ion) in a magnetic field of  $B = .2$  Gauss (the nominal value of Earth's magnetic field is .5 Gauss) and are very quantal. These frequencies are in EEG range (harmonics of 15 Hz for Calcium ion). Standard quantum mechanics does not allow quantal effects since the energy of EEG photons is extremely low and much below the thermal energy at body temperature. If the value of  $\hbar$  is large enough, the effects of ELF photons are not masked by thermal noise, and the effect can be understood [K22].
3. If EEG consists of photons with large Planck constant, one can understand the correlation of EEG with the state of brain and contents of consciousness [K22]. In particular, temperature ceases to be a restriction for life: for sufficiently large Planck constant even the interiors of planets and Sun could serve as seats of life of some kind. This kills a central counter argument against the claim of a Romanian group of physicists that since the plasmoids

created in electric circuits possess some features assigned usually to life, they indeed represent primitive life forms [I43] .

4. The mathematization for the notion of Planck constant hierarchy [K26] involves a further generalization of the space-time concept discussed in the Appendix. The basic prediction is that Planck constant corresponds to a discrete subgroup of rotation group acting as the symmetries of the field body of the dark matter system. A hierarchy of favored values of Planck constant and symmetry groups emerges from simple number theoretic arguments. For instance,  $h = nh_0$ ,  $n = 5, 6$ , correspond to the favored values of Planck constant. In this case the symmetry group would correspond to the symmetries of 5- and 6-cycles appearing in polycyclic aromatic hydrocarbons [I3, I36] known to be important for life. Examples are the cycles appearing in DNA, in some amino-acids, in most hallucinogens except alcohol, and PAHs in the interstellar space [I3, I36] believed to result via photosynthesis and believed to be amino-acids and other bio-molecules.
5. The basic prediction is that large values of Planck constant correspond to discrete symmetries: typically discrete group of symmetries acting as rotations around a fixed symmetry axes. These symmetries acted as symmetries of dark field body. In the original view about generalized imbedding space (Appendix) these symmetries would be almost continuous symmetries for larger values of Planck constant. The breaking of these symmetries at the level of visible matter condensed around dark matter could lead to much smaller subgroups of these symmetry groups and structures analogous to those appearing in molecular physics could be the outcome. The further generalization of imbedding space (Appendix) allows also discrete symmetry groups  $Z_n$  for dark matter with small value of  $n$  and also genuinely three-dimensional symmetry groups (tetrahedral, octahedral, icosahedral, and octahedral). There is evidence for this kind of symmetries. For instance, there is a strange hexagonal structure appearing at the North pole of [E7] [E6] . Planetary rings is second example and some of them even contain helical structures analogous to DNA double strand rings .
6. Large Planck constant photons at radio frequencies could interact strongly with living matter and it would become possible to communicate with living matter over very long distances. This mechanism would involve a de-coherence of large Planck constant photons to ordinary ones with same energy or a bundle of ordinary photons with much smaller energy. This brings in mind the recent discovery that the irradiation of salt water by radio waves at harmonics of frequency 13.4 Ghz makes it "burn" that is emit burning gases. A possible explanation is that radio wave photons are transformed in water to photons of same frequency but much larger Planck constant and in de-coherence to ordinary photons with same energy microwave photons which excite rotational excitations of NaCl (in equilibrium with  $\text{Na}^+$  and  $\text{Cl}^-$  ions) and in this manner heat it just like microwave oven does [K23] . The required value of Planck constant would be by a factor  $2^{10} = 1024$  larger than normal Planck constant. This value is one of the number theoretically simple values defined as ratios of integers defining polygons constructible using only ruler and compass [K26] . For water molecules the needed value of Planck constant is obtained from the microwave oven frequency 2.45 GHz and would be with .1 per cent accuracy equal to  $h/h_0 = n = 187 = 11 \times 17$ :  $n$  does not belong to the set of number theoretically simple values of  $n$  but one cannot of course exclude it.

### The notion of field body and dark matter

The conclusion would be that each physical system is accompanied by a field body with a fractal, onion-like, structure formed by field bodies. This leads to the following vision about the nature of living matter.

1. Each layer of the onion is characterized by the value of Planck constant telling its position in the hierarchy of dark matter.
2. At the surface of the onion the value of Planck constant is largest and in some sense defines the "IQ" of the system. At the level of molecules one expects rather low values of Planck constants. For instance, the magnetic body assignable to the ordinary EEG as has of order Earth size and the lifetime of human (say 70 years) would correspond to a layer with size of



order light-life (70 light years). Even higher layers might be present: transpersonal states of consciousness would indeed naturally correspond to these layers.

Field body receives information from the biological body and quantum controls it.

1. In the case of ordinary living matter field body would naturally receive information from cell membranes, which are full of receptors monitoring the state of environment. This cell membranes are Josephson junctions and that Josephson currents code this information and communicate it to some layer in the onion formed by magnetic bodies. Dark matter hierarchy suggests even the existence of fractally scaled up counterparts of cell membrane and the TGD based model of EEG relies on this assumption. What is encouraging that the model predicts correctly the decomposition of EEG into bands, in particular alpha band, explains why high arousal correspond to chaotic looking activity in beta band, and predicts also correctly the positions of narrow sub-bands in beta and theta bands [J24]. The strange findings challenging pump-channel paradigm [I47] (ionic currents seem to be quantal and same even for artificial membranes; currents continue to flow in absence of metabolism) support superconductivity hypothesis and Ohmic currents are only for the purposes of measuring the concentrations of various ions in cellular environment and that metabolic energy goes to the communications to the magnetic body using generalized EEG.
2. Magnetic body controls biological body through the genome. This inspires the hypothesis that magnetic flux sheets go through DNA strands and genes form what could be regarded as text lines at the page of book defined by the flux sheet. The quantization of magnetic flux with unit proportional to Planck constant implies that for large values of  $\hbar$  the flux sheets are very wide and can go through a large genomes. One ends up with the notion of super genome meaning that coherent collective gene expression becomes possible in the scale of organ and organism. Hyper genome would in turn fuse the super-genomes to a larger structure making possible coherent collective gene expression at the level of species and population [K31, K22]. This would bring to the theory of evolution completely new "synergetic aspect" and evolution would be much more than fight for survival.
3. The interaction between field body and biological body is essentially remote mental interaction so that paranormal phenomena would differ from normal biological basic interactions only in that field body uses external biological body to remote viewing or psychokinesis.

There are good reasons to assume that field bodies have developed magnetic immune systems to prevent the use of their private biological bodies by alien field bodies. Hypnosis would be example of this kind of possession by a foreign field body. This immune system can be compared to fire wall in computer world (assuming that we have created computers as our own images).

1. The height of the fire wall depends on individual. For very sensitive persons it is very low and these people are very sensitive to suggestions, hypnosis, spiritual experiences, and even encounters of ETs. Very high fire wall makes it impossible to receive even useful information and the fire wall of skeptic might be too high.
2. In the case of computers viruses and cookies are very simple programs making possible for an external computer to partially "possess" the computer via web. Their role is to serve as kind of mediums or couriers. In the case of field body viruses and cookies would correspond to very simple life forms to which immune system does not bite: plasmoids are natural candidates in this respect. This would suggest that anomalous light phenomena ("UFOs") are actually plasmoids (unidentified moving processes rather than objects).

Plasmoids could quantum entangle the brains of the sensitive person to some conscious entity at some higher level of hierarchy and the person would fall in a trance like state able to share mental images of this entity. Patterns of magnetic pulses can be used to generate alternative states of consciousness [J25] and the patterned motion of the magnetic body of plasmoids (kind of dance like motor expression!) consisting of flux tubes and sheets with respect to the observer could generate this kind of pulse patterns.

It has been observed that some moving light balls indeed involve magnetic pulses with maximal field strength of about .3 Gauss and typical strength which is 10 times weaker [H13]. The prediction is that the durations of pulses should be inversely proportional to the velocity of motion of the light balls. Also the motion of a magnetometer with respect to living system might course similar pulses.

### 3.2.4 Zero energy ontology

In standard physics the sign of energy is positive. This leads to philosophical problems. The problematic question is what are the values of the conserved quantities of the universe (energy, em charge, quark and lepton number). An additional difficulty is caused by the fact that they are very naturally infinite in positive energy ontology. These questions cannot be answered with the framework of standard physics. On the other hand, TGD inspired cosmology led to a different interpretational problem: the density of non-conserved gravitational mass was non-vanishing as in inertial energy vanishes [K68]. The construction of quantum TGD [K7, K6, K16] finally led to so called zero energy ontology which resolves this problem and also the problems due to the positive energy ontology.

1. All quantum states possess vanishing net values of conserved quantum numbers such as an energy. Or stating it otherwise: every physical state is creatable by intentional action from vacuum.
2. Zero energy states decompose into positive and negative energy states such that negative energy state is in the geometric future. If the temporal distance between positive and negative energy states is long as compared to the time scale of perception, the usual positive energy ontology works well. In the opposite case the zero energy state can be interpreted as a quantum fluctuation having no importance for the world as we perceive it.

#### Zero energy ontology and unification of the notions of S-matrix and density matrix

Zero energy ontology states that physical states have vanishing net conserved quantum numbers and states decompose into positive and negative energy state and that the latter one can be said to be located in the geometric future of the positive energy state at the time-like boundary of the space-time sheet representing the system. It is possible to speak about energy of the system if one identifies it as the average positive energy for the positive energy part of the system.

The matrix ("M-matrix") representing time-like entanglement coefficients between positive and negative energy states unifies the notions of S-matrix and density matrix since it can be regarded as a density matrix expressible as a product of real squared of density matrix and unitary S-matrix. Essentially matrix valued Schrödinger amplitude is in question with S-matrix representing its "phase". An open question is how universal S-matrix is. The system can be also in thermal equilibrium so that thermodynamics becomes a genuine part of quantum theory and thermodynamical ensembles cease to be practical fictions of the theorist. In this case M-matrix represents a zero energy states for which positive energy state has thermal density matrix.

1. If the positive energy parts of zero energy states appearing in the superposition have only single value of energy, the notion of remote metabolism is certainly well-defined. Even in the case that the system is thermalized remote metabolism makes sense since average energy can be increased by remote metabolism. One can even imagine a statistical variant of the process in which the temperature increases.
2. The critical question is whether crossing symmetry prevails in the sense that the positive energy signal propagating to the geometric future is equivalent to a negative energy signal propagating to geometric past.

#### Time mirror mechanism

Zero energy ontology gives justification for the time mirror mechanism (see fig. <http://www.tgdtheory.fi/appfigures/timemirror.jpg> or fig. 24 in the appendix of this book), which is the fundamental mechanism of TGD inspired model of quantum biology. To avoid confusion one

must distinguish between two times: geometric and subjective time. The latter corresponds to a sequence of quantum jumps giving rise to the conscious sensation of flow of time [K76, K77, K82]. Geometric time corresponds to the time of physicist identified as the fourth space-time coordinate. These times are only loosely related and their identification is only approximate and makes sense only in some states of consciousness. Indeed, subjective time is irreversible and no geometric time is reversible and both future and past exist.

1. Symbolic (declarative) memories can be understood as communications of some onion layer of magnetic body with the brain of the geometric past [K61]. A signal consisting of negative energy phase photons (identifiable as phase conjugate photons in nonlinear optics) with larger Planck constant represents a question to the brain of the geometric past which responds automatically by sending a positive energy signal to the magnetic body in the geometric future. Episodal memories which correspond to literal re-experiences result by time-like quantum entanglement for subsystems mental images.
2. Time mirror mechanism makes possible to realize intentions by sending negative energy signals to the brain of the geometric past and inducing neural activity leading to a motor response in the brain of geometric future [K43, K5]. This kind of mechanism allows more or less instantaneous reaction and provides an evolutionary advantage in "jungle". The mechanism explains Libet's finding [J21] that neural activity is initiated in brain already before the conscious decision. In the usual ontology the interpretation would be that free will is only apparent. In the recent context "before" refers to the geometric rather than subjective time, so that free will is possible quantum jump identified as a moment of consciousness. Dark matter hierarchy implies infinite hierarchy of moments of consciousness with moments of consciousness giving rise to the analog of dark matter hierarchy at the level of conscious entities.
3. The system can receive positive energy as a recoil energy by sending negative energy to a system of geometric past able to receive it. A system analogous to a population inverted laser having more particles in a state of higher energy, is ideal provider of energy. The resulting quantum credit card makes it possible to react very rapidly in situations encountered in "jungle". I have christened this mechanism remote metabolism and magnetic body could use it to suck metabolic energy from brain or body to its own purposes by sending phase conjugate dark (generalized) EEG photons to the biological body. In the case of declarative memories the excited state of the laser like system would naturally correspond to bit 1 and ground state to bit 0 [K61]. Metabolic energy would be needed to restore the mental image since the process of memory recall would tend to reduce the population of excited states. Note that remote metabolism would be tailor made for say space travel UFOs" exist they might apply this kind of energy technology.
4. Many-sheeted space-time provides a concrete realization of the laser like systems as many-sheeted lasers. The "dropping" of particles from smaller to larger space-time sheets liberates zero point kinetic energy [K5]. If the interaction energy with the matter at the space-time sheet can be neglected, p-adic length scale hypothesis makes precise predictions about the maximal liberated energies. The standard metabolic energy currency of about .5 eV of living matter corresponds to the dropping of proton from a space-time sheet of atomic size. Actually a fractal hierarchy of universal metabolic currencies is predicted and should be present already during the pre-biotic evolution so that the chemical storage of energy is not necessary for a primitive metabolism [K27].

In many-sheeted space-time particles topologically condense at all space-time sheets having projection to given region of space-time so that this option makes sense only near the boundaries of space-time sheet of a given system. Also p-adic phase transition increasing the size of the space-time sheet could take place and the liberated energy would correspond to the reduction of zero point kinetic energy. Particles could be transferred from a portion of magnetic flux tube portion to another one with different value of magnetic field and possibly also of Planck constant  $h_{eff}$  so that cyclotron energy would be liberated.

The transitions corresponding to the dropping of particles should be visible in astrophysics and there are indeed exist three kinds of narrow bands of radiation in both visible and infrared

range without identification in terms of known molecular transitions (see discussion below). The energies of the photons in question are consistent with p-adic length scale hypothesis and allow an interpretation in terms of proposed transitions assuming that there is some binding energy with the matter at the smaller space-time sheet [I1].

### More detailed view about time mirror mechanism in zero energy ontology

The notion of negative energy signals and time mirror mechanism emerged before zero energy ontology. Since the mechanisms of remote metabolism, of memory, and of intentional action rely on time mirror mechanism, one should check that this mechanism is indeed consistent with zero energy ontology. Zero energy ontology could also yield new insights to these mechanisms.

#### 1. Is zero energy ontology consistent with time mirror mechanism?

Energy conservation and geometric arrow of time poses strong conditions on the mechanism. If positive energy part of state sends negative energy signal, then negative energy part of state must send a compensating positive energy signal. Furthermore, positive (negative) energy signals propagate towards geometric future (past).

1. If only single space-time sheet is involved, either negative energy signal  $S_-: X^4 \rightarrow Y^4$  or positive energy signal  $S_+: X^4_+ \rightarrow Y^4_-$  is possible. The energy of both states is reduced in magnitude. For instance, this process tends to reduce destroy long term memories represented as bit sequences with bit represented by population inverted laser system.
2. Second possibility is that  $X^4$  and  $Y^4$  are disjoint and  $X^4$  is in the geometric future of  $Y^4$ .

The first possibility is  $S_+: X^4_+ \rightarrow Y^4_-$  and negative energy signal  $S_-: X^4_- \rightarrow Y^4_+$ : the energy of both  $X^4$  and  $Y^4$  is reduced in this case.

Second possibility is  $S_-: X^4_+ \rightarrow Y^4_+$  and  $S_+: Y^4_- \rightarrow X^4_-$ .  $X^4$  would suck energy from  $Y^4$  in the geometric past. This option could correspond to both remote metabolism, memory recall, and intentional action. The presence of topological light ray connecting two systems would be also a correlate for time-like quantum entanglement making possible sharing and fusion of mental images and creating a sensation about flow of time just like it creates sensation of depth in stereo vision by fusion of right and left visual fields. Depending on the sign of the energy of the signal one would have memory or precognition. Precognition would require use of metabolic energy and this might be one reason for why it is rather rare.

3. Suppose next that the zero energy space-time sheet, call it  $X^4$ , is inside larger space-time sheet, call it  $Y^4$ :  $X^4 \subset Y^4$ . In this case one can have  $S_-: X^4_+ \rightarrow Y^4_+$  accompanied by  $S_+: X^4_- \rightarrow Y^4_-$ .  $X^4 \subset Y^4$  would suck energy from a larger system  $Y^4$ . It is of course possible to replace signals with signals of opposite energy in opposite time direction.

A possible interpretation is as a metabolic charging of smaller space-time sheets by sucking energy from longer scales or by active pumping of energy to shorter scales. The transformation of long wavelength photons with large Planck constant to short wavelength photons with smaller Planck constant is an analogous process and might realize metabolic charging in biology. For instance, Sun-Earth system could correspond to  $Y^4$  and biosphere to  $X^4$ .

To sum up, zero energy ontology completes the picture in the sense that it also provides a process making possible metabolic charging.

#### 2. Thermodynamical considerations

It is not at all obvious whether the proposed picture is consistent with the standard thermodynamics. The transfer of energy from long to shorter length scales making possible to gain metabolic energy and realize the mechanism of long term memory indeed seems a genuinely new element. This process resembles dissipation in the sense that energy is transferred from long to short length scales. In an approach to thermal equilibrium temperature gradients are however reduced whereas remote metabolism favors the active generation of "hot spots".

These considerations relate closely to the notions of entropy and syntropy by Italian mathematician Luigi Fantappie [J18] assigned with the two arrows of time. I learned from the work of

Fantappie in SSE conference held in Rörös from Antonella Vannini [J31] and Ulisse Di [J13] [J13]. The discovery of Fantappie was that in living systems entropic processes seem to be accompanied by syntropic processes which seem to be finalistic. He assigned these processes to the advanced solutions of wave equations.

It would seem that entropy and syntropy do not relate directly to the notion of remote metabolism.

1. Syntropy growth would indeed be entropy growth associated with negative energy mirror image of positive energy dynamics. This dynamics could be seen as sequences of downwards scalings leading from long time scale to short time scale. This sequence would define time sequences proceeding in opposite directions of time for positive and negative energy parts of states. Thus entropy growth would be accompanied by syntropy growth.
2. Syntropy growth could be also seen as a consequence of generalized second law applying with respect to subjective time syntropy would be growth of entropy but manifesting itself at space-time level in reversed direction of geometric time. For instance, the spontaneous assembly of bio-molecules from their parts could be seen as a decay process in the reverse direction of geometric time controlled by phase conjugate control signals.
3. Remote metabolism as generation of "hot spots" does not seem to reduce to these notions and might represent a genuine breaking of standard thermodynamical view about the world.

One must also distinguish the notions of entropy and syntropy from the notion of number theoretic entanglement negentropy  $N$  entanglement with algebraic entanglement probabilities [K44].

1.  $N$  is defined as the maximum of the p-adic entanglement negentropy  $N(p)$  as a function of the p-adic prime  $p$  and thus assigns to an entangled system a unique prime  $p_{max}$ .  $N(p)$  is obtained by replacing in the definition of the Shannon entropy the argument of logarithm with its p-adic norm.  $N$  is in general positive and thus defines a genuine measure of information.
2. The non-negative negentropy defined in this manner characterizes entanglement as a carrier of information rather than the state of either of systems and has nothing to do with the ordinary (non-positive) entropy characterizing the lack of knowledge about the state of either subsystem. Negentropy Maximization Principle [K44] favors the increase of the number theoretic negentropy and thus formation of entanglement quantum systems and generation of quantum coherence. Depending on the character of entanglement negentropic entanglement (see fig. <http://www.tgdtheory.fi/appfigures/cat.jpg> or fig. 21 in the appendix of this book) might be interpreted as a correlate for some conscious experience with positive content: say experience of understanding (time-like entanglement implying causal structure), of love (space-like entanglement), etc...

It is not obvious to me whether the remote metabolism as a manner to build hot spots and diversity could be reduced to NMP or whether it should be regarded as something completely independent.

### 3.3 Many-sheeted space-time, universal metabolic quanta, and plasmoids as primitive life forms

In this section evidence for many-sheeted space-time represented together with development of more concrete ideas about plasmoids as primitive life forms. Recall that might form the basis of new energy technology able to recycle the fuel.

#### 3.3.1 Evidence for many-sheeted space-time

The dropping of particle to a larger space-time sheet liberates energy which is the difference of the energies of the particle at two space-time sheets.

In many-sheeted space-time particles topologically condense at all space-time sheets having projection to given region of space-time so that this option makes sense only near the boundaries of space-time sheet of a given system. Also p-adic phase transition increasing the size of the space-time sheet could take place and the liberated energy would correspond to the reduction of zero point kinetic energy. Particles could be transferred from a portion of magnetic flux tube portion to another one with different value of magnetic field and possibly also of Planck constant  $\hbar_{eff}$  so that cyclotron energy would be liberated. In the following only the "dropping" option is discussed.

If the interaction energy of the particle with the matter at space-time sheet can be neglected the energy is just the difference of zero point kinetic energies. This energy depends on the details of the geometry of the space-time sheet. Assuming p-adic length scale hypothesis the general formula for the zero point kinetic energy can be written as

$$E(k) = x \times E_0(k) \quad , \quad E_0(k) = \frac{3}{2} \frac{\pi^2}{mL^2(k)} \quad .$$

Here  $x$  is a numerical factor taking into account the geometry of the space-time sheet and equals to  $x = 1$  for cubic geometry.

The liberated zero point kinetic energy in the case that the particle drops to a space-time sheet labeled by  $k_f = k + \Delta k$  with same value of  $x$  is

$$\Delta E(k, \Delta k) = x \times E_0(k) \times (1 - 2^{-\Delta k}) \quad .$$

The transitions are seen as discrete lines for some resolution  $\Delta k \leq \Delta k_{max}$ . At the limit  $k \rightarrow \infty$  transitions give rise to a quasi-continuous band. The photon energy for  $k \rightarrow \infty$  transition is same as the energy from  $k - 1 \rightarrow k$  transition, which brings in additional option to the model building.

For a proton dropping from the atomic space-time sheet  $k = 137$  to very large space-time sheet ( $\Delta k \rightarrow \infty$ ) one has  $\Delta E(k) = E(k) \sim x \times .5$  eV. Since the ratio of electron and proton masses is  $m_p/m_e \simeq .94 \times 2^{11}$ , the dropping of electron from space-time sheet  $k_e = k_p + 11$  liberates zero point kinetic energy which is by a factor .9196 smaller. For  $k_p = 137$  one would have  $k_e = 148$ . This energy corresponds to the metabolic energy currency of living systems and the idea is that the differences of zero point kinetic energies define universal metabolic energy currencies present already in the metabolism of pre-biotic systems. In the following fit electron's zero point kinetic energy will be taken to be  $E_0(148) = .5$  eV so that for proton the zero point kinetic energy would be  $E_0(137) = .544$  eV.

The hypothesis predicts the existence of anomalous lines in the spectrum of infrared photons. Also fractally scaled up and scaled down variants of these lines obtained by scaling by powers of 2 are predicted. The wavelength corresponding to .5 eV photon would be  $\lambda = 2.48 \mu\text{m}$ . These lines should be detectable both in laboratory and astrophysical systems and might even serve as a signature for a primitive metabolism. One can also consider dropping of Cooper pairs in which case zero point kinetic energy is scaled down by a factor of 1/2.

Interestingly, the spectrum of diffuse interstellar medium exhibits three poorly understood structures [I4] : Unidentified Infrared Bands (UIBs), Diffuse Interstellar Bands (DIBs) [I2] , and Extended Red Emission (ERE) [I52] allowing an interpretation in terms of dropping of protons or electrons (or their Cooper pairs) to larger space-time sheets. The model also suggests the interpretation of bio-photons in terms of generalizes EREs.

### Unidentified Infrared Bands

Unidentified infrared bands (UIBs) contain strong bands at  $\lambda = 3.3, 6.2, 11.3$  microns [I4] . The best fit for the values of  $k$  and  $\Delta k$  assuming dropping of either electron or proton are given by the following table. The last row of the table gives the ratio of predicted photon energy to the energy characterizing the band and assuming  $x = 1$  and  $E_0(148, e) = .5$  eV. Discrepancies are below 8 per cent. Also the dropping of protonic Cooper pair from  $k = 137$  space-time sheet could reproduce the line  $\Delta E = .2$  eV. The fit is quite satisfactory although there is of course the uncertainty related to the geometric parameter  $x$ .

$\lambda/\mu m$	$E/.5eV$	$k$	$\Delta k$	$\Delta E(k, \Delta k)/E$	$p/e$
330	.7515	137	$\sim \infty$	1.002	e
620	.4000	138	3	1.067	e
1130	.2195	139	3	0.878	e
1130	.2195	139+11=150	3	1.076	p

Table 1. Table gives the best fit for UIBs assuming that they result from dropping of proton or electron to a larger space-time sheet and one has  $E_0(148, e) = .5$  eV. The fourth column the table gives the ratio of predicted photon energy to the energy characterizing the band and assuming  $x = 1$ .  $e/p$  tells whether electron or proton is in question.

According to [I4], UIBs are detected along a large number of interstellar sight-lines covering a wide range of excitation conditions. Recent laboratory IR spectra of neutral and positively charged poly-cyclic aromatic hydrocarbons (PAHs) has been successfully used by Allamandola [I36] to model the observed UIBs. It is believed that PAHs are produced in reactions involving photosynthesis and are regarded as predecessors of biotic life [I3]. This would conform with the presence of metabolic energy quanta.

DNA sugar bone, some amino-acids, and various hallucinogens involve 5- and 6-cycles and the proposal is that these cycles involve free electron pairs, which possess Planck constant  $\hbar = n\hbar_0$ ,  $n = 5, 6$ . These free electron pairs would explain the anomalous conductivity of DNA and would be an essential characteristic of living matter. The emergence of  $n = 5, 6$  levels could be seen as the first step in the pre-biotic evolution.

### Diffuse Interstellar Bands

There are diffuse interstellar bands (DIBs) at wavelengths 578.0 and 579.7 nanometers and also at 628.4, 661.4 and 443.0 nm. The 443.0 nm DIB is particularly broad at about 1.2 nm across - typical intrinsic stellar absorption features are 0.1 nm [I4]. The following table proposes a possible identification of these lines in terms of differences of zero point kinetic energies. Also now the best fit has errors below 7 per cent.

$\lambda/nm$	$E/.5eV$	$k$	$\Delta k$	$\Delta E(k, \Delta k)/E$	$p/e$
628.4	3.947	$135 = 3^3 \times 5$	$\sim \infty$	0.987	e
661.4	3.750	$135 + 11 = 2 \times 73$	3	0.985	p
443.0	5.598	$134 = 2 \times 67$	2	0.933	e
578.0	4.291	$135 + 11 = 2 \times 73$	$\sim \infty$	0.986	p
579.7	4.278	$135 + 11 = 2 \times 73$	$\sim \infty$	0.984	p

Table 2. Table gives the best fit for DIBs assuming that they result from dropping of proton or electron to a larger space-time sheet. Notations are same as in the previous table.

The peak wavelengths in chlorophyll and photosynthesis are around 650 nm and 450 nm and would correspond to second and third row of the table.

### The Extended Red Emission

The Extended Red Emission (ERE) [I4, I52] is a broad unstructured emission band with width about 80 nm and located between 540 and 900 nm. The large variety of peak wavelength of the band is its characteristic feature. In majority of cases the peak is observed in the range 650-750 nm but also the range 610-750 nm appears. ERE has been observed in a wide variety of dusty astronomical environments. The necessary conditions for its appearance is illumination by UV photons with energies  $E \geq 7.25$  eV from source with  $T \geq 10^4$  K. The position of the peak depends on the distance from the source [I52].

According to [I4] the current interpretation attributes ERE to a luminescence originating from some dust component of the ISM, powered by UV/visible photons. Various carbonaceous compounds seem to provide a good fit to the observational constraints. However, the real nature of ERE is still unknown since most candidates seem to be unable to simultaneously match the spectral distribution of ERE and the required photon conversion efficiency.

1. Consider first the band 650-750 nm appearing in the majority of cases. The most natural interpretation is that the lower end of the band corresponds to the zero point kinetic energy of electron at  $k = 135 + 11 = 146 = 2 \times 73$  space-time sheet. This would mean that the lines would accumulate near 650 nm and obey the period doubling formula

$$\frac{\lambda(k) - \lambda(\infty)}{\lambda(\infty)} = \frac{2^{-k}}{1 - 2^{-k}} .$$

By the estimate of Table 2 the lower end should correspond to  $\lambda = 628.4$  nm with a correction factor  $x < 1$  reducing the zero point kinetic energy. The reduction would be smaller than 4 per cent.  $\Delta k = 3$  transition would correspond to 744 nm quite near to the upper end of the band. For  $\Delta k = 2$  transition one has  $\lambda = 867$  nm not to far from the upper end 900 nm.  $\Delta k = 1$  corresponds to 1.3  $\mu\text{m}$ .

2. For proton with  $k = 135 = 146$  the energy band would shift by the factor  $2^{11}m_e/m_p \simeq 1.0874$  giving the range (598,690) nm.
3. The variation for the position of the peak can be understood if the charged particles at the smaller space-time sheet can have excess energy liberated in the dropping to the larger space-time sheet. This excess energy would determine the position of the lower end of the band in the range (540, 650) nm.
4. One should also understand the role of UV photons with energy larger than 7.25 eV. For proton the energy would be 8.76 eV. UV photon with energy  $E \geq 8$  eV could kick electrons from large space-time sheets to  $k = 144 = 146 - 4$  space-time sheet where they have zero point kinetic energy of 8 eV plus possible additional energy (for proton the energy would be 8.76 eV). One possibility is that these electrons drop first to  $k = 145$  by the emission of  $\sim 4$  eV UV photon and then to  $k = 144$  by the emission  $\sim 2$  eV photon corresponding to 650 nm line. The further dropping to larger space-time sheets would produce besides this line also the lines with longer wavelengths in the band.

The energy of UV photons brings in mind the bond energy 7.36 eV of  $N_2$  molecule and the possibility of metabolic mechanism using UV light as metabolic energy and based on the dissociation of  $N_2$  followed by re-association liberating metabolic energy kicking protons or electrons to a smaller space-time sheet. For the  $k \rightarrow k + 3$  transition of electron the energy would be 7 eV which suggests that this transition defines important metabolic energy quantum for living interstellar dust using dissociation and its reversal as basic metabolic mechanism.

### 3.3.2 Laboratory evidence for plasmoids as life forms

Accepting the notion of magnetic body one is naturally led to the idea about plasmoids as primitive life forms quantum controlled by the dark matter at the magnetic body of the plasma ball. Magnetic body itself would contain Bose-Einstein condensates of ions and electrons and could be seen as a quantum plasmoid. Plasmoids would be very simple systems able to recycled metabolism and therefore highly interesting from the point of new energy technologies. Magnetic body of the plasmoid could also be responsible for a continual feed of charge keeping plasma ball charged (DNA strands are negatively charged in bio-matter).

#### From dust to dust

The article *From Plasma crystals and helical structures towards inorganic living matter* of Tsytovich *et al* in August issue of New Journal of Physics provides new empirical support for plasmoids as living life forms. The results of the article suggest that interstellar dust could behave like living matter in some respects: it could even have variant of genetic code. This is a really shattering finding and with single blow destroys the standard dogma about life as something purely chemical. It should also give also some headaches for those influential colleagues who have decided that it is necessary to accept the anthropic principle. Here is little popularization of the result.



*SCIENTISTS have discovered that inorganic material can take on the characteristics of living organisms in space, a development that could transform views of alien life.*

*An international panel from the Russian Academy of Sciences, the Max Planck institute in Germany and the University of Sydney found that galactic dust could form spontaneously into helices and double helices and that the inorganic creations had memory and the power to reproduce themselves.*

*A similar rethinking of prospective alien life is being undertaken by the National Research Council, an advisory body to the US government. It says Nasa should start a search for what it describes as "weird life" - organisms that lack DNA or other molecules found in life on Earth.*

*The new research, to be published this week in the New Journal of Physics, found nonorganic dust, when held in the form of plasma in zero gravity, formed the helical structures found in DNA. The particles are held together by electromagnetic forces that the scientists say could contain a code comparable to the genetic information held in organic matter. It appeared that this code could be transferred to the next generation.*

Professor Greg Morfill, of the Max Planck institute of extra-terrestrial physics, said:

*Going by our current narrow definitions of what life is, it qualifies. The question now is to see if it can evolve to become intelligent. It's a little bit like science fiction at the moment. The potential level of complexity we are looking at is of an amoeba or a plant. I do not believe that the systems we are talking about are life as we know it. We need to define the criteria for what we think of as life much more clearly.*

*It may be that science is starting to study territory already explored by science fiction. The television series The X-Files, for example, has featured life in the form of a silicon-based parasitic spore. The Max Planck experiments were conducted in zero gravity conditions in Germany and on the International Space Station 200 miles above earth.*

*The findings have provoked speculation that the helix could be a common structure that underpins all life, organic and nonorganic.*

To sum up the essentials, plasma phase is involved and the dust life is able to construct analogs of DNA double helices and this has been achieved also in laboratory. "From dust to dust" seems to have a very deep side meaning!

Here is a more quantitative summary of the results reported in [I23] .

1. The scale of the dust balls seems to be few micrometers. It is essential that the system is open in the sense that there is both metabolic energy feed and continual feed of plasma to negatively charged dust particles to preserve their charges. Authors speak about effective "gravitational" instability as a mechanism leading to the formation of the helices and identify effective gravitational coupling (the formula contains a trivial typo) as a function of charge and mass of the particle plus dimensionless parameter characterizing the modification of Debye model implied by the fact that dust particles are not electrically closed systems. Authors give a long list of life-like properties possessed by the helical structures.
2. Helical structures are generated spontaneously and possess negative charges. The repulsion of the helical structures transforms to attraction at some critical distance interval due to the fact that the large electrostatic self energy depends on the distance between helices and this makes possible double helices (authors speak about over-screening in the formal model). Similar mechanism might work also in the case of ordinary DNA double helices whose stability is poorly understood since also in this case the large negative charge could be preserved by continual feed of charge.
3. The twist angle of the helix makes bifurcations as a function of radius of helix and the values of twist angle could define the letters of genetic code. Also a mechanism for how the twist angle is communicated to neighboring helix is proposed. Also dust vortices are observed and might be those which one can occasionally observe during hot summer days.
4. Authors do not mention magnetic fields but my guess is that the helical structures reflect directly the geometry of the helical magnetic flux tubes, and that dark electron pairs with large Planck constant at these tubes might be the quantal aspect of the system. These currents might relate closely to the plasma current, which charges the dust particles. Also DNA, which is insulator, is known to be able to act as conductor, and here the free electron

pairs associated with aromatic rings having  $\hbar = n \times \hbar_0$ ,  $n = 5$  or  $6$ , could make conduction possible since their Compton size would be  $n$ -fold.

### Elephant trunks in astrophysics

TGD Universe is fractal and this means that the visible structures are formed around magnetic flux quanta containing dark matter with large  $\hbar$  appear in all length scales and have geometric patterns reflecting the exact discrete symmetries of dark matter acting as rotational symmetries of the field body and at the level of visible matter giving rise to broken symmetries typical for molecular structures. The helical structures found from the rings of some planets could be one example of fractal life.

For some time ago I learned about "elephant trunks" found by Hubble (I am grateful for Miika Väisälä telling about the trunks and for giving references to the papers about the finding). They appear in very wide range of length scales: at least from 1000 au to 1 pc. They are found in close connection with molecular clouds and HII regions excite by one or more young hot stars (a "metabolic connection" with the above mentioned unidentified bands and lines and PAHs present only if there is also UV source present does not look like a bad guess). In general the trunks are

Another important finding supporting TGD view about Universe which might be seen as a fractally scaled variant of above helices pointing like fingers to the hot stars. Here is abstract of the paper by P. Carlquist, G. F. Gahm, and H. Kristen [I46] .

*Using the 2.6 m Nordic Optical Telescope we have observed a large number of elephant trunks in several regions. Here, we present a small selection of this material consisting of a few large, well-developed trunks, and some smaller ones. We find that: (i) the well-developed trunks are made up of dark filaments and knots which show evidence of twisted structures, (ii) the trunks are connected with essentially two filamentary legs running in V-shape, and (iii) all trunks have the maximum extinction in their heads. We advance a theory of twisted elephant trunks which is based on the presence of magnetic flux ropes in molecular clouds where hot OB stars are formed. If the rope contains a local condensation it may adopt a V-shape as the region around the hot stars expands. If, in addition, the magnetic field in the rope is sufficiently twisted, the rope may form a double helix at the apex of the V. The double helix is identified with the twisted elephant trunks. In order to illustrate the mechanisms behind the double helix we have constructed a mechanical analogy model of the magnetic flux rope in which the rope has been replaced by a bundle of elastic strings loaded by a weight. Experiments with the model clearly show that part of the bundle will transform into a double helix when the twist of the bundle is sufficiently large. We have also worked out a simple theoretical model of a mass-loaded magnetic flux rope. Numerical calculations show that a double helix will indeed form when the twist of the rope exceeds a certain critical limit. Numerical model calculations are applied to both the analogy model experiments and one of the well-developed elephant trunks. On the basis of our model we also suggest a new interpretation of the so called EGGs.*

*The double helix mechanism is quite general, and should be active also in other suitable environments. One such environment may be the shell of supernova remnants. Another example is the expanding bubble outlined by the North Celestial Pole Loop.*

For fractally thinking physicist consisting mostly of dark matter with large Planck constant this does not leave many options: life and even intelligent life is everywhere and in all length scales. This provides also a new view about Fermi paradox: see the article [L4] , which summarizes also the essentials of TGD, TGD based ontology, and TGD based quantum biology.

### 3.3.3 Universal metabolic quanta

The basic prediction following from the p-adic length scales hypothesis is that universal metabolic energy quanta come as octaves of p-adic energy scale. The natural expectation is that the evolution of life has proceeded from high to low energy quanta and that also the high energy quanta might be seen even at the level of organic life.

#### Could UV photons have some metabolic role?

The correlation between UV photons and ERE brings in mind the vision that high temperature plasmoids are primitive life-forms possibly having universal metabolic energy quanta in UV range.

One can imagine that the development of chemical energy storage mechanisms has made it possible to use visible light from Sun as a source of metabolic energy and get rid of UV quanta having disastrous biological effects. Ozone layer shields out most of UV light and also air absorbs the UV light below wavelength 200 nm, which justifies the term vacuum UV (VUV) for this range.

$\Delta k$	1	2	$\geq 3$	$\infty$
$\Delta E(144, \Delta k)/eV$	4	6	$\geq 7$	8
$\lambda/nm$	310(UVB)	207(UVB)	$\leq 177$ (VUV)	155 (VUV)

Table 3. The lines corresponding to the dropping of electron from  $k = 144$  space time sheet defining a candidate for UV light inducing generation of ERE in the interstellar dust.

From Table 3 one finds that  $\Delta k > 2$  electronic transitions cascading to 8 eV (155 nm) by period doubling) belong to vacuum UV (VUV) absorbed by air. The lines 310 nm and 207 nm corresponding to  $\Delta k = 1$  and  $\Delta k = 2$  could however define frequency windows since these lines need not correspond to any atomic or molecular electronic transitions.

In the solar photosphere the temperature is about 5800 K, roughly half of the minimum temperature  $10^4$  K needed to generate the UV radiation inducing ERE in interstellar dust. Solar corona however has temperature of about  $10^6$  K, which corresponds to a thermal energy of order 100 eV and the UV radiation from corona at above mentioned discrete frequencies resulting in dropping of electrons could serve as a metabolic energy source for pre-biotics in the interstellar space. This raises obvious questions. Should the stellar sources inducing ERE possess also corona? Could 4 eV and 6 eV UV photons from the solar corona serve as a source of metabolic energy for some primitive organisms like blue algae?

### A simple model for the metabolism of plasmoids

Extended Red Emissions (EREs) are associated with the interstellar dust in presence of UV light with energies above 7.25 eV and source with temperature not below  $10^4$  K (maximum of wave length distribution of black body radiation corresponds to the energy 4.97 eV at this temperature). This suggests that plasmoids using UV photons as metabolic energy are involved.

1. Since the bond energies of molecules vary in few eV range and their formation typically liberates photons in UV range, the natural hypothesis is that the metabolic cycle is based on the formation of some molecule liberating UV photon kicking electron/proton to a smaller space-time sheet. UV photons from energy source would in turn induce dissociation of the molecule and thus drive the process. The process as a whole would involve several p-adic length scales and several metabolic currencies.
2. This situation is of course encountered also in the ordinary biology but with highly developed sharing of labor. Biosphere would burn hydrocarbons in animal cells with carbon dioxide as the eventual outcome. Carbon dioxide would in turn be used by plants to regenerate the hydrocarbons. Note that in the recent day technology the loop is open: hydrocarbons are burned but there is no process regenerating them: perhaps photons with large Planck constant might some day used to regenerate the fuel and give rise to "living" and perhaps tidier technology.
3. It is believed that complex organic molecules like amino-acids can form in the interstellar dust and the spontaneous formation of amino-acids is known to be possible in the interstellar ice under UV radiation. Hence at least  $N_2$  and perhaps also  $CO$  can be expected to be present. The table below gives dissociation energies of some simple molecules.

Molecule	$H_2$	$O_2$	$N_2$	$CO$	$NO$
$E_D/eV$	4.48	5.08	7.37	11.11	5.2

i)  $N_2$  has bond energy 7.37 eV is slightly above the UV threshold 7.26 eV for ERE, which strongly suggests that  $N_2$  is one of the molecules involved with the metabolism of interstellar

plasmoids.

ii) If ice is present then carbon monoxide  $CO$  would be an excellent candidate for a metabolic molecule since its bond energy is as high as 11.11 eV. The exceptionally large bond energy would naturally relate to the fact that carbon and oxygen are the key molecules of life.

### Anomalous light phenomena as plasmoids

TGD suggests that anomalous light phenomena (ALPs, or light balls, or UFOs depending on one's tastes and assumptions) are identifiable as plasmoids behaving as primitive life forms. In the conference held in Rörörs Björn Gitle-Hauge told about the determination of the spectrum of visible light emitted by some light balls observed in Hessdalen [H26] ("Hessdalen phenomenon" is the term used).

1. The spectrum is a band in the interval 500-600 nm whereas the typical ERE [I52] is concentrated in the interval 650-750 nm. The peak is in the interval 540-900 nm, the width of the band is also now 100 nm, and there are no sharp peaks. Therefore the interpretation as ERE can be considered.
2. Because Hessdalen is an old mining district, authors propose that the light ball could consist of burning dust containing some metals. Author proposes that the burning of Titanium and Scandium (encountered only in Scandinavia) might provide the energy for the light ball.  $Sc$  reacts vigorously with acids and air (burning in oxygen gives  $Sc_2O_3$  as end product).  $Ti$  burns in oxygen and is the only element that burns in nitrogen.  $Ti$  is used in fireworks since it produces spectacular fires.

Author notices that the emission lines of  $N^+$ ,  $Al^{++}$ , *resp.*  $Sc^+$  at 528.02 nm, 528.2 nm, *resp.* 528.576 nm might contribute to the band. This might be the case but the explanation of the band solely in terms of molecular transitions is not favored by its smoothness.

3. The bond energies of  $TiO$  and  $TiN$  are 6.9 eV and 5.23 eV so that the radiation resulting in their formation is in UV range and could provide part of the metabolic energy. I do not know about bond energy of Scandium oxide.
4.  $TiO_2$  is known to catalyze photolysis in the presence of UV light [I8, I9], which in turn is basic step in [I10] [I10], the basic step of which in TGD Universe would be the kicking of electrons/protons to smaller space-time sheets. Therefore the UV photons liberated in the formation of molecules containing  $Ti$  could catalyze photosynthesis like process.

### 3.3.4 Life as a symbiosis of plasmoids and biological life

If evolution has discovered something it usually keeps it so that plasmoids and UV metabolism should be still there. This suggests that plasmoids are still in ionosphere. What could this mean? There also other questions and I am grateful for Sampo Vesterinen for some of them. The key questions are perhaps the following ones. Do plasmoids and biological life forms live in symbiosis in some sense? If this is the case, what plasmoids can give to us and what we can give to plasmoids?

#### 1. Magnetic bodies as quantum plasmoids and plasmoids in magnetosphere

One must make clear what one means with plasmoid. One can consider a plasma made of ordinary visible matter and also large  $\hbar$  quantum plasma at magnetic bodies in a form of Bose-Einstein condensates of charged particles. The symbiosis of plasmoids and biomatter could correspond to the symbiosis of magnetic body and biological body.

One can imagine also the possibility that visible matter plasmoids and bio-matter are in symbiosis via the mediation of magnetic bodies. Note that DNA strands are negatively charged so that there is a resemblance with a plasma like state. One aspect of symbiosis would be that magnetic body would feed charged particles to DNA.

#### 2. Some basic facts about magnetosphere

Magnetosphere would be a natural environment for plasmoid population. If one restricts plasmoids to to visible matter, then ionosphere, plasma sphere and plasma sheet are the most interesting objects of interest.

1. The temperature in the highest F layer of the ionosphere (extending from 150 km to 1500 km depending on source) is about 1200-1300 K: the photon energy is about .6-.65 eV at the maximum wavelength of thermal distribution. Hence F layer plasmoids might receive metabolic energy in the form of .5 eV metabolic energy quanta via thermal photons. Self-organization occurs in transition layers and especially interesting is the transition region 85-300 km from mesosphere to ionosphere at which temperature increases 300 K to about 1200 K.
2. Inner magnetosphere is a torus-like structure whose extension varies between  $4R_E$  (day side) and  $8R_E$  (night side) and shielded from solar wind. In the inner magnetosphere the typical density is about 1 ion per cubic centimeter. Inner magnetosphere is bounded by a transition layer of thickness of  $\sim R$  (magneto-pause). In this region the density of the ions drops rapidly.

Inner magnetosphere contains plasma sphere whose radius varies in the range  $2R_E - 4R_E$  at day side and  $2R_E - 6R_E$  at night side. Plasma has a ionospheric origin. The density of the cold plasma consisting mainly of protons sphere varies in the range  $10 - 10^3$  ions/cm<sup>3</sup>, whereas the temperature is  $\sim 5 \times 10^3$  K, which corresponds to metabolic energy quantum of .5 eV. Note however that the energy of photon at maximum of thermal distribution is about 2.5 eV which suggests 2 eV metabolic quantum.

The cold, dense plasma of plasma sphere is frozen around magnetic flux lines which co-rotate with Earth. In TGD framework this means that flux tubes co-rotate and thus change shape. In the equatorial plane the density of the plasma sphere drops sharply down to  $\sim 1$  ion/cm<sup>3</sup> at  $r = 4R$ . This transition region is known as a plasma pause. During magnetic storms the outer radius decreases since the pressure of the solar wind compresses the plasma sphere. The day-night variation of the shape of the plasma sphere is rather small. Within this region the magnetic field has in a reasonable approximation dipole shape with radiation belts forming an exception.

The surface temperature of Sun is  $6 \times 10^3$  K. This temperature is roughly half of the minimum temperature  $10^4$  K needed for EREs from interstellar dust [I52]. This corresponds to photon energy of 3 eV at the maximum of thermal distribution and cannot induce dissociation of  $N_2$  and other simple diatomic molecules. There is also solar corona but its temperature is about  $10^6$  K ( $10^2$  eV) so that the flux of thermal photons at UV energies is very low.

Taking seriously the finding that  $T \geq 10^4$ K for source is necessary for EREs, one might ask whether the plasmoids at the day side are able to receive enough metabolic energy from UV radiation of Sun. If course, there is no need to assume that dissociation of  $N_2$  molecules is key element in metabolic mechanism. The temperatures in both F layer and plasma sphere allow kicking of protons and electrons to smaller space-time sheets and this might save the situation. Hence metabolism is not a problem for the plasmoids except perhaps during night-time when the plasma cools down somewhat.

3. The plasma sheet [K39], [F6] at the night side of Earth dark is the most prominent feature of the outer magnetosphere. It has a thickness about Earth radius  $R_E$  and extends beyond Moon's orbit (with radius  $10^3 R_E$ ). The average densities of charged particles are very low and same order of magnitude as in plasma sphere: about .4-2 per cm<sup>3</sup> for both protons and electrons and correlates with solar wind density.

The temperature is very high: the thermal energy of electrons is in keV range and ionic temperatures are even higher. The high temperature is due to the leakage of matter from solar wind. Note that up to the distance  $d \sim 10^2 R_E$  equator region of outer magnetosphere at the night side of Earth experiences a continual solar eclipse so that this region does not receive radiation energy from Sun: the high temperature of plasma sheet solves this metabolic problem.

The presence of keV photons would destroy molecules at plasma sheet and induce a high degree of ionization so that plasmoid life must be based on ions and electrons. The energy needed to kick an electron to an atomic space-time sheet is about keV from  $m_e/m_p \sim 2^{-11}$ : hence the dropping of electrons from atomic space-time sheets would be the natural metabolic mechanism for plasmoid life at plasma sheet.

One of the original motivations for the plasmoid hypothesis was the strange finding that plasma sheet at the equator at the dark side of Earth is highly self-organized structure and the velocity distributions of electrons present patterns like "flowers", "eyes", "butterflies" [K39]

3. *What plasmoids could give to us and what we could give to plasmoids?*

An attractive general motivation for the symbiosis would be that magnetic bodies would give us ability to think and we would give them ability to sense.

1. The model of cognitive representations relies on the intersections of magnetic bodies with corresponding p-adic space-time sheets possessing literally infinite size in the real sense. The larger the magnetic body, the better the representations. Magnetic bodies could thus provide us with cognitive representations and an interesting question is whether and how this relates to the strange self-organization patterns at plasma sheet.
2. We could provide for magnetic bodies sensory input and serve as their motor instruments. These magnetic bodies might be also associated with plasma sheet and the plasmoids of ionosphere and plasma sphere and could also use plasmoids of visible matter as a sensory receptors and perhaps even primitive motor instruments.

One can imagine also more concrete motivations for the symbiosis.

1. Plasmoids in the day-side ionosphere could shield biosphere from UV light by "eating" the incoming UV light. Magnetic bodies could also feed negative electronic charge from the plasmoids of magnetosphere to DNA double strands.
2. Plasmoids are not in a need of metabolic energy unless it happens that the temperature in F layer cools too much during night time from  $T \sim 0.12$  eV. One might imagine that plasmoids suck metabolic energy from the biosphere during sleep (say brains which remain active): this would be a possible explanation for why we sleep. One can even imagine that during sleep magnetospheric collective levels of consciousness take command and life forms in the biosphere entangle to form kind of stereo consciousness providing a collective view what is to be human, member of species, or a part of biosphere.

4. *About the interpretation of bio-photons?*

Also the wave lengths of bio-photons are in the range of visible photons. Their spectrum is claimed to be featureless, which would suggest that identification in terms of photons resulting in dropping of electrons and protons to larger space-time sheets might not make sense. The variation of the geometric shape of space-time sheets, the possibility of surplus energy, and the clustering of the transition lines around the lower end of wave length spectrum might however give rise to effectively featureless spectrum.

Suppose that bio-photons correspond to superposition of ERE bands and thus reflect the presence of UV energy feed. Unless biological body is not able to generate the needed UV photons, they must arrive from Sun. Bio-photons or their dark counterparts with much longer wavelengths could indeed live at the flux quanta of the magnetic bodies and observed visible bio-photons could represent some kind of leakage.

5. *Gariaev's experiments*

Gariaev's experiments [I28] involved the irradiation of DNA using visible laser light with photon energy 1.9595 eV. The irradiation induced emission of radio waves with same polarization with frequencies above kHz. Radio waves induced growth of potatoes. A possible interpretation is that 2 eV photons kicked electrons to a smaller space-time sheet and thus gave metabolic energy to DNA. The radio waves possibly resulting in the dropping of electrons back to the larger space-time sheets could have consisted of dark photons with same or smaller energy and could have been used as a metabolic energy by the potatoes. That the dropping can occur to several space-time sheets would explain why several radio wave frequencies were observed. The prediction would be sum of period doubling spectra discussed earlier since sequences of droppings are possible. The

radio-wave signal would result from the de-coherence of dark radio-wave photons to a bundle of ordinary radio-wave photons.

#### 6. *Earth's interior as a living system?*

For years ago I developed in detail the working hypothesis that entire magnetosphere is a living system. Even Earth's interior (and also solar surface) could contain plasmoid life [K27, K39]. The temperature below the mantle of Earth does not differ too much from the surface temperature of Sun and metabolic energy could come from the radioactive decays from the interior of Earth. There would be UV shielding by Earth: UV light has energies above 3.1 eV whereas the temperature at the mantle-core boundary is 4300 K which corresponds to energy 2.2 eV energy at the maximum of thermal distribution. Metabolic energy quantum of 2 eV would be highly suggestive and might be directly used to kick protons and electrons to smaller space-time sheet.

The metabolism would not probably involve energy quantum of .5 eV. Magnetic flux tubes could also mediate metabolic energy from the biosphere and possibly also ionosphere and the plasmoid life in question could be at an evolutionary level not tolerating UV light and involve molecules in essential manner.

### 3.4 Podkletnov effect and Modanese-Podkletnov effect

The name of Podkletnov is associated with two effects for which the simplest explanation seems to be based on the same idea. The older experiment [H44] reports a few per cent effective reduction of strength of Earth's gravitational field above rotating and levitating super-conductor subjected to 1 MHz AC current generated magnetic field. [H50] [H50] reports a similar effect in rotating super-conductor during a phase transition from super-conducting to non-super-conducting phase.

In Modanese-Podkletnov effect [H43] the electric discharges of a capacitor for which the second plate is super-conductor are reported to generate a pulse of unidentified radiation inducing the oscillation of test penduli. What is strange that the beam of radiation does not seem to be attenuated.

I have considered several alternative explanations for the Podkletnov effect but only after having realized the correct interpretation of predicted long ranged electro-weak and color gauge fields in terms of dark matter hierarchy it became obvious that the common denominator of these experiments is phase transition like phenomenon, either (possibly) repeated transition from super-conducting to super-conducting state or dielectric discharge of the super-conductor. This leads to a unique model implying also a close connection with Searl device.

#### 3.4.1 Modanese-Podkletnov effect

E. Podkletnov and G. Modanese have constructed a device [H43] in which a super-conducting ceramic cathode and a copper anode cause electrical discharges in low pressure gases, at temperatures between 50 and 70 K. The voltage used is 2 MV. Peak currents are of order  $10^4$  A. Cathode and anode have radii of 10 cm and their distance varies between 15 and 40 cm. There is also a magnetic field of .9 Tesla present inside the cylindrical chamber to concentrate the discharge to a smaller area. In discharges at voltage above .5 MV two new phenomena were observed. First, discharge does not look like a spark but like a flat, glowing discharge originating from the whole surface of the super-conductor. Secondly, a radiation pulse is emitted at the discharge which propagates orthogonally to the cathode, towards the anode and beyond it, in a collimated beam, apparently without an attention. Radiation pulse carries away an energy of  $10^{-3}$  J at least. It is concluded that the radiation in question cannot be ordinary electromagnetic radiation.

The anomalous radiation was measured using various penduli at the line connecting the centers of cathode and electrode and hanging from a cotton string inside glass cylinders under vacuum. The radii of spheres were 10-25 mm and located at distances 6 m and 150 m from the installation. Various materials for the spheres were used: metal, glass, ceramics, wood, rubber, plastic. It was found that the impact on pendulum did not depend on the material but only on the mass of the pendulum which was in the range 10-50 g. Pendulum did not show any signs of heating. Measurements of the impulse taken at close distance (3-6 m) and large distance (150 m) gave identical results. The pulses were not absorbed by the media or at least, the losses of energy were

negligible. The force beam does not seem to diverge and its borders are clear-cut and the width of the beam is that of the super-conducting emitter. If the pulse propagates in air, some energy should be depleted from it and lead to the weakening of the pulse. The observations of the air in the path of pulse only show that brief forward and backward movement of particles occurs.

The radiation appears to propagate through brick walls and metal plates without a noticeable absorption but this is not due to weak coupling with matter. Ordinary electromagnetic radiation cannot be in question. The assumptions that the radiation satisfies  $E = cp$  dispersion relation and that the pulse given to the penduli is due to the absorption of energy and momentum of radiation leads to a contradiction. For a pendulum of 18.5 g, the kinetic energy of the pendulum was of the order of  $10^{-4}$  J whereas the momentum was of the order of  $10^{-3}$  kg m/s. If this momentum had to be imparted from the beam, its total energy should be larger than the total energy available in the discharge,  $10^6$  J in maximum. The conclusion made in [H43] is that the radiation does not obey the dispersion relation of massless particles. On the other hand, if the net energy and momentum of the pendulum correspond to the total energy and momentum for quanta of radiation absorbed by the pendulum, the quanta must be tachyonic since one has  $E = 10^{-4} J \ll pc = 3 \times 10^5$  J, which suggests that absorption is not the mechanism. Also the fact that radiation does not weaken with distance with a detectable manner suggests the same.

The force is proportional to the mass of the pendulum sphere but the interpretation as a gravitational force is excluded already because of the strength of the effect. Equivalence Principle states also that the gravitational force depends only on the gravitational mass of the particle, not its particular state. The force is also repulsive.

The TGD based explanation for the effect relies on the model of Tesla coil [K90], which assumes that a phase transition of electrons to Cooper pairs of dark electrons takes place about critical voltage  $V_{cr} = m_e$  in presence of oscillating external AC voltage.

1. There is a very strong analogy with the model for what happens in the secondary coil of Tesla transformer [K90]. The critical voltage  $V = .5$  MV above which the Modanese-Podkletnov effect appears corresponds to an electrostatic energy equal to the rest energy of electron, and therefore to the proposed value of  $eV_{cr} = m_e = .5$  MeV for which ohmic current through a Tesla coil transforms to supra current of dark electrons along its surface. This would suggest that ordinary local dielectric breakdown transformed to global a super-conducting dielectric breakdown involving the flow of supra current of dark electronic Cooper pairs from the superconducting disk to the non-superconducting disk. Also a beam of dark photons are generated but at this time they would not be visible. This could be understood if their energies are not equal to those of visible photons or if the beam is concentrated very strongly in the forward direction so that the dark photons do not reach retina of observed not in the path of the beam. Similar global dielectric breakdown as supra current between secondary of the Tesla coil and ground in the case of Tesla's experiments would correspond to the white light filling the room [K90].
2. The radiation could correspond to a massless extremal (ME, 'topological light ray') or possibly existing TGD counterpart of the longitudinal scalar waves of Tesla. The classical field involved could be either electromagnetic or  $Z^0$  type. MEs are space-time correlates for completely collimated radiation propagating with light velocity with pulse shape being arbitrary and preserved. The possibly existing Tesla wave represents longitudinal pulse of electric or  $Z^0$  electric) field propagating with light velocity. At least  $Z^0$  type and perhaps also dark em MEs and scalar waves do not care about Faraday cages: the classical radiation is simply at another space-time sheet. This fits with the observation that the pulse of radiation goes through various obstacles without absorption.
3. One can argue that electromagnetic Tesla's scalar waves are favored because their emission could be interpreted as a decay of the electric field of the capacitor by the emission of scalar waves carrying away pieces of space-time containing a constant electric field with intensity equal to the local intensity of the electric field between the capacitor plates. For the scalar wave pulses the quantization of the electric flux analogous to that of magnetic flux suggests that the condition

$$eVL = eEL^2 = n \times 2\pi \ ,$$



$n$  integer, is satisfied ( $\hbar = c = 1$ ), so that the length of the scalar wave pulse would be  $L = \sqrt{n2\pi/eE}$ . For an electric field having a magnitude of order  $E \sim 10^4 kV/m$  (a voltage of  $10^4$  kV over a distance of 10 cm) and for  $n = 1$  the scalar wave pulse would have a length of about one micrometer.

4. What might cause the repulsive force proportional to the mass of the object?  $E = pc$  relationship does not hold for the energy transfer: rather momentum is much larger than this would allow. Thus an absorption of massless quanta is certainly not in question. Rather, the relationship suggests an ordinary non-relativistic dispersion relation between kinetic energy and momentum for a massive particle. The total mass of these particles is from numbers  $\Delta E = 10^{-4}$  J and  $\Delta p = 10^{-3}$  kgm/s equals to about 50 grams. The actual mass mentioned in the example was 18.5 grams. This makes perfect sense since only order of magnitude estimate is in question.
5. Many-sheeted space-time suggests a different explanation for the effect consistent with  $E = cp$  relationship. The effect would be actually a special case of anomalies which are very abundant and explained by the many-sheeted space-time concept.
  - (a) The space-time sheet of the pulse would act as a temporary bridge between two space-time sheets, say an atomic space-time sheet of the test object and a super-conducting magnetic flux tube of the Earth's magnetic field or its dark counterpart [K22]. Some particles from the atomic space-time sheets of the test object leak along this bridge to a larger space-time sheet or vice versa. The presence of the leaking particles at the bridge would make it temporarily massive and stop the motion of ME/scalar wave pulse for a moment. Since absorption does not occur considerably this should occur only temporarily. In case of the scalar wave pulse the longitudinal electric field would define a force field and induce ionic currents of opposite sign between the space-time sheets.
  - (b) If the particles leak to the direction of the emitter first, as is natural since the join along boundaries bonds are first formed to this direction, then effective repulsive force results as a recoil effect by conservation of total momentum holding in many-sheeted space-time but not for single space-time sheet anymore. Recoil momentum is indeed non-vanishing since the zero point kinetic energy of particles at atomic space-time sheets is non-vanishing and is transformed to the kinetic energy of the particles at the larger space-time sheet. An order of magnitude estimate is obtained by assuming that the 'dropping' particles are electrons, and that the zero point kinetic energy is  $E = \pi^2/2m_e L^2 \simeq 1$  keV resulting, when the size  $L$  of the atomic space-time sheet is one Angstrom. This gives for the fraction  $\epsilon$  of electrons in the pendulum transferred to the beam space-time sheet the estimate  $\epsilon \simeq 1.8 \times 10^{-10}$ .
  - (c) If the probability for leakage is same for all particles independent of the material, the recoil momentum of the object resulting from the leakage of particle to another space-time sheet is proportional to the mass of the object as observed.

A possible test for this effect is following one. The object should lose some mass via the leakage, at least temporarily. The loss of mass is predicted to be small, a fraction of order  $10^{-13}$  about the mass of the pendulum. One could also look whether the pendulum becomes charged in the process. The leakage of the super-conducting ions from the magnetic flux tubes of say Earth to the atomic space-time sheets is a fundamental mechanism of breaking of super-conductivity in TGD universe. The quantum theory of bio-systems relies on this mechanism as well as TGD based explanations for certain free energy phenomena like Brown gas [K34]. The 'miraculous' appearance of ions or atoms to system originally not containing them by supra current leakage from magnetic flux tube space-time sheets (say) is the basic testable prediction.

### 3.4.2 Scalar waves of Tesla in TGD framework

The scalar waves or so called non-Hertzian waves of Nikola Tesla belong to the fringe region of science. Many proponents of free energy believe that scalar waves might provide a basis for a new energy and communication technologies. Tesla himself was isolated from the official science

and found no place in text books because his hypothesis about scalar waves did not fit within the framework of the Maxwell's electrodynamics. Personally I justified my personal prejudices against scalar waves by the observation that the formulations for the notion of scalar waves that I had seen seemed to be in a conflict with the cherished gauge invariance of gauge theories. The discussions with a Finnish free energy enthusiast Juha Hartikka however led me to reconsider the status of the scalar waves.

The surprise was that the non-Hertzian waves of Tesla might be possible in TGD framework. The most plausible explanation relies on many-sheeted space-time whereas the original single-sheeted model for scalar waves is too formal to be taken seriously.

1. TGD allows so called massless extremals (MEs, topological light rays) as non-linear generalization of Maxwellian plane waves. They are characterized by light-like wave vector and polarization vector orthogonal to it and these vectors can also depend on space-time position [K10]. The most general wave is a pulse with arbitrary profile moving along ME with light-velocity along them and preserving its shape.

Since TGD space-time is many-sheeted one can take two waves of this kind on top of each other in the sense that their  $M^4$  projections intersect in some region of  $M^4$ . The effective space-time is defined by a piece of Minkowski space with effective metric which is sum of  $M^4$  metric and deviations of the metrics of sheets from  $M^4$  metric. Effective gauge potentials are sums of the induced gauge potentials. For two MEs the potentials at the two sheets and if the wave vectors can be chosen to be in opposite direction in which case one obtains an effective standing wave with non-vanishing net energy but vanishing 3-momentum and classical spin. Since MEs can carry light-like charge current the resulting system carries non-vanishing charge density and vanishing current. Fourier transforms of the pair give rise to massive spinless states having identification as scalar waves possibly carrying em charge.

In TGD framework classical gauge boson fields of standard model correspond two-sheeted structures - perhaps pairs of MEs connected by wormhole contact pairs having interpretation as gauge boson. One can consider the possibility that the classical space-time correlate for gauge bosons massivation at the level of MEs is this kind of pair of spacetime sheets. For massive gauge bosons the wave vector directions of the two sheets would be opposite in the rest system and spin would be vanishing.

2. The original proposal could have been inspired by the electric-magnetic duality of TGD suggesting a large number of solutions of field equations representing constant energy density configurations of electric field assignable to bio-electrets, which would be in a well-defined sense dual to the magnetic flux tube structures with analogous properties. Also classical gravitational fields generated by classical field energy could be important in the living matter. One must however take this proposal with a big grain of salt since there is no proof for the actual existence of this kind of solutions. Furthermore, one can obtain TGD counterparts of scalar waves as pairs of MEs.

### 3.4.3 Podkletnov effect

Podkletnov discovered his effect while working in Tampere University. The report created quite a furor forcing Podkletnov to leave Finland.

#### Observations

The observations of Podkletnov *et al* [H44] (<http://arxiv.org/abs/cond-mat/9701074>) are summarized nicely in [H35] .

1. The effect is observed with double layered toroidal disks, which are high  $T_c$  super-conductors. The lower layer is in non-super-conducting state whereas the upper layer is in super-conducting state. Super conductivity is essential for the effect. Two-layered structure is known to be essential prerequisite for the effect: for single super-conducting disk the effect is not observed.
2. The disk is levitating in a vertical magnetic field  $B$  created by AC currents in solenoids along the rim of the super-conductor with frequencies of order MHz. Disk also rotates with

a rotation velocity of 5000 rpm. Rotation velocities correspond to velocities of order  $10\text{ m/s}$  at the boundaries of the disk. The effect of the addition of non-rotating radial magnets to the rim of the rotating disk creating a vertical magnetic field  $B_R$  rotating with respect to the superconductor is also studied.

3. Effective shielding of the gravitational field of Earth by about one per cent is reported.  $g$  is reduced in a cylindrical region above the disk but not below it. The best shielding is achieved with frequencies of order 1 MHz. The effect disappears shortly after the turning off of the AC current but not instantaneously. Periodic time variation seems to be essential for the effect, which seems to be largest when heating of the super-conductor is largest. The weight loss is reported to be .05 per cent near rim and .3 per cent at center. The presence of the rotating magnetic field  $B_R$  enhances the effect to 2.1 per cent in the center.

What Schnurer [H50] observed was a slight reduction (or order one per cent) of the weight of the test mass above super-conducting disk levitating in a static magnetic field. High temperature super conductor was used also now but it did not possess two-layered structure. Super-conducting disk was not rotating. The effect was observed only during the super-conducting to non-super-conducting phase transition.

### TGD based explanation of Podkletnov effect

The common denominator of experiments of Podkletnov and Schnurer could be the occurrence of a phase transition like phenomenon, repeatedly in Podkletnov's experiment or just once in Schuner's experiment.

1. The conservative assumption is that no anti-gravitational effect is involved. Rather, kinetic energy and momentum in vertical direction is pumped to the air from super-conductor somehow.
2. This pumping must relate to the time variation of the AC magnetic field used for levitation. In the first approximation the levitating force can be thought as being caused by the vertical gradient of the negative of the magnetic energy contained by the volume of super-conductor. Since AC magnetic field is in question this energy varies between zero and maximum value. Hence the also the magnitude of the force varies periodically and induces a small oscillation of the vertical position of the disk with frequency of order MHz. Already this implies that momentum in vertical direction is pumped to the environment but Schnurer's experiment suggests that situation is not so simple. This model also fails to explain why only the air only above the disk begins to move. Maybe a partial phase transition to non-superconducting phase could make possible the energy to air above the disk.
3. If a partial phase transition to non-superconducting phase occurs by leakage of the magnetic flux tubes to super-conducting layer, it also reduces superconducting volume and the magnetic energy assignable to it. If the Cooper pairs of the high  $T_c$  superconductor are in a phase with large value of effective Planck constant  $h_{eff}$ , they could leak out from the super-conductor as dark supra currents and later transform to ordinary electrons, and in this manner transfer vertical momentum only to the air above the disk. This would imply effective weakening of the gravitational acceleration.
4. The value of  $h_{eff}/h$  should be expressible as a ratio of two natural frequencies associated with the system. The AC frequency  $f_{AC}$  associated with the magnetic field is certainly a natural candidate in this respect. The rotation frequency  $f_{rot} = 83\text{ Hz}$  of the disk is second natural frequency. Their ratio would give for  $f_{AC} = 1\text{ MHz}$   $h_{eff}/h \simeq 10^6/83 \simeq 12048$ . Electron's Compton length  $\lambda_c = 2.4 \times 10^{-12}$  would scale up to 29 nm. Also dark radio wave photons with energy corresponding to that for ordinary photon with frequency  $f_{AC}$  and frequency  $f_{rot} = 83\text{ Hz}$  would be generated but the rate of energy transfer in this manner would be very low.

### 3.4.4 Biefeld-Brown effect, lifters, corona wind, and Modanese-Podkletnov effect

The so called lifters (see the free energy home page of Jean Louis Naudin [H9] ) might one day symbolize the deepness of the crisis of recent day reductionistic physics. M-theory cosmologists are studying what possibly happened before big bang (they can say very little about what happened after the big bang). At the same time school boys are doing new experimental physics by building and studying lifters. Perhaps experimental physics is experiencing a new renaissance outside academic Big Science suffering of intellectual paralysis. Of course, this process is made possible only by the internet allowing to circumvent the censorship of the academic bullies. Lifters rely on Biefeld-Brown effect, which is poorly understood in standard physics context. Since high voltages, corona discharges and corona wind are involved, the obvious guess is that Modanese-Podkletnov effect could be involved with lifter mechanism. This indeed might be the case although the first guess for the lifter mechanism turned out to be wrong.

#### Biefeld-Brown effect

For long time ago T. T. Brown observed [H10, H19, H48] that when capacitor plates are loaded with opposite charges by coupling the capacitor to a voltage source, it jumps to the direction of the second plate. The magnitude of the effect depends on the voltage and begins to decrease above some critical voltage and eventually changes its sign. What is strange is that neither energy nor momentum conservation do not seem to hold true if one assumes that only electric energy is liberated: momentum and energy simply seem to appear from nowhere.

The physics of Biefeld-Brown effect is not understood. Thus one might think that an equipment which can be build by school boys would have been built by some physicist long ago. Also one might imagine that some theoretical physicist might have written an article or even two about the phenomenon during this half century which led to TOEs (Theories Of Everything, often regarded as the end of physics!). The fact is that there is only a quite recent article by Thomas Bahler and Chris Fazi of US Army Laboratory about the phenomenon [H17]. These researchers checked that the phenomenon is real, and by doing a little calculation demonstrated that the standard physics explanation in terms of ionic wind predicts roughly  $10^5$  times too small an effect.

In Wikipedia one finds the following explanation of the Biefeld-Brown effect ([http://en.wikipedia.org/wiki/BiefeldBrown\\_effect](http://en.wikipedia.org/wiki/BiefeldBrown_effect)).

*The effect is generally believed to rely on corona discharge, which allows air molecules to become ionized near sharp points and edges. Usually, two electrodes are used with a high voltage between them, ranging from a few kilovolts and up to megavolt levels, where one electrode is small or sharp, and the other larger and smoother. The most effective distance between electrodes occurs at an electric potential gradient of about 10 kV/cm, which is just below the nominal breakdown voltage of air between two sharp points, at a current density level usually referred to as the saturated corona current condition. This creates a high field gradient around the smaller, positively charged electrode. Around this electrode, ionization occurs, that is, electrons are stripped from the atoms in the surrounding medium; they are literally pulled right off by the electrode's charge.*

*This leaves a cloud of positively charged ions in the medium, which are attracted to the negative smooth electrode by Coulomb's Law, where they are neutralized again. This produces an equally scaled opposing force in the lower electrode. This effect can be used for propulsion (see EHD thruster), fluid pumps and recently also in EHD cooling systems. The velocity achievable by such setups is limited by the momentum achievable by the ionized air, which is reduced by ion impact with neutral air. A theoretical derivation of this force has been proposed (see the external links below).*

*However, this effect works using either polarity for the electrodes: the small or thin electrode can be either positive or negative, and the larger electrode must have the opposite polarity. On many experimental sites it is reported that the thrust effect of a lifter is actually a bit stronger when the small electrode is the positive one. This is possibly an effect of the differences between the ionization energy and electron affinity energy of the constituent parts of air; thus the ease of which ions are created at the 'sharp' electrode.*

According to this explanation the forces on the plates would be due to the electrons and ions rushing on them from the dielectric between the plates and would tend to *increase* the distance

of the plates. The effect however changes sign at high voltages suggesting that additional and stronger contributions are involved as suggested also by the calculations of Bahler and Fazi. The following TGD inspired model would explain why the plates are effectively attracted to each other at high voltages.

1. Perhaps the simplest TGD inspired interpretation assumes that above critical voltage  $eV_{cr} = m_e$  [K90] some portion of the current giving rise to the loading of the capacitor is realized as a supra current consisting of dark electron pairs. As in the case of Tesla coil, the supra phase would result as the electrons rush from the DC source and generate constant negative charge density to the wire leading to that plate of the capacitor that becomes negatively charged. This would generate super-conducting phase and supra current and the wire would be in constant Josephson potential  $V_J$  with respect to Earth. The second wire would carry holes from the opposite plate to the DC source and there would no superconductivity in this case. Recoil effect would result also now.
2. The model for Tesla coil discussed in [K90] suggests that the phenomenon occurs only when the voltage along the wire connecting DC source and negative capacitor plate is above some critical voltage  $V_{cr}$ . The highest voltages involved are measured in MeVs and the proposed value of critical voltage is  $eV_{cr} = m_e = .5$  MeV. What makes  $eV_{cr} = m_e$  special is that the interaction energy with electric field becomes larger than electron mass for this energy and this can lead to the change of the sign of net energy. Support for this hypothesis comes from Modanese-Podkletnov effect which occurs above  $V_{cr}$  [K90].
3. The absence of dissipation means that the energy and momentum of dark electronic Cooper pairs is higher than usually. For super-conducting Cooper pairs the energy gain is  $ZeV$  so that they can become relativistic. As the Cooper pairs enter the capacitor plate they become ordinary conduction electrons and give their momentum to center of mass degrees of freedom of the plate as crystal momentum. This would cause unexpectedly large recoil momentum and energy. Same kind of recoil effect takes place when the electronic holes leave the opposite plate. An analogous effect is also observed for lifters [H8] and similar explanation might apply.

### What lifters are?

Lifter (see the free energy home page of Jean Louis [H9] [H9] ) has an extremely simple structure: asymmetric pair of oppositely charged electrodes. The first electrode could be a planar foil and second electrode just a conducting wire somehow fixed to the larger electrode using some insulating material. When this capacitor is charged to a voltage about 30 kV it lifts to air. The force is in the direction of the smaller electrode. The presence of a small discharge current between the electrodes could be essential for the effect.

The Biefeld-Brown effect [H10, H19, H48] might be behind the lifter effect. The proposed model [K34] for the Biefeld-Brown effect is based on the leakage of the ions from the space-time sheets of the capacitor plates to a larger space-time sheet resulting in a recoil effect. This kind of effect can occur during the charging of the capacitor since there are ionic currents running to the plates. The different masses for ions of opposite charge would cause the effect even in the case that capacitor plates are identical. In this case the direction of the force would depend on the sign of the voltage. Brown reported that there is a correlation of the effect with the sign of the charge but that the motion is always in the direction of the smaller electrode.

On the other hand, the lifter experiments have shown that the sign of the voltage does not have a detectable effect. The effect is possible also for a constant voltage. Some of the ions of the leakage current flowing between the plates through the di-electric could leak to a larger space-time sheet as they enter the second electrode but this would predict the dependence of the effect on the sign of voltage.

The obvious question is whether the mechanism explaining the finding of Modanese and Podkletnov [H43] described in previous section might also be involved the lifter effect, and thus provide a further support for the view that either MEs or the scalar waves of Tesla, discovered for a century ago and completely neglected by the academic physicists, are involved. Also the so called corona wind, which has been used for centuries for entertainment purposes and explained fluently as an amusing curiosity caused by ionic wind could involve MEs or Tesla's scalar waves.

### What causes the lifter effect?

Juha Hartikka [H8] has constructed a lifter consisting of two equilateral triangles on top of each other. The upper triangle consists of a copper wire with radius  $r(\text{small}) = .03$  mm, and the low triangle of straws with an aluminium folio around them, and having radius  $r(\text{big}) = 1.5$  mm. The length of the side of the triangle is  $L = 2.11$  cm (this not of significance now), and the distance between the electrodes is  $D = 2.4$  cm. The total mass of the system is .854 g. The contribution of the copper wire to the mass is  $M(\text{small}) = .45$  g in the approximation that the density is one atom per Angstrom<sup>3</sup> so that the masses of the electrodes are roughly the same.

The most important general findings are following. There is a considerable power expenditure, up to 8 Watts. According to the standard physics expectation this power would be needed to maintain the airflow and to the motion of the lifter. Corona discharge at the wire electrode accompanies the effect, and when corona flow appears at the larger electrode, the effect gets weaker. This suggests a recoil effect appearing only, when the corona discharge is present. Critical voltage is required and sharp edges help to achieve this. The effect is also accompanied by a generation of sounds. The thin electrode is also oscillating in an irregular manner and is curved outside as if experiencing an upwards directed recoil force. Also radio wave emission has been detected.

What could cause the lifter effect?

1. The scalar waves of Tesla could cause the motion of the air by the Modanese-Podkletnov effect. If they cause also the motion of the lifter, both electrodes must emit scalar waves and the small electrode must experience a stronger force. The correlation with the corona discharge however suggests that there is no emission of the scalar waves from the larger electrode, and that the presence of the emission weakens the effect. This would suggest that only the motion of air can be due to the scalar waves.
2. Could the recoil effect be due to the emission of Tesla's scalar waves, when corona discharge is present? In this case the effect would not depend on the sign of the voltage. If the scalar wave pulses leave the lifter with light velocity, the requirement that the gravitational force  $mg$  is compensated by the recoil momentum feed, would give  $mg = W/c$ . For  $m \sim 1$  g this would require a power feed  $W \sim 10^6$  W.  $W$  is found to be below 8 W in the experiments of Juha Hartikka [H8]. Therefore this option is definitely excluded.
3. If one substitutes sound velocity  $v \simeq 10^{-6}c$  for  $c$ ,

$$mg = \frac{W}{v} ,$$

one obtains  $W \sim 3$  Watts for  $m = 1$  g for the needed power feed and this is below the total power feed. Sound wave emission has been observed. Could the recoil effect be associated with the sparks responsible for the plasma discharge? The sparks would be lightning like exploding plasma regions generated by the ionizing charge flow and generating spherical shock waves during their travel. These shock waves in turn kick the smaller electrode. Since the number of ions in the plasma discharge is much larger than the net charge, there is no dependence on the sign of the voltage.

Does this option make sense?  $W = 1$  Watts corresponds to a power of 120 decibels (the formula  $P = 10 \times \log_{10}(W/W_0)$ ,  $W_0 = 10^{-12}$  Watt, gives the power in decibels). The power from Walkman radio to single ear can be as high as 80 decibels. The power to single ear in this case would be a fraction of roughly  $S/4\pi r^2$  of total power, where  $r$  is the distance from the corona discharge and  $S$  is the active receptor area of ear.  $S = cm^2$  and  $r = 1$  m would give factor of order  $10^{-5}$  so that the power to single ear would be something like 70 decibels which sounds too high.

4. The independence of the effect on the sign of the voltage does not support the idea that the recoil would be due to the ions leaving the wire. One can however consider the possibility that the sparks are small plasmoid like structures analogous to ball lightnings. They would emanate from the plasma cloud surrounding the wire electrode and give rise to the recoil effect. The relatively large mass of the plasmoid helps to maximize the strength of the recoil

effect. The numbers of the positive and negative ions in the spark would be much larger than the net charge so that there would be no dependence on the sign of the voltage. This option differs from the option 3) for which sparks are not objects travelling through the air but tracks caused by the ions leaking to the larger electrode.

This alternative is encouraged by the crucial role of the plasmoid like structures in TGD inspired theory of consciousness [K37]. Plasmoid like structures are often accompanied by microwave radiation and Juha Hartikka has indeed detected also the presence of radio wave noise in his experiments [H8]. The emission of the scalar wave pulses would accompany the emission of plasmoids. Note that also in the experiments of Modanese and Podkletnov a coherent leakage current from super conductor having perhaps plasmoid interpretation is observed [H43].

Plasmoids correspond to many-sheeted structures involving super-conducting magnetic flux tubes and atomic space-time sheets with a transfer of ions between various space-time sheets giving rise to and induced by the electromagnetic radiation. The frequency of photons involved corresponds to the difference of the zero point kinetic energies at the space-time sheets involved. For instance, corona glow and radio waves could result in this manner. A considerable part of the leakage current could flow as a supra current, and the recoil effect would result, when a blob of ions from the plasma layer around the thin electrode drops from the atomic space-time sheets to the magnetic flux tubes. This model would actually modify the original model for the Biefeld-Brown effect by replacing ions with blobs of plasma. The same mechanism could also explain why ball lightnings are so stable, that is why their dissipation rate is so low.

### General model for the emission of scalar waves

Consider a situation in which one has a planar electrode and a wire electrode above it, both square-shaped, and such that the wires of the wire electrode are parallel to the sides of the planar electrode. One could allow the electrodes to have different sizes.

1. Modanese and Podkletnov study a full discharge at low temperature from a super-conducting electrode whereas now only a small leakage current appears. One can assume that MEs or the TGD counterparts of the Tesla scalar wave pulses are only above the threshold value  $E_{cr}$  of the electric field above which also corona discharge occurs. MEs/scalar wave pulses are expected to have a much smaller transversal size since the leakage current is not coherent in the length scale of entire electrodes. The power spent by the system would go to the emission of the scalar waves and to the energy dissipated by the plasma discharge, and the power needed to maintain the motion of air and electrodes could be much higher than this power. This obviously provides a crucial test for the model.
2. One could interpret the scalar wave pulse as a quantum of constant electric field analogous to magnetic flux quantum and escaping the system with light velocity. The power goes to the re-building of the electric field. This argument favours scalar wave pulses instead of MEs. In the case of scalar wave pulses the quantization of the electric flux analogous to that of magnetic flux suggests that the condition  $L = \sqrt{n2\pi/eE}$ ,  $n$  integer, is satisfied ( $\hbar = c = 1$ ). For an electric field having a magnitude of order  $E \sim kV/m$  (a voltage of 10 kV over a distance of 10 cm) and for  $n = 1$  scalar wave pulse would have a length of 9 micrometers. The emission of this quantum would accompany the generation of the plasmoid like structure and Modanese effect could be the mechanism giving rise to the leakage of the ions to the magnetic flux tubes of the plasmoid.
3. If the pulses propagate past any object, temporary bridges between the atomic space-time sheet of the object and some larger space-time sheet are formed, and the ions or atoms from the object leak to the latter. This creates a recoil effect giving rise to a repulsive force. In the case of scalar wave pulses the temporary bridge would carry electric field, which could induce ionic currents of opposite sign between the space-time sheets. In this case the effect could depend on the sign of the voltage unless the leaking matter is dominantly neutral. For MEs there would be no such dependence. It would seem that MEs/scalar waves must spend some time in the state in which they act as bridges but must continue their travel after the delay: otherwise absorption would occur. The delay could be due to the fact that the

particles moving along the ME/scalar wave bridge make it temporarily a massive particle so that its motion slows down and almost stops for a while.

4. Also the molecules of the air suffer the same effect and this might be the fundamental cause of the corona wind in neutral air. According to the observations of Juha Hartikka [H8] , the air between the electrodes is indeed set into fan like motion from the wire electrode to planar electrode and the flow is non-vanishing also at the surface of the bigger electrode. This downwards flow could indeed be due to the scalar waves emitted from the corona discharge initiated from the wire electrode and affecting also neutral air molecules. The direction of the airflow and its velocity should not depend strongly on the sign of the voltage. One could test whether the effect obeys the same regularities as the effect found by Modanese and Podkletnov. For instance, air-flow should become stronger, when the strength of the electric field at the small electrode increases, and depend only weakly of at all on the distance between the electrodes. If the effect occurs for large distances between planar and wire electrodes, ionic wind as an explanation of the effect can be excluded. Any sharp edge or corner would generate the air flow effect.
5. Since scalar waves seem to be emitted only from the wire electrode where plasma discharge occurs, one can conclude that Modanese- Podkletnov effect can only reduce the lifter effect by direct force to the larger electrode and by the force caused by the airflow.

The simplest assumption is that scalar wave pulses are emitted in the direction of the field lines at the surface of the electrode when plasma discharges occur. Above the threshold the intensity of the scalar wave pulse beam is most naturally proportional to  $E^2 - E_{cr}^2$ , where  $E_{cr}$  is the field value above which the corona discharge begins and  $E$  is the field at the surface of the electrode. For a planar electrode this means that the beam of the scalar wave pulses is in the vertical direction and has a constant intensity. For the wire electrode the intensity is inversely proportional to the radial distance from the wire.

In the vicinity of the wire electrode the radial field is very strong and at the surface has the magnitude  $E = \sigma_w(\phi)$ , where  $\sigma(\phi)$  is surface charge density, which depends on the azimuthal angle  $\phi$  in the plane orthogonal to the wire,  $\phi$  can be chosen to be zero in the direction pointing to the planar electrode. The intensity of the scalar wave pulses created by the small electrode is in the radial direction and given by

$$I(\phi) = k(E^2 - E_{cr}^2)(\phi) \times \frac{r_w}{\rho} .$$

The intensity is stronger in directions pointing to the larger electrode. The force experienced by a small test object of mass  $m$  is given by

$$F = mI$$

and is in the direction of the scalar wave beam. A test for the hypothesis is whether the local direction of air flow is determined by the directions of field lines at the surface of the electrode or whether the air flow tends to be in the direction of the local electric field.

## 3.5 New hydrogen technologies and new physics

The anomalies related to energy technologies involving the burning of hydrogen to oxygen are known for decades. In fact, the anomaly related to the thermal dissociation of hydrogen was discovered by the Nobel chemist Irving Langmuir for century ago. For some reason these anomalies are not payed any attention in standard chemistry.

### 3.5.1 Anomalies related to the dissociation of water and hydrogen molecules

The burning of hydrogen to water liberates energy. Because the process does not seem to produce chemical pollution, hydrogen provides one of the most promising energy sources. The basic problem is that the storage and transport of hydrogen is very expensive. A possible solution to the problem is to produce the hydrogen by the dissociation of water at the location where the energy is used.



If this goal is achieved, an outcome is an energy source able to compete with other energy sources most of which will be depleted in any case.

The theoretical problem related to various methods producing hydrogen by dissociation of water is in the nutshell that the dissociation of water requires less energy than one might think knowing the bond energies of O-H bonds [D28, D34]. Concerning the basic goal this is of course not a problem. Also the energy needed to dissociate hydrogen thermally is smaller than the binding energy of the hydrogen molecule. This was observed already by Nobel chemist Langmuir for century ago [D30]. For some reason this observation has not received the recognition it would have deserved. Energy flows to the system in both situations and one should understand the origin of this energy.

The zero point kinetic energy of vacuum (ZPE) [D36] has been proposed as a solution the problem. Unfortunately, ZPE theories are not very well defined and far from practically applicable. My intention in the following is to find whether the new physics predicted by TGD might allow to understand the origin of the above mentioned anomalies.

A good guideline is the observation that very many free energy systems involve sharp pulse sequences. Often bi-filar coils invented by Tesla [H53] are involved. The liberation of the zero point kinetic energy when particles drop to a larger space-time sheet is a universal liberation of mechanism of energy justifying the notion of free energy. The time mirror mechanism makes possible the control of this process. Either the system needing the energy or controlling the liberation of energy generates negative energy topological light rays accompanied by negative energy photons (generated by a light like vacuum 4-current possibly associated with the topological light ray). Scalar wave pulses could in turn make possible higher level control by inducing the generation of negative energy topological light rays and photons as time reversed version of brehmstrahlung when charged particles are accelerated in the strong electric field of the scalar wave pulse without dissipation.

These ingredients lead to a concrete model for how the origin of the energy liberated in the dissociation of water and to a proposal how this method could be made more effective. If the proposed explanation is correct, the dissociation of water molecules could be induced also by the irradiation of water by phase conjugate laser light, whose frequencies could be fine tuned to correspond to the needed frequencies. This could mean considerable energy savings.

In the following the model explaining the anomalies related to the dissociation of water and hydrogen is discussed. Also a TGD based justification for the notion of hydrino-atom introduced by Randell Mills [D23] is proposed.

### 3.5.2 The anomalies associated with the dissociation of water molecules

In the sequel the general ideas about time mirror mechanism and many-sheeted lasers is applied to the anomalies observed in the dissociation of water.

#### Constraints on the model of anomalies found in the electrolysis and plasma electrolysis of water

The general theory leaves a lot of freedom for the building of a detailed model. There are however several facts, which provide constraints on the imagination.

1. In plasma electrolysis a pulsed electronic current is an essential part of the process. The natural guess is that the dropping of electrons to larger space-time sheets could excite O-H bonds or O and H atoms to higher energy states. This could happen during the dissociation of the water molecule or already before it. Prof. Kanarev has proposed that the O-H bonds of water molecule are indeed excited before the process. Kanarev has also suggested a separate mechanism in which two electrons join to the water molecule during the dissociation. This mechanism is not needed if the sole role of the electronic current is excitation of the O-H bonds.

In many-sheeted space-time particles topologically condense at all space-time sheets having projection to given region of space-time so that this option makes sense only near the boundaries of space-time sheet of a given system. Also p-adic phase transition increasing the size of the space-time sheet could take place and the liberated energy would correspond to

the reduction of zero point kinetic energy. Particles could be transferred from a portion of magnetic flux tube portion to another one with different value of magnetic field and possibly also of Planck constant  $h_{eff}$  so that cyclotron energy would be liberated. In the following only the "dropping" option is discussed.

2. In very many free energy phenomena a pulsed voltage/current seem to induce the generation of negative energy topological light rays (photons). They in turn would serve as a control signal inducing the generation of positive energy topological light rays (photons) as population inverted many-sheeted laser returns to the ground state. The mechanism generating the phase transition is the same as in the induced emission. This would support the model of Prof. Kanarev: the positive energy photons (analogous to laser beam) would excite the O-H bonds or O and H atoms of the water molecules. Electrons have both thermal and ordered kinetic energy. This means that the energy liberated in the dropping process varies and that the liberated energy can be larger than the zero point kinetic energy. An energy continuum results and makes it possible to excite O and H atoms having a sharply defined transition energies. One can also imagine that so called seesaw mechanism is at work. Negative energy topological light rays would be created in a transition which is the reversal for that producing positive energy topological light rays. Fine tuning would be automatic now. This mechanism might be a central part of bio-control.
3. If the amplification of negative energy signal is based on the mechanism of induced emission, the particles involved must be bosons. Only the Cooper pairs of electrons come into consideration now. In the case of fermions one might think that the dropping of fermions from a given space-time sheet creates free vacancies and makes possible the dropping of fermions to this space-time sheet from smaller space-time sheets. This could induce kind of a chain reaction proceeding from long to short p-adic length scales.
4. The second option is that water molecule emits negative energy photons when it dissociates so that the oxygen and hydrogen atoms of O-H bonds are excited to a higher energy state. This option does not allow to understand the role of the pulse current serving as external controller of the process.

### Zero point kinetic energies

If the kinetic energy of the dropping electrons can be neglected, the spectrum for the energy quanta liberated in the dropping process is universal since zero point kinetic energies are fixed by p-adic length scale hypothesis apart from a numerical factor near unity characterizing the shape of the space-time sheet. The formula for the zero point kinetic energy in the non-relativistic case reads as

$$\begin{aligned} E_0(k) &= n \times \frac{\pi^2}{2mL(k)^2} , \\ L(k) &= 2^{(k-151)/2} \times L(151) , \quad L(151) \simeq 10 \text{ nm} . \end{aligned} \tag{3.5.1}$$

Here  $m$  denotes the mass of the particle and  $n$  is a numerical constant near one.

Atomic space-time sheet  $k = 137$  corresponds in the case of proton to an energy of about .4 eV, which is the basic energy currency of metabolism. This inspires the idea that the basic function of the ADP-ATP system is to drive protons from larger space-time sheets to the atomic space-time sheets by utilizing the chemically stored energy. From this space-time sheet they drop back to the larger space-time sheets liberating the zero point kinetic energy  $E_p(137) \simeq .4 \text{ eV}$  . An entire hierarchy of metabolic currencies is actually predicted [K82, K34] .

Also electrons and their Cooper pairs can drop to larger space-time sheets and in this case the liberated zero point kinetic energy is larger by a factor  $m_p/m_e \simeq 2^{11}$ . The zero point kinetic energy at  $k = 137$  space-time sheet  $\sim .4 - .5 \text{ eV}$  is a convenient unit, in terms of which one can express the zero point kinetic energies of proton, electron, electronic and protonic Cooper pair.

$$\begin{aligned}
 E_p(k) &= 2^{137-k} \times .5 \text{ eV} , \\
 E_{2p}(k) &= 2^{137-k-1} \times .5 \text{ eV} , \\
 E_e(k) &= 2^{148-k} \times .5 \text{ eV} , \\
 E_{2e}(k) &= 2^{147-k} \times .5 \text{ eV} .
 \end{aligned}
 \tag{3.5.2}$$

Here the nominal value of .5 eV for  $E_p(137)$  is used.

**Consistency conditions**

A natural consistency condition is that the thermal de Broglie wave length  $\lambda_{dB} = \pi/\sqrt{2MT}$ , where  $M$  denotes the mass of the heaviest particle at particular space-time sheet, is of the same order of magnitude as the p-adic length scale characterizing the size scale for the space-time sheet from which the particle drops.

$$\lambda_{dB} = \frac{\pi}{\sqrt{2MT}} \sim L(k) .
 \tag{3.5.3}$$

On the other hand, super conductivity requires that thermal energy is smaller than the zero point kinetic energy defining the basic energy unit. This gives the condition

$$\lambda_{dB} > L(k) .
 \tag{3.5.4}$$

Here one must however require that there is no allowed p-adic length scale between  $\lambda_{dB}$  and  $L(k)$ . What "allowed" means is quite not obvious. The first extreme corresponds to the situation in which all values of the integer  $k$  are possible so that p-adic length scales come in half octaves and that all n-ary p-adic length scales are possible. The second extreme corresponds to the situation in which  $k$  is prime. At least secondary p-adic length scales ( $k$  is two times prime) are allowed, and the model of EEG suggests that all values of  $k$  are possible but that those values which correspond to highest cognitive level are the most important ones (every prime factor  $k_i$  in the decomposition of  $k$  to a product of primes defines a  $k_i$ -bit cognitivecode [K60] ).

**Experimental data**

The experimental values for the reduction of the binding energy of water allow to estimate the integer  $k$  characterizing the space-time sheets from which electrons or their Cooper pairs drop.

1. In the ordinary electrolysis the energy needed to dissociate O-H bond has been found to be only 1/3 of the binding energy  $E_w \sim 10$  eV of the water molecule. The reduction of the binding energy is  $\Delta E_w \simeq 6.66$  eV.
2. In the plasma electrolysis of Prof. Kanarev the energy needed to dissociate water molecule is only  $\sim .5$  eV and the effective reduction of the binding energy is as high as  $\Delta E_B \sim 9.5$  eV.

A rough approximation for the energy needed would be 8 eV in both cases. This energy is  $2^4 = 16$  higher than the zero point kinetic energy of proton at  $k = 137$  space-time sheet. In plasma electrolysis the temperature is in the interval  $.5 \times 10^4$ -  $10^4$  C and around  $10^3$  C in the ordinary electrolysis.

**The four options**

One can distinguish between four different models depending on what the reaction mechanism is and whether the energy is donated by electron or electronic Cooper pair.

1. The energy is donated to O-H bond. The ratio  $r$  is predicted to be  $r = 3.33$  and  $r = 4.75$  corresponding to ordinary and plasma electrolysis. The rough estimate is  $r = 4$ .

2. The energy is donated to the entire water molecule. In this case the ratio of the donated energy to the zero point kinetic energy is  $r = 6.66$  in the usual electrolysis and  $r = 9.5$  in plasma electrolysis. The rough estimate is  $r = 8$ .

Furthermore, one can distinguish between two cases according to whether the energy is donated by i) electronic Cooper pairs or ii) electrons. The first option is supported by quantum coherence implying that reaction rate would be proportional to the square of the number of the dropped electronic Cooper pairs. Also the mechanism of the induced emission works for Cooper pairs unlike in the electronic case. It is however better to keep mind open for both options at this stage.

### Analysis and conclusions

The following represents the analysis of the four options.

#### 1. Energy is used to excite only single O-H bond

1. For electronic Cooper pairs the condition  $r = 4$  gives  $k = 142 = 2 \times 71$  corresponding to the secondary p-adic length scale  $L(2, 71) = .56$  nm. The estimate for the thermal de-Broglie wave length in plasma electrolysis is  $.7 - 1$  nm. In the ordinary electrolysis de-Broglie wavelength is roughly 2 times longer. In both cases the thermal de Broglie wavelength is longer than the p-adic length scale so that the necessary condition for super-conductivity is satisfied.
2. In the electronic case the condition  $r = 4$  gives for the p-adic length scale the estimate  $k = 143 = 11 \times 13 \simeq .8$  nm. This length scale corresponds to the prime  $p \simeq 2^{13}$  and would represent a very low information content unlike  $k = 142$ , which corresponds to rather large prime  $p \simeq 2^{71}$ . The ratio  $\lambda_{dB}/L(k)$  is same as in the first case.

#### 2. The energy is used to excite the entire water molecule

1. In the case of electronic Cooper pairs the condition  $r = 8$  gives  $k = 141 = 3 \times 47$  corresponding to the tertiary p-adic length scale  $L(3, 47) \simeq .4$  nm.
2. In the case of electrons one has  $k = 142 = 2 \times 71$ .  
In both cases the ratio  $\lambda_{dB}/L(k)$  grows by a factor  $\sqrt{2}$  from the value in the preceding case so that the resulting model is poorer.

As a summary one can state the following.

1. The ratio of the thermal de-Broglie wave length to the p-adic length scale is same for both electron and Cooper pair options since the p-adic length scales are  $L(k)$  for electron and  $L(k - 1)$  for the Cooper pair and differ by a factor of  $\sqrt{2}$  from each other.
2. For all options de Broglie wavelength in the case of ordinary electrolysis is at least by a factor of two too large and this forces to question the de Broglie wave length criterion. Of course, one can think that the production of positive energy photons generates temporary hot spots so that de Broglie conditions holds true after all.
3. The dropping of two electronic Cooper pairs per water molecule from  $k = 2 \times 71$  space-time sheet is the most promising option, since in this case the mechanism of induced emission is possible and a satisfactory consistency with de Broglie criterion is achieved. The secondary p-adic length scale is also very natural.

### Could phase transition to dark matter reduce the energy of OH bonds

An alternative explanation for the findings of Kanarev is that the *energy scale* of some OH bonds is reduced by some new physics mechanism. No excitation would thus be involved. Dark matter hierarchy [K26] provides a candidate for this kind of mechanism.

There is evidence for the occurrence of cold nuclear reactions in Kanarev's plasma electrolysis using KOH and NaOH in water environment [D29]. The TGD based model [L3], [L3] assuming

the presence of dark analogs of  $Li$  nuclei modelled as nuclear strings and also longer nuclei obtained by fusing  $Li$  nuclear strings can explain the presence of the observed nuclei in the  $Fe$  cathode as resulting in cold nuclear reactions. The model is consistent with the TGD based description of cold fusion observed in deuterium systems [L3] , [L3] , and provides also a possible solution to the so called lithium problem of cosmology [E13] and  $H_{1.5}O$  anomaly of water [D12, D11, D16, D24] .

$H_{1.5}O$  anomaly suggests that 1/4 of protons of water are dark in atto-second time scale [K23] and one can imagine that both protons of water molecule can become dark under conditions defined by plasma electrolysis. Also the atomic space-time sheets and electron associated with  $OH$  bonds could become dark. The model of cold fusion assumes that the nuclear space-time sheets of  $Li$  nuclei become dark in plasma electrolysis so that also their size is scaled up. The phase transition of  $Li$  to its dark variant (there would be some kinetic equilibrium) could explain why the abundance of  $Li$  predicted by standard Big Bang cosmology is by a factor of 2.5 higher than the measured abundance.

Atomic binding energies transform as  $1/\hbar^2$  and are scaled down. If the energy of hydrogen bond transforms like Coulombic interaction energy as given by the perturbative calculation, it is scaled down as  $1/\hbar$  since the length of the bond scales up like  $\hbar$ . Effectively  $\alpha_{em} \propto 1/\hbar$  is replaced by its scaled down value. For  $\hbar \rightarrow 2^4\hbar_0$  the energy would scale from 8 eV to .5 eV and the standard metabolic energy quantum could induce the splitting of the dark  $OH$  bond. If  $2^4$  is the scale factor of  $\hbar$  for dark nuclear space-time sheets, their size would be of order  $10^{-3}$  meters. A scaling up to the size of even atomic size is considered in [L3] , [L3] .

The fact that the energy of hydrogen bonds [D4] is typically around .5 eV forces to ask what distinguishes hydrogen bond from dark  $OH$  bond. Could it be that the two bonds are one and the same thing so that dark  $OH$  bonds would form standard part of the standard chemistry and molecular biology? In hydrogen bond same hydrogen would be shared by the oxygen atoms of the neighboring atoms. For the first  $O$  the bond would be ordinary  $OH$  bond and for the second  $O$  its dark variant with scaled down Coulomb energy. In plasma electrolysis both bonds would become dark. The variation of the hydrogen bond energy could reflect the variation of the scaling factor of  $\hbar$ . The concentration of the spectrum of bond energies on integer multiples of fundamental energy scale - or even better, on powers of 2 - would provide support for the identification. There is evidence for two kinds of hydrogen bonds with bond energies in ratio 1:2 [?, D32] : the TGD based model is discussed in [K23] . The energy needed to transform the bond to dark bond could come from remote metabolism from the dropping of dark protons from a dark variant of some sub-atomic space-time sheet with size not smaller than the size of the atomic space-time sheet to a larger space-time sheet.

### 3.5.3 The anomaly related to the thermal dissociation of molecular hydrogen

Already the Nobel-chemist Langmuir found, that thermal dissociation in a temperature range extending up to the temperature of  $T = 2200$  K, led to a much higher dissociation rate than one might expect on basis of thermodynamical considerations. The binding energy of the hydrogen molecule is 4.52 eV. If one requires that the ratio of the dissociated molecules to that of non-dissociated molecules is given as by the Boltzmann exponent  $exp(-E_b/kT)$ , a discrepancy of order  $10^8$  results. If one assumes that the effective binding energy is  $\simeq .44$  eV, a correct result is obtained.

This suggests that also now the dissociating hydrogen molecule receives energy from some source and that the energy is  $\sim 4$  eV. Dissociation mechanism could be based either on the self-excitation of the hydrogen molecule by the emission of negative energy photons. Also some other system could emit negative energy photons and induce a cascade of positive energy photons. One has two options.

1. The dropping of an electronic Cooper pair from  $k = 142 = 2 \times 71$  space-time sheet is involved as in the case of the optimal mechanism for the dissociation of water.
2. The dropping of an electron from  $k = 143$  space-time sheet is an alternative option.

### 3.5.4 Could q-Laguerre equation relate to the claimed fractionation of the principal quantum number for hydrogen atom?

The so called hydrino atom concept of Randell Mills [D23] represents one of the notions related to free energy research not taken seriously by the community of university physicists. What is claimed that hydrogen atom can exist as scaled down variants for which binding energies are much higher than usually due to the large Coulomb energy. The claim is that the quantum number  $n$  having integer values  $n = 0, 1, 2, 3, \dots$  and characterizing partially the energy levels of the hydrogen atom can have also inverse integer values  $n = 1/2, 1/3, \dots$ . The claim of Mills is that the laboratory BlackLight Inc. led by him can produce a plasma state in which transitions to these exotic bound states can occur and liberate as a by-product usable energy.

The National Aeronautic and Space Administration has dispatched mechanical engineering professor Anthony Marchese from Rowan University to BlackLight's labs in Cranbury, NJ, to investigate whether energy plasmas-hot, charged gases- produced by Mills might be harnessed for a new generation of rockets. Marchese reported back to his sponsor, the NASA Institute for Advanced Concepts, that indeed the plasma was so far unexplainably energetic. An article about the findings of Mills and collaborators have been accepted for publication in Journal of Applied Physics so that there are reasons to take seriously the experimental findings of Mills and collaborators even if one does not take seriously the theoretical explanations.

The fractionized principal quantum number  $n$  claimed by Mills [D23] is reported to have at least the values  $n = 1/k$ ,  $k = 2, 3, 4, 5, 6, 7, 10$ . First explanation would be in terms of Planck constant having also values smaller than  $\hbar_0$  possible if singular factor spaces of causal diamond CD and  $CP_2$  are allowed. q-Deformations of ordinary quantum mechanics are suggested strongly by the hierarchy of Jones inclusion associated with the hyper-finite factor of type  $II_1$  about which WCW spinors are a basic example. This motivates the attempt to understand the claimed fractionization in terms of q-analog of hydrogen atom. The safest interpretation for them would be as states which can exist in ordinary imbedding space (and also in other branches)

The Laguerre polynomials appearing in the solution of Schrödinger equation for hydrogen atom possess quantum variant, so called q-Laguerre polynomials [A9], and one might hope that they would allow to realize this semiclassical picture at the level of solutions of appropriately modified Schrödinger equation and perhaps also resolve the difficulty associated with  $n = 1/2$ . Unfortunately, the polynomials discussed in [A9] correspond to  $0 < q \leq 1$  rather than complex values of  $q = \exp(i\pi/m)$  on circle and the extrapolation of the formulas for energy eigenvalues gives complex energies.

#### q-Laguerre equation for $q = \exp(i\pi/m)$

The most obvious modification of the Laguerre equation for  $S$ -wave states (which are the most interesting by semiclassical argument) in the complex case is based on the replacement

$$\begin{aligned} \partial_x &\rightarrow \frac{1}{2}(\partial_x^q + \partial_x^{\bar{q}}) \\ \partial_x^q f &= \frac{f(qx) - f(x)}{(q-1)x} , \\ q &= \exp(i\pi/m) \end{aligned} \tag{3.5.5}$$

to guarantee hermiticity. When applied to the Laguerre equation

$$x \frac{d^2 L_n}{dx^2} + (1-x) \frac{dL_n}{dx} = nL_n , \tag{3.5.6}$$

and expanding  $L_n$  into Taylor series

$$L_n(x) = \sum_{n \geq 0} l_n x^n , \tag{3.5.7}$$

one obtains difference equation

$$\begin{aligned}
 a_{n+1}l_{n+1} + b_n l_n &= 0 , \\
 a_{n+1} &= \frac{1}{4R_1^2} [R_{2n+1} - R_{2n} + 2R_{n+1}R_1 + 3R_1] + \frac{1}{2R_1} [R_{n+1} + R_1] \\
 b_n &= \frac{R_n}{2R_1} - n^q + \frac{1}{2} , \\
 R_n &= 2\cos[(n-1)\pi/m] - 2\cos[n\pi/m] .
 \end{aligned} \tag{3.5.8}$$

Here  $n^q$  is the fractionized principal quantum number determining the energy of the q-hydrogen atom. One cannot pose the difference equation on  $l_0$  since this together with the absence of negative powers of  $x$  would imply the vanishing of the entire solution. This is natural since for first order difference equations lowest term in the series should be chosen freely.

### Polynomial solutions of q-Laquerre equation

The condition that the solution reduces to a polynomial reads as

$$b_n = 0 \tag{3.5.9}$$

and gives

$$n^q = \frac{1}{2} + \frac{R_n}{2R_1} , \tag{3.5.10}$$

For  $n = 1$  one has  $n^q = 1$  so that the ground state energy is not affected. At the limit  $N \rightarrow \infty$  one obtains  $n^q \rightarrow n$  so that spectrum reduces to that for hydrogen atom. The periodicity  $R_{n+2Nk} = R_n$  reflects the corresponding periodicity of the difference equation which suggests that only the values  $n \leq 2m - 1$  belong to the spectrum. Spectrum is actually symmetric with respect to the middle point  $[N/2]$  which suggests that only  $n < [m/2]$  corresponds to the physical spectrum. An analogous phenomenon occurs for representations of quantum groups [K9]. When  $m$  increases the spectrum approaches integer valued spectrum and one has  $n > 1$  so that no fractionization in the desired sense occurs for polynomial solutions.

### Non-polynomial solutions of q-Laquerre equation

One might hope that non-polynomial solutions associated with some fractional values of  $n^q$  near to those claimed by Mills might be possible. Since the coefficients  $a_n$  and  $b_n$  are periodic, one can express the solution ansatz as

$$\begin{aligned}
 L_n(x) &= P_a^{2m}(x) \sum_k a^k x^{2mk} = P_a^{2m}(x) \frac{1}{1 - ax^{2m}} , \\
 P_a^{2m}(x) &= \sum_{k=0}^{2m-1} l_k x^k , \\
 a &= \frac{l_{2m}}{l_0} ,
 \end{aligned} \tag{3.5.11}$$

This solution behaves as  $1/x$  asymptotically but has pole at  $x_\infty = (1/a)^{1/2m}$  for  $a > 0$ .

The expression for  $l_{2m}/l_0 = a$  is

$$a = \prod_{k=1}^{2m} \frac{b_{2m-k}}{a_{2m-k+1}} . \tag{3.5.12}$$

This can be written more explicitly as

$$\begin{aligned}
 a &= (2R_1)^{2m} \prod_{k=1}^{2m} X_k , \\
 X_k &= \frac{R_{2m-k} + (-2n^q) + 1)R_1}{R_{4m-2k+1} - R_{4m-2k} + 4R_{2m-k+1}R_1 + 2R_1^2 + 3R_1} , \\
 R_n &= 2\cos[(n-1)\pi/m] - 2\cos[n\pi/m] .
 \end{aligned}
 \tag{3.5.13}$$

This formula is a specialization of a more general formula for  $n = 2m$  and resulting ratios  $l_n/l_0$  can be used to construct  $P_a^{2m}$  with normalization  $P_a^{2m}(0) = 1$ .

**Results of numerical calculations**

Numerical calculations demonstrate following.

1. For odd values of  $m$  one has  $a < 0$  so that a a continuous spectrum of energies seems to result without any further conditions.
2. For even values of  $m$   $a$  has a positive sign so that a pole results.

For even value of  $m$  it could happen that the polynomial  $P_a^{2m}(x)$  has a compensating zero at  $x_\infty$  so that the solution would become square integrable. The condition for reads explicitly

$$P_a^{2m}\left(\left(\frac{1}{a}\right)^{\frac{1}{2m}}\right) = 0 .
 \tag{3.5.14}$$

If  $P_a^{2m}(x)$  has zeros there are hopes of finding energy eigen values satisfying the required conditions. Laguerre polynomials and also q-Laguerre polynomials must posses maximal number of real zeros by their orthogonality implied by the hermiticity of the difference equation defining them. This suggests that also  $P_a^{2m}(x)$  possesses them if  $a$  does not deviate too much from zero. Numerical calculations demonstrate that this is the case for  $n^q < 1$ .

For ordinary Laguerre polynomials the naive estimate for the position of the most distant zero in the units used is larger than  $n$  but not too much so. The naive expectation is that  $L_{2m}$  has largest zero somewhat above  $x = 2m$  and that same holds true a small deformation of  $L_{2m}$  considered now since the value of the parameter  $a$  is indeed very small for  $n^q < 1$ . The ratio  $x_\infty/2m$  is below .2 for  $m \leq 10$  so that this argument gives good hopes about zeros of desired kind.

One can check directly whether  $x_\infty$  is near to zero for the experimentally suggested candidates for  $n^q$ . The table below summarizes the results of numerical calculations.

1. The table gives the exact eigenvalues  $1/n_q$  with a 4-decimal accuracy and corresponding approximations  $1/n_{\approx}^q = k$  for  $k = 3, \dots, 10$ . For a given value of  $m$  only single eigenvalue  $n^q < 1$  exists. If the observed anomalous spectral lines correspond to single electron transitions, the values of  $m$  for them must be different. The value of  $m$  for which  $n^q \simeq 1/k$  approximation is optimal is given with boldface. The value of  $k$  increases as  $m$  increases. The lowest value of  $m$  allowing the desired kind of zero of  $P^{2m}$  is  $m = 18$  and for  $k \in \{3, 10\}$  the allowed values are in range 18, ..., 38.
2.  $n^q = 1/2$  does not appear as an approximate eigenvalue so that for even values of  $m$  quantum calculation produces same disappointing result as the classical argument. Below it will be however found that  $n^q = 1/2$  is a universal eigenvalue for odd values of  $m$ .

m	$1/n_{\approx}^q$	$1/n^q$	m	$1/n_{\approx}^q$	$1/n^q$
<b>18</b>	<b>3</b>	2.7568	30	8	7.5762
<b>20</b>	<b>4</b>	3.6748	<b>32</b>	<b>8</b>	8.3086
22	5	4.5103	<b>34</b>	<b>9</b>	9.0342
<b>24</b>	<b>5</b>	5.3062	<b>36</b>	<b>10</b>	9.7529
<b>26</b>	<b>6</b>	6.0781	38	10	10.4668
<b>28</b>	<b>7</b>	6.8330			



Table3. The table gives the approximations  $1/n^q)_{\simeq} = 1/k$  and corresponding exact values  $1/n^q$  in the range  $k = 3, \dots, 10$  for which  $P_a^{2m}(x_\infty)$  is nearest to zero. The corresponding values of  $m = 2k$  vary in the range,  $k = 18, \dots, 38$ . For odd values of  $m$  the value of the parameter  $a$  is negative so that there is no pole. Boldface marks for the best approximation by  $1/n^q)_{\simeq} = k$ .

### How to obtain $n^q) = 1/2$ state?

For odd values of  $m$  the quantization recipe fails and physical intuition tells that there must be some manner to carry out quantization also now. The following observations give a hunch about the desired condition.

1. For the representations of quantum groups only the first  $m$  spins are realized [K9] . This suggests that there should exist a symmetry relating the coefficients  $l_n$  and  $l_{n+m}$  and implying  $n^q) = 1/2$  for odd values of  $m$ . This symmetry would remove also the double degeneracy associated with the almost integer eigenvalues of  $n^q)$ . Also other fractional states are expected on basis of physical intuition.
2. For  $n^q) = 1/2$  the recursion formula for the coefficients  $l_n$  involves only the coefficients  $R_m$ .
3. The coefficients  $R_k$  have symmetries  $R_k = R_{k+2m}$  and  $R_{k+m} = -R_m$ .

There is indeed this kind of symmetry. From the formula

$$\begin{aligned} \frac{l_n}{l_0} &= (2R_1)^n \prod_{k=1}^n X_k , \\ X_k &= \frac{R_{n-k} + (-2n^q) + 1)R_1}{[R_{2n-2k+1} - R_{n-2k} + 4R_{n-k+1}R_1 + 2R_1^2 + 3R_1]} \end{aligned} \quad (3.5.15)$$

one finds that for  $n^q) = 1/2$  the formula giving  $l_{n+m}$  in terms of  $l_n$  changes sign when  $n$  increases by one unit

$$\begin{aligned} A_{n+1} &= (-1)^m A_n , \\ A_n &= \prod_{k=1}^m \frac{b_{n+m-k}}{a_{n+m-k+1}} = \prod_{k=1}^m (2R_1)^m \prod_{k=1}^m X_{k+n} . \end{aligned} \quad (3.5.16)$$

The change of sign is essentially due to the symmetries  $a_{n+m} = -a_n$  and  $b_{n+m} = b_n$ . This means that the action of translations on  $A_n$  in the space of indices  $n$  are represented by group  $Z_2$ .

This symmetry implies  $a = l_{2m}/l_0 = -(l_m)(l_0)^2$  so that for  $n^q) = 1/2$  the polynomial in question has a special form

$$\begin{aligned} P_a^{2m)} &= P_a^m(1 - Ax^m) , \\ A &= A_0 . \end{aligned} \quad (3.5.17)$$

The relationship  $a = -A^2$  implies that the solution reduces to a form containing the product of  $m^{\text{th}}$  (rather than  $(2m)^{\text{th}}$ ) order polynomial with a geometric series in  $x^m$  (rather than  $x^{2m}$ ):

$$L_{1/2}(x) = \frac{P_a^m(x)}{1 + Ax^m} . \quad (3.5.18)$$

Hence the  $n$  first terms indeed determine the solution completely. For even values of  $m$  one obtains similar result for  $n^q) = 1/2$  but now  $A$  is negative so that the solution is excluded. This result also motivates the hypothesis that for the counterparts of ordinary solutions of Laguerre equation

sum (even  $m$ ) or difference (odd  $m$ ) of solutions corresponding to  $n$  and  $2m - n$  must be formed to remove the non-physical degeneracy.

This argument does not exclude the possibility that there are also other fractional values of  $n$  allowing this kind of symmetry. The condition for symmetry would read as

$$\begin{aligned} \prod_{k=1}^m (R_k + \epsilon R_1) &= \prod_{k=1}^m (R_k - \epsilon R_1) , \\ \epsilon &= (2n^q) - 1 . \end{aligned} \quad (3.5.19)$$

The condition states that the odd part of the polynomial in question vanishes. Both  $\epsilon$  and  $-\epsilon$  solutions so that  $n^q$  and  $1 - n^q$  are solutions. If one requires that the condition holds true for all values of  $m$  then the comparison of constant terms in these polynomials allows to conclude that  $\epsilon = 0$  is the only universal solution. Since  $\epsilon$  is free parameter, it is clear that the  $m$ :th order polynomial in question has at most  $m$  solutions which could correspond to other fractionized eigenvalues expected to be present on basis of physical intuition.

This picture generalizes also to the case of even  $n$  so that also now solutions of the form of Eq. 7.4.14 are possible. In this case the condition is

$$\prod_{k=1}^m (R_k + \epsilon R_1) = - \prod_{k=1}^m (R_k - \epsilon R_1) . \quad (3.5.20)$$

Obviously  $\epsilon = 0$  and thus  $n = 1/2$  fails to be a solution to the eigenvalue equation in this case. Also now one has the spectral symmetry  $n_{\pm} = 1/2 \pm \epsilon$ .

The symmetry  $R_n = (-1)^m R_{n+m-1} = (-1)^m R_{n-m-1} = (-1)^m R_{m-n+1}$  can be applied to show that the polynomials associated with  $\epsilon$  and  $-\epsilon$  contain both the terms  $R_n - \epsilon$  and  $R_n + \epsilon$  as factors except for odd  $m$  for  $n = (m + 1)/2$ . Hence the values of  $n$  can be written for even values of  $m$  as

$$n^q(n) = \frac{1}{2} \pm \frac{R_n}{2R_1} , \quad n = 1, \dots, \frac{m}{2} , \quad (3.5.21)$$

and for odd values of  $m$  as

$$\begin{aligned} n_{\pm}^q(n) &= \frac{1}{2} \pm \frac{R_n}{2R_1} , \quad n = 1, \dots, \frac{m+1}{2} - 1 , \\ n^q &= 1/2 . \end{aligned} \quad (3.5.22)$$

Plus sign obviously corresponds to the solutions which reduce to polynomials and to  $n^q \simeq n$  for large  $m$ . The explicit expression for  $n^q$  reads as

$$n_{\pm}^q(n) = \frac{1}{2} \pm \frac{(\sin^2(\pi(n-1)/2m) - \sin^2(\pi n/2m))}{2\sin^2(\pi/2m)} . \quad (3.5.23)$$

At the limit of large  $m$  one has

$$n_{+}^q(n) \simeq n , \quad n_{-}^q(n) \simeq 1 - n . \quad (3.5.24)$$

so that the fractionization  $n \simeq 1/k$  claimed by Mills is not obtained at this limit. The minimum for  $|n^q|$  satisfies  $|n^q| < 1$  and its smallest value  $|n^q| = .7071$  corresponds to  $m = 4$ . Thus these zeros cannot correspond to  $n^q \simeq 1/k$  yielded by the numerical computation for even values of  $m$  based on the requirement that the zero of  $P^{2m}$  cancels the pole of the geometric series.

### Some comments

Some closing comments are in order.

1. An open question is whether there are also zeros  $|n^q| > 1$  satisfying  $P_a^{2m}((1/a)^{1/2m}) = 0$  for even values of  $m$ .
2. The treatment above is not completely general since only s-waves are discussed. The generalization is however a rather trivial replacement  $(1-x)d/dx \rightarrow (l+1-x)d/dx$  in the Laguerre equation to get associated Laguerre equation. This modifies only the formula for  $a_{n+1}$  in the recursion for  $l_n$  so that expression for  $n^q$ , which depends on  $b_n$ :s only, is not affected. Also the product of numerators in the formula for the parameter  $a = l_{2m}/l_0$  remains invariant so that the general spectrum has the spectral symmetry  $n^q \rightarrow 1 - n^q$ . The only change to the spectrum occurs for even values of  $m$  and is due to the dependence of  $x_\infty = (1/a)^{1/2m}$  on  $l$  and can be understood in the semiclassical picture. It might happen that the value of  $l$  is modified to its  $q$  counterpart corresponding to q-Legendre functions.
3. The model could partially explain the findings of Mills and  $n^q \simeq 1/k$  for  $k > 2$  also fixes the value of corresponding  $m$  to a very high degree so that one would have direct experimental contact with generalized imbedding space, spectrum of Planck constants, and dark matter. The fact that the fractionization is only approximately correct suggests that the states in question could be possible for all sectors of imbedding space appear as intermediate states into sectors in which the spectrum of hydrogen atom is scaled by  $n_b/n_a = k = 2, 3, \dots$
4. The obvious question is whether q-counterparts of angular momentum eigenstates ( $idf_m/d\phi = mf_m$ ) are needed and whether they make sense. The basic idea of construction is that the phase transition changing  $\hbar$  does not involve any other modifications except fractionization of angular momentum eigenvalues and momentum eigenvalues having purely geometric origin. One can however ask whether it is possible to identify q-plane waves as ordinary plane waves. Using the definition  $L_z = 1/2(\partial_u^q + \partial_{\bar{u}}^q)$ ,  $u = \exp(i\phi)$ , one obtains  $f_n = \exp(in\phi)$  and eigenvalues as  $n^q = R_n/R_1 \rightarrow n$  for  $m \rightarrow \infty$ . Similar construction applies in the case of momentum components.

### 3.5.5 Free energy from atomic hydrogen

The anomalies reported by free energy researchers such as over unity energy production in devices involving repeated formation and dissociation of  $H_2$  molecules based on the original discovery of Nobelist Irwing Langmuir [D30] (see for instance [H39] ) suggest that part of  $H$  atoms might end up to dark matter phase liberating energy.

An especially interesting device tested and described in detail by Naudin [H39] is MAHG (Möller's Atomic Hydrogen Generator). The system behaves as an over-unity device producing energy from atomic hydrogen by a repeated dissociation and recombination of hydrogen atoms. MAHG tube contains a vacuum tube filled with hydrogen at 0.1 atm and cooled by water. The main part of the MAHG is a tungsten filament (0.25 mm diameter) placed in the center. Dissociation requires a heating of the tungsten filament to a temperature of about 2000 K.

A possible explanation of over-unity effect is inspired by the model of water as a partially dark matter in which one fourth of hydrogen atoms are in a dark phase forming linear super-nuclei with the distance between protons connected by color bonds being few Angstroms [K23] . The over-unity energy production could be due to a gradual transformation of hydrogen to dark hydrogen in the same state as in water. This transformation would compete with recombination and be responsible for the over unity energy production even if the liberated energy is smaller than in recombination since the resulting dark hydrogen would not dissociate anymore. The process could not continue indefinitely since the amount of ordinary hydrogen would be gradually reduced.

Also the dropping of some hydrogen atoms to larger space-time sheets accompanied by liberation of zero point kinetic energy of order .5 eV could be involved and have similar implications since the heating (thermal energy is about .2 eV) is not quite enough to kick all dropped protons back to the atomic space-time sheets.

## 3.6 Appendix: A generalization of the notion of imbedding space inspired by hierarchy of Planck constants

The hypothesis that Planck constant is quantized having in principle all possible rational values but with some preferred values implying algebraically simple quantum phases has been one of the main ideas of TGD during last years. The mathematical realization of this idea leads to a profound generalization of the notion of imbedding space obtained by gluing together infinite number of copies of imbedding space along common 4-dimensional intersection. The hope was that this generalization could explain charge fractionization but this does not seem to be the case. This problem led to a further generalization of the imbedding space and this is what I want to discussed below.

### 3.6.1 The original view about generalized imbedding space

The original generalization of imbedding space was basically following. Take imbedding space  $H = M^4 \times CP_2$ . Choose sub-manifold  $M^2 \times S^2$ , where  $S^2$  is homologically non-trivial geodesic sub-manifold of  $CP_2$ . The motivation is that for a given choice of Cartan algebra of Poincare algebra (translations in time direction and spin quantization axis plus rotations in plane orthogonal to this plane plus color hypercharge and isospin) this sub-manifold remains invariant under the transformations leaving the quantization axes invariant.

Form spaces  $\hat{M}^4 = M^4 \setminus M^2$  and  $\hat{CP}_2 = CP_2 \setminus S^2$  and their Cartesian product. Both spaces have a hole of co-dimension 2 so that the first homotopy group is  $Z$ . From these spaces one can construct an infinite hierarchy of factor spaces  $\hat{M}^4/G_a$  and  $\hat{CP}_2/G_b$ , where  $G_a$  is a discrete group of  $SU(2)$  leaving quantization axis invariant. In case of Minkowski factor this means that the group in question acts essentially as a combination reflection and to rotations around quantization axes of angular momentum. The generalized imbedding space is obtained by gluing all these spaces together along  $M^2 \times S^2$ .

The hypothesis is that Planck constant is given by the ratio  $\hbar/hbar_0 = (n_a/n_b)$ , where  $n_i$  is the order of maximal cyclic subgroups of  $G_i$ . The hypothesis states also that the covariant metric of the Minkowski factor is scaled by the factor  $(n_a/n_b)^2$ . One must take care of this in the gluing procedure. One can assign to the field bodies describing both self interactions and interactions between physical systems definite sector of generalized imbedding space characterized partially by the Planck constant. The phase transitions changing Planck constant correspond to tunnelling between different sectors of the imbedding space.

### 3.6.2 Fractionization of quantum numbers is not possible if only factor spaces are allowed

The original idea was that the proposed modification of the imbedding space could explain naturally phenomena like quantum Hall effect involving fractionization of quantum numbers like spin and charge. This does not however seem to be the case.  $G_a \times G_b$  implies just the opposite if these quantum numbers are assigned with the symmetries of the imbedding space. For instance, quantization unit for orbital angular momentum becomes  $n_a$  where  $Z_{n_a}$  is the maximal cyclic subgroup of  $G_a$ .

One can however imagine of obtaining fractionization at the level of imbedding space for space-time sheets, which are analogous to multi-sheeted Riemann surfaces (say Riemann surfaces associated with  $z^{1/n}$  since the rotation by  $2\pi$  understood as a homotopy of  $M^4$  lifted to the space-time sheet is a non-closed curve. Continuity requirement indeed allows fractionization of the orbital quantum numbers and color in this kind of situation.

### 3.6.3 Both covering spaces and factor spaces are possible

The observation above stimulates the question whether it might be possible in some sense to replace  $H$  or its factors by their multiple coverings.

1. This is certainly not possible for  $M^4$ ,  $CP_2$ , or  $H$  since their fundamental groups are trivial. On the other hand, the fixing of quantization axes implies a selection of the sub-space  $H_4 =$

$M^2 \times S^2 \subset M^4 \times CP_2$ , where  $S^2$  is a geodesic sphere of  $CP_2$ .  $\hat{M}^4 = M^4 \setminus M^2$  and  $\hat{CP}_2 = CP_2 \setminus S^2$  have fundamental group  $Z$  since the codimension of the excluded sub-manifold is equal to two and homotopically the situation is like that for a punctured plane. The exclusion of these sub-manifolds defined by the choice of quantization axes could naturally give rise to the desired situation.

2.  $H_4$  represents a straight cosmic string. Quantum field theory phase corresponds to Jones inclusions with Jones index  $\mathcal{M} : \mathcal{N} < 4$ . Stringy phase would by previous arguments correspond to  $\mathcal{M} : \mathcal{N} = 4$ . Also these Jones inclusions are labelled by finite subgroups of  $SO(3)$  and thus by  $Z_n$  identified as a maximal Abelian subgroup.

One can argue that cosmic strings are not allowed in QFT phase. This would encourage the replacement  $\hat{M}^4 \times \hat{CP}_2$  implying that surfaces in  $M^4 \times S^2$  and  $M^2 \times CP_2$  are not allowed. In particular, cosmic strings and  $CP_2$  type extremals with  $M^4$  projection in  $M^2$  and thus light-like geodesic without zitterbewegung essential for massivation are forbidden. This brings in mind instability of Higgs=0 phase.

3. The covering spaces in question would correspond to the Cartesian products  $\hat{M}^4_{n_a} \times \hat{CP}_{2n_b}$  of the covering spaces of  $\hat{M}^4$  and  $\hat{CP}_2$  by  $Z_{n_a}$  and  $Z_{n_b}$  with fundamental group is  $Z_{n_a} \times Z_{n_b}$ . One can also consider extension by replacing  $M^2$  and  $S^2$  with its orbit under  $G_a$  (say tetrahedral, octahedral, or icosahedral group). The resulting space will be denoted by  $\hat{M}^4 \hat{\times} G_a$  resp.  $\hat{CP}_2 \hat{\times} G_b$ .
4. One expects the discrete subgroups of  $SU(2)$  emerge naturally in this framework if one allows the action of these groups on the singular sub-manifolds  $M^2$  or  $S^2$ . This would replace the singular manifold with a set of its rotated copies in the case that the subgroups have genuinely 3-dimensional action (the subgroups which corresponds to exceptional groups in the ADE correspondence). For instance, in the case of  $M^2$  the quantization axes for angular momentum would be replaced by the set of quantization axes going through the vertices of tetrahedron, octahedron, or icosahedron. This would bring non-commutative homotopy groups into the picture in a natural manner.

Also the orbifolds  $\hat{M}^4/G_a \times \hat{CP}_2/G_b$  can be allowed as also the spaces  $\hat{M}^4/G_a \times (\hat{CP}_2 \hat{\times} G_b)$  and  $(\hat{M}^4 \hat{\times} G_a) \times \hat{CP}_2/G_b$ . Hence the previous framework would generalize considerably by the allowance of both coset spaces and covering spaces.

### 3.6.4 Do factor spaces and coverings correspond to the two kinds of Jones inclusions?

What could be the interpretation of these two kinds of spaces?

1. Jones inclusions appear in two varieties corresponding to  $\mathcal{M} : \mathcal{N} < 4$  and  $\mathcal{M} : \mathcal{N} = 4$  and one can assign a hierarchy of subgroups of  $SU(2)$  with both of them. In particular, their maximal Abelian subgroups  $Z_n$  label these inclusions. The interpretation of  $Z_n$  as invariance group is natural for  $\mathcal{M} : \mathcal{N} < 4$  and it naturally corresponds to the coset spaces. For  $\mathcal{M} : \mathcal{N} = 4$  the interpretation of  $Z_n$  has remained open. Obviously the interpretation of  $Z_n$  as the homology group defining covering would be natural.
2.  $\mathcal{M} : \mathcal{N} = 4$  should correspond to the allowance of cosmic strings and other analogous objects. Does the introduction of the covering spaces bring in cosmic strings in some controlled manner? Formally the subgroup of  $SU(2)$  defining the inclusion is  $SU(2)$  would mean that states are  $SU(2)$  singlets which is something non-physical. For covering spaces one would however obtain the degrees of freedom associated with the discrete fiber and the degrees of freedom in question would not disappear completely and would be characterized by the discrete subgroup of  $SU(2)$ .

For anyons the non-trivial homotopy of plane brings in non-trivial connection with a flat curvature and the non-trivial dynamics of topological QFTs. Also now one might expect similar non-trivial contribution to appear in the spinor connection of  $\hat{M}^2 \hat{\times} G_a$  and  $\hat{CP}_2 \hat{\times} G_b$ . In conformal field theory models non-trivial monodromy would correspond to the presence of punctures in plane.

3. For factor spaces the unit for quantum numbers like orbital angular momentum is multiplied by  $n_a$  resp.  $n_b$  and for coverings it is divided by this number. These two kind of spaces are in a well defined sense obtained by multiplying and dividing the factors of  $\hat{H}$  by  $G_a$  resp.  $G_b$  and multiplication and division are expected to relate to Jones inclusions with  $\mathcal{M} : \mathcal{N} < 4$  and  $\mathcal{M} : \mathcal{N} = 4$ , which both are labelled by a subset of discrete subgroups of  $SU(2)$ .
4. The discrete subgroups of  $SU(2)$  with fixed quantization axes possess a well defined multiplication with product defined as the group generated by forming all possible products of group elements as elements of  $SU(2)$ . This product is commutative and all elements are idempotent and thus analogous to projectors. Trivial group  $G_1$ , two-element group  $G_2$  consisting of reflection and identity, the cyclic groups  $Z_p$ ,  $p$  prime, and tetrahedral, octahedral, and icosahedral groups are the generators of this algebra.

By commutativity one can regard this algebra as an 11-dimensional module having natural numbers as coefficients ("rig"). The trivial group  $G_1$ , two-element group  $G_2$  generated by reflection, and tetrahedral, octahedral, and icosahedral groups define 5 generating elements for this algebra. The products of groups other than trivial group define 10 units for this algebra so that there are 11 units altogether. The groups  $Z_p$  generate a structure analogous to natural numbers acting as analog of coefficients of this structure. Clearly, one has effectively 11-dimensional commutative algebra in 1-1 correspondence with the 11-dimensional "half-lattice"  $N^{11}$  ( $N$  denotes natural numbers). Leaving away reflections, one obtains  $N^7$ . The projector representation suggests a connection with Jones inclusions. An interesting question concerns the possible Jones inclusions assignable to the subgroups containing infinitely manner elements. Reader has of course already asked whether dimensions 11, 7 and their difference 4 might relate somehow to the mathematical structures of M-theory with 7 compactified dimensions.

5. How do the Planck constants associated with factors and coverings relate? One might argue that Planck constant defines a homomorphism respecting the multiplication and division (when possible) by  $G_i$ . If so, then Planck constant in units of  $\hbar_0$  would be equal to  $n_a/n_b$  for  $\hat{H}/G_a \times G_b$  option and  $n_b/n_a$  for  $\hat{H} \hat{imes}(G_a \times G_b)$  with obvious formulas for hybrid cases. This option would put  $M^4$  and  $CP_2$  in a very symmetric role and allow much more flexibility in the identification of symmetries associated with large Planck constant phases.

### 3.6.5 Fractional Quantum Hall effect

The generalization of the imbedding space allows to understand fractional quantum Hall effect [D3] . The formula for the quantized Hall conductance is given by

$$\begin{aligned} \sigma &= \nu \times \frac{e^2}{h} , \\ \nu &= \frac{n}{m} . \end{aligned} \tag{3.6.1}$$

Series of fractions in  $\nu = 1/3, 2/5, 3/7, 4/9, 5/11, 6/13, 7/15, \dots, 2/3, 3/5, 4/7, 5/9, 6/11, 7/13, \dots, 5/3, 8/5, 11/7, 14/9, \dots, 1/5, 2/9, 3/13, \dots, 2/7, 3/11, \dots, 1/7, \dots$  with odd denominator have been observed as are also  $\nu = 1/2$  and  $\nu = 5/2$  states with even denominator [D3] .

The model of Laughlin [D33, D31] cannot explain all aspects of FQHE. The best existing model proposed originally by Jain is based on composite fermions resulting as bound states of electron and even number of magnetic flux quanta [D27] . Electrons remain integer charged but due to the effective magnetic field electrons appear to have fractional charges. Composite fermion picture predicts all the observed fractions and also their relative intensities and the order in which they appear as the quality of sample improves.

In [K84] I have proposed a possible TGD based model of FQHE not involving hierarchy of Planck constants. The generalization of the notion of imbedding space suggests also the possibility to interpret these states in terms of fractionized charge and electron number.

1. The easiest manner to understand the observed fractions is by assuming that both  $M^4$  and  $CP_2$  correspond to covering spaces so that both spin and electric charge and fermion

number are quantized. With this assumption the expression for the Planck constant becomes  $\hbar/\hbar_0 = n_b/n_a$  and charge and spin units are equal to  $1/n_b$  and  $1/n_a$  respectively. This gives  $\nu = nn_a/n_b^2$ . The values  $m = 2, 3, 5, 7, \dots$  are observed. Planck constant can have arbitrarily large values. There are general arguments stating that also spin is fractionized in FQHE and for  $n_a = kn_b$  required by the observed values of  $\nu$  charge fractionization occurs in units of  $k/n_b$  and forces also spin fractionization. For factor space option in  $M^4$  degrees of freedom one would have  $\nu = n/n_a n_b^2$ .

2. The appearance of  $n_b = 2$  would suggest that also  $Z_2$  appears as the homotopy group of the covering space: filling fraction  $1/2$  corresponds in the composite fermion model and also experimentally to the limit of zero magnetic field [D27]. Also  $\nu = 5/2$  has been observed [D22].
3. A possible problematic aspect of the TGD based model is the experimental absence of even values of  $n_b$  except  $n_b = 2$ . A possible explanation is that by some symmetry condition possibly related to fermionic statistics  $kn/n_b$  must reduce to a rational with an odd denominator for  $n_b > 2$ . In other words, one has  $k \propto 2^r$ , where  $2^r$  the largest power of 2 divisor of  $n_b$  smaller than  $n_b$ .
4. Large values of  $n_b$  emerge as  $B$  increases. This can be understood from flux quantization. One has  $eBS = n\hbar = n(n_b/n_a)\hbar_0$ . The interpretation is that each of the  $n_b$  sheets contributes  $n/n_a$  units to the flux. As  $B$  increases also the flux increases for a fixed value of  $n_a$  and area  $S$ . Note that the value of magnetic field in given sheet is not affected so that the build-up of multiple covering seems to keep magnetic field strength below critical value. For  $n_a = kn_b$  one obtains  $eBS/\hbar_0 = n/k$  so that a fractionization of magnetic flux results and each sheet contributes  $1/kn_b$  units to the flux.  $\nu = 1/2$  corresponds to  $k = 1, n_b = 2$  and to non-vanishing magnetic flux unlike in the case of composite fermion model.
5. The understanding of the thermal stability is not trivial. The original FQHE was observed in 80 mK temperature corresponding roughly to a thermal energy of  $T \sim 10^{-5}$  eV. For graphene the effect is observed at room temperature. Cyclotron energy for electron is (from  $f_e = 6 \times 10^5$  Hz at  $B = .2$  Gauss) of order thermal energy at room temperature in a magnetic field varying in the range 1-10 Tesla. This raises the question why the original FQHE requires so low temperature. The magnetic energy of a flux tube of length  $L$  is by flux quantization roughly  $e^2 B^2 S \sim E_c(e)m_e L$  ( $\hbar_0 = c = 1$ ) and exceeds cyclotron roughly by a factor  $L/L_e$ ,  $L_e$  electron Compton length so that thermal stability of magnetic flux quanta is not the explanation. A possible explanation is that since FQHE involves several values of Planck constant, it is quantum critical phenomenon and is characterized by a critical temperature. The differences of the energies associated with the phase with ordinary Planck constant and phases with different Planck constant would characterize the transition temperature.

## Chapter 4

# About Strange Effects Related to Rotating Magnetic Systems

### 4.1 Introduction

The basic hypothesis of Topological Geometrostatics (TGD) is that space-time is representable as a 4-surface in 8-dimensional space  $M^4 \times CP_2$ . The notion of many-sheeted space-time forced by this hypothesis implies numerous new physics effects.

The first prediction is the possibility of gravitational anomalies. For instance, the space-time sheet of system can feed the gravitational flux to several larger space-time sheets and when the distribution of the fluxes is non-standard, anomalous gravitational behavior results. Note that the change of gravitational mass alone without a change in the distribution of gravitational flux between different space-time sheets does not imply effects as long as the idealization as a test particle makes sense. The most recent view about coupling constant evolution [K2] however strongly suggests that gravitons correspond to the largest non-super-astrophysical Mersenne prime  $M_{127} = 2^{127} - 1$  assignable also to electron. Therefore gravitational interactions would be mediated along these space-time sheets and the space-time sheets carrying gravitational fields would be universal and this kind of anomalies would not be possible.

TGD predicts also the possibility of negative energy space-time sheets having non-standard time orientation. The implications are numerous. Negative energy topological light rays are expected to be accompanied by negative energy photons identifiable as phase conjugate photons. The generalization of four-wave mechanism involving generalization of standing waves emerges and provides a mechanism of remote metabolism in which system sucks energy from environment by sending negative energy particles such as phase conjugate photons. The geometric time reversal of second law is a signature of the process and the decay of system looks like self-assembly from the point of view of observer with standard arrow of geometric time. Generalized four-wave mechanism provides also a model over unity energy production and classical communications to the geometric past. In TGD inspired theory of consciousness and bio-matter this mechanism is central and underlies the models of metabolism, intentional action, and long term memory.

The phase conjugate hypothesis generalizes to the case of fermions and leads to the hypothesis that fermions and anti-fermions have opposite sign of energy. This guarantees that fermionic vacuum energy which otherwise diverges is vanishing. This inspires the hypothesis that the total quantum numbers of the Universe vanish. The assumption is consistent with the crossing symmetry of elementary particle physics and makes sense macroscopically if gravitational energy is identified as the difference of inertial energies of positive and negative energy matter. Vacuum extremals can be interpreted as space-time surfaces with vanishing inertial energy but non-vanishing gravitational energy density given by Einstein's equations. The resulting cosmology is maximally predictive. Note that the generation of vacuum extremals in general increases the gravitational mass of the system and this effect could be taken as a signature of the effect. The instability of the vacuum extremals against generation of inertial mass by sending either positive or negative inertial energy to environment implies a change of inertial mass of associated system which could also serve as a signature of the effect.



The geometrization of the classical gauge fields in turn predicts the existence of long range color and electro-weak gauge fields, in particular classical  $Z^0$  field, which gives rise to macroscopic effects resembling those assigned usually with torsion fields. These fields are assignable to dark matter hierarchy rather than ordinary matter.

The prediction that the Planck constants associated with  $M^4$  and  $CP_2$  degrees freedom are quantized as integer multiples of the ordinary Planck constant in "anyonic" phases is a further prediction [K26]. The interpretation of dark matter as a hierarchy of macroscopic quantum phases of this kind is highly attractive.

In this chapter various anomalies claimed by free energy researchers are discussed in this conceptual framework.

### 4.1.1 Anomalies associated with rotating magnetic systems

In the beginning of the year 2002 I learned about strange effects related to rotating magnetic systems, and the model for these effects has evolved (and is still evolving) gradually during the year 2002 via trial and error process. Several new physics effects seem to be involved.

#### Loss of effective weight

If the rotating magnetic system involves dark matter component as suggested by the considerations of [K71] and [K23], develops em and  $Z^0$  charges and experiences the classical em and  $Z^0$  electric forces created by Earth so that the effective weight is reduced or increases (depending on the direction of rotation) as much as 35 per cent. The charging is due to the flow of electrons and possibly also exotic neutrinos from the rolling magnets to the surrounding air induced by the radial electric and  $Z^0$  electric fields generated by the Faraday effect inducing vacuum charge density (not possible in Maxwell's electrodynamics). The fact that critical frequencies are different for clockwise and counter clockwise spontaneous rotation implies that classical  $Z^0$  force and dark (possibly neutrino) currents must be present.

#### Spontaneous accelerating rotation

The first guess is that only the magnetic fields of rollers rotate and the spontaneous accelerating rotation above critical frequency could be understood as being due to a Lorentz torque acting on the radial Ohmic em and  $Z^0$  currents in rollers and roller ring. This of course requires that this angular momentum is somehow transferred to the angular momentum of rollers.

Later it became clear that Lorentz torque might be only a control tool forcing electrons in rotating motion. If also the magnetic field of the stator rotate as one might expect if its return flux flows through the rollers, also the stator would contain a radial current and a flow equilibrium in which radial current flows from the stator to rollers could establish itself. It would induce opposite charges to the stator and rollers. Since electron charge distributions rotate and are not expected to possess a full rotational symmetry, an electrostatic torque is generated and vanishes if rollers rotate with the same velocity as electrons in the stator. This situation is still completely classical and requires an external force to compensate for the dissipative losses.

Above the critical frequency the torque, which is proportional to rotation frequency, becomes larger than frictional torque, and spontaneous accelerating rotation becomes possible due to the positive feedback.

The radial ohmic current of electrons leaking from the atomic space-time sheets of rollers to the space-time sheet of environment could explain the presence of plasma around the system. This is not the only mechanism that one can imagine: also the phase transition increasing p-adic prime of the space-time sheet could liberate energy. The phase transitions liberating cyclogtron energy could be also considered. Also the spontaneous magnetization of the magnetic body with large value of  $h_{eff}$  could liberate the magnetic binding energy. The ionization of the molecules is caused by the electrons from rollers gaining keV energy as they drop from atomic space-time sheets of rollers to the space-time sheets of the environment. Energetic constraints imply negative feedback and the modelling of this "back reaction" leads to a model of the system based on butterfly catastrophe in Thom's classification of elementary catastrophes and allowing also to understand

the effect of the load. Rather precise estimates for the parameters result and allow to quantify the role of classical  $Z^0$  force.

The mechanism transforming the torque on conduction electrons of the radial ohmic current to the torque on roller and providing the kinetic energy for the roller relies on the absorption of the photon emitted in this process by a lattice atom which is Ti atom in the experiments of Searl. The energetics comes out correctly.

### The material composition of the Searl device

Searl device has rather complex layered structure consisting of cylindrical layers of neodymium, nylon, iron, and titanium. This structure was not taken into account in the earlier model. A breakthrough in the understanding of this aspect came through the experimentation of Samuli Penttinen with simpler systems giving negative results and from his proposal that the non-magnetic nylon layer could serve as a charge reservoir or play some other important function.

This led to a construction of a detailed model for the current flow equilibrium for the 4-layered cylindrical structure with this material structure and to the study of the boundary conditions at the layer-layer boundaries. A rather detailed quantitative picture about how charge accumulates in the interiors of layers and to the layer-layer boundaries emerges. Perhaps the most important realization was that the small electrical conductivity of air requires in the flow equilibrium that the electric field at the outer boundary of titanium layer is amplified by a factor of order  $10^8$  to a field which is by a factor of order  $10^3$  higher than the critical field inducing dielectric breakdown in air so that the simple model fails. The huge increase of the electric field requires an accumulation of positive charge at Ti-air boundary and explains why the air must be ionized but not its mechanism based on the dropping of electrons to larger space-time sheets.

The question whether also the magnetic field associated with the stator rotates is raised by the observation that the flux of the stator magnetic field returns back along the rollers. If this magnetic field does not rotate the magnetic flux tubes get twisted as in the case of the solar magnetic field and the analog of the solar sunspot cycle should result. If the magnetic field of the stator rotates this does not happen. Also stator becomes an active component of the system and one can motivate its 4-layered structure.

The Lorentz force on the radial ohmic current forces the distribution of the conduction electrons to rotate. In the small air gap between stator and roller the radial electronic current from the stator can flow to the roller. This flow provides stator and rollers with opposite charges and generates electrostatic force between them and also breaks the full rotational symmetry of the rotating charge distributions in stator and rollers. Hence one expects that in the dynamical equilibrium rollers rotate with the same velocity as stator charge distribution and that the net electrostatic torque vanishes. This classical picture explains the classical behavior of the system but not the spontaneous acceleration of the rollers. Especially interesting phenomena are expected to occur in the air gap between stator and roller.

### Energetics behind the formation of the magnetic walls

Also the energetics behind the formation of magnetic walls should be understood. The magnetic walls could carry also Bose-Einstein condensates of Cooper pairs of dark electrons with electrons in collective cyclotron state with a net angular momentum. A remote metabolism based on the emission of negative energy (phase conjugate) dark microwave photons absorbed by the dropping electrons is the simplest that one can imagine. The large value of Planck constant would make the energies of microwave photons equal to the liberated zero point kinetic energy. This conforms with the cooling of the air around the system. Also a mechanism of remote spontaneous magnetization based based realized in terms of the generalized four-wave mechanism based on magnetostatic waves can be considered and would lead the formation of magnetic walls as a remote spontaneous magnetization of  $J = 2$  electron Cooper pairs at the space-time sheets of magnetic walls.

### Why the replication of the experiments is so difficult and how to optimize the Searl device?

The formation of the magnetic walls means the emergence of long length scale fluctuations with coherence length much longer than the size of the system. Hence a quantum critical phenomenon

seems to be in question and this could explain why the replication of the experimental findings has turned out to be so difficult. There are indeed many conditions to be satisfied. The distance between magnetic walls must correspond to the radius of the stator in resonance. This length scale also corresponds to the wavelength of dark microwave photons emitted in cyclotron transitions and the energy of these photons must also correspond to a zero point kinetic energy liberated as electron drops to larger space-time sheet.

The fact that continual di-electric breakdown is involved means second kind of criticality and the requirement that liberated zero point kinetic energy in the dropping of electron corresponds to the ionization energy of titanium atom for  $n = 3$  valence electron makes also the phenomenon quantum critical.

These considerations suggest some ideas concerning optimization and possible variants of the Searl device. Perhaps a more important manner to optimize is based on the condition of quantum criticality some of whose aspects are now understood. Hall effect for the radial Ohmic current plays a key role in generating torque and this raises the question whether quantum Hall effect at low temperatures involving increases of conductivity by 13 orders of magnitude could maximize the torque.

### 4.1.2 Possible other similar systems

There are anomalies related to the behavior of rotating gyroscopes [H27] , [J23] suggesting that rotating gyroscope can lose part of its weight. There are a claims about energy production with apparent efficiency larger than unity [H6, H20] by machines which contain rotating magnets. The explanation would be based on the basic mechanism explaining the functioning of Searl device. Radial ohmic current charges the systems and generates usable electrostatic energy. The flow of ohmic current in term involves time mirror mechanism involving the emission of phase conjugate photons received by the magnetic walls generated by the rotating system, which contain dark matter.

The appendix of the book gives a summary about basic concepts of TGD with illustrations. There are concept maps about topics related to the contents of the chapter prepared using CMAP realized as html files. Links to all CMAP files can be found at <http://www.tgdtheory.fi/cmaphtml.html> [L8]. Pdf representation of same files serving as a kind of glossary can be found at <http://www.tgdtheory.fi/tgdglossary.pdf> [L9]. The topics relevant to this chapter are given by the following list.

- Magnetic body [L19]
- Basic Mechanisms associated with magnetic body [L11]
- Hierarchy of Planck constants [L17]
- Rotating systems and dark matter [L26]

## 4.2 Summary about the New Physics effects predicted by TGD

The basic new physics effects predicted by TGD relate to the many-sheeted character of space-time, to the new view about the relationship between gravitational and inertial energy, to the possibility of negative inertial energies and reversal of geometric arrow of time, and to the classical long range electro-weak and color fields.

### 4.2.1 The new view about the relationship between gravitational and inertial energy

At the level of quantum physics negative energy photons would correspond to a system quantized in such a manner that both bosonic and fermionic annihilation and creation operators have changed their roles. Negative energy photons and fermions do not correspond to (non-existing) "anti-photons" and anti-fermions. Using the terminology of Dirac's bra-ket formalism: negative energy

systems are like bras if positive energy photons are kets. Kets and bras correspond to Hilbert space and linear functionals defined in it. The space of bras is actually not equivalent with that of kets but in a well defined sense a more general concept. This conforms with the role of negative energy space-time sheets in TGD inspired theory of consciousness. One can distinguish between ordinary phase of matter and phase conjugate phase. In ordinary phase matter has positive energy and antimatter negative energy. In phase conjugate matter the roles of matter and antimatter have changed.

In quantum field theories time reversal transforms creation operators for fermions to creation operators for anti-fermions. Vacuum state is not changed. Time reversal in TGD sense would transform ket vacuum to bra vacuum so that the earlier creation operators annihilate the new vacuum state and genuine negative energy states result. This would suggest that negative energy states are something genuinely new and a genuine outcome of the many-sheeted space-time concept allowing either bra and ket type vacuum at a given space-time sheet. It has become that this view explains elegantly matter-antimatter asymmetry whose origin is one of the deepest problems of cosmology.

The new view leads also to an elegant understanding of the problematic issues related to the relationship between inertial and gravitational energy [K80, K17, K68]. TGD predicts and exact conservation of inertial and the most elegant and economic theory results when the net inertial energy of Universe vanishes. This view is certainly consistent with the crossing symmetry of elementary particle physics allowing to interpret particle reactions as a creation of states with vanishing net quantum numbers from vacuum, with outgoing particles representing negative energy states.

The non-conservation of gravitational energy is an empirical fact in cosmological scales and the identification of the gravitational energy as the difference of positive inertial energy of matter and negative inertial energy of antimatter implies that gravitational energy density is non-vanishing and non-conserved. This resolves also the puzzle caused by the prediction that net inertial energy density vanishes in TGD inspired cosmology.

This picture leads to a rather detailed view about cosmology. The so called cosmic strings, which gradually transform to magnetic flux tubes with increasing thickness (and weaker magnetic field strength), are the key players of TGD inspired cosmology in all length scales. Magnetic factors have the same role also in TGD inspired biology. Since matter and phase conjugate matter correspond to a different direction of the arrow of geometric time, one can say that phase conjugate matter, which is mostly inside negative energy cosmic strings and magnetic flux tubes, obeys the second law of thermodynamics in a time reversed direction in geometric sense. Entropy increases but the process proceeds towards geometric past so that the resulting decay looks like self assembly from the point of view of an observer consisting of positive energy matter. Cosmic evolution would a homeostasis in which two opposite tendencies tending to increase and reduce entropy are competing. Second law in the standard form would apply only to the positive energy half of the Universe so that Universe would not be approaching heat death as the usual belief goes.

The vanishing of the inertial mass of a system leads to rather dramatic effects if positive energy and negative energy systems can form bound states, since this kind of system would be "feather light" although it still has non-vanishing gravitational mass. Even tiniest force could kick this kind of system to motion. If positive and negative energy systems do not form bound state they behave like their own independent subsystems and Equivalence Principle is satisfied in a good approximation. The formation of bound states of positive and negative inertial energy systems could provide a road to a new energy technology and perhaps even allow to create matter from vacuum by space-time engineering by generating vacuum extremals which represent space-time sheets with vanishing density of inertial energy.

### 4.2.2 Generalized four-wave mechanism as a basic mechanism of remote metabolism

Generalized four-wave mechanism provides a concrete realization for the more general time mirror mechanism underlying remote metabolism and many other mechanism important for the functioning of the living matter in TGD Universe. Generalized four-wave mechanism also provides a connection with the existing physics of phase conjugate waves.

### Time mirror mechanism

Time mirror mechanism (see fig. <http://www.tgdtheory.fi/appfigures/timemirror.jpg> or fig. 24 in the appendix of this book) could make possible new technologies such as instantaneous remote energy utilization, instantaneous active remote sensing, and instantaneous communications over arbitrarily long distances. Time mirror mechanism is an essential element in the models of remote metabolism, long term memory, intentional generation of motor actions, sensory perception, and remote mental interactions. What happens that negative energy topological light rays propagating to the direction of the geometric past are reflected back in time direction and return as positive energy topological light rays (photons could accompany the rays).

This apparently paradoxical sounding language makes sense since the experienced time corresponds to a sequence of quantum jumps recreating space-time surface again and again and the correspondence between these times follows from quantum-classical correspondence: the contents of conscious experience in the essentially four-dimensional classical universe are dominated by contributions, which are sharply localized with respect to the geometric time. This creates the illusion that the classical universe is 3-dimensional. It is essential that the field equations determining the space-time surfaces as field analogs of Bohr orbits are not fully deterministic. Only this makes it possible for the classical dynamics to mimic the non-deterministic quantum dynamics.

Negative energy topological light rays can induce the dropping of ions from atomic to larger space-time sheets. The liberated zero point kinetic energy means that the system can act as an over-unity energy source.

In many-sheeted space-time particles topologically condense at all space-time sheets having projection to given region of space-time so that this option makes sense only near the boundaries of space-time sheet of a given system. Also p-adic phase transition increasing the size of the space-time sheet could take place and the liberated energy would correspond to the reduction of zero point kinetic energy. Particles could be transferred from a portion of magnetic flux tube portion to another one with different value of magnetic field and possibly also of Planck constant  $h_{eff}$  so that cyclotron energy would be liberated. In the following only the "dropping" option is discussed.

Negative energy topological light rays, presumably having phase conjugate laser waves as standard physics counterparts, would be accompanied by negative energy photons and these would induce the dropping of charged particles to larger space-time sheets without emission of photons. The experiments of Feinberg, in particular the experiment in which a chicken was irradiated by phase conjugate laser waves, demonstrate that the system was transparent to phase conjugate laser waves at visible lengths. Indeed, if the phase conjugate photons have negative energies above the thermal energy, say at energies corresponding to visible wave lengths, there is no excited atomic system able to absorb negative energy photons inducing the return to the ground state.

The pairs of atomic and larger space-time sheets can act as many-sheeted population inverted lasers with frequencies which are universal constants of nature, and defined as differences of zero point energies whose values are predicted by the p-adic length scale hypothesis. If the intensity of the negative energy photons is above some critical value, the particles in the excited state of the many-sheeted population inverted laser drop to the ground state in a cascade like manner (the probability of dropping of charged particle is proportional to the number of charged particles already present at larger space-time sheet and thus to the intensity and duration of negative energy topological light ray irradiation). The time reflection thus involves an amplification and negative energy photons serve only the role of controller. The system becomes over-unity energy source making possible remote energy utilization.

### Four-wave interaction and time mirror mechanism

Four-wave interaction is the basic mechanism producing phase conjugate laser waves, and TGD approach leads to a generalization of this [I37] [K12]. Four-wave interaction becomes the basic mechanism of intentional action and is behind the basic biological and brain functions like (actually remote) metabolism and long term memory. The findings of Tiller [J28] about physical correlates of intentional action find a nice explanation in this framework.

There are several open questions about four-wave interaction. Could four-wave interaction or its generalization provide a deeper understanding of the scaling law of homeopathy stating that low and high frequencies appear in pairs [K32]? Could the basic function of probe and conjugate

beams be the amplification of the standing wave interference pattern by remote metabolism? Does the standing wave formed by the reference beams serve as a kind of standardized hologram? Is it possible to generalize the notion of hologram in order to get rid of the reference beams?

The standing wave interference pattern represents a synchronous oscillation of the entire system and would be an excellent physical correlate for the ability of living organisms to act as coherent wholes. The standing wave resulting as the interference pattern of waves propagating in opposite directions would serve kind of a standardized hologram parameterized by the wavelength  $\lambda_h$ . The interference pattern can be also kicked into a motion by Lorentz boost, and the propagation velocity of the interference pattern is an additional characteristic of the pattern.

Probe and phase conjugate beams in four-wave interaction could in turn be interpreted in terms of remote metabolism. System sends negative energy topological light rays (or massless extremals, MEs) to the geometric past and receives as a response positive energy MEs, and amplification can occur in this process so that negative energy signal serves only a role of control signal. Its generation would utilize the energy provided by the remote metabolism. The emission of negative energy ME would switch on the positive energy laser of the geometric past generating probe beam. The energy source could be system in its geometric past or some system in the environment.

Standing wave is basic element of the mechanism and its generation would require energy obtained by emitting phase conjugate photons. Standing wave need not result only as an interference of classical em wave propagating in opposite directions, but could correspond to any standing wave. Plasma resonances are an especially interesting candidate for a standing wave since plasma frequency does not depend on wave vector at all in lowest approximation. This means that there is no dispersion and the pattern formed by plasma waves is oscillatory. I have indeed proposed that this kind of plasma wave patterns are in key role in living matter. Besides electromagnetic plasma wave patterns also classical  $Z^0$  plasma waves are possible if nuclei possess anomalous  $Z^0$  charges as suggested in [K71, K23]. The plasma wave pattern would get the energy of its self-organization by sending (say) negative energy photons.

One can imagine a metabolic hierarchy which is obtained by a time reversal from the dissipation hierarchy for which energy from long length scales gradually dissipates to short length scales. The dissipation of the energy of a hydrodynamic vortex by the gradual decay to smaller vortices is a basic example of this process. Now this kind of process would be replaced by a self-assembly starting from the most energetic level and involve radiation of phase conjugate waves with decreasing frequency scales. The lowest level would correspond to ordinary metabolic mechanism, magneto-static waves could be at the next level and the counterparts of magneto-static waves for Cooper pairs at magnetic flux tubes could be also present and correspond to very low frequencies.

In living matter metabolic energy feed corresponds to the "pumping" and drives protons back to the atomic space-time sheets, and the same would be true now. This hints to a somewhat pessimistic conclusion from the point of view of over unity enthusiast: if the system gains its energy by dropping its own protons to larger space-time sheets, it cannot work for too long. This might relate to the continually occurring optimistic reports about free energy production followed by silence. The point of over unit technology would not be however tapping endlessly energy about vacuum but the possibility of remote metabolism which could make un-necessary for system to carry energy storages with itself and allow extreme flexibility and instantaneous generation of energy when needed.

### 4.2.3 The classical $Z^0$ fields as TGD counterpart for torsion fields

TGD predicts the existence of classical long ranged fields identified in terms as space-time correlates of scaled down copies of ordinary weak bosons [K23] identifiable as various forms of dark matter. Already low energy hadrons and nuclei involve dark forms of valence quarks and nuclei also exotic quarks with masses in MeV range. Exotic quarks couple to light variants of weak bosons with weak length scale  $L_w$  of order atomic length scale. Nuclei can develop anomalous weak isospin. Entire hierarchy of scaled down variants of weak bosons is unavoidable prediction of TGD if one takes quantum classical correspondence seriously. This means that under certain circumstances also  $Z^0$  electric fields can cause detectable effects. For instance, the TGD based explanations of the tritium beta decay anomaly [C23] and the anomalous variation of the radio active decay rates [E20], [E20] involve the interaction of small sized objects with weak fields.

Even local  $Z^0$  neutrality of condensed matter, which could be due to dark neutrino screening,

does not exclude the possibility of  $Z^0$  magnetic fields. Thus rotating macroscopic objects could generate  $Z^0$  magnetic fields and the claimed properties of the torsion fields [H52, H14] are very much like those of  $Z^0$  magnetic fields. In particular, also classical  $Z^0$  field has parity breaking axial coupling to elementary particles, and large parity breaking effects are predicted (chiral selection in living matter has explanation along these lines).

The generation of classical  $Z^0$  magnetic field might be involved with the large parity breaking observed in the experiments of Roshchin and Godin [H49] (the critical rotation velocities were different for clockwise and counterclockwise rotations). Note however that also the sign of vacuum charge density involves parity breaking effect irrespective whether em or  $Z^0$  field is in question. It is however clear that the radial electric fields generated by rotation can only serve as a seed for the em and  $Z^0$  charging of the roller system inducing the effective loss of weight in the Earth's em and  $Z^0$  fields. What happens is that radial ohmic currents of electrons and neutrinos are created and this leads to the em and  $Z^0$  charging of the system and therefore to the effective loss of weight in the em and  $Z^0$  electric fields of Earth. It is also possible that flux structures carry combination of magnetic and  $Z^0$  magnetic fields and the strange shell like magnetic field structures could be accompanied also by  $Z^0$  magnetic fields.

#### 4.2.4 Gravitational anomalies and many-sheeted space-time

TGD space-time is many-sheeted surface in  $H = M_+^4 \times CP_2$ , which can be regarded as the future light-cone of Minkowski space with points replaced with  $CP_2$  having size about  $10^4$  Planck lengths. One can visualize the space-time sheets as almost parallel pieces of plane glued together by wormhole contacts and also connected by join along boundaries bonds<sup>1</sup>. The distance between the sheets is of order  $CP_2$  radius. This makes possible anti-gravitation like effects since a macroscopic object (itself a space-time sheet containing hierarchy of smaller space-time sheets glued to it) can feed its gravitational flux to several space-time sheets. A modification of the standard distribution of gravitational flux between various space-time sheets could produce gravitational anomalies at a given space-time sheet, in particular modify the effective gravitational mass.

What about the effects of redistribution on gravitational flux on the motion of the system?

1. Newtonian intuition would suggest that the gravitational force experienced by the object is replaced with

$$F_{gr} = \sum_i \frac{M_i}{M} F_{gr,i} , \quad (4.2.1)$$

where the summation over space-time sheets is understood. This means that the simple Newtonian picture fails and the determination of the gravitational constant can give varying values.

2. In relativistic picture the motion in absence of external forces occurs along geodesic lines or rather, tubes made out of them. The distribution of gravitational fluxes would mean a fractal superposition of geodesic motions in different length scales. As far as the motion of given space-time sheet  $X^3$  as seen from imbedding space level is considered, the largest space-time sheet receiving gravitational flux determines the rough pattern of motion and smaller space-time sheets add smaller details to it. The redistribution of gravitational gauge fluxes can only affect the initial values of three-momenta at a given space-time sheet  $X_i^4$ .

The original hypothesis was that the redistribution of gravitational flux could dominate the change of weight as it is manifested in the motion of the system according to Newtonian intuition in rotating magnetic systems. It however turned out that the generation of em and  $Z^0$  charges and interaction with the Earth's corresponding fields explain dominant part of the weight change and also the spontaneous acceleration.

<sup>1</sup>For illustrations see my home page <http://www.tgdtheory.fi/illua.html>.

### 4.2.5 Questions related to the vacuum charge densities associated with rotating systems

The experiments of Faraday related to a rotation of cylindrical magnet with conductor disk attached rigidly on its top, are not well known to average physicist [H6] . The outcome these experiments was that radial electric field is generated between the rim and axis of the rotating conducting disk. This effect does not follow from Faraday's law of induction and is not satisfactorily understood in Maxwell's electrodynamics and it is somewhat surprising that Faraday's experiment has not received more attention.

#### A mere rotation of a 3-surface carrying magnetic field generates vacuum charge density

One can understand the generation of the radial electric field in Faraday's experiment by assuming that the rotation of the rotating system corresponds geometrically to a rotating 3-surface carrying magnetic field. The induction of the potential difference could be regarded as a direct evidence for 3-space as 3-surface concept! The mere rotation of 3-surface very probably does not give rise to absolute minimum of Kähler action but it could be that the actual absolute minimum is obtained as a small deformation of the orbit of rotating 3-surface.

One reason why for the presence of the radial electric field is that it guarantees stability of the rotating condensed matter in conducting disk.

1. Assume that rotating Faraday disk generates vacuum charge density the sign of which depends on the direction of rotation. The reason for the generation of the electric field could be the stability of the condensed matter: rotating nuclei suffer magnetic force  $e\mathbf{v} \times \mathbf{B}$  and the Coulomb force created by the radial electric field cancels this force.
2. Charge density can be calculated as divergence of the radial electric field compensating magnetic Lorentz force. The required electric field has the magnitude

$$E = \omega Br , \quad (4.2.2)$$

where  $r$  is radial cylindrical coordinate. The corresponding charge density is given by

$$n_V = \frac{\omega B}{e} . \quad (4.2.3)$$

[The units  $\hbar = c = 1$  are used].

3. It seems that the required charge density  $n_V$  cannot be due to a re-arrangement of the density of the conduction electrons since in this case there would be large parity breaking differentiating between two rotation directions. Thus some kind of vacuum polarization effect must be in question. In standard physics vacuum polarization effects are purely local and its is difficult to see how one could generate macroscopic polarization effects. In TGD however point like particles are replaced by 3-surfaces and vacuum polarization could thus generate new space-time sheet.

#### Does charge conservation require that new space-time sheet is created when vacuum charge density is generated

In TGD particles are not point like but correspond to 3-surfaces so that vacuum polarization typically leads to a generation of double-sheeted space-time surfaces carrying opposite classical quantum numbers such as charge and energy. Charge conservation requires that the two space-time sheets carry opposite charge densities. Since the distance of the space-time sheets in  $CP_2$  direction is of order  $CP_2$  length about  $10^4$  Planck lengths, the generation of the new space-time sheet with opposite charge density can be indeed regarded as a local vacuum polarization mechanism.



Besides vacuum bubble interpretation also energetic considerations suggest that the new space-time sheet has negative time orientation since only in this case the creation of the new space-time sheet does not cost energy. It however increases the energy of the material space-time sheet and this might give clue to the understanding of what is involved with the explanation of over unity devices involving rotating magnetic systems. Needless to say, the instability of the vacuum against generation of negative energy space-time sheet in principle could make possible generation of entire galaxies from vacuum: human kind or our followers might some day take the role of God!

### Does the generation of vacuum charge density relate to the generation of # contacts

Vacuum charge density at given space-time sheet could be realized in several manners.

1. The field equations associated with the preferred extremals of Kähler action allow vacuum charge densities unlike vacuum Maxwell equations. The reason is that primary dynamical variables are not the Maxwell gauge potentials defined by the induced Kähler form but imbedding space ( $H = M_+^4 \times CP_2$ ) coordinates in terms of which the induced Kähler form defining classical Maxwell field, is expressible. Electromagnetic field is superposition of Kähler field and certain component of  $CP_2$  spinor curvature. In the approximation that gravitational effects are neglected, field equations reduce to empty space Maxwell's equations locally and it is not clear whether rotating 3-surface suitable deformed could correspond to a solution of field equations. Charge conservation requires that opposite charge density is realized to the space-time sheet at which the space-time sheet of the rotating cylinder feeds its gauge fluxes via wormholes. This space-time sheet could be also material space-time sheet having positive time orientation so that the generation of the gauge fields would require energy.
2. Charge density could be also understood as resulting from the wormhole throats feeding electric flux between two space-time sheets: the two throats have opposite gauge fluxes behaving effectively as classical charges by Gauss's Law. The basic rule of the game is that wormhole contacts (see fig. <http://www.tgdtheory.fi/appfigures/wormholecontact.jpg> or fig. 10 in the appendix of this book) reside at the boundaries of the space-time sheets and can give rise to effective surface charge densities only. Wormhole contacts at boundaries are certainly present and feed gauge fluxes between space-time sheets. Thus charge density in the interior cannot correspond to wormhole contacts if this rule is OK. Wormhole contacts correspond at quantum level parton pairs. Partons are assignable to the light-like 3-D causal horizons associated with wormhole contacts [K28]. If the time orientations of the space-time sheets are of opposite sign these parton pairs can have vanishing net inertial energy. The density of these parton pairs could serve as a correlate for vacuum charge density. It should be noticed that around # contacts modelled as  $CP_2$  type extremals the  $CP_2$  projection of space-time surface is necessarily  $D \geq 3$ -dimensional so that vacuum extremals cannot be in question.
3. The splitting of the wormhole contacts is possible and can give rise to fermions carrying there electroweak quantum numbers on the resulting boundaries of the holes of a split wormhole contact. For instance, electron-positron pairs could be created. It seems most natural to assume that resulting fermion pairs are ordinary fermions and electron-positron pairs are the simplest possibility. One can of course question the assumption that electrons are 'ordinary'. For closed space-time sheets this is certainly not the case but now new space-time sheet has boundaries and is much like material space-time sheet but possibly having finite time duration. Therefore a reasonable *working hypothesis* is that electrons and positrons created in this manner behave like ordinary electrons and positrons except that the sign of energy is different at the new space-time sheet. It is quite possible that the rotating 3-surface, which is the first guess for the space-time surface describing rotating system, is not imbeddable globally and that the failure of the imbeddability at 3-dimensional surfaces gives rise to boundary components with size of order  $CP_2$  size and identifiable as elementary particles.

## 4.3 About strange effects related to rotating magnetic systems

The inspiration for writing this section (rewritten for many times when I am writing this) came from the publication of Godin and Roshchin in Russian journal *New Energy Technologies* [H49], which A. V. Frolov kindly sent to me. The article gives very valuable quantitative information about the anomalies related to the rotating magnetic systems.

A tentative conclusion about the strong parity breaking effects involved is that classical  $Z^0$  force must play an important role in the effect, and perhaps give a dominating contribution to the effect. The rotating magnetic system develops vacuum em and  $Z^0$  charges by a mechanism discovered already by Faraday and not consistent with Maxwell's theory. This charge turns out to be too small to induce effective weight change. The radial em and  $Z^0$  electric fields however induce radial ohmic electron and exotic neutrino currents and the leakage of corresponding charges from the system. The resulting charges couple to the Earth's electric and  $Z^0$  electric fields. The sign of the em (unlike  $Z^0$ ) force depends on the direction of rotation and this explains parity breaking effect. The generation of charge explains the plasma phase and the resulting Lorentz force explains the mechanical stability of the rollers in Searl's original device against a centrifugal acceleration. The Lorentz torque experienced by the ohmic currents implies spontaneous accelerated rotation above a critical frequency determined from the condition that the Lorentz torque proportional to frequency is larger than the friction torque.

An alternative explanation for the spontaneous rotation would be in terms of the reduction of inertial mass of the rotating magnetic system, which combined with angular momentum conservation would explain elegantly the spontaneous accelerated rotation of the system as a pirouette effect. Also the redistribution of the gravitational flux of the system between larger space-time sheets must be assumed. The required generation of gravitational mass from vacuum is measured in kilograms and seem to be unrealistically high.

This argument does not exclude the generation of gravitational mass from vacuum in smaller amounts. The generation of inherently unstable vacuum extremals self-organizing to positive and negative energy space-time sheets might be involved. Therefore one must consider seriously the possibility that positive and negative energy inertial energy is created from vacuum in amounts determined by the density of magnetic energy associated with the strange magnetic walls accompanying the system. Interestingly, for vacuum extremals  $Z^0$  and em field are proportional to each other:  $Z^0 \simeq -8\gamma$  so that it might be possible to understand also the generation of classical  $Z^0$  fields and  $Z^0$  magnetization of the system.

The new view about energy has led to a variant of the generalized four-wave mechanism based on magnetostatic waves as a manner to suck energy from environment. This mechanism could provide the kinetic energy for the accelerated magnetic system.

### 4.3.1 The experiment, the observed effects, and their interpretation in TGD framework

It is convenient to start with a brief description of experiment, observed effects, and their interpretation in TGD framework.

#### The experiment

The experiments of Roshchin and Godin [H49] involve a magnetic system consisting of ring like stator magnet and rotor consisting of 23 cylindrical magnets (rollers) in ring along the rim of the stator and free to roll along the rim. The outer radius of stator was .5 m. The air gap between stator and roller surfaces was  $\delta = 1$  mm. According to [H47], the ratio of the radius or roller to stator radius was taken to be an integer  $N$  not smaller than 12 in order to make possible magnetostatic resonance.

The entire system rested on a platform carried by springs so that the possible changes in the weight of the system could be deduced from the change of the equilibrium position. The weight of the system with the platform included was 350 kg.

The roller and stator carry magnetic fields which are in opposite directions. Both consist of segments which are rare earth magnets (neodymium): the total amounts of neodymium used to

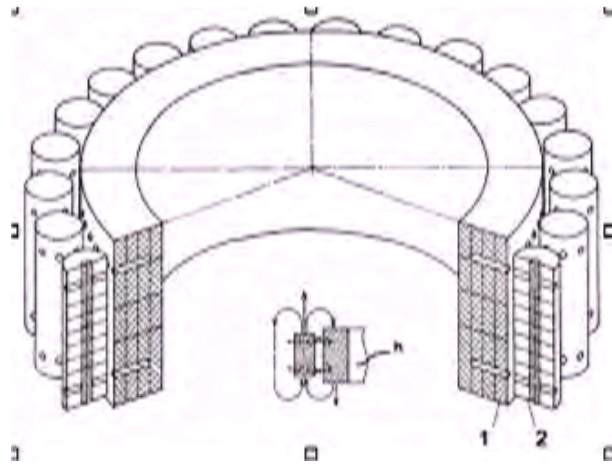

Figure 4.1: Variant of one-ring converter (figure 25 in [H47]).

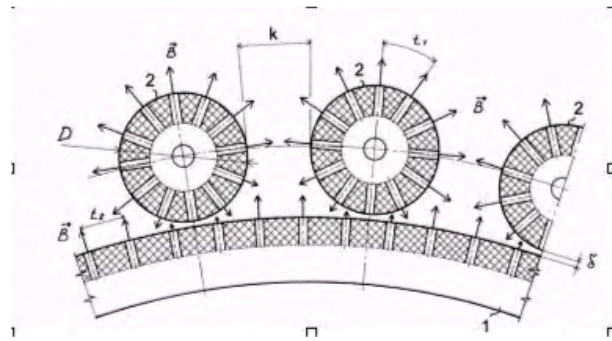

Figure 4.2: The general view of the converter and its platform (figure 26 in [H47]).

construct stator and rotor magnets were 110 and 115 kg. The strength of the residual induction was 1 Tesla. The magnetic field was not precisely vertical since cross-magnetic inserts having a flux vector of 1.2 Tesla orthogonal to the primary magnetization vector were added on both the stator and rollers. The distance between roller and stator inserts was same and there were 12 inserts per roller (and hence  $N \times 12 \geq 12^2$  inserts for stator). The natural guess is that the function of the resulting periodic gradients in magnetization helps to make the stator and rotor magnets to a kind of magnetic cogwheels forcing smaller magnets to roll rather than only rotate without translational motion since slipping would generate a torque. More details about the magnetic structure of the stator and roller magnets can be found in [H47].

The system contained arrangement allowing to arrange a high voltage of 20 kV between stator and rotor with plus pole corresponding to stator. This voltage is much higher than the voltage caused by the rotation measured in volts.

### The observed effects

Several strange effects were observed and it seems that TGD based model is now sufficiently well understood to explain them. Figure 1 (figure 28 of [H47]) representing the relative weight loss  $\Delta G/G_0$  for *clockwise* rotation as a function of rotation frequency  $f$  gives a good overall view about the situation.

1. In the initial situation rotor magnets were rotated using electric motor. Above some critical

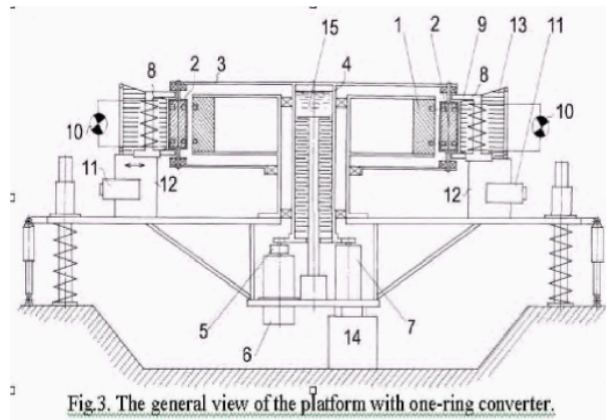

Figure 4.3: Magnetic inserts could make possible magnetic cogwheel mechanism (figure 27 in [H47]).

clockwise rotation velocity the system started to lose weight. The displacement meter started to detect the change of weight at 200 rpm. The gradient  $\frac{d(\Delta G/G_0)}{df}$  satisfied everywhere the condition

$$\frac{d(\Delta G/G_0)}{df} > 0 ,$$

and below 550 rpm it was increasing as the inspection of the graphical representation of [H47] shows. At 550 rpm which corresponds to 9.1 Hz the system starts to accelerate spontaneously and the electric motor was decoupled. At 550 rpm the weight loss is 30 per cent and in the interval 30-31 per cent the rotation speed accelerates to about 600 rpm which corresponds to 10 Hz. The gradient of the weight loss  $\Delta G/G_0$  as function of rotation frequency  $f$  became very small at 550 rpm.

For the reasons of mechanical stability a gradually increasing load is coupled to system so that the angular acceleration is reduced and the curve for  $\Delta G/G_0$  as function of  $f$  develops a shoulder. The replacement of continual acceleration with a shoulder is basically due to the load. The maximum weight loss was 35 per cent and reached at about 600 rpm above which the experimentation was not possible due to the problems with the mechanical stability. The load was increased in units of 1 kW up to 7 kW. A load larger than 7 kW results in a gradual decrease of the rotation speed and an exit from the self-sustained mode. Note that mass equivalent for the generation of energy with the rate of 7 kW is  $7.8 \times 10^{-13}$  kg/s.

The coupling of 20 kV voltage affects the diagram characterizing the rotation velocity as a function of weight loss by increasing the value of rotation velocity for a given weight loss as also the coupling of load does. In the presence of voltage with output power 7 kW the rotation frequency begins to decrease at the maximum weight loss of 35 per cent from 600 rpm whereas the effective weight remains constant down to 400 rpm.

2. There is a strong parity breaking involved. Depending on whether the direction of rotation is clockwise or counter clockwise weight is reduced or increases. The critical mode appears around 550 rpm for a clockwise rotation and around 600 rpm for a counter clockwise rotation. Searl has reported also the modification of radioactive decay rates in the vicinity of the Searl device. The presence of classical  $Z^0$  (and possibly  $W$ ) besides em force could explain this kind of effects. It must be noted that already the generation of the radial vacuum electric field in the roller magnet means spontaneous parity breaking. The mere electromagnetic charging of the rollers in the Earth's electric field cannot however explain the different critical rotation frequencies for the two rotation directions.

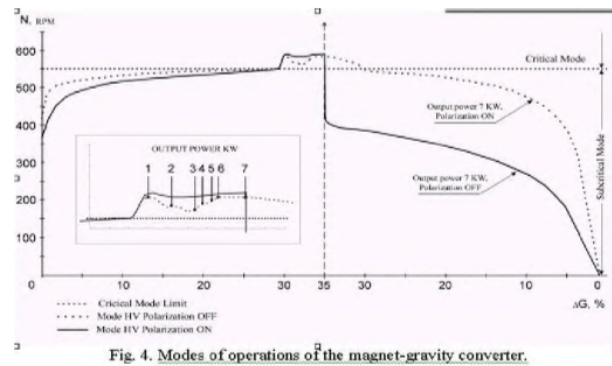

Fig. 4. Modes of operations of the magnet-gravity converter.

Figure 4.4: The development of the change of weight as function of rotation frequency (figure 28 in [H47]).

3. During the self-sustained mode a cooling of the environment in the vicinity of the magnetic system is observed. A stable fall of the common temperature 22 C of laboratory by 6-8 degrees was observed. This suggests violation of the second law. The sucking of energy from environment by a phase conjugate mechanism could be involved. That phase conjugate waves are involved was proposed also in the article of Dr. Paul la Violette [H33]. Phase conjugate microwaves generated by magnetostatic waves are the best candidate for the generalized standing waves (actually rotating around stator magnet). The reason is that for sufficiently long wavelengths the dispersion relation does not depend on wavelength so that arbitrary wave pattern repeats itself periodically with a frequency which is expressible in terms of Larmor frequencies of electron in the fields defined by the magnetization and by the external field (now the field of roller inside stator).
4. In a dark room corona discharges are observed around the converter rotor as a blue-pink glowing luminescence and a characteristics ozone smell. The cloud of ionization covers the area of a stator and rotor and has therefore a toroidal shape. Also a series of horizontal yellowish-white luminescent bands spaced along the height of the roller surface and separated from one other by about a roller radius were observed. This suggest a high voltage electron discharge from the surface of the roller magnets. It was however not accompanied by sounds characteristic of arc discharge, which suggests an emission coming from a larger surface rather from a point source.

The plasma could be due to the electromagnetic charging of the the rollers. Roller system would consequently experience the force caused by the Earth's em and  $Z^0$  electric fields implying the effective loss of weight. The radial electric field generated by Faraday effect in rotating systems could induce an Ohmic current leading to a partial leakage of the charge to the space-time sheets of environment: part of charge would flow to larger space-time sheets associated with the rollers and would only induce a many-sheeted polarization of the roller system.

The luminescence resembles high voltage microwave induced luminescence observed prior to the point of electrical breakdown. Microwave radiation associated with the self-organizing magnetostatic waves might be in question. For electrons in a field of 1 Tesla the frequency of these waves is around Larmor frequency  $f_L \simeq 12$  GHz and corresponds to a wavelength of about 2.5 cm. The ionization of the air suggested by the presence of blue light perhaps identifiable as electronic excitation line of ionized  $N_2$  molecule, requires the presence of electrons with energies of order keV.

5. Concentric magnetic walls with a reduction of temperature inside them begin to appear at 200 rpm. The strength of magnetic field depends approximately linearly on the rotation speed and increases up to .05 Tesla. The maximal temperature drop is 8 C. The walls are

separated by a distance of about .5 m which is the radius of the stator and the thickness of the wall is about 5-6 cm.

Intriguingly, the Larmor frequency for the maximal .05 Tesla magnetic field associated with walls corresponds to .6 GHz and wavelength of .5 meters, the radius of the stator. Hence this magnetic field strength might relate to a microwave resonance at cyclotron frequency and with a wavelength equal the radius of the stator, and somehow providing the energy needed by the system accelerating spontaneously. Lowest cyclotron transitions and spin flip transitions inside magnetic walls would have this frequency naturally and the magnetic walls would appear at the nodes of the waves.

The direction of the magnetic field inside the walls coincides with the direction of the magnetic field created by rollers and is same as the direction of the return flux of the magnetic field of stator+roller system. The interpretation as a spontaneous magnetization associated with the Cooper pairs forming a Bose-Einstein condensate at the space-time sheet of the magnetic wall allows to understand the spontaneous acceleration of the rollers. Remote metabolism in which phase conjugate microwaves induce spontaneous magnetization liberating energy takes care of energetics. The rollers generate angular momentum by transforming the electronic spin and angular momentum to the angular momentum of the roller and compensate the lost spin by spin flips accompanied by a remote spontaneous magnetization of the magnetic walls to achieve angular momentum conservation. Also the rotation of electrons in the magnetic fields of the rollers could be effective generator of recoil angular momentum.

The thickness of the magnetic walls about 5-6 cm is somewhat larger than the roller radius 3.7 cm and twice the wavelength 2.5 cm of the microwaves possibly generated by self-organizing magneto-static waves at Larmor frequency and rotating around the stator. The Larmor frequency associated with magnetic walls when spontaneous rotation starts corresponds to a wavelength of .5 m which brings in mind resonance mechanism. The generalized four-wave mechanism involving microwaves at both 2.5 cm and .5 m wavelengths strongly suggests itself as a mechanism making possible the spontaneous acceleration. Magnetostatic waves generated in stator are good candidates for a building block of the mechanism.

### The minimal model explaining the effects

The basic question is whether both the reduction of the inertial mass, increase of effective gravitational mass, and classical em and  $Z^0$  forces are needed. The minimal model involves only the classical em and  $Z^0$  forces.

1. The fact that the sign of the weight change depends on the direction of rotation suggests a large parity breaking effect. Already the mechanism generating radial electric field induces spontaneous parity breaking and ordinary charging and Earth's electric field might explain the effect. The effect has however a slightly different dependence on rotation frequency for two rotation directions and this requires the presence of also  $Z^0$  field. The presence of the repulsion or attraction due to the classical em and  $Z^0$  electric fields of Earth on the rotator having em and  $Z^0$  charges increasing with rotation frequency  $f$  is a good candidate for the explanation of the strong parity breaking. These forces would be induced by the radial em and  $Z^0$  electric fields induced by the rotating  $Z^0$  magnetic field created by the spinning rollers and inducing in turn radial ohmic currents of electrons and neutrinos from rollers and hence em and  $Z^0$  charging of the system. The basic test of the model is to look how electric in the vertical direction affects the behavior of the system.
2. The spontaneous acceleration might rely on a variant of so called ball bearing motor mechanism [H33]. The radial current of  $Z^0$  charge due to  $Z^0$  Faraday effect flowing through the space-time sheet containing  $Z^0$  magnetic field of the roller ring suffers a Lorentz torque in the magnetic and  $Z^0$  magnetic fields. Similar em torque appear in the space-time sheets of rollers. When the rotation velocity is so high that the resulting torque proportional to rotation frequency is larger than the frictional torque, the system starts to accelerate. Together with Faraday effect this leads to a positive feedback loop. This mechanism explains also the different critical angular velocities for clockwise and counter clockwise directions of rotation and provides the most economical model for the Searl effect.

### 4.3.2 The electric fields associated with rotating magnetic fields

The radial electric fields associated with rotating magnets were discovered already by Faraday. The direction of field depends on the direction of rotation and field gives rise to charge density. This means strong parity breaking effect difficult to understand in standard physics framework. Also classical  $Z^0$  fields are involved and the idea that the radial  $Z^0$  electric field generates neutrino flow to larger space-time sheets and thus a net density of  $Z^0$  charge turns out to be key element in the model of Searl device.

#### Are the rotating magnetic systems consistent with Maxwell's equations?

Faraday's observation that rotating magnetic generates radial electric field  $E = \omega\rho B$  is only marginally consistent with Maxwell's equations due the presence of a charge density which changes sign when the direction of rotation is changed. In TGD these fields are possible.

TGD allows purely geometric vacuum charge densities with no elementary particles acting as charge carriers. In particular, if ones 'kicks' a 3-surface containing a constant magnetic field into a rotational motion, vacuum charge density results. This is seen by considering a simple model for the imbedding of a magnetic field  $B_z(\rho)$  as an induced gauge field in  $M_+^4 \times S^2$ , where  $S^2$  is a geodesic sphere of  $CP_2$ . In spherical coordinates  $(\cos(\Theta), \Phi)$  for  $S^2$  the electromagnetic component of  $CP_2$  spinor connection is

$$A_\Phi = \cos(\Theta) \quad (4.3.1)$$

apart from a multiplicative numerical constant. The induced em gauge potential is

$$A_\mu = A_\Phi \partial_\mu \Phi \quad (4.3.2)$$

as a projection of the component of the spinor connection to the space-time surface. In cylindrical coordinates  $(t, z, \rho, \phi)$  for  $M_+^4$  one has for the imbedding of magnetic field as an induced gauge field

$$\cos(\Theta) = f(\rho) \quad , \quad \Phi = n\phi \quad , \quad B_z(\rho) = \partial_\rho A_\phi = \partial_\rho f n \quad , \quad (4.3.3)$$

where  $n$  is integer. Note that the imbedding necessarily fails at some critical radius since  $\cos(\Theta)$  cannot be larger than one: this is nothing but topological field quantization of magnetic field to flux tubes.

When the magnetic 3-surface is 'kicked' to a rotating motion one has

$$\cos(\Theta) = f(\rho) \quad , \quad \Phi = n(\phi - \omega t) \quad , \quad (4.3.4)$$

and an electric field

$$E_\rho = \partial_\rho A_t = -\omega\rho B \quad (4.3.5)$$

is generated.

The condition  $E_\rho = vB = \omega\rho B$ , which can be interpreted as the vanishing of the net Lorentz force locally, gives rise to a vacuum charge density

$$\rho_{vac} = \nabla \cdot E = -\omega B \quad (\text{in units } \hbar = c = 1) \quad . \quad (4.3.6)$$

The sign of the vacuum charge density depends on the direction of rotation. This means a large parity breaking effect. It is very difficult to understand how the sign of the charge density could depend on the direction of rotation if charge carriers were ordinary elementary particles. Thus this effect, observed already by Faraday, seems to be in conflict with Maxwell's theory and to support TGD.

Charge conservation requires that the radial electric gauge flux of vacuum goes somewhere at the boundary of the magnet space-time sheet. The only possibility is that a new space-time sheet is generated parallel to the magnet space-time sheet (unless it exists already). The electric flux runs through wormhole contacts or join along boundaries bonds to this space-time sheet and back in radial direction at the second space-time sheet. If this space-time sheet has negative time orientation (guaranteeing that the sign of the electric field as tensor component  $F_{0r}$  changes), it has also negative energy, and energy conservation requires that the rotating system gets positive compensating energy.

### The fields associated with the rolling magnets

At theoretical level the situation in the case of magnets rolling along the rim of stator ring does not differ essentially from the simpler case if one neglects the effects caused by the criticality of the preferred extremals in the sense of having an infinite number of deformations for which the second variation of Kähler action vanishes. One can also apply the description below to the calculation of both em and  $Z^0$  fields.  $Z^0$  electric fields would be present only in a system perform rolling motion. In the following only the electromagnetic case is discussed.

The rolling magnet is described by a space-time sheet containing an axial magnetic field and characterized by the mapping of  $M_+^4$  to  $S^2$ , where  $S^2$  is a geodesic sphere of  $CP_2$ .  $M_+^4$  has local cylindrical space-time coordinates  $(t, z, \rho, \phi)$  and  $S^2$  spherical coordinates  $(u = \cos(\Theta), \Phi)$ .

1. A stationary system non-rotating cylindrical magnet corresponds to the surface

$$u = f(\rho), \quad \Phi = n\phi .$$

In this case the magnetic field is of form

$$B = n\partial_\rho u .$$

For a set of parallel magnets one must find imbedding for the superposition of the magnetic fields and the expression generalizes to

$$B = \frac{\partial(u, \Phi)}{\partial(\rho, \phi)} ,$$

which is just the Jacobian for the mapping from x-y-plane to  $S^2$  defined by the matrix of partial derivatives.

2. The rotating, but not rolling magnet, is obtained by the replacement

$$t \rightarrow t, \rho \rightarrow \rho, \phi \rightarrow \phi - \frac{\omega}{n}t = \hat{\phi} .$$

The magnetic and electric fields are obtained by a standard tensor transformation formula for antisymmetric space-time tensors and one has in the case of single magnet

$$B = \frac{\partial(u, \Phi)}{\partial(\rho, \hat{\phi})} , \quad E = B \frac{\partial(\rho, \hat{\phi})}{\partial(\rho, t)} = \frac{\omega}{n}B .$$

3. The rolling magnetic system is obtained from the stationary one by kicking the space-time sheet to a rolling motion

$$u = f(\hat{\rho}), \quad \Phi = n\hat{\phi} ,$$

where one has

$$\rho \rightarrow \hat{\rho} = \sqrt{(x - x(t))^2 + (y - y(t))^2} , \quad \phi \rightarrow \hat{\phi} = \arctan\left(\frac{(y - y(t))}{(x - x(t))}\right) - \frac{\omega}{n}t .$$



The motion of the center of mass of roller along a ring of radius  $R$  is given by

$$(x(t), y(t)) = R \times (\cos(\Omega t), \sin(\Omega t)) \quad .$$

In the rolling coordinate system there is only magnetic field  $\hat{B}(\hat{\rho}, \hat{\phi}) \equiv \hat{B}$  present, and one can obtain the magnetic and electric fields in stationary system by tensor transformation formulas:

$$B(\rho, \phi) = \hat{B} \frac{\partial(\hat{\rho}, \hat{\phi})}{\partial(\rho, \phi)} \quad ,$$

$$E(\rho, \phi) = \hat{B} \frac{\partial(\hat{\rho}, \hat{\phi})}{\partial(t, \phi)} \quad ,$$

For  $\Omega = m\omega$ ,  $m$  integer, the electric and magnetic fields are period with respect to time with frequency  $\omega$  and one can expect resonance effects.

### 4.3.3 A classical model for the weight change and spontaneous acceleration involving only em and $Z^0$ fields and Faraday effect

The assumption about the reduction of inertial mass by one per cent needed to explain the spontaneous acceleration seems hard to take seriously, and one must ask whether less exotic mechanisms generating the spontaneous acceleration could be imagined.

In the article of LaViolette [H33] a modification of the so called ball-bearing motor effect combined with the Faraday effect is discussed as a positive feedback mechanism leading to the angular acceleration of the system. Ball bearing motor contains an inner conducting cylinder able to rotate and coupled to the wall of the outer cylinder by ball bearings, which do not slide with respect to the inner cylinder. When a radial voltage gradient exists between the cylinders, a radial current  $j$  flows through the bearings and Lorentz force

$$F = \int_{bb} j \times B dV \sim IBV_{bb}$$

acting on bearing in a tangential direction is generated and creates a torque  $\tau = F(R + r)$ , where  $R$  and  $r$  are the radii of the inner and outer cylinder (subscript  $bb$  refers to ball bearing in the formula). The current keeps the cylinder in a rotating motion if given an initial torque.

The idea described in [H33] is that one can regard the rotating rollers as a single rotating ring and that Faraday effect generates also now a radial electric field  $E = v \times B$  through the ring. The estimate for the corresponding maximum voltage through the roller is

$$V = \pi B f ((R + r)^2 - R^2) \quad .$$

For  $f_{max} = 23 \times 10$  Hz,  $R = .5$ m and  $r = .07$  m, and  $B = 1$  Tesla this gives  $V = 2$  Volts. Using the estimate  $R = 460 \mu\text{Ohm}$  for the resistance of the roller, one finds that the current is about  $I = 4300$  A. Using the previous formula one can make an order of magnitude estimate for the resulting torque on single roller as  $\tau \sim IBrR \sim 140$  Nm. The sign of the torque changes with the direction of rotation and conforms with the fact that angular acceleration is observed for both directions of rotation.

On the other hand, from the observed angular acceleration during the spontaneous acceleration one obtains the estimate for the torque suffered by single roller:

$$\tau \sim M_r r^2 2\pi \frac{\Delta f}{\Delta t} \quad ,$$

where one has  $\Delta f \sim 45$  rpm and  $\Delta t \simeq 5$  sec. For the roller mass  $M_r \sim 100$  kg/23 this gives  $\tau \sim .45$  Nm, which is by two orders of magnitude smaller than the first estimate. Something goes wrong.

One can indeed criticize the model. The assumption that all the angular momentum gained by the electron current is transferred to the roller is probably wrong. The extreme situation is that the current flows out freely through the boundaries of the roller and roller itself receives no

angular momentum. A more serious objection is following. The net radial current associated with single spinning but non-rolling roller vanishes: why shouldn't the radial electric field of the roller simply rotate around the stator so that no radial electric field would be generated?

### A general model for the observed change of the effective weight change below critical velocity

A general model for the effective weight change relies on the following assumptions (in the following the units  $\hbar = c = 1$  are used).

1. There are classical em and  $Z^0$  forces present due to the approximately constant radial em and  $Z^0$  electric fields of Earth besides the elastic force of springs with elastic constant  $k$ .
2. The inertial mass and gravitational masses of the system can change.
3. The gravitational acceleration due to the Earth's gravitational field can suffer a reduction  $g \rightarrow \epsilon g$ ,  $\epsilon \leq 1$  due to the redistribution of the gravitational flux between space-time sheets.

#### 1. General parameterization of the model

The following set of equations represents a parameterization for this picture.

1. The em and  $Z^0$  forces experienced by unit em and  $Z^0$  charge per given

$$F_{em} = eE_{em} \quad , \quad F_Z = g_Z E_Z \quad .$$

Here  $g_Z$  corresponds to  $Z^0$  coupling constant strength  $\alpha_Z$  is related to the fine structure constant  $\alpha_{em} = e^2/4\pi$  by

$$\alpha_Z = \frac{g_Z^2}{4\pi} = \frac{\alpha_{em}}{\sin(\theta_W)\cos(\theta_W)} \quad , \quad \alpha_{em} \simeq \frac{1}{137} \quad , \quad \sin^2(\theta_W) \simeq .23 \quad . \quad (4.3.7)$$

is  $Z^0$  coupling strength.

2. At the equilibrium height  $h$  the acceleration  $a$  vanishes, and one has

$$a = -\epsilon(f)g + \frac{Q_Z(f)g_Z E_Z + Q_{em}(f)eE_{em}}{m(f, \pm)} + \frac{kh}{m(f, \pm)} = 0 \quad . \quad (4.3.8)$$

It is assumed that inertial mass can change in the process so that one has  $m = m(f, \pm)$ . This gives for the equilibrium height  $h$  the expression

$$h(f, \pm) = \epsilon(f) \frac{m(f, \pm)g}{k} \pm \frac{Q_Z(f, \pm)g_Z E_Z + Q_{em}(f, \pm)eE_{em}}{k} \quad . \quad (4.3.9)$$

$Q_{Z/em}(f, \pm)$  refers to the absolute value of the  $Z^0/em$  charge.

If one erratically (at least in TGD Universe) assumes that only ordinary gravitational force is present, one would have

$$\begin{aligned} \frac{\Delta [m_{eff}(f, \pm)]}{m_0} &= \frac{k\Delta h(f, \pm)}{m_0 g} \\ &= \left[ \epsilon(f) \frac{m(f)}{m_0} - 1 \right] \mp \frac{Q_Z(f, \pm)g_Z E_Z + Q_{em}(f, \pm)eE_{em}}{m_0 g} \quad , \end{aligned} \quad (4.3.10)$$

2. What information one can deduce from the graph of rotation frequency as function of relative weight change?

Consider now what conclusions one can make from the graph of the rotation frequency  $f$  as function of relative weight change  $\Delta G/G_0$  depicted in figure 1.

1. The fact that the spontaneous acceleration starts at the same value of effective weight change for both directions of rotation supports the view that the change of inertial mass is negligible, at least below the critical rotation frequency. If there is no redistribution of the gravitational flux neither below the critical frequency, one has

$$m(f, \pm) = m_0 \text{ and } \epsilon(f) = 1 \text{ for } f < f_{cr}(\pm) . \quad (4.3.11)$$

2. Below the critical mass change of  $\mp 30$  per cent the situation is completely symmetric in both cases unless the functions  $Q_{Z/em}(f, +)$  and  $Q_{Z/em}(f, -)$  are different: this cannot be the case since the critical frequencies are different. The fact that the values of critical weight changes are same means that the value of the absolute magnitude of  $em+Z^0$  force are in the role of the critical quantity. On basis of the behavior of the these functions below the critical frequency, it seems safe to assume that they can be regarded as almost constant above  $f_{cr}(\pm)$ .
3. The observed graph of rotation frequency  $f$  as a function of  $\Delta G/G$  has a step around  $f_{cr}$  which develops to a shoulder: frequency grows first rapidly whereas the weight change remains practically constant. The development of shoulder is due to the addition of a load taking the energy otherwise available for a spontaneous acceleration and generating a torque. The simplest explanation for the spontaneous acceleration involves only classical  $em$  and  $Z^0$  Faraday effect and generalization of the ball bearing motor effect.

### TGD variant of ball bearing effect

The Lorentz torque giving rise to ball bearing effect involves two contributions. The first contribution corresponds to a radial electron current moving in a radial electric field associated with rollers. Second contribution becomes from  $Z^0$  current induced by the radial  $Z^0$  electric field associated with the space-time sheet of the roller ring. This current consists of electrons and neutrinos. Electronic part experiences both the magnetic field of roller and  $Z^0$  magnetic field of the roller ring.

#### 1. The Lorentz torque associated with the roller

Also the electrons of the radial Ohmic current of the roller experience in magnetic field of the roller a torque in the axial direction. If the angular momentum of the roller is conserved, an opposite torque affecting the roller itself should be generated. If the electronic current changes its direction from radial to slightly non-radial in the magnetic field (essentially Hall effect), the electrons leaking out from the roller leave it non-radially and carry out net torque so that compensating torque affects the roller system. When electrons do not leak out but are reflected back at the atomic space-time sheets the resulting current experiences torque which tends to cancel the torque. If a reflection of the current at the boundary occurs to larger space-time sheet this does not occur and a net torque results. It is convenient to introduce a parameter, call it  $\epsilon$ , to characterize what part of electronic torque gives rise to a torque acting on the roller.

Using Ohm's law, one can write the torque in the form

$$\tau_{em} = \epsilon \int_{roller} j \times B dV = \epsilon \sigma_e \omega B^2 \times \frac{2\pi}{3} (r_o^3 - r_i^3) h . \quad (4.3.12)$$

where  $r_o$  and  $r_i$  are the inner radii and  $h$  the weight of the roller.  $\epsilon$  is the factor telling which part of the electric torque is transformed to a torque affecting on the roller.  $\omega$  refers to the rotation frequency of the roller.

If the only contribution to the torque is electromagnetic, one cannot understand the asymmetry with respect to the direction of rotation. The radial  $Z^0$  electric field is proportional to  $\omega^2$  since  $Z^0$  magnetic field is generated by rotation and proportional to  $\omega$  and this would explain the asymmetry. The fact that em contribution must dominate in torque gives a rough estimate

$$\epsilon \sim \frac{1}{5}$$

by using a direct estimate of torque from the observation angular acceleration during the period when spontaneous acceleration occurs freely.

### 2. The Lorentz torque associated with the roller ring

In TGD framework the roller ring as a single system would correspond to a larger space-time sheet and the magnetic fields of rollers are not at this space-time sheet. The spinning rollers however create a  $Z^0$  magnetic field at the space-time sheet of the roller ring and the rotation of the rollers around the stator generates a radial  $Z^0$  electric field via  $Z^0$  Faraday effect. If electrons feed their  $Z^0$  electric flux to this space-time sheet, they experience the classical  $Z^0$  force, the torque due to both magnetic and  $Z^0$  magnetic fields as well as the ordinary dissipation. Same applies to neutrinos. If the currents in question are not able to leak out freely from the roller space-time sheet, some fraction of the torque on current carriers acts on the roller itself and induces a spontaneous acceleration. The neutrino contribution to the radial current could dominate since  $Q_Z(e)$  is roughly 1/50 times smaller than  $Q_Z(\nu)$ .

The predicted torque can be written as

$$\begin{aligned} \tau_Z &= (\epsilon_e F_e + \epsilon_\nu F_\nu) \times r \ , \\ F_e &= \sigma_e \int_{roller} \frac{Q_Z(e)g_Z}{e} E_Z \times [B + Q_Z(e)B_Z] dV \\ F_\nu &= \sigma_\nu \int_{roller} Q_Z(\nu) E_Z \times Q_Z(\nu) B_Z dV \ . \end{aligned} \quad (4.3.13)$$

Here one has  $E_Z = v \times B_Z$  and  $r$  denotes position vector from the origin of stator. The parameters  $\epsilon_e < 1$  and  $\epsilon_\nu < 1$  characterize the fraction of the torque on current carriers transmitted to a torque acting on the roller.

The sign of the em contribution depends on the direction of rotation whereas  $Z^0$  contribution is of the same sign since already  $B_Z$  is proportional to the rotation velocity. Since spontaneous angular acceleration starts at different critical frequencies,  $\tau_{em}$  must dominate over  $\tau_Z$ , which is however present and for which the em Lorentz force acting on electron must dominate.

Electron's  $Z^0$  coupling is by a factor  $\sim 1/50$  weaker than em coupling. For  $B_Z \simeq .4$  Tesla to be deduced from the model for magnetic walls the em Lorentz force dominates and gives a contribution which is of same sign for both directions of rotation. For  $\epsilon_e = \epsilon$  the ratio of electromagnetic torque deduced above and  $Z^0$  Lorentz torque would be very roughly of order

$$\frac{\tau_Z}{\tau_{em}} \sim Q_Z(e) \times \frac{r}{R} \simeq .08 \ .$$

where  $r/R \simeq .1$  has been used. This is consistent with the difference  $(f_{cr,+} - f_{cr,-})/f_{cr,+} \simeq 1/11$ .

Neutrino current gives a contribution changing sign with the rotation direction and thus cannot give the dominant part to the  $Z^0$  torque. This gives

$$\epsilon_\nu \leq \epsilon_e \frac{\sigma_e}{\sigma_\nu} \frac{Q_Z(e)eB}{Q_Z(\nu)g_Z B_Z} \text{ per.}$$

If neutrino conductivity scales as  $\sigma_\nu/\sigma_e \simeq m_e/m_\nu \sim 5 \times 10^6$  then the estimate  $\epsilon_\nu \sim 10^{-9}$  follows for  $g_Z B_Z \simeq .4$  Tesla. Experimental data do not allow to deduce whether exotic neutrino current is present or not.

The voltage of  $U = 20$  kV between stator and the electrodes at the outer rims of the rollers has an observable effect of order few per cent on the rotation velocity. If this situation is comparable to the discussed one, one must have

$$\epsilon_e < \frac{10^{-7}}{x} ,$$

where  $x$  is the fraction of voltage  $U$  over the roller. It is not clear from [H47] whether the voltage is over distance  $r$  ( $x = 1$ ) or  $R + r$  ( $x = 1/11$ ). This estimate is quite different order of magnitude as the estimate for  $\epsilon_e \sim 1/5$  characterizing the Lorentz torque generated by the radial current in the roller. This suggests that the two situations are quite different.

This is indeed the case: the point is that both the stator and rollers are surrounded by a copper foil which acts as a Faraday cage meaning that the voltage at the surface of the foil is constant and the electric field created by 20 kV voltage does not penetrate inside. The rollers and stator behave effectively like electrodes of a capacitor.

### The model for positive feedback neglecting "back reaction"

It is good to start with a model neglecting the negative feedback due to energetic constraints and indicated by the fact that 7 kW load leads to a slowing down of the system. Hence only positive feedback is present and can be modelled explicitly.

The first observation is that friction implies the presence of a torque which can be modelled in the lowest approximation as being proportional to the rotation frequency  $\omega$ :

$$\tau_{fr} = Ik\omega . \quad (4.3.14)$$

Note that  $\omega$  is 23 times the rotation frequency  $\Omega$  of the roller and  $230 \times 2\pi$  Hz for  $\Omega = 10 \times 2\pi$  Hz. Assuming that the induced  $Z^0$  magnetic field is proportional to  $\omega$ , the angular acceleration can be parameterized as

$$\frac{d\omega}{dt} = \frac{\tau}{I} = P_3(\omega) = a\omega + b(\omega^2 + \frac{1}{\omega_{cr}}\omega^3) - k\omega . \quad (4.3.15)$$

Here the term  $a\omega$  corresponds to a purely electromagnetic torque resulting from the radial ohmic current inside roller, the term proportional to  $b$  to the two  $Z^0$  magnetic contributions, whereas the term  $k\omega$  corresponds to the friction.  $Z^0$  term dominates for  $\omega \gg \omega_{cr}$ . One can pose as a convention the conditions

$$b \geq 0 , \quad \omega_{cr} \geq 0 . \quad (4.3.16)$$

#### 1. Qualitative behavior of the system

The qualitative behavior of the system can be deduced from quite general arguments generalizing in a straightforward manner to the more realistic case.

1. The equilibrium points (stable or unstable) correspond to the zeros

$$P_3(\omega) = \omega \left[ a - k + b\left(\omega + \frac{1}{\omega_{cr}}\omega^2\right) \right] = 0 \quad (4.3.17)$$

of the third order polynomial appearing at right hand side of Eq. 4.3.15 representing vanishing net torque.

2. The first zero is  $\omega = 0$ : for  $a - k > 0$  this zero is unstable since Lorentz torque wins friction torque in linear approximation and the system begins to accelerate. According to Searl, his own device indeed starts to spontaneously accelerate and would thus correspond to this situation. For  $a - k < 0$  friction torque wins and the system comes to rest unless the initial rotation frequency is above critical frequency. The device of Godin and Roschin corresponds to this situation. Searl's device requires that the friction is reduced sufficiently and the

magnetic field is strong enough. The use of electromagnets instead of ferromagnets might allow to achieve this situation. The increase of electrical conductivity has the same effect. What is interesting is that quantum Hall effect involves increases of conductivity by thirteen orders of magnitude as the strength of the magnetic field is varied. The explanation is in terms of fusion of the magnetic flux tubes to walls at certain critical field strengths: along these current can run freely without sticking around single flux tube. Whether something similar might occur now in low temperatures in radial direction, is an interesting open question.

3. The two other zeros correspond to the roots of the second order polynomial appearing in the above equation.
  - i) If the roots are real, they correspond to two critical frequencies  $\omega_{\pm}$ . Suppose that the roots are of different sign:  $\omega_{+} > 0$  and  $\omega_{-} < 0$ . This requires  $a - k < 0$ . The system studied by Godin and Roschin corresponds to this kind of situation. If  $|\omega| \leq |\omega_{\pm}|$  holds true the system decelerates to  $\omega = 0$ . The rotation with frequency  $\omega_{\pm}$  does not represent a stable situation and a slight increase of the frequency above  $|\omega_{\pm}|$  implies a spontaneous acceleration without limit, which represents an unrealistic feature of the model.
  - ii) Roots can be also of same sign: this requires  $a - k > 0$ . In this case a spontaneous acceleration without limit occurs always for the other rotation direction. For the other direction it occurs without limit only above the root with a larger magnitude. In the region between  $\omega_{+}$  and  $\omega_{-}$  deceleration occurs until the smaller root is achieved. Below the smaller root the system accelerates to the smaller root. Hence the rotation with the smaller rotation frequency represents a stable situation.
  - iii) If the roots are complex, the system accelerates without limit for both directions of rotation. The reason is that  $a - k > 0$  is necessary to achieve this situation.

### 2. Quantitative analysis

Consider now the quantitative analysis of the model neglecting the "back reaction". The roots of the second order polynomial correspond to an unstable motion with a constant rotational velocity and are given by

$$\omega^2 + \omega_{cr}\omega + \frac{(a-k)\omega_{cr}}{b} = 0 . \quad (4.3.18)$$

This gives

$$\begin{aligned} \omega_{\pm} &= -\frac{B}{2} \pm \frac{1}{2}D , \\ D &= \sqrt{B^2 - 4C} , \quad B = \omega_{cr} , \quad C = \frac{(a-k)\omega_{cr}}{b} . \end{aligned} \quad (4.3.19)$$

There are three different cases depending on whether the discriminant  $D = B^2 - 4C$  is positive or negative or zero.

#### $D > 0$ case

This situation corresponds to

$$a - k < \frac{b\omega_{cr}}{4} . \quad (4.3.20)$$

and means that critical frequencies  $\omega_{\pm}$  are real.

Solving the differential equation in this case gives

$$\frac{\omega}{\omega(0)} \times \left[ \frac{\omega - \omega_{+}}{\omega(0) - \omega_{+}} \right]^{\frac{\omega_{-}}{D}} \times \left[ \frac{\omega - \omega_{-}}{\omega(0) - \omega_{-}} \right]^{-\frac{\omega_{+}}{D}} = e^{(a-k)t} . \quad (4.3.21)$$

One can distinguish between two different cases corresponding to the sign of  $a - k$ .

1. For  $a - k < 0$   $\omega_+$  and  $\omega_-$  have different sign. The magnitude of the critical frequency is different for the two different directions of rotation as observed in the experiment of Godin and Roschin and this is due to the torque suffered by  $Z^0$  ohmic electron current  $j = \sigma_e E_Z$  in the ordinary magnetic field.

For  $|\omega(0)/\omega_{\pm}| < 1$  the system decelerates to  $\omega = 0$ . For  $|\omega(0)/\omega_{\pm}| > 1$   $|\omega|$  becomes infinite in a finite time at the limit

$$t \rightarrow t_{\infty} = \frac{1}{b(a-k)} \log \left[ \frac{(\omega(0) - \omega_+)}{\omega(0)} \times \left( \frac{\omega(0) - \omega_-}{\omega(0) - \omega_+} \right)^{-\frac{\omega_-}{\omega_- - \omega_+}} \right] \quad (4.3.22)$$

The spontaneous acceleration without limit occurs for both clockwise and counter clockwise rotation but the values of the parameter  $t_{\infty}$  are slightly different:

$$t_{\infty,+} - t_{\infty,-} = \log \left[ \frac{1-x}{1+x} \right] \frac{1}{b(a-k)}, \quad x = \frac{\omega_+}{|\omega(0)|}. \quad (4.3.23)$$

2. For  $a - k > 0$  the roots are of same sign and smaller frequency corresponds to a stable situation to which system either accelerates or decelerates. The larger rotation frequency is unstable and an acceleration without limit occurs above it. In this kind of stationary situation friction and Lorentz torque compensate each other. For other rotation direction spontaneous acceleration without limit occurs always. This situation could correspond to Searl's device.

#### $D < 0$ case

This situation corresponds to

$$a - k > \frac{b\omega_{cr}}{4}. \quad (4.3.24)$$

It can occur only for  $a - k > 0$ . In this case the roots  $\omega_{\pm}$  are complex, and one can express the solution in the form

$$\begin{aligned} \frac{1}{x} \times (X + Y) &= e^{(a-k)t}, \\ X &= \log \left[ \frac{\omega}{\omega(0)} \times \left( \frac{\omega^2(0) + \omega(0)\omega_{cr} + x}{\omega^2 + \omega\omega_{cr} + x} \right)^{1/2} \right] \\ Y &= -\left(\frac{D}{4}\right)^{3/2} \times \left[ \arctan \left[ \frac{\omega + \omega_{cr}}{\frac{D}{4}} \right] - \arctan \left[ \frac{\omega(0) + \omega_{cr}}{\frac{D}{4}} \right] \right] \\ x &= \frac{(a-k)\omega_{cr}}{b}, \quad D = \omega_{cr}^2 - 4x < 0. \end{aligned} \quad (4.3.25)$$

A spontaneous acceleration without limit occurs always and  $\omega = \infty$  is achieved in a finite time

$$\begin{aligned} t_{\infty} &= \log \left[ \frac{1}{x} (X(\infty) + Y(\infty)) \right], \\ X(\infty) &= \log \left[ \frac{(\omega^2(0) + \omega(0)\omega_{cr} + x)^{1/2}}{\omega(0)} \right] \\ Y(\infty) &= -\left(\frac{D}{4}\right)^{3/2} \times \left[ \frac{\pi}{2} - \arctan \left[ \frac{\omega(0) + \omega_{cr}}{\frac{D}{4}} \right] \right] \end{aligned} \quad (4.3.26)$$

*D = 0 case*

For  $D = 0$  one has  $\omega_+ = \omega_-$  and an exponential acceleration without limit results:

$$\omega = \omega(0)e^{(a-k)t} . \quad (4.3.27)$$

The model discussed is certainly unrealistic. In particular, the prediction that infinite value of  $\omega$  is reached in a finite time interval is non-sensible.

### The model taking into account the "back reaction"

The model just described is an idealization.

1. Fast rotation would induce so strong a centrifugal force that it would overcome the mechanical constraints and the radial Lorentz force experienced by the rollers in the magnetic field of the stator. Acceleration to an infinite velocity in a finite time would require a infinitely high power feed at the limit and the effectiveness of the remote metabolism poses a restriction here. Godin and Roschin found that the load above which the system starts to decelerate is  $P_{max} = 7$  kW. From this one can estimate the maximum power feed from remote metabolism to the accelerating system using the condition

$$P_{max} = I\omega_{max} \frac{d\omega}{dt} = I\omega_{max} \left[ (a-k)\omega_{max} + b(\omega_{max}^2 + \frac{1}{\omega_{cr}}\omega_{max}^3) \right] \quad (4.3.28)$$

2. The negative feedback resulting from the finite efficiency of metabolism can be modelled by adding to the equation of motion negative feedback term, a kind of analog of "radiation reaction" for linear motion. The simplest guess is that the negative feedback term is proportional to the time derivative of the angular acceleration:

$$\begin{aligned} \tau_{fb} &= -t_0 \frac{d^2\omega}{dt^2} = t_0 \frac{d(\frac{d\omega}{dt})}{d\omega} \frac{d\omega}{dt} = -t_0 P_3(\omega) \frac{dP_3}{d\omega} . \\ P_3(\omega) &= (a-k)\omega + b(\omega^2 + \frac{1}{\omega_{cr}}\omega^3) . \end{aligned} \quad (4.3.29)$$

The net angular acceleration can be written as

$$\frac{d\omega}{dt} = P_3(\omega) \left[ 1 - t_0 \frac{dP_3}{d\omega} \right] = P_3(\omega) \left[ 1 - (a-k)t_0 - 2bt_0\omega - \frac{3bt_0}{\omega_{cr}}\omega^2 \right] . \quad (4.3.30)$$

3. During spontaneous acceleration a load increasing in steps of 1 kW is added to the system. The simplest model for the load is as a friction term. The assumption that the torque describing the presence of load is of the form

$$\tau_L = -Ik_L\omega . \quad (4.3.31)$$

means only a modification of the friction coefficient  $k$ :  $k \rightarrow k - k_L$ . The power used by the load is given by

$$P_L = \tau_L\omega = Ik_L\omega^2 . \quad (4.3.32)$$



Applying this equation to the stationary situation  $\omega = \omega_{1\pm}$  one can deduce the value of  $k_L$ .

$$k_L = \frac{P_L}{I\omega_{1\pm}^2} . \quad (4.3.33)$$

The resulting equations of motion are integrable. Besides the roots of  $P_3(\omega)$  defining stable or unstable orbits for which the angular acceleration vanishes, the roots of  $dP_2/d\omega$  define additional orbits of this kind when real. The roots are given by

$$\omega_{1\pm} = \frac{\omega_{cr}}{3} \left[ \pm \sqrt{1 + 3 \times \frac{k + k_L - a + \frac{1}{t_0}}{\omega_{cr}b}} - 1 \right] \quad (4.3.34)$$

For

$$k + k_L - a \geq \frac{\omega_{cr}b}{3} - \frac{1}{t_0}$$

(in particular for  $k + k_L - a > 0$ ) the roots are real and represent stable orbits stabilized by the negative feedback and representing asymptotic situation in the case that the system starts to spontaneously accelerate above  $|\omega| > |\omega_{\pm}|$ . For sufficiently small values of  $t_0$  the condition for stable orbit is satisfied always. This condition guarantees also the physically natural condition  $|\omega_{1\pm}| \geq |\omega_{\pm}|$ . Also for  $a - k > 0$  one expects that  $t_0$  is for purely physical reasons so small that roots are real so that stable orbits result.

More explicitly, the equations of motions read

$$\begin{aligned} \int \frac{d\omega}{P_5(\omega)} &= \omega_{cr}t , \\ P_5(\omega) &= \frac{3b^2t_0}{a\omega_{cr}^2} \omega(\omega - \omega_+)(\omega - \omega_-)(\omega - \omega_{1+})(\omega - \omega_{1-}) \equiv A^{-1} \prod_{k=1}^5 \frac{\omega - \omega_k}{\omega_{cr}} , \\ A &= \frac{a}{3b^2\omega_{cr}^3t_0} , \end{aligned} \quad (4.3.35)$$

and give

$$\begin{aligned} A \times \log \left[ \prod_{k=1}^5 \left[ \frac{\omega - \omega_k}{\omega(0) - \omega_k} \right]^{c_k} \right] &= \omega_{cr}t , \\ c_k &= \prod_{l \neq k} \frac{\omega_{cr}}{\omega_k - \omega_l} . \end{aligned} \quad (4.3.36)$$

Note that one has  $\sum_k c_k = 0$ , which implies that the argument of logarithm approaches constant for large values of  $\omega$ . Depending on the initial conditions and the sign of  $k - a$  the system approaches the limit  $t \rightarrow \infty$  either  $\omega = \omega_{1\pm}$  or  $\omega = 0$ .

### Catastrophe theoretic model for the dynamics of Searl device

Rene Thom's great achievement was the topological classification of different very rapid, almost discontinuous, catastrophic changes appearing in potential flow dynamics [A16]. The value of the catastrophe theory is that it gives an overall view of the dynamics of a complex non-linear system. The form of equations of motion is precisely the canonical form of equations to which catastrophe theory applies as such.

The dynamics of the system can be regarded as a potential flow with the torque derived from a potential function  $V(\omega)$ . Taking "back reaction" into account one has

$$\begin{aligned}
\frac{d\omega}{dt} &= \frac{dV(\omega)}{d\omega} , \\
V(\omega) &= \int P_3(\omega)d\omega - t_0 \frac{P_3^2}{2} , \\
P_3(\omega) &= (a - k - k_L)\omega + b(\omega^2 + \frac{1}{\omega_{cr}}\omega^3) , \\
\int P_3(\omega)d\omega &= \frac{1}{2}(a - k - k_L)\omega^2 + \frac{1}{3}b\omega^3 + \frac{1}{4}\frac{b}{\omega_{cr}}\omega^4 .
\end{aligned} \tag{4.3.37}$$

The limit when the back reaction is not taken into account corresponds to the limit  $t_0 = 0$ . In this case the potential function is fourth order polynomial in  $\omega$  and corresponds to the cusp catastrophe. In the general case the potential function is sixth order polynomial in  $\omega$  so that the dynamics of the model corresponds to the butterfly catastrophe. Cusp and butterfly and swallowtail represent basic catastrophes with one behavior variable in Thom's topological classification of catastrophes [A16].

1. *Cusp catastrophe as a model for the system without back reaction*

In order to understand the character of the butterfly catastrophe it is good to start from the cusp catastrophe which describes sudden changes in a bistable system described by a potential having the canonical form

$$V(x) = \frac{x^4}{4} - ax - b\frac{x^2}{2} .$$

There is one behavior variable  $x$  and two control parameters  $a, b$ . The system allows in the generic case three equilibrium points as roots of  $dV/dx = 0$ . Two of them are stable and one unstable. The illustration of the cusp catastrophe is provided by the figure 4.3.3.



Figure 4.5: Cusp catastrophe

Searl device without back-reaction would be described by the dual of the dual cusp catastrophe allowing one stable point and at most two unstable points for given values of the parameters corresponding.

The potential function  $V(\omega)$  is not quite the same form as for the canonical form of the cusp catastrophe but can be transformed to it by a linear change of the behavior variable.

1. Introduce first the dimensionless variables

$$\omega \rightarrow \hat{\omega} \frac{\omega}{\omega_{cr}} , \quad t \rightarrow T = b\omega_{cr}t , \tag{4.3.38}$$

transforming the potential to a dimensionless function of a dimensionless argument

$$\begin{aligned}\frac{d\hat{\omega}}{dT} &= \frac{d\hat{V}(\hat{\omega})}{d\hat{\omega}} , \\ \hat{V}(\hat{\omega}) &= \frac{V}{b\omega_{cr}^3} = \frac{1}{2}(\hat{a} - \hat{k})\hat{\omega}^2 + \frac{1}{3}\hat{\omega}^3 + \frac{1}{4}\hat{\omega}^4 , \\ \hat{a} &= \frac{a}{b\omega_{cr}} , \quad \hat{k} = \frac{k + k_L}{b\omega_{cr}} .\end{aligned}\tag{4.3.39}$$

2. This form differs from standard from only by the fact that also  $\hat{\omega}^3$  term is present and the absolute value of  $\hat{\omega}$  appears in the linear term. By performing the transformation

$$\hat{\omega} \rightarrow \Omega = \hat{\omega} + 1\tag{4.3.40}$$

this term disappears and one obtains

$$\begin{aligned}\frac{d\Omega}{dT} &= \frac{dW(\Omega)}{d\Omega} , \\ W(\Omega) &= \frac{1}{2}(\hat{a} - \hat{k})(\Omega - 1)^2 + \frac{1}{3}(\Omega - 1)^3 + \frac{1}{4}(\Omega - 1)^4 , \\ &= -A\Omega - \frac{B}{2}\Omega^2 + \frac{1}{4}\Omega^4 + \text{constant} , \\ A &= \frac{a - k - k_L}{\omega_{cr}} , \quad B = -1 - \frac{a - k - k_L}{\omega_{cr}} .\end{aligned}\tag{4.3.41}$$

This is the canonical form of the cusp catastrophe potential. In the canonical representation of the cusp catastrophe  $\Omega$  is referred to as a state variable whereas  $A$  and  $B$  as control variables.  $A$  is called the normal factor and corresponds now to the external load. Its variation over a critical value in the region  $B > 0$  induces a rapid catastrophic reduction of  $\Omega$ .  $B$  is known as the splitting factor and corresponds now to the variable  $a - k$ : the catastrophe can occur only in the region  $B > 0$  where the fold appears: in recent case this corresponds to the condition

$$\frac{a - k - k_L}{\omega_{cr}} < -1 .\tag{4.3.42}$$

$a - k - k_L$  is indeed negative in the experiment of Godin and Roschin.

## 2. Butterfly catastrophe as a model for the system with back reaction

Butterfly catastrophe has one behavior variable, which is now  $\omega$ , and 4 control parameters so that the graph of the function  $dV/d\omega = 0$  represents a four-dimensional surface in the 5-dimensional space spanned by  $\omega$  and control parameters. Butterfly catastrophe models a situation in which there are at most three stable equilibrium points instead of two as in the case of cusp catastrophe. A typical application is a qualitative model for the sudden changes in the distribution of opinions (hawks, doves present already for the cusp plus liberals). In the case considered the three stable situations correspond for  $k + k_L - a > 0$  to  $\omega = 0$  and  $\omega = \omega_{1\pm}$  whereas the roots  $\omega_{\pm}$  corresponds to unstable intermediate situations.

The canonical form of the potential for butterfly catastrophe is

$$V(x) = \frac{x^6}{6} - ax - b\frac{x^2}{2} - c\frac{x^3}{3} - d\frac{x^4}{4} \quad (4.3.43)$$

and one ends up to this form by performing a scaling and shift of  $\omega$  in the same manner as in the case of cusp. The projections of the bifurcation set of the butterfly catastrophe to  $(a, b)$  plane for some values of parameters  $c$  and  $d$  are given in figure 16 of [A16]. The most concrete representation is in terms of the behavior of the graph of a potential as a function of control parameters for which maxima correspond to unstable and minima to stable equilibria. Catastrophes correspond in this representation transformation of real roots to complex roots or vice versa.

The model predicts that in the experiment of Godin and Roschin the system should end up to a stable situation even without load (unless the system becomes mechanically unstable). The experiments of Godin and Roschin [H47] demonstrate the slowing down of the system for the maximal critical load 7 kW (see figure 1) and from the maximal rotation velocity of 600 rpm. The interpretation is that the addition of the load reduces the value of  $\omega_{1\pm}$  to value below 600 rpm. Slowing down is caused by the fact that the stable orbit  $\omega = \omega_{1\pm}$  becomes unstable due to a fusion of the maximum  $\omega_{\pm}$  and minimum  $\omega_{1\pm}$  of the potential so that two real roots disappear and only 3 real roots remain and the system begins to slow down to the stable root  $\omega = 0$  (possibly stabilized by the load).

The condition  $\omega_{1\pm} = \omega_{\pm}$  reads as

$$\frac{1}{3} \left[ \pm \sqrt{1 + 3 \times \frac{k + k_L - a + \frac{1}{t_0}}{\omega_{cr} b}} - 1 \right] = \frac{1}{2} \left[ \pm \sqrt{1 + 4 \frac{k + k_L - a}{\omega_{cr} b}} - 1 \right] , \quad (4.3.44)$$

and allows to relate the parameter  $k_L$  characterizing the load to other parameters.

### Time evolution of the em charge of the roller

The model predicts how the electromagnetic charge of the roller evolves in time. Suppose that the outflow of the electronic charge is proportional to the overall strength of the electric field generated by the electromagnetic Faraday effect as the the assumption that a radial Ohmic current  $j = \sigma E$  is generated inside the roller. This assumption is the only one possible in single-sheeted space-time, and in TGD framework it means that the ohmic current does not flow back to the larger, non-atomic space-time sheets associated with the roller. It will be found that the assumption is unrealistic.

#### 1. Differential equations for the charge of the roller

Since the electric field generated by em Faraday effect is proportional to  $\omega$ , the general form for the differential equation governing the time development of the net em charge of the roller is

$$\frac{dQ_{em}}{dt} = a\omega(t) . \quad (4.3.45)$$

Note that  $\omega$  corresponds to the rotation velocity of the roller having maximum value of about  $230 \times 2\pi$  Hz.

One can solve this differential equation by transforming it to a differential equation with respect to  $\omega$  giving

$$\frac{dQ_{em}}{d\omega} = a\omega \times \left(\frac{d\omega}{dt}\right)^{-1} . \quad (4.3.46)$$

$a$  is dimensionless constant. At velocities much below the critical velocity, where external torque  $\tau$  dominates, one has

$$\frac{dQ_{em}}{d\omega} = aI \frac{\omega}{\tau(t)} . \quad (4.3.47)$$

For instance, for constant torque  $Q_{em}$  would increase as  $\omega^2$ . This kind of behavior is consistent with the observed accelerating growth of the weight change (proportional to  $Q_{em}$  as a function of frequency).

Above the critical velocity one can write

$$\frac{dQ_{em}}{d\omega} = a \frac{\omega}{P(\omega)} , \quad (4.3.48)$$

where one has

$$\begin{aligned} P(\omega) &= P_3(\omega) , \text{ or} \\ P(\omega) &= P_3(\omega) \left(1 - t_0 \frac{dP_3(\omega)}{d\omega}\right) \end{aligned} \quad (4.3.49)$$

depending on whether one takes into account "back reaction" or not.

### 1. Em charge for a system without "back reaction"

For the system without "back reaction" em charge remains finite:

$$\begin{aligned} Q_{em}(\omega) &= Q_{em}(\omega(0)) + \frac{a}{b} \frac{\omega_{cr}}{\sqrt{D}} \times \log \left[ \frac{(\omega - \omega_+)}{(\omega - \omega_-)} \times \frac{(\omega(0) - \omega_-)}{(\omega(0) - \omega_+)} \right] , \\ D &= \omega_+ - \omega_- = \sqrt{B^2 - 4C} . \end{aligned} \quad (4.3.50)$$

Consider first the case when the roots are real ( $D > 0$ ). For large values of  $\omega$  the charge grows with a logarithmic rate as a function of  $\omega$  and approaches to a constant value. This behavior is consistent with the observed slowing down of the weight loss above critical rotation frequency. When the roots are complex ( $D < 0$ ), one can cast the expression for the charge in the form

$$\begin{aligned} Q_{em}(\omega) &= Q_{em}(\omega(0)) + \frac{a}{b} \frac{\omega_{cr}}{\sqrt{|D|}} \times [\phi(\omega) - \phi(\omega(0))] , \\ \phi(\omega) &= 2 \times \arctan \left[ \frac{\sqrt{|D|}}{2\omega - \omega_{cr}} \right] . \end{aligned} \quad (4.3.51)$$

A analogous formula applies in the case of  $Z^0$  charge: now however  $Z^0$  electric field is of same sign for both directions of rotation and this means that the sign of the weight change is same for both directions of rotation. This excludes  $Z^0$  force as the dominant contributor to the effective change of weight.

### 3. Em charge for a system with "back reaction"

Above the critical rotation frequency the model taking into account the back reaction gives

$$\begin{aligned} \frac{dQ_{em}}{d\omega} &= \frac{a\omega_{cr}^2}{3b^2t_0} \frac{1}{(\omega - \omega_+)(\omega - \omega_-)(\omega - \omega_{1+})(\omega - \omega_{1-})} \equiv A \prod_k \frac{\omega_{cr}}{\omega - \omega_k} , \\ A &= \frac{a}{3b^2\omega_{cr}^2t_0} . \end{aligned} \quad (4.3.52)$$

Integration gives

$$Q_{em}(\omega) = Q_{em}(\omega(0)) + A \times \log \left[ \prod_k \left( \frac{\omega - \omega_k}{\omega(0) - \omega_k} \right)^{c_k} \right] ,$$

$$c_k = \prod_{l \neq k} \frac{\omega_{cr}}{\omega_k - \omega_l} . \quad (4.3.53)$$

Note that one has  $\sum_k c_k = 0$ . When the system approaches  $\omega_{1\pm}$  the value of the charge becomes infinite which is an unrealistic prediction. The prediction however suggests that the loss of effective weight could overcome gravitational force.

During the spontaneous acceleration the system should approach to constant rotation velocity  $\omega_{1\pm}$  fixed by the value of the load.  $d\omega/dt = 0$  at  $\omega_{1\pm}$  implies that  $dQ/d\omega$  is infinite and the curve representing  $\omega$  as function of  $\Delta G/G_0$  should become horizontal. This indeed holds true in a good approximation.

#### 4. Many-sheetedness is needed

The model cannot be correct as such. The failure of the model in both cases is that the predicted magnitude for the maximal charge outflow is by several orders of magnitudes higher than needed to explain the weight loss. The net rate of charging given by the difference of the radial currents at the outer and inner surfaces would be

$$\frac{dQ}{dt} = \sigma\pi [E(r_{out})r_{out}^2 - E(r_{in})r_{in}^2] = \sigma\pi\omega B [r_{out}^3 - r_{in}^3] . \quad (4.3.54)$$

The voltage over the individual roller ring due to Faraday effect is about .55 V for the maximum rotation frequency of about 230 Hz of the roller. From the estimate 460  $\mu\text{Ohm}$  for the resistance of the roller one can deduce the value of  $\sigma$  of neodymium as  $\sigma \sim 10^3 \text{ Ohm}^{-1}\text{m}^{-1}$ , the radial current would be roughly 2000 A. This current generates a net positive charge of  $10^{21}e$  per second in the roller, and means a generation of  $10^{-6}$  elementary charges per nucleon per second.

A convenient reference of comparison is provided by the ratio of  $eE/m_p g$  of the electromagnetic force caused by Earth to the gravitational force in the case of proton. For the upper bound  $E = 10^4$  V/m for the Earth's radial electric field at the surface of Earth the ratio is about  $10^{11}$  and  $10^9$  for the lower limit of  $E = 10^2$  V/m. If the em charge of the roller generated by Ohmic electron currents flowing out in the radial electric field created by Faraday effect is responsible for the change of the weight then the em charge generated per nucleon during second should be of order  $10^{-10}$ . This fraction is by a factor  $10^4$  smaller than the charge implied by the Faraday effect assuming that all Ohmic current leaks out. Many-sheeted space-time concept suggests that the charge returns back to larger space-time sheets associated with the roller so that the net charge of the roller increases much slower than in single sheeted space-time. The simplest manner to model this kind of behavior is to assume that only a fraction  $\epsilon \sim 10^{-4}$  of the Ohmic current leaks out from the system.

#### 5. The effect of 20 kV voltage

For a clockwise rotation and in the presence of 20 kV voltage with output power 7 kW the rotation frequency begins to decrease at the maximum weight loss of 35 per cent from 600 rpm. The effective weight remains constant down to 400 rpm. Without voltage this is not the case. A possible interpretation consistent with the model for the em charging is that the value of em charge becomes maximal and is not appreciably affected by the reduction of the rotation velocity reducing the vacuum electric and  $Z^0$  electric fields. This should relate somehow to the presence of the conducting copper folio around the rollers and stator carrying opposite surface charges. The presence of the folio and voltage would not allow the electrons dispersed in the environment of the rollers to readily flow back to the rollers.

The 20 kV voltage and possible accompanying  $Z^0$  voltage would take care that the rollers remain em and  $Z^0$  charged even when the radial electric fields generated by the rotation weaken. The gradual increase of the load in units of 1 kW reduces rotation speed in absence of 20 kV voltage but not appreciably in its presence.

### Estimates for the parameters of the model

The crucial question is whether the parameters that are zero in the absence of the classical  $Z^0$  force are large enough to allow the catastrophe theoretic interpretation. The following estimates demonstrate that this is the case if the rollers behave as  $Z^0$  paramagnets in the sense that the small  $Z^0$  magnetic field  $H_Z$  created by the rotational motion generates much stronger neutrino  $Z^0$  magnetization  $M_Z$ . The parameter  $\mu_Z$  defined by the condition  $B_Z = H_Z + M_Z = \mu_Z H_Z$  is of order  $10^{11}$  and this is basically due to the smallness of the neutrino mass ( $m_\nu \sim 2 \times 10^{-7} m_e$ ).

A convenient manner to characterize the situation is to compare the ratios  $\tau_i/I$ , where  $i = 1, 2, 3$  refers to the component of the torque proportional to  $\omega^i$ . Since the "back reaction" term does not dominate, it is enough to perform the estimates by neglecting its presence.

The moment of inertia of the roller with respect to the rotation axis is given by

$$\begin{aligned} I &= \rho_m \int \rho^2 dV = \frac{\pi}{2} \rho_m r_o^4 h (1 - x^4) , \\ x &= \frac{r_i}{r_o} \simeq 0 . \end{aligned} \quad (4.3.55)$$

Here  $r_o = 3.7$  cm and  $r_i = .5$  cm denote the outer and inner radii of the roller and  $h$  its height. In the following the approximation  $x \simeq 0$  is used to simplify the formulas.

Consider now various contributions to the torque.

1. The purely electromagnetic contribution to the torque corresponds to the linear term in  $\omega$  and is given by

$$\frac{\tau_{em}}{I} = \frac{\sigma}{\rho_m} B^2 \omega . \quad (4.3.56)$$

Note that the purely electromagnetic acceleration does not depend on the scale of the system.

2. The  $Z^0$  Lorentz force experienced by purely electromagnetic part of electronic Ohmic current and em Lorentz force experienced by  $Z^0$  part of electronic Ohmic current contribute torques  $\tau_{em,Z}$  and  $\tau_{Z,em}$  proportional to  $\omega^2$  in the approximation that  $Z^0$  magnetic field is proportional to  $\omega$ . The basic formulas are

$$\begin{aligned} \tau_{em,Z} &= \int (j_{em} \times B_Z) \times r dV , \\ \tau_{Z,em} &= \int (j_Z \times B) \times r dV , \\ j_{em} &= \sigma v \times B , \quad j_Z = \frac{g_Z Q_Z(e) \sigma}{e} v \times B_Z \end{aligned} \quad (4.3.57)$$

The  $Z^0$  magnetizing field  $H_Z$  is created by  $Z^0$  current

$$j_Z = n_Z \langle Q_Z \rangle g_Z v , \quad v = \omega \rho , \quad (4.3.58)$$

where  $n_Z$  is the density of average  $Z^0$  charge  $\langle Q_Z \rangle$ .  $H-Z$  can be deduced from  $\nabla \times H_Z = j_Z$ . To estimate numerically the ratios it is convenient to express  $n_Z$  as

$$n_Z = \frac{\epsilon}{a^3} ,$$

where  $a = 10^{-10}$  meters defines atomic size scale.  $\epsilon = 1$  would correspond to a  $Z^0$  charge  $\langle Q_Z \rangle$  per atomic volume.

Assuming  $Z^0$  paramagnetism this gives

$$\begin{aligned} B_Z &= \mu_Z H_Z , \\ H_Z &= n_Z \langle Q_Z \rangle g_Z \omega \frac{\rho^2}{2} . \end{aligned} \quad (4.3.59)$$

Using the approximation

$$E_Z \simeq \Omega(R + r_o) B_Z = \frac{\omega}{23} \times \mu_Z H_Z \quad (4.3.60)$$

for the  $Z^0$  electric field, one can derive the expressions for the ratios  $\tau_{em,Z}/\tau_{em}$  and  $\tau_{Z,em}/\tau_{em}$  at reference rotation frequency  $\omega_0$ , which can be taken to be  $\omega_0 = 2\pi \times 230$  Hz. This gives

$$\begin{aligned} \frac{\tau_{em,Z}(\omega_0)}{\tau_{em}(\omega_0)} &= \frac{1}{3} \times x \times X , , \\ \frac{\tau_{Z,em}(\omega_0)}{\tau_{em,Z}(\omega_0)} &= \frac{R + r_o}{r_o} \frac{6}{5 \times 23} \simeq \frac{66}{135} , \\ x &= \frac{Q_Z(e) g_Z^2}{e} , \quad X = \mu_Z \epsilon \langle Q_Z \rangle \frac{\omega_0 r_o^2}{B \alpha^3} . \end{aligned} \quad (4.3.61)$$

The power of the parameter

$$X = \frac{2B_Z(r_o)}{g_Z B}$$

characterizes the relative magnitudes of different powers of  $\omega$  in  $\tau$ .  $X$  is proportional to the parameter  $\omega_0 r_o^2$ , which suggests that the critical rotation frequency scales as

$$\omega_0 \propto \frac{1}{r_o^2}$$

in the scaling of the system whereas Larmor frequency would scale as  $1/r_o$ . This holds true if friction force is proportional to the mass of the system so that  $k \propto 1/r_o^2$  holds true.

3. The electronic  $\omega^3$  contribution  $\tau_{Z,Z}$  can be derived from the general formula

$$\begin{aligned} \tau_{Z,Z} &= \int (j_Z \times B_Z) \times r dV , \\ j_Z &= \frac{g_Z Q_Z(e) \sigma}{e} \times (v \times B_Z) . \end{aligned} \quad (4.3.62)$$

Also neutrinos could contribute to Ohmic  $Z^0$  current. The fact that the critical frequencies differ by about 10 per cent for the two rotation directions means that  $\omega^2$  term must be comparable to  $\omega^3$  term. This means that the possible contribution of neutrinos cannot be much larger than the electronic contribution.

The ratios  $\tau_{Z,Z}/\tau_{em}$  and  $\tau_{Z,Z}/\tau_{em,Z}$  are given by

$$\begin{aligned} \frac{\tau_{Z,Z}(\omega_0)}{\tau_{em}(\omega_0)} &= \frac{1}{23 \times 7} \times \frac{R + r_o}{r_o} \times x \times X^2 , \\ \frac{t_{Z,Z}(\omega_0)}{\tau_{em,Z}(\omega_0)} &= \frac{5}{7} \times X . \end{aligned} \quad (4.3.63)$$



Consider now quantitative estimates.

1. Since the parity breaking given by  $\omega^2$  term is of order 10 per cent, the order of magnitude estimate

$$X \sim 10$$

follows and gives

$$\mu_Z \epsilon \langle Q_Z \rangle \sim 10 \frac{Ba^3}{\omega_0 r_0^2} ,$$

$$B_Z(r_0) \sim 5g_Z B .$$

Not surprisingly, the induced  $Z^0$  magnetic field  $B_Z$  must be of the same order of magnitude as the ordinary magnetic field. Together with

$$x = \frac{Q_Z(e)g_Z^2}{e} \simeq 10^{-2}$$

this means that third order term is of order ten per cent from the linear term when the "back reaction" is not taken into account.

2. For  $\mu_Z = 1$  the requirement  $X \sim 10$  would give  $\epsilon \sim 10^{-3}$ . This is certainly an unrealistic value of  $Z^0$  charge density since even very small strengths of the Earth's  $Z^0$  electric field would give to large changes of effective weight. The theory of paramagnetism generalizes in a straightforward manner to the case of  $Z^0$  paramagnetism due to the unpaired neutrino spins.  $Z^0$  magnetization density and  $\mu_Z$  in the thermal equilibrium are given by

$$\begin{aligned} M_Z &= n_\nu \tanh\left(\frac{\mu_{\nu,Z} H_Z}{T}\right) \times \mu_{\nu,Z} \simeq n_\nu \times \frac{\mu_{\nu,Z} H_Z}{T} \times \mu_{\nu,Z} , \\ \mu_Z &\simeq n_\nu \times \frac{\mu_{\nu,Z}}{T} \times \mu_{\nu,Z} , \\ \mu_{\nu,Z} &= \frac{g_Z Q_Z(\nu)}{2m_\nu} . \end{aligned} \quad (4.3.64)$$

The linear approximation holds true for  $\mu_{\nu,Z} H_Z Z/T \ll 1$ . From the previous estimate on has  $B_Z \sim B$ , which gives  $\mu_{\nu,Z} H_Z/T \sim 10^{-3}$  at the room temperature.  $n_\nu$  denotes the density of unpaired neutrino spins: the first guess is that there is roughly one unpaired neutrino spin per atomic volume. This would give  $\mu_Z \sim 10^{11}$  and  $\epsilon = 10^{-13}$ . The estimate looks rather reasonable and the presence of unpaired neutrino spins might relate to the  $Z^0$  charging of the rollers.

### The condition that $Z^0$ charge can cause appreciable effects

One can also estimate also the amount of  $Z^0$  charge needed to generate a weight change comparable to the electromagnetic weight change. One can deduce an expression for the  $Z^0$  charge per nucleon (neutron or proton) by expressing the total mass as  $m_0 = Nm_p$ :

$$\frac{Q_Z}{N} = Q_Z(p) \frac{\Delta G}{G_0} \frac{m_p g}{g_Z Q_Z(p) E_Z} . \quad (4.3.65)$$

At the right side appears the ratio of the gravitational force to classical  $Z^0$  force experienced by proton.

A reasonable looking lower bound for  $Q_Z$  follows from the requirement that the  $Z^0$  electric force experienced by proton in the Earth's magnetic field is not stronger than the electric force so that one would have the constraint

$$\frac{g_Z Q_Z(p) E_Z}{m_p g} < 10^{11} .$$

The proton's  $Z^0$  charge is  $Q_Z(p) \sim 1/50$ . From this a lower bound for the  $Z^0$  charge per nucleon follows

$$\frac{Q_Z(f_{cr})}{N} = \frac{\Delta G_{cr}}{G_0} \frac{m_p g}{g_Z E_Z} > .30 \times 5 \times 10^{-10} = 1.5 \times 10^{-10} . \quad (4.3.66)$$

Roughly every tenth billionth neutron would be unscreened. The result seems rather reasonable.

To my best knowledge in the construction of Searl the rollers were not constrained in any manner to the system. The requirement that the centrifugal acceleration does not throw the rollers away gives an additional constraint to the theory. Em force or directed radially inwards could explain the stability. The stability condition reads as  $mv^2/R \leq QvB$  and gives

$$\frac{Q}{N} \geq \frac{m_p f}{2\pi B} . \quad (4.3.67)$$

For  $B = 1$  Tesla and  $f = 10$  Hz this gives  $Q/N \geq 5.6 \times 10^{-11}$ . A possible interpretation for the plasma around the rotor is as electrons flown out of the rollers.

### Explanation of the coronal discharge

The presence of the coronal discharge with the characteristic ozone smell around the rotor in the experiments of Roshchin and Godin [H49] has pink-blue color. This suggests that the light results from atomic or molecular transitions. Gas discharge tubes and so called sprites and elves associated with certain type of lightnings exhibit also red and blue light (see [F7] and TGD based model of this phenomenon in [K59]). In the case of sprites red and blue light results from the electronic excitations of  $N_2$  molecules and blue light from the collisions of electrons or  $N_2$  molecules exciting  $N_2^+$  ions. Similar mechanism could be at work also now.  $N_2$  molecules and  $N_2^+$  ions would be ions of the surrounding air and one should understand the origin of electrons.

Unfortunately, it is quite not completely clear from [H47] whether the luminescence was present only when 20 kV voltage was present. In this case one could understand the phenomenon as a dielectric breakdown. In the case that the luminescence was present also in the absence of 20 kV potential the explanation of the phenomenon should relate to the outflow of electrons from the rollers as Ohmic currents.

One can imagine several candidates for the explanation of this phenomenon and the situation is still somewhat unsettled.

1. The first and wrong guess is that the acceleration of charged particles in the radial electric field generated by the rotation alone gives them enough energy so that they can ionize the air. The energy gained by an electron moving freely in the radial electric field is  $\Delta E = eB\omega\rho^2/2$ . For  $B = 1$  Tesla,  $\rho = .1$  meters and  $\omega = 20\pi/s$  this gives energy which is about .6 eV, which cannot cause ionization. When friction is taken into account, the estimate for the average kinetic energy gained between two successive collisions is  $\Delta E = eEl$ , where  $l = 1/n\sigma$  is the free path of the charged particle in the magnet. From the estimates  $\sigma \sim 10^{-20} m^2$  (geometric cross section for atom),  $n_0 = 10^{30}/m^3$  for the order of magnitude of the density of the condensed matter, it is clear that the energy is quite too low to cause ionization.
2. The leakage of the electrons of the Ohmic current to the space-time sheets of environment involves dropping from atomic space-time sheets to larger space-time sheets. In this process they would liberate their zero point kinetic energy. This process would also occur only during the rapid acceleration. For an electron the dropping from the atomic space-time sheet this energy is about 1 keV so that X rays are liberated. These X rays would ionize the air and generate highly energetic electrons, which in turn make collisions with  $N_2$  molecules and  $N_2^+$  ions and generate electronic excitations producing the pink-blue glow. For ions the zero point

kinetic energies are below .5 eV (proton's zero point kinetic energy). This process is indeed expected to occur near the boundaries of the rolling magnets.

This process allows also the following interpretation. The time reversal involves phase conjugates of microwaves and perhaps also radiation at other wavelengths. Phase conjugate waves correspond to photons with negative energy. Therefore one might see the emission of X ray as a process in which negative energy X ray is emitted from the region containing the luminous plasma and absorbed by the electron dropping to the larger space-time sheet. The time reversed process could start already from the excitation of the molecules of air by the emission of negative energy photons and end with the emission of negative energy X ray inducing the dropping of the ion to the magnetic flux tube. This picture would conform with the claimed absorption of energy from the environment in the rotating magnetic system and the decrease of entropy. TGD indeed predicts that the second law of thermodynamics holds true only above p-adic time scale characterizing the system and that below p-adic time scale the arrow of the geometric time can change (that p-adic numbers are not well ordered conforms with this). Even the spontaneous acceleration of the rolling magnets could be interpreted as a dissipative slowing down in an appropriate time scale.

In many-sheeted space-time particles topologically condense at all space-time sheets having projection to given region of space-time so that this option makes sense only near the boundaries of space-time sheet of a given system. Also p-adic phase transition increasing the size of the space-time sheet could take place and the liberated energy would correspond to the reduction of zero point kinetic energy. Particles could be transferred from a portion of magnetic flux tube portion to another one with different value of magnetic field and possibly also of Planck constant  $h_{eff}$  so that cyclotron energy would be liberated. In the following only the "dropping" option is discussed.

3. Godin and Roschin [H47] compare the phenomenon to a high voltage microwave induced dielectric breakdown. The transversal electric fields associated with the topological light rays serving as correlates for the negative energy microwave photons emitted by the magnetostatic wave pattern could define the high voltage making possible the acceleration of electrons to kilovolt energy range so that they can ionize the surrounding air. The appearance of yellowish-white luminescent bands with distance of about roller radius 3.7 cm along the height of the roller surface have been reported and might relate to the dependence of the magnetostatic wave patterns on the vertical coordinate. The variation might relate to the local variation of the magnetostatic resonance frequency caused by the non-isotropic character of the magnetization in the vertical direction in turn causing the variation of dominant microwave frequency and the associated transversal voltage.

### Critical question: Could Lorentz torque serve only as a control mechanism?

Year of two after the construction of the model above I learned that the Lorentz torque might serve as a relatively weak control action only. The point is that the magnetic field of the stator rotates with that of rollers and the fact that the magnetic flux in the rollers could correspond to the return flux of the stator magnetic field suggests this. In this kind of situation a radial current is established also in the stator. The radial ohmic currents in the stator and rollers are directed inwards/outwards or vice versa in this kind of situation so that the radial current from stator can flow to rollers. A flow equilibrium could result providing rollers and stator with opposite charges.

Lorentz torque forces the electrons to a rotational motion in both stator and rollers. If the distributions of the electronic charge density is not fully rotationally symmetric this implies an electrostatic torque which could force the rollers to a rotational motion. In this kind of situation Lorentz force would serve in the role of control knob inducing much stronger torque. The catastrophe theoretic model discussed above could still serve as a satisfactory model for the situation although originally constructed assuming that only roller magnetic fields rotate. Later a detailed model for the flow equilibrium is discussed allowing to gain some insights about the significance of the material composition of the system.

#### 4.3.4 The role of the material composition of the system

The proposed model is certainly far from a complete description.

1. The description does not distinguish between Searl device and a much simpler rotating cylindrical magnet.
2. No consideration is given to the materials used in the device.
3. It has been also assumed that the radial ohmic current flows freely in and out from the roller. This need not be the case so that only a polarization implying no effective weight loss could occur.

The elegant experiments carried out by Samuli Penttinen (personal communications) with simpler systems involving essentially rotating cylindrical magnets has given important clues about the additional features that might be essential for the functioning of the Searl device and its modifications. Samuli also realized that the nylon layers used in the rotating magnets could serve as charge reservoirs and this could be important for the functioning of the system.

#### **Polarization viz. net charging**

The experiments with rotating magnets demonstrated that the weight loss does not occur in systems involving only single rotating magnet or several of them on top of each other. This can be understood if the system only polarizes: the radial ohmic current would gradually generate constant charge density inside the system and a compensating surface charges at the outer (and possible inner) surfaces of the rotating magnet (say cylindrical shell). What is required is net charging and flow equilibrium in which di-electric breakdown (indicated by the ozone smell) occurs continually.

#### **Material composition of the system**

Both the stator and rollers have a four-layered Titanium-iron-nylon-neodymium structure (titanium being the outermost layer) in the device of Russians. Both iron and titanium are magnetic materials and good conductors. It is however not clear why just iron and titanium should be used besides neodymium and nylon.

Consider next the possible function of the nylon layer which does not carry magnetic field.

1. Cylindrical layers made of nylon are known to be capable of developing very high polarization charges in an external electric field. Also high friction charges are generated in structures consisting of nylon.
2. Cylindrical nylon layers start to rotate if the electric field is created by oppositely charged charge-carrying structures parallel to plane orthogonal to the axis of the cylinder and at opposite sides of the cylinder and not tangential to the cylinder. The rotation is due to the net torque generated by the Coulomb interaction between induced charges and the opposite charges carried by the structures is non-vanishing. In the device of Godin and Roschin it is difficult to imagine that torque could be generated by electrostatic forces.
3. Searl believed that nylon layer serves as a kind of control gate guaranteeing continual flow of electric charge in radial direction from neodymium magnet instead of a pulsed flow. Pulsed flow might be interpreted in terms of a generation of high polarization surface charge followed by a dielectric breakdown reducing the charge to a small value after which it takes time to get back to the criticality. In flow equilibrium nylon layer would receive the radial ohmic current from neodymium and transfer it to iron. By its properties nylon could serve as a high capacity charge reservoir so that the dielectric breakdown at the surface of the roller would not lead to a dramatic reduction of the net charge and a continual criticality could be achieved.

4. Nylon is an organic material and one cannot exclude the possibility that this might be crucial for the functioning of the device. For instance, plasmoids are generated in microwave oven if one burns organic material such as match in the oven. It might be just the organic character of nylon which allows dropping of electrons to larger space-time sheets in the di-electric breakdown.

### Quantum criticality

It is known that the experiments are difficult to replicate. A possible explanation is that the phenomenon is quantum critical and occurs in a narrow range of physical parameters. Quantum criticality would most naturally correspond to a criticality against dielectric breakdown involving dropping of electrons to the larger space-time sheets making possible over unity energy production. The radial ohmic current and net positive charge stabilized by nylon layer would guarantee that this situation prevails. Critical fluctuations have typically a coherence length and the generation of magnetic walls could be interpreted as critical fluctuations.

### Model for flow equilibrium

In order to get a quantitative picture it is good to examine explicitly what happens in flow equilibrium.

#### 1. The conditions characterizing flow equilibrium

Assume that layers contain rotating magnetic field. As will be found, this does not necessarily require that the layer rotates. In flow equilibrium current from layer below equals to the current to layer above so that one has the conditions

$$j_{air,-} = j_{Ti,+} \quad j_{Ti,-} = j_{Fe,+} \quad j_{Fe,-} = j_{nylon,+} \quad j_{nylon,-} = j_{neod,+} \quad . \quad (4.3.68)$$

Here the subscript  $+/-$  refers to the outer/inner boundary of the layer.

#### 2. Charges in the interiors of layers and corresponding electric fields

The values of the charges generated inside the layers and the surface charges at their boundaries can be deduced from flow equilibrium conditions.

1. In equilibrium the electric field inside given layer is the sum of the rotationally generated component  $E_{Fara} = \omega\rho \times B$  and the static component  $E_{stat} = \lambda_{below}/\rho$  generated by the net charge in the layers below:

$$E = E_{stat} + E_{Fara} \quad . \quad (4.3.69)$$

The net static electric field due to the positive charge density generated by Faraday effect is always outwards directed and does not depend on the direction of rotation unlike the direction of  $E_{Fara}$ .

2. The positive charge per unit length in the interior is given by

$$\lambda(t) = \int \nabla \cdot j_{Ohm} = 2\sigma_{layer} S_{layer} B \int \omega(t) dt \quad , \quad (4.3.70)$$

where  $S(layer)$  is the area of the layer. For the net field  $\sigma_{layer} S_{layer}$  is replaced by sum over the contributions of layers below it.

The static electric field created by a given layer is

$$E_{stat} = \frac{2}{\epsilon_0} \sigma_{layer} S_{layer} \times \frac{2B \int \omega dt}{\rho} \quad . \quad (4.3.71)$$

The charge and the field increases without limit in absence of dielectric breakdowns. Note that the ratios of static electric fields are given by the ratios of quantities  $\sigma_{layer}S_{layer}$  of various layers. From the table below it is clear that iron neodymium) layer contains the highest (lowest) charge and generates the strongest (weakest) field.

This formula dictates the charges of the magnetic layers but says nothing about the charge of the nylon layer expected to act as a charge reservoir. Assuming that nylon layer contains a constant charge density, the situation is mathematically similar to that for magnetic layers but the prediction of the value of charge density in flow equilibrium would require a model predicting the maximal charge stored by the nylon layer.

### 3. Charges at the boundaries of layers

In flow equilibrium the ohmic current flowing from layer below equals to the ohmic current entering to the layer above. This gives

$$E_{above,-} = \frac{\sigma_{below}}{\sigma_{above}} E_{below,+} . \quad (4.3.72)$$

The subscript  $+/-$  refers to the top/bottom of the layer.

The difference of the normal components of electric fields determines the density of the surface charge  $\rho_s$  accumulating at the boundary between the layers

$$\rho_s = \rho_s = \frac{E_{above,-} - E_{below,+}}{\epsilon_0} = \frac{\sigma_{below}}{\sigma_{above}} \frac{E_{below}}{\epsilon_0} . \quad (4.3.73)$$

The ratio of fields  $E_+$  and  $E_-$  in a given layer is given by

$$\begin{aligned} \frac{E_+}{E_-} &= \frac{E_{stat,+} + E_{Fara,+}}{E_{stat,-} + E_{Fara,-}} \\ &= \frac{E_{stat,-} \frac{R_-}{R_+} + E_{Fara,-} \frac{R_+}{R_-}}{E_{stat,-} + E_{Fara,-}} . \end{aligned} \quad (4.3.74)$$

At the limit when the static charge of the layer is very large  $E_{Fara}$  can be neglected and one has

$$\frac{E_-}{E_+} \simeq \frac{R_+}{R_-} . \quad (4.3.75)$$

Integer ratios are obtained in the layered geometries considered.

### 4. Concrete application of the boundary conditions

These general conditions can be applied to deduce what happens in the flow equilibrium.

1. The conductivities of neodymium, nylon, iron, and titanium are given by the table below

material	neodymium	nylon	iron	titanium	air
$\sigma/10^{-6}\Omega m$	1.6	$(.1 - 5) \times 10^{-6}$	10	2.4	$1.5 \times 10^{-8}$

2. In the flow equilibrium an electric field at neodymium-nylon boundary at radius  $\rho = R_1$  satisfies the condition  $E_{nylon,-}/E_{neod,+} = \sigma_{neod}/\sigma_{nylon}$ , which is in the range  $(0.32-16) \times 10^6$  so that the boundary layer contains very strong positive surface charge amplifying the net positive charge of the neodymium layer.

3. In nylon the ohmic radial current is conserved so that the static electric field in nylon decreases as  $1/\rho$ . Hence in nylon-iron layer at radius  $R_2$  one has

$$\frac{E_{iron,-}}{E_{nylon,+}} = \frac{\sigma_{nylon}}{\sigma_{iron}} , \quad (4.3.76)$$

which is in the range  $(.1 - 5) \times 10^{-7}$  so that a negative surface charge is generated at this layer whose magnitude is by a factor

$$\frac{\sigma_{neod} R_2}{\sigma_{iron} R_1} \quad (4.3.77)$$

larger than the positive surface charge in layer below.  $E_{iron,-}$  can be expressed in terms of  $E_{neod,+}$ .

$$E_{iron,-} = \frac{\sigma_{neod} R_1}{\sigma_{iron} R_2} E_{neod,+} . \quad (4.3.78)$$

Obviously nylon layer is strongly polarized and carries very strong electric field.

4. In titanium-iron boundary one obtains

$$\begin{aligned} E_{Ti,-} &= \frac{\sigma_{iron}}{\sigma_{Ti}} E_{iron,+} \text{ since } 4.3 E_{iron,+} = \frac{\sigma_{iron} R_1}{\sigma_{Ti} R_2} E_{iron,-} \\ &= \frac{\sigma_{neod} R_1}{\sigma_{Ti} R_2} E_{neod,+} \end{aligned} \quad (4.3.79)$$

so that a positive charge density is generated. The ohmic current from iron is by a factor larger about 4.3 than the ohmic current entering to titanium so that a negative charge density should indeed accumulate at the iron-titanium boundary layer.

5. In titanium-air boundary the application of the continuity conditions together with the fact that the conductivity of air is about  $1.5 \times 10^{-8} / \text{Ohmm}$  implies that the electric field in air is by a factor of order  $10^8$  stronger than in titanium layer so that a very strong positive surface charge should be generated. This positive surface charge might relate to the ionization of air caused by the electron current by the proposed mechanism. Thus it would seem that the most important boundary is titanium-air boundary.

Of course, the application of the conditions in this boundary layer might be too strong an idealization since the following estimate suggests that dielectric breakdown occurs. The Faraday field  $E = vB = 2\pi fBR$  at the surface of the system containing rotating magnetic field has for  $f = 10$  Hz,  $R = .1$  m,  $B = 1$  Tesla, the magnitude  $2\pi$  V/m. This would mean that the electric field in air would be  $2\pi \times 10^5$  kV/m. The electric field needed for the dielectric breakdown in air is  $E \sim 3 \times 10^3$  kV/m so that the breakdown should occur for the roller system much before the maximum field strength is achieved and the proper description should be based on the notion of continual di-electric breakdown.

### Two views about the functioning of the system

The magnetic fields in stator and rollers are in opposite direction. Thus the magnetic flux tubes from the stator should return back along rollers and the flux quanta associated with layers made of particular element could correspond to each other. In this kind of situation one might think that the rotation of the magnetic fields associated with the rollers forces also the magnetic field of the stator to rotate. Otherwise a twisting of the magnetic flux tubes analogous to that occurring at the convection zone of Sun occurs and a periodic process analogous to the formation of sunspots should occur as flux tubes eventually untwist.

The problem is that if the magnetic field of the roller rotates both with respect to stator- and roller axis, a twisting around roller axis still occurs. The only way out seems to be the assumption that the magnetic field associated with the roller resides at two space-time sheets.

1. The first magnetic component rotates only with respect to the stator axis and corresponds to the return flux of the stator.
2. Second component rotates with respect to the roller axis and its return flux flows along the magnetic walls and one would have also an explanation for the appearance of the magnetic walls as a return flux of a magnetic field created by dropped electrons possessing angular momentum. The electrons from the surface of the stator at almost-contact points with the rollers (at least here) would drop to the magnetic flux tubes carrying the magnetic field rotating with the roller. Hence the formation of magnetic walls would be forced by the dropping process. The first guess would be that the gradual buildup of the walls could mean that the part of the return flux of rollers flowing through stator transforms gradually to a return flux through walls and thus minimizes the losses due to the eddy currents generated by the rotation of the return flux of rollers through stator. The return flux is however parallel to that in rollers so that the guess is wrong.

There are thus two options depending on whether stator magnetic field rotates or not.

#### 1. *Magnetic field in the stator does not rotate*

Assume first that the magnetic field in the stator does not rotate.

1. Rotating magnetic layers develop a constant density of positive interior charge with a constant rate  $d\rho/dt = \sigma\omega B$  by the radial ohmic current. This charge is compensated by a negative surface charge gradually cumulating to the surface of the magnetic layer unless the radial current flows to the nylon layer as in the case of Neodymium. The iron layer above the nylon layer can suck electrons from nylon.
2. The negative charge at the outer surface of a rotating roller induces an opposite polarization charge at the stator surface in the immediate vicinity of the rotating roller. A flow of electrons to the stator can occur in the resulting strong electric field so that the stator develops a negative net charge and roller a positive net charge. The charge flow between roller and stator could involve a dielectric breakdown with dropped electrons at the large space-time sheet carrying the current.
3. Stator-roller polarization does not yet lead to the effective weight loss in the Earth's electric field. This is achieved if di-electric breakdown starts to occur along the entire roller surface and induces a net charging of the stator-roller system and a negative ionization of the air. Di-electric breakdown would start to occur as the roller develops a critical positive charge. Nylon layer would guarantee that a dielectric breakdown occurs continually at the entire roller surface and the charge of the roller would have a constant value in the flow equilibrium.

#### 2. *Magnetic field in the stator rotates*

If the magnetic field of the stator co-rotates, a radial current is generated also in the stator and the previous general picture applies to it. The overall radial scale of the stator is larger so that the charging rates for the magnetic layers in the stator would be higher since the areas of layers are larger. Note that the flow equilibrium at the inner surface of the stator (air-Nd boundary) would



also give also non-trivial condition. An alternative option would be that a positive surface charge is generated at the inner surface.

There would be two different radial currents if magnetic field has two components at separate space-time sheets. The radial current associated with a space-time sheet rotating with stator would flow inside rollers in the radial direction with respect to rollers apart from a rotation induced by Lorentz force. The radial electronic current flowing at the space-time sheet rotating with the stator would flow inwards and would consist of dropped electrons.

These currents make possible the generation of opposite charges for the roller and stator system and electrostatic forces could guarantee the stability of the rotation of rollers against centrifugal acceleration. In fact, a very rough order of magnitude estimate for the magnetic and centripetal forces demonstrates that the orders of magnitude for the magnetic and kinetic energies of the roller should be same. Magnetic energy is however smaller by several orders of magnitude for reasonable parameter values.

Electrostatic force could induce a torque if the rotational symmetry is broken.

1. The Lorentz torque on the radial ohmic currents causes the rotation of the radial electrons around the stator and rollers in the same direction and could serve in the role of a switch inducing possibly much stronger electrostatic torque.
2. The flow of the electronic charge from the stator to roller at almost-contact points and stator-roller electrostatic interaction would induce a breaking of the rotational symmetry for the rotating charge distributions.
3. One can imagine a situation in which the roller and its electronic charge distribution rotate with the same velocity as the rotationally non-symmetric charge distribution in the stator so that the distribution of Coulomb forces and torques between charge distributions does not change and net force and torque vanish in equilibrium. The deviations from equilibrium by acceleration or slowing down would generate torque.
4. It must be however emphasized that this situation is purely classical. Rotation continues as long as one feeds rotational energy to the system to compensate for the dissipative effects. The spontaneous acceleration of the system is something very different and its energetics requires new physics.
5. In flow equilibrium there must be an electron flow from the hollow air volume inside the stator to the air volumes inside rollers and the expectation is that a closed current circuit is formed in the flow equilibrium. This mechanism would guarantee that the positive charges associated with various magnetic layers do not grow without limit. The system however loses electrons as they drop to the space-time sheet carrying the magnetic flux rotating with respect to the roller axis if the system accelerates spontaneously and the system develops a positive "visible" charge: this charge cannot grow indefinitely. One might hope that the diffusion of electrons from air could compensate for the losses so that the system could effectively act as a perpetuum mobile for some time.

### More precise view about the dropping of electrons

The notion of many-sheeted space-time gets quite strong empirical support from the recent findings that nuclear reaction rates depend on the electronic environment and are highest in conductors [C16, C15]. The formula explaining the enhancement of the reaction rates is based on the idea that projectile nucleus is accelerated in the Coulomb field of the electronic plasma cloud surrounding the nucleus and causing Debye screening [C25, C34]. The model is however in a direct conflict with atomic physics which does not allow the description of atomic electrons below atomic radius using classical thermodynamics.

TGD reproduces the empirically verified formula for the enhancement of the reaction rates by assuming a variant of Trojan horse mechanism according to which the projectile nucleus arrives the target nucleus along a space-time sheet associated with conduction electrons and in this manner overcomes Coulomb barrier [K71]. The assumption that thermal excitations kick the projectile nucleus to the space-time sheet of the conduction electrons produces same formulas as Debye model.

There is no need to ad hoc "de-quantization" of atomic physics although one must generalize it to many-sheeted space-time.

This model gives also highly welcome constraints to the model for how electrons are dropped to larger space-time sheets in rotating magnetic systems.

1. The assumption that the conduction electrons drop from "conduction space-time sheets" would explain why the magnets used must be conductors. It would however force to challenge the simple model which assumes that electrons are essentially free. The problem is that Coulombic binding energy with nuclei dominates over the kinetic energy for conduction bands. This means that in the dropping to the space-time sheet of the environment at which Coulomb interaction energy is absent, the energy of the electron would increase so that the process would require energy!
2. The most obvious resolution of the problem would be that the radial electronic current does not correspond to electrons in the ordinary conduction band but to free electrons not feeling the Coulomb attraction of the nuclei. The size of the space-time sheets in question should be atomic, that is correspond to the p-adic length scale  $L(k = 137) \simeq .8$  Angstrom. Note that these sheets would be connected by thin join along boundaries bonds to a larger connected structure to make possible the flow of the current. The first thing to come in mind is that This structure directly corresponds to the atomic lattice.

This makes sense if the atomic nuclei feed their electric gauge fluxes to space-time sheets smaller than atomic space-time sheets. The Bohr radius for  $n = 3$  electron orbital for Fe with  $Z = 26$  is  $n^2 a_0 / Z \sim .18$  Angstroms to be compared with the p-adic length scale  $L(k = 131) \simeq .1$  Angstrom, so that  $L(131)$  is the natural guess for the p-adic length scale associated with bound electrons. For instance, bound atomic electrons could reside at  $k = 131$  space-time sheet, conduction electrons at  $k = 134 = 2 \times 67$  space time sheet ( $p = 67$  is prime), and free electrons of the radial ohmic current at  $k = 137$  space-time sheets receiving no electric gauge flux (electronic and nuclear fluxes compensate each other in this length scale precisely).

This picture leads to an additional condition for the model: the material used must be such that free electrons are possible at  $k = 137$  space-time sheets. It also predicts that Searl device ceases to work when the free electrons have been depleted from atomic space-time sheets.

### 4.3.5 Magnetic fields associated with the Searl device

The magnetic fields associated with the Searl device are highly interesting. The topological quantization of the rotating magnetic and  $Z^0$  magnetic fields might have interesting effects. The magnetic walls are not identifiable in terms of the return flux of the magnetic field of stator+roller system and their proper interpretation should be decisive for the understanding of the functioning of the system.

#### Magnetic fields generated by the rotating system

The magnetic field associated with the rollers rotates. Also the Earth's magnetic field is associated with a rotating system. Magnetosphere decomposes into a rotating inner magnetosphere and non-rotating outer magnetosphere. The ionic current due to the ions frozen to the magnetic flux tubes is a signature for whether the magnetic field is rotating and means in case of the inner magnetosphere the presence of ring currents. The radial electric field  $E = v \times B$  is in the case of the Earth's magnetosphere of order .02 V/m and much weaker than the radial electric field of about  $10^2 - 10^4$  V/cm.

This raises the question whether the rotating magnetic and  $Z^0$  magnetic fields associated with the Searl's machine decomposes into a rotating inner magnetosphere consisting of flux tubes and the non-rotating outer magnetosphere consisting of magnetic walls. As discussed in the Appendix, the  $DCP_2 \rightarrow 3$  phase transition in which the dimension of the  $CP_2$  projection of the space-time sheets carrying magnetic field increases two to three, implies a qualitative change in the structure of the magnetic field, and might also relate to the generation of the magnetic walls.

In many-sheeted space-time it is not obvious that the magnetic fields of rollers and stator sum up coherently inside the rollers and stator. The generation of magnetostatic waves requires coherent summation and it seems natural to assume that coherent summation occurs inside stator. For rollers coherent summation is not consistent with the idea that rotation corresponds to the rotation of the vector potential defining the magnetic field.

### What is the interpretation of the magnetic walls?

As already discussed, the experiments of Godin and Roschin involve also strange magnetic walls and accompanying thermal effects begin to appear at about  $f = 200$  rpm at which also the effective weight change becomes detectable. The thickness of walls is about 5 cm and the distance between the walls is about .5 m which corresponds to the outer radius of the stator ring. The height of the walls is at least 12 m and the field intensity stays essentially constant up to 15 m and then weakens rapidly. The maximum value for the magnetic field strength is .05 Tesla at  $f = f_{cr} = 600$  Hz. The direction of the magnetic field inside the magnetic walls is upwards. Since the stator magnetic field is directed downwards and its flux dominates over the flux of the roller fields, one could interpret magnetic walls in terms of the return flux of a topologically quantized dipole magnetic field created by the stator-rotor system.

The following observations are crucial hints concerning the formulation of the quantum level model for the spontaneous acceleration of the rollers.

1. For electron possessing only spin angular momentum the Larmor frequency  $\omega_L = g e B / 2 m_e$ ,  $g \simeq 2$ , associated with a magnetic field of 1 Tesla field corresponds to a wavelength of 2.5 cm, one half of the thickness of the magnetic walls. What looks mysterious is why the thickness of magnetic walls should be twice the Larmor wavelength.
2. The Larmor frequency for the maximal .05 Tesla magnetic field associated with walls corresponds to .6 GHz and wavelength of .5 meters, the radius of the stator. This strongly suggests that some kind of resonance mechanism is involved.

In TGD framework the strange magnetic field structures are identifiable as topological field quanta of the magnetic field somehow generated by the rotating magnetic system. Magnetic walls are present only in the rotating system so that they cannot be solely due to the dipole fields of a non-rotating system.

1. The first identification would be magnetic fields resulting in a spontaneous magnetization of a Bose-Einstein condensate of Cooper pairs of electrons associated with the space-time sheets of the magnetic walls.
2. An alternative identification would be as the flux quanta of both  $Z^0$  and em magnetic fields associated with the rolling cylinders. For vacuum extremals  $Z^0$  field is approximately 8 times stronger than magnetic field and of opposite sign. This would suggest that the return flux of topologically quantized  $Z^0$  magnetic field created by the rotating rollers is in question. The predicted maximal value of  $Z^0$  magnetic field would be about .4 Tesla for vacuum extremals.

One can discriminate between the two proposals by using the fact that the temperature is lower inside magnetic walls.

1. For vacuum extremals the magnetic energy density vanishes inside magnetic walls so that no temperature change should occur. Hence the identification in terms of  $Z^0$ -em magnetic walls does not seem to work.
2. One could try to understand the lowering of the temperature inside the magnetic flux structures in the following manner. In ordinary hydrodynamics the condition  $p + \rho v^2 / 2 = p_0$ , where  $p_0$  is pressure in the region where flow velocity vanishes, holds true by energy conservation along flow lines. In magneto-hydrostatics the corresponding condition reads as

$$p + \frac{B^2}{2} = p_0 = nT_0, \quad (\hbar = c = 1) . \quad (4.3.80)$$

Here  $p_0$  and  $T_0$  denote the pressure and temperature outside the magnetic flux tubes and the equation  $p = nT$  for ideal gas has been used. The equation implies a lowering of the temperature:

$$\frac{\Delta T}{T} = -\frac{B^2}{2p_0} .$$

For a magnetic field strength of order .05 Tesla and pressure of one atmosphere ( $10^5 \text{ N/m}^2$ ) the estimate for the reduction is  $\Delta T/T \simeq 10^{-2}$ , which is one half of the reported reduction of temperature  $\Delta T/T \simeq 6 \text{ K}/295 \text{ K} = .02$ . The failure by a factor of two might signal the transfer of thermal energy to the roller system. For spontaneous magnetization the density of magnetic energy need not be even positive so that the thermal energy would be completely transferred to the rotating system. In any case, the order of magnitude is sensible and does not favor the presence of  $Z^0$  magnetic field.

### 4.3.6 Remote energy and angular momentum transfer in rotating magnetic systems

The classical model for the spontaneous acceleration does not explain how the Lorentz torque on electron current is transformed to a torque on rollers. Neither does it explain the origin of the magnetic energy of magnetic walls.

#### What should one understand?

The mechanism forcing the rotor magnets to roll without slipping is easy to understand. As mentioned already earlier, the periodic deviation of the direction of magnetization from vertical with the same period for the rollers and stator makes the magnets magnetic cogwheels. This guarantees that the rollers roll rather than only rotate since the resulting magnetic torque makes slipping impossible.

The energetics behind the formation of magnetic walls and spontaneous acceleration is however far from clear. Also the generation of angular momentum of the roller should be understood.

1. The formation of magnetic walls requires energy and also the possible Bose-Einstein condensates in possible excited cyclotron energy states require also energy and one should understand the origin of this energy.
2. The proposed classical model for the spontaneous acceleration does not say anything about the detailed mechanisms for how the torque on ohmic current is transformed to a torque on the roller. If the oppositely directed magnetic fields of the stator and roller rotate in the same direction, the flow of electrons from stator to rollers at almost-contact points could break the rotational symmetry and Lorentz torque could serve as a switch inducing electrostatic torque vanishing when rollers rotate with same velocity as charge distributions in dynamical equilibrium. This model explains the rotation of the rollers if one feeds to the system rotational energy compensating for dissipative losses but does not say anything about spontaneously occurring acceleration which requires a mechanism generating an additional torque.
3. Remote metabolism or remote utilization of energy by sending negative energy phase conjugate photons to a suitable target able to absorb them is basic mechanism in TGD inspired theory of consciousness and of quantum biology and could be at work now. This mechanism could also make possible remote transfer of angular momentum.

#### How the Lorentz torque on ohmic current is transformed to a torque on the roller?

The proposed classical mechanism assumes that the Lorentz torque on the ohmic current is somehow transformed to a torque on the roller. The classical realization would be by the symmetry breaking mechanism already discussed leading to a situation in which rollers rotate with a constant velocity if rotational energy is feeded to compensate for the dissipative effects. For quantum level mechanism leading to the spontaneous acceleration the transfer of the electronic angular momentum to the roller would most naturally occur as the conduction electrons with net angular

momentum drop to a larger space-time sheet and give their angular momentum to the roller. If the dropping is radiationless meaning that the liberated zero point kinetic energy is received by the roller, the mechanism also provides the energy needed by the accelerating motion of the roller.

The mechanism would be analogous to the mechanism in which scattered lattice electron gives part of its momentum and energy to the lattice. The first guess is that the liberated photon with energy  $E \leq E_{max} = .94$  keV is absorbed by a titanium atom in the roller. If the electron drops from  $k = 137$  to  $k = 139$  the liberated zero point kinetic energy is from the proportionality  $E_0 \propto 1/L(k)^2 \propto 2^{-k}$  given by  $3E_{max}/4 \simeq .705$  eV. The nuclear charge of Ti is  $Z = 22$  and electronic configuration is  $3d^24s^2$ . The binding energy is for the ground state  $E(Ti, 1) \simeq 22^2 E_H = 6.5824$  keV and for  $n = 3$  state  $E(Ti, 3) \simeq E_{Ti}(1)/9 = .731$  keV, which is rather near to the zero point kinetic energy liberated in the dropping of conduction electron from  $k = 137$  to  $k = 139$  space-time sheet.

For Fe one has  $Z = 26$  and the ionization energy from  $n = 3$  state is 1.021 keV in the same approximation so that also iron could be considered as the outermost layer. Nd has  $Z = 60$  and electronic configuration  $4f^46s^2$  and the energy of photon emitted in  $n = 4 \rightarrow 5$  transition is 1.1 keV, which seems somewhat too high. If this picture is correct then also the choice of the material in the utmost layer would be one aspect of quantum criticality and allow to understand why it is so difficult to replicate the experiments.

### How the magnetic walls suck energy from the rotating magnetic system

The model is too speculative to allow any strong conclusion about whether the energy is transferred from the rotating system to the magnetic walls of vice versa. It however seems the the most elegant option is that the rotating system provides the energy for the formation of magnetic walls and for the rotation of electrons in the magnetic fields in question.

The transfer of energy could be from the rotating magnetic system to the magnetic walls if the liberated energy is due the dropping of electrons to larger space-time sheets at the boundary of the rotating system and also at the boundary of stator in the case that the corresponding magnetic field rotates. This would explain also the lowering of the temperature in the vicinity of the the system.

A straightforward estimate assuming  $N = 30$  magnetic walls with height  $h = 15$  m (this is only the lower bound for the height) gives for the net magnetic energy of the walls the estimate  $E \sim 10^4$  kJ, which corresponds to the observed maximum power feed of 7 kW for a time interval of  $10^3$  seconds. After the walls are established the dark electrons or their Cooper pairs rotating in the magnetic field of the walls would receive their energy and angular momentum by time mirror mechanism (see fig. <http://www.tgdtheory.fi/appfigures/timemirror.jpg> or fig. 24 in the appendix of this book) from the rotating magnetic system.

The most plausible mechanism for the formation of magnetic walls and generation of rotating Bose-Einstein condensates of dark charged particles at the walls is based on remote metabolism. The simplest option is that Cooper pairs of dark electrons at the magnetic walls suck the energy by emitting phase conjugate photons. The dropping of electrons of Ohmic currents to the space-time sheets of the environment liberating energy in keV range should serve as the primary source of energy: this would naturally occur during the di-electric breakdown.

At first it seems difficult to understand how the negative energy microwave photons from the magnetic walls could transform to negative keV photons inducing radiationless dropping of electron to a larger space-time sheet. The large value of  $\hbar = n\hbar_0$ ,  $n$  integer [K26], suggests a solution to the problem. If one has  $n = E(drop)/E(micro)$ , the energy of the phase conjugate dark microwave photon equals to that inducing the dropping of the electron. What would happen is that the dark microwave photon transforms to an ordinary photon without change in energy but a reduction in wavelength.

For  $E(drop) = 1$  keV and  $E(micro) = .25 \times 10^{-4}$  eV corresponding to a microwave wavelength  $\lambda = 5$  cm one obtains  $n = 5 \times 2^{23}$  with 4 per cent accuracy. For  $\lambda = .5$  m corresponding to the distance between the magnetic walls  $n = 3 \times 2^{27}$  equals to  $E(drop)/E(micro)$  with .1 per cent accuracy so that this option is definitely favored. Both integers define Fermat polygon (a polygon constructible using only ruler and compass) and these integers are number theoretically preferred [K26].

Since the wavelength in question should correspond to a size scale of a rotating magnetic system

to achieve resonance, the quantization of  $\hbar$  and zero point kinetic energy would mean that the effect occurs only for special choices of the scales of the system. This kind of criticality would help to understand why it is so difficult to reproduce the effect and conforms with the intuitive ideas of Searl about the importance of the quantization of length scales characterizing the system.

Obviously it would be very natural for the Larmor wavelength of the magnetic field associated with the walls to correspond to the radius of the stator equal to the distance  $d = .5$  m between magnetic walls. In this situation one could interpret the microwave radiation as cyclotron radiation. The original estimates based on the association of  $f_c = 300$  Hz to the Earth's magnetic field  $B_E = .5$  Gauss indeed led to the estimate  $\lambda = .5$  m. Unfortunately, the calculations contained a systematic error since  $f_c(p) = 300$  Hz corresponds to  $.2$  Gauss: the estimate for the wavelength would become thus  $\lambda = .2$  m.

The discovery of this error forced to reinterpret the effects of ELF radiation on vertebrate brain as being due to cyclotron transitions in dark magnetic field  $B_d = 2B_E/5 = .2$  Gauss accompanying the Earth's magnetic field. If one assumes that magnetic walls carrying maximal ordinary magnetic field  $B = .05$  Tesla are accompanied by dark magnetic walls satisfying  $B_d = 2B/5$ , one obtains  $\lambda = .5$  m instead of  $.2$  m. As a matter of fact, this is not the first time when a calculational error seems to have a beneficial deeper purpose!

### Possible other mechanisms for the remote energy and angular momentum transfer

The proposal that rotating magnetic field could receive its energy and angular momentum from the magnetic walls by time mirror mechanism turned out to be short lived. One can however imagine several mechanisms of remote energy and angular momentum transfer from rotating magnetic system to the magnetic walls besides the one already discussed, and also a mechanism of remote spontaneous magnetization emerges naturally.

1. Remote spontaneous magnetization of Bose-Einstein condensates of Cooper pairs associated with the magnetic walls could feed energy and angular momentum from rollers to walls and possibly also vice versa. Also collective cyclotron states with non-vanishing net angular momentum could be formed via this kind of angular momentum transfer. An essential element would be the conservation of energy and angular momentum and transformation of electron spin and possibly orbital angular momentum due to the rotation in the magnetic field of the wall to the angular momentum of roller.

The remote spontaneous magnetization could compensate a partial loss of roller magnetization and would be achieved by generating phase conjugate microwaves at Larmor frequency corresponding to a magnetic field of  $B = .05$  Tesla with wavelength of  $.2$  meters. The dark magnetic field associated with the living matter in the model for the effects of ELF em fields on vertebrate brain relates to the Earth's magnetic field via the relationship  $B_d = 2B_E/5$ . If the dark magnetic field relates to observed maximal magnetic field by the same scaling factor, the wave length is  $.5$  meters and corresponds to the radius of the stator magnet. If the phase conjugate microwave photons are dark with large  $\hbar$  this requires that these photons de-cohere to  $N$  ordinary phase conjugate microwave photons absorbed by the stator or rotor magnet. This looks like self assembly to single dark negative energy photon when looked in the normal direction of geometric time.

2. The generalized four-wave mechanism allows much more general standing waves than the usual theory and plasma oscillations and magnetostatic waves are ideal in this respect since their dispersion relation is such that plasma frequency does not depend on wave vector at all. Magnetostatic waves in the stator are good candidates for generating the microwave photons at wavelengths of  $.5$  m responsible for standing wave with magnetic walls at its nodes and for spin flips inside the magnetic walls. The Larmor frequency of electron in the rollers would correspond to a wavelength equal to the thickness of the magnetic walls and the microwaves resulting in spin flips in roller magnets could be responsible for the generation of magnetic walls.
3. The Larmor frequency for the maximal  $.02$  Tesla dark magnetic field associated with walls at critical frequency corresponds to  $.76$  GHz and wavelength of  $.5$  meters, the radius of the stator. Hence this magnetic field strength might relate to a microwave resonance at cyclotron

frequency and with a wavelength equal the radius of the stator, and somehow providing the angular momentum needed by the system starting to accelerate spontaneously when the resonance condition for wavelength is satisfied. Lowest cyclotron transitions and spin flip transitions inside magnetic walls would have this frequency naturally and the magnetic walls would appear at the nodes of the waves.

4. What comes in mind is the presence of Bose-Einstein condensate of electronic Cooper pairs with spin  $J = 2$  created above the critical frequency at the space-time sheets representing magnetic walls and possessing angular momentum opposite to the angular momentum gained by the rollers spontaneously.
  - (a) The spin flips inside rollers transform part of electronic spin to the angular momentum of the roller and tend to change roller magnetization. By the stability of the spontaneously magnetized state, the effect of spin flips on magnetization of the roller is compensated by the reversals of the spin flips.
  - (b) The compensating spin flips in the roller at the Larmor frequency  $f_L = 12$  GHz are accompanied by transverse magnetostatic waves in the stator. The frequency corresponds to the factor

$$\epsilon = \Phi - 1 = \frac{\sqrt{5} - 1}{2}$$

for the magnetic field  $H = \epsilon M_0$  of roller inside stator. What is interesting is that Golden Mean appears. Only those regions of the stator, where this condition is satisfied contribute significantly to the spin flips and an optimal distance between rollers and stator is crucial for the mechanism to work. The spin flips are mediated by the emission of microwave photons at 12 GHz frequency.

It is interesting that Golden Mean appears also in another manner in the system. The ratio of the thickness  $d$  of the dark magnetic walls (twice the wavelength of 12 GHz microwaves) to the radius  $R$  of the stator equals to  $1/10$  in a good approximation. These lengths correspond to phase increments of  $2\pi$  and  $2\pi/10$  for the corresponding waves. The phase increment of  $2\pi/10$  relates directly to the Golden Mean by  $\cos(2\pi/10) = \frac{4-\Phi}{2}$ .

5. The change in the magnetization of the stator is compensated by spin flips and generation of orbital motion of electrons inside dark magnetic walls and now the frequency in question is .6 GHz corresponding to the wavelength .5 m. This explains why spontaneous acceleration starts at critical frequency. The correct prediction is that the magnetization directions of the rollers and magnetic walls must be same.

The Bose-Einstein condensates of Cooper pairs play a central role in the TGD inspired theory of living matter and are made possible by the many-sheeted space-time concept. Spontaneous magnetization of spin  $J = 2$  Cooper pairs of electrons at the space-time sheets of the magnetic walls liberating rotational angular momentum could represent the precise mechanism of spontaneous acceleration. The emission of phase conjugate microwave photons at wavelength of .5 meters by the magnetostatic waves rotating in the stator magnet could induce the spontaneous magnetization, which corresponds to a lower energy than the non-magnetized phase.

### 4.3.7 Connection with the dark matter hierarchy

The discovery of years 2004-2005 was that in TGD Universe Planck constant  $\hbar$  could be dynamical and quantized and that TGD in principle predicts the spectrum of Planck constant allowing also a well-educated guess of its spectrum. A further proposal is that for a given p-adic prime there could be hierarchy of Planck constants with arbitrarily large values. These ideas have meant breakthrough in interpretational issues of TGD, and as I write this I am still working through the TGD inspired theory of living matter and consciousness armed with this new understanding.

### Basic vision about dark matter hierarchy

I will not repeat the basic ideas related to the dark matter hierarchy since they are discussed thoroughly in previous chapters. Suffice it to say that the levels of dark matter hierarchy are partially characterized by a non-negative integer  $k_d$  characterizing the value of  $\hbar$  as  $\hbar(k_d) = \lambda^{k_d} \hbar_0$ ,  $\lambda \simeq 2^{11}$ . Also more general values of  $\lambda$  are possible and  $\lambda$  is predicted to be integer valued [K26] with integer values  $\lambda = n_F$  corresponding to Fermat polygons defined as n-polygons constructible using only ruler and compass being favored. For these values of  $n$  the quantum phase  $q = \exp(i\pi/n)$  is expressible in terms of square roots of rationals. The integers  $n_F$  are expressible as products  $n_F = 2^k \prod_i F_{s_i}$ , where  $F_s = 2^{2^s} + 1$  is Fermat prime and appears at most once in the product.  $s = 0, 1, 2, 3, 4$  gives the lowest Fermat primes 3, 5, 17, 257,  $2^{16} + 1$ .

Large  $\hbar$  phase means that de Broglie and Compton wave lengths as well as corresponding time scales are multiplied by a factor  $\lambda^{k_d}$ . If particle densities are not reduced in the phase transition to the dark matter phase, the quantum sizes of particles, which correspond to sizes of space-time sheets, become so large that particles overlap. The standard criterion implies that macroscopic quantum phases become possible.

The situation in which phases  $k_d$  and  $k_d + 1$  compete has interpretation in terms of quantum criticality. Poincare invariance implies that four-momentum and spin are not changed in the phase transition  $\hbar \rightarrow \lambda\hbar$ . This means that spin is fractionized by  $1/\lambda$  factor making possible fractional spins if  $\lambda\hbar$  is used as a unit. The concrete interpretation of large  $\hbar$  phases at space-time level is following. What happens that space-time sheet becomes analogous to a  $\lambda$ -sheeted Riemann surface defining  $\lambda$ -fold covering of  $M^4$  locally. At space-time level the transition to quantum criticality would thus correspond to a single step in the transition to chaos, not by period doubling but by  $\lambda$ -pling (and more generally, period -pling by a harmonic or subharmonic of  $\lambda$ ).

An important application is the quantum model for high  $T_c$  super-conductivity [K14, K15]. This model predicts the basic length scales of cell (cell membrane thickness of  $L(151) = 10$  nm, the thickness  $L(149) = 5$  nm of single lipid layer of the cell membrane, and the over all size of cell like structure involved as  $L \leq L(173) = 20 \mu$ ). The emerging model of bio-system as high  $T_c$  superconductor is discussed in [K14, K15]. The basic prediction is that fractally scaled up variants of the cell nucleus with size scales  $\lambda^{k_d}$  should be fundamental for understanding of not only living matter but perhaps also the em and  $Z^0$  interactions at the level of magnetosphere.

The energy of the cyclotron states behaves as  $\lambda^{k_d}$  for given  $B$ . Bose-Einstein condensates associated with cyclotron states in Earth's magnetic field  $B_E = .5$  Gauss would be fundamental for bio-control and for  $k_d = 4$  all ions satisfying  $A \leq 223Z$  have cyclotron energy scale above the thermal threshold 86 meV at room temperature. Cyclotron frequencies are in EEG range and most bosonic ions have cyclotron frequencies in alpha band around 10 Hz. Electron cyclotron states satisfy the thermal stability criterion at room temperature even for  $k_d = 3$  for  $B_E$ . For  $k_d = 4$  the size of magnetic flux quanta is about 10 Earth radii so that dark matter hierarchy provides a justification for the notion of magnetic body.

### Magnetic walls as reservoirs of dark energy and angular momentum?

This general picture suggests that the magnetic walls associated with the rotating magnetic system contain dark matter Bose-Einstein condensates in cyclotron states having angular momentum and that the spontaneous acceleration of the system is forced by angular momentum conservation as this Bose-Einstein condensate is formed. Since the maximal value of magnetic field is  $2^{10} B_E = .05$  Tesla, cyclotron states of electron Cooper pairs are thermally stable at room temperature even for  $k_d = 2$ . Magnetic walls would be the counterparts of cell membranes and  $k_d = 2$  for  $\lambda = 2^{11}$  predicts them to have thickness of  $\lambda^2 L(151) = 4$  cm whereas the experimental value is  $\sim 5$  cm. The upper bound for the size of system consisting of magnetic walls, analogous to endoplasmic membranes inside cell, would be  $\lambda^2 L(173) = 80$  m.

Magnetic walls could serve as angular momentum and energy storages if the Bose-Einstein condensation occurs to a cyclotron state carrying angular momentum. The accelerating rotating system could suck energy and angular momentum from this reservoir by time mirror mechanism which means sending of negative energy phase conjugate photons absorbed by the Bose-Einstein condensate. Note however that the accelerated rotation can be explained in terms of Lorentz torque suffered by the radial ohmic currents.



In the model of living matter  $k_d = 4$  bosonic ions at magnetic flux tubes are in a key role and the cyclotron frequencies of most bosonic ions belong to alpha band around 10 Hz. It becomes possible to explain the not only the band structure of EEG but also the narrow sub-bands correctly [K15, K22]. 10 Hz frequency is the rotation frequency of rotating magnetic system and this suggests that also  $k_d = 4$  for which cell membrane thickness is scaled up to about 160 nm and cell size to about 10 Earth radii is involved.

### Also $Z^0$ magnetic walls could be involved

The large parity breaking observed in rotating magnetic systems suggests that also long ranged weak fields are involved with the dynamics of Searl device. Hence one can ask whether also weakly charged dark matter could be involved. Exotic ions having both weak and em charges result when some nuclear color bonds having quark  $q$  and antiquark  $\bar{q}$  at their ends become charged  $u\bar{d}$  or  $d\bar{u}$  type color bonds, are possible and might be of relevance for living matter [K71, K23]. These exotic ions couple to  $k_d = 1$  dark variants of  $k = 113$  exotic weak bosons. These couplings would be essential for the understanding the chiral selection in living matter.

By the general considerations of [K23, K15] weak dark length scales and em dark scales correspond to each other via  $k_d^W = k_d^{em} + 2$  implying  $k_d^W = 4$  for rotating magnetic systems. Hence  $Z^0$  cyclotron energies which are apart from numerical factor identical with corresponding em energies would be thermally stable at room temperature for  $g_Z B_Z = eB_E$ . The weak length scale deduced by scaling the Compton length of ordinary intermediate boson with  $k = 89$  to  $k = 113$  gives  $L_W(113, k_d = 2) = .2 \mu\text{m}$ . For  $k_d = 4$  one has  $L_W(113, 4) = .8$  meters, not too far from the distance .5 m between magnetic walls.

These observations suggest that the decomposition  $2 + 2 = 4$  cm defining the analog of decomposition of cell membrane to lipid layers corresponds to decomposition to two 2 cm thick walls containing neutrino Cooper pair condensates with opposite angular momenta and generating  $Z^0$  magnetic field  $g_Z B_Z = eB_E$  inside the .5 meter thick wall. These walls could contain Bose-Einstein condensates of exotic  $O_2$  and  $N_2$  ions thermally stable at room temperature. Interestingly, for exotic  $O_2^+$  ions the  $Z^0$  cyclotron frequency would be in a good approximation equal to 10 Hz.

### Is dark matter formed in the air between stator-roller interface?

If stator magnetic field rotates, the situation becomes especially interesting in the small air gap between roller and stator since the electron currents coming from the stator could be transferred to the roller and since very high positive surface charge densities could result in the air gap.

Dark matter identified as a phase with a large value of Planck constant [K26] is in a fundamental role in the TGD based model of living matter [K23, K21, K22]. The formation of large magnetic flux quanta suggests quantum criticality implying a large value of Planck constant so that one can wonder whether some form of dark matter could be formed in this region.

### 4.3.8 A general catastrophe theoretic model for the spontaneous acceleration

Spontaneous acceleration requires non-linear dynamics allowing what looks like a phase transition at some critical angular velocity to a situation in which spontaneous acceleration begins so that one can stop the feed of angular momentum and energy to the system. One could imagine that the system stores part of the feeded angular momentum and energy and when some critical amounts of these quantities are stored they are liberated as something analogous to metabolic energy and used by system so that spontaneous acceleration takes place. Magnetic body of the system could serve as storage as already discussed. It is not clear whether this mechanism necessarily involves dissipation and a temporary reversal of the thermodynamical arrow of time in a time scale relevant for the behavior of the system. The following model assumes this and also the report about the cooling of the nearby environment support this assumption.

1. The simplest model would be equation of motion stating that the time derivative of angular momentum equals to a net torque containing besides the external torque plus dissipative terms plus additional term anti-dissipative term:

$$\frac{dL}{dt} = P_3(\omega, \tau_0) = \tau_0(t) - \tau_1(t)\omega + \tau_2(t)\omega^2 - \tau_3(t)\omega^3 . \quad (4.3.81)$$

The parameters  $\tau_i(t)$  are assumed to be slowly varying in the time scale of the dynamics of  $L$ . In catastrophe theoretic setting [A16]  $\tau_i$  *resp.*  $\omega$  would be called control parameters *resp.* behavior variable. Note that the model is asymmetric with respect to the change of the direction of  $\omega$  and applies only for positive values of  $\omega$  unless one uses  $|\omega|$  as a variable. Other terms are also present in the equation but they are neglected since the interest is solely in the essentials of the dynamics due to the dissipative and anti-dissipative terms.

- (a)  $\tau_0(t)$  characterizes the external angular momentum feed. One can assume that  $\tau_0(t)$  is constant.

$$\begin{aligned} \tau_0(t) &= \tau_0 \text{ during external angular momentum feed ,} \\ \tau_0(t) &= 0 \text{ in absence of angular momentum feed .} \end{aligned} \quad (4.3.82)$$

- (b) The term  $-\tau_1\omega$  corresponds to dissipative loss of energy. The dissipative term  $-\tau_3\omega^3$  is necessary in order to avoid endlessly increasing  $\omega$ , which is definitely something non-realistic.

- (c) The presence of  $\tau_2\omega^2$ ,  $\tau_2 > 0$ , can make possible self-sustained situation and acceleration. This term could correspond to liberation of angular momentum gathered during the earlier phase and starting to be liberated after critical angular velocity  $\omega_{cr}$  (or possibly critical angular momentum  $L_{cr}$  stored to say magnetic body) has been achieved. It could be also interpreted in terms of an effect related to the breaking of second law below some time scale predicted to be possible in TGD Universe. There is empirical evidence for this kind of breaking in .1 second time scale defining a fundamental biorhythm [D18] .

2. By construction the system realizes cusp catastrophe [A16] describing the simplest possible situation in which some parameter region of the parameter space allow 3 or only 1 root to the stationarity condition  $P_3(\omega, \tau_0) = 0$  so that one has a phase transition like behavior. The following considerations show that if  $P_3(\omega, 0)$  allows three non-negative roots and  $P_3(\omega, \tau_0)$  only one positive root, then sufficiently long lasting feed of angular momentum allows to achieve a self-sustaining and accelerating situation, which lasts as long as  $\tau_2(t)$  characterizing self-sustainment remains large enough. After this a phase transition to a phase characterized by a rapid decrease of  $\omega$ , occurs.
3. One can concretize the situation by imagining that the system climbs to a mountain during the periods of external angular momentum feed and slides down when the feed is off in the case that one has

$$R \equiv \lim_{t \rightarrow t_f, +} \frac{dL}{dt}(t) = P_3(\omega(t_f), 0) < 0 . \quad (4.3.83)$$

Here  $t_f$  denotes the value of time when external feed of angular momentum. For  $R > 0$  the climbing up continues spontaneously but with a slower rate.

4. Quite generally,  $P_3(\omega, \tau_0)$  can have  $n = 0, 1$  or  $n = 3$  zeros in the region  $\omega \geq 0$ .  $P_3(\omega, 0)$  has always zero at origin and can have two additional zeros if  $\tau_2(t)$  is large enough. Since the polynomials  $P_3(\omega, \tau_0)$  and  $P_3(\omega, 0)$  differ only by a downwards shift by  $\tau_0$ , one finds the following.

(a) If one has

$$P_3(\omega, \tau_0) < \tau_0 \quad (4.3.84)$$

for  $\omega > 0$ ,  $P_3(\omega, 0)$  has only one non-negative zero for all positive values of  $\omega$ . The system slides down towards  $\omega = 0$  in absence of external energy feed.

(b) If the condition

$$P_3(\omega_f, \tau_0) \geq \tau_0 \quad (4.3.85)$$

is satisfied,  $P_3(\omega_f, 0)$  has two positive roots ( $\omega_{2,0}, \omega_{3,0}$ ) besides  $\omega_{1,0} = 0$ . If  $R$  is in the region above  $\omega_{2,0}$ , the system slides down to or climbs up to  $\omega_{3,0}$  after the angular momentum feed has ceased. This situation is obviously the interesting one in the recent case. Whether the region  $\omega > \omega_{2,0}$  can be reached during this period depends on the properties of  $P_3(\omega, \tau_0)$ .

5. Consider first what happens during angular momentum feed assuming that  $P_3(\omega_f, 0)$  has two positive roots ( $\omega_{2,0}, \omega_{3,0}$ ) besides  $\omega_{1,0} = 0$  (the interesting case).  $P_3(\omega, \tau_0)$  has certainly one root since  $P_3(\omega, f)$  becomes eventually negative due to the term  $-\tau_3\omega^3$ .

(a) If  $\tau_0$  is large enough there is only one root - call it  $\omega_3$ . One has  $\omega_3 > \omega_{3,0}$  and the energy feed - if allowed to continue long enough or for sufficiently many times- drives the system above  $\omega_{2,0}$  and eventually to  $\omega_3$ , which is stable and is reduced only slowly as  $\tau_2(t)$  decreases. When angular momentum feed ceases, the system goes to  $\omega_{2,0}$ , which represents a stable situation and only adiabatically approaches to zero as long as the number of roots remains three. After this  $\omega$  goes rapidly to zero.

(b) If  $\tau_0$  is small enough one has one or three roots- let the three roots be  $\omega_1 < \omega_2 < \omega_3$ .  $\omega_1$  corresponds to a stable situation in which the linear term has driven  $dL/dt$  to zero. One ends up to this situation either from  $\omega \leq \omega_2$  for three roots and always if one has only one root. Only  $\omega_1$  is achievable by starting from  $\omega(t=0) = 0$  or from  $\omega(t_f)$  achievable during the period of angular momentum feed. Since the graphs of  $P_3(\omega, \tau_0)$  and  $P_3(\omega, 0)$  differ only by a shift, it is clear that one has  $\omega_1 < \omega_{2,0}$  so that the system rapidly slides down to  $\omega = 0$ .

6. The conclusion is that the desired situation can be achieved only if  $\tau_2(t)$  is so large that  $P_3(\omega, \tau_0) > \tau_0$  holds true at the maximum of  $P_3(\omega, \tau_0)$  (for  $\omega > 0$ ) and  $\tau_0$  is so large that  $P_3(\omega, \tau_0)$  has only single root. This means that the minimum of  $P_3(\omega, \tau_0)$  is positive. The extrema  $\omega_{\pm}$  of  $P_3(\omega, \tau_0)$  correspond to the vanishing of  $dP_3(\omega, \tau_0)/d\omega$  so that one has

$$\begin{aligned} \omega_{\pm} &= \frac{\tau_2}{3\tau_3} \pm \sqrt{\left(\frac{\tau_2}{3\tau_3}\right)^2 - \frac{\tau_1}{3\tau_3}} \ , \\ \left(\frac{\tau_2}{3\tau_3}\right)^2 - \frac{\tau_1}{3\tau_3} &\geq 0 \ , \end{aligned} \quad (4.3.86)$$

The conditions for self-sustainment boil down to the equations

$$\begin{aligned} P_3(\omega_+, 0) &> 0 \ , \\ P_3(\omega_-, \tau_0) &> 0 \ . \end{aligned} \quad (4.3.87)$$

Self-sustaining situation continues as long as  $\tau_2(t)$  is so large that one has 3 roots for  $P_3(\omega, 0)$ . For small enough  $\tau_2(t)$  the two roots disappear and the system slides rapidly to  $\omega = 0$ . Fig. ?? illustrates these conditions graphically.

### 4.3.9 Discussion

Searl machine seems to be unique in the sense that physical constraints pose strong limitations on the possible scaling of the system. The effects exhibited by Searl machine might be important for the functioning of the living matter and even in systems like tornadoes.

#### About the basic construction and its modifications

The basic construction deserves some comments.

##### 1. Optimization

According to the proposed dynamical model of the Searl machine, the optimal situation corresponds to a rotation starting spontaneously at rest or almost at rest. This requires that the purely electromagnetic Lorentz torque wins the friction torque. The minimization of friction torque and the maximization of magnetic field strength could help here. Electromagnets might allow to achieve field strengths considerably above 1 Tesla.

Since Lorentz torque is proportional to conductivity, the maximization of conductivity provides a promising approach to the optimization of the effect. The Lorentz torque is generated by Hall effect. Quantum Hall effect (QHE) is studied in temperatures for which thermal energy is of order of electron's Larmor energy  $E_e = eB/2m_e \simeq 1$  K for  $B = 1$  Tesla. QHE involves an enormous increase of the conductivity (up to 13 orders of magnitude!) at certain critical value ranges of the magnetic field in the range of field strengths varying from 1 Tesla to 30 Tesla (see the figure 1.2 of [D26]).

This raises the hope that QHE might allow to build small spontaneously accelerating magnetic systems with enormous Lorentz torque as compared to that observed at high temperatures. The dynamics of topologically rotating magnetic field of rotor would play a key role since the increases of the conductivity would in TGD Universe relate to the formation of magnetic walls [K84]. By the quantization of the magnetic flux the increase of the magnetic field strength means on one hand the reduction of the flux tube radius and the increase of the number of flux tubes on the other hand, and can lead to a partial fusion of the flux tubes at certain critical field strengths giving rise to highly conducting magnetic walls. If these walls are formed in the radial direction, large radial electron current becomes possible.

Quantum criticality is a prerequisite for the existence of the effects and hence also crucial for the optimization. In particular, the size scales of the system are important since the dark microwave photons from the magnetic flux walls must have wavelength of order system size in order to achieve a resonant absorption. This wavelength corresponds also to the separation between magnetic walls. The energy of dark microwave photons must correspond to the increment of the zero point kinetic energy of dropped electron, and the fact that only certain values of quantized Planck constant seem to be favored, poses additional constraints. Furthermore, the ionization energy of valence electron of the atom in the uppermost layer must correspond to the increment of the zero point kinetic energy of electron poses conditions on the selection of the material.

##### 2. Testing

For testing purposes modular structure of rollers and stator allowing to vary the geometric parameters would be highly desirable. The use of electromagnets would allow to test the effect of field strength. In particular, one could see whether the thickness of magnetic walls corresponds to twice the wavelength defined by the Larmor frequency of electron. The use of vertical electric field would allow to test whether it is indeed electric field of Earth which is responsible for the dominant part of the effective weight change.

The rotation of rollers should generate also  $Z^0$  magnetic field. Radio active decay rates are reported to change near the Searl effect generator. Long range classical  $Z^0$  field affects weak interactions and thus also the radio active decay rates. Effects are similar to the effects caused by a classical background em field and give rise to corrections, which are of order  $\alpha_Z Z^2/m_\nu^4$ , where  $Z$  is essentially  $Z^0$  field strength at the position of the decaying nucleus. If classical  $Z^0$  field has strength at least of order  $1/L(169)^2$ ,  $L(169) \simeq 5$  micrometers, the effect is significant. What happens that in a Feynman diagram describing the decay of d quark to u quark by the emission of virtual  $W$  boson decaying to electron and neutrino, the neutrino interacts with the classical  $Z^0$

field in the final state. Recall that classical  $Z^0$  field explains also the dependence of the effect on the direction of rotation although also the spontaneous parity breaking caused by the generation of the radial electric field could also explain this effect. The systematic study of the radio active decay rates obviously provides a clear-cut test for whether classical  $Z^0$  fields and even  $W$  fields are present.

### 3. *Is it possible to scale down the magnetic system?*

The construction used in the experiments of Godin and Roschin is rather massive and one might ask whether it is possible to use constructions having a smaller size.

The scaling should respect both length scale ratios and frequency ratios. Furthermore the length scale associated with the Larmor frequency of electron should be scaled also. This means that the scaling of dimension down by a factor  $x$  requires a scaling of a magnetic field by a factor  $1/x$ . Already Russians use rare Earth magnet Neodymium [H33] with a magnetic field of 1 Tesla which seems to be maximal field allowed by condensed matter properties. This seems to exclude the scaling downwards.

The critical frequency for the clockwise (counter clockwise) rotation is 9 (10) Hz. The new-physics explanation is as the frequency above which magnetic torque becomes larger than the friction torque and spontaneous acceleration becomes possible. In TGD based model for brain ELF frequencies in EEG range play a fundamental role and one cannot exclude that also now phase conjugate ELF waves are involved and the criticality also in this sense holds true. An imaginative explanation for the known experimenter dependence of the Searl effect and over unity phenomena in general would be that part of the energy is sucked from the brain or body of the experimenter having strong desire that the device works!

Be it as it may, 10 Hz is a fundamental p-adic frequency serving as clock in living matter as well as a resonance frequency for oscillations inside the cavity defined by the ionosphere (not the same as Schumann frequency). Furthermore,  $Z^0$  cyclotron frequencies vary in the range 9 – 10 Hz in Earth's  $Z^0$  magnetic field estimated to be 16 times weaker than the ordinary magnetic field of Earth. One cannot exclude the possibility that the phenomenon involves ELF fields in an essential manner and therefore length scales of order Earth size defined by the corresponding wave lengths. This would also fix the frequency scale to that used in the experiments of Russians and only fine tuning could be considered.

Rollers have radius of about 3.7 cm and one could of course imagine of modifying the stator by replacing it by a smaller structure. Russians do not give justification for why the ratio  $R/r$  of the radii of the stator and rollers should be integer not smaller than 12 by the requirement of a magnetostatic resonance. Already for  $R = r$  6 rollers are possible and for  $R = 2r$  9 rollers are possible. This might provide a possibility of downwards scaling.

### 4. *Could one simplify the basic system?*

The natural question is whether one could simplify Searl device. There are indeed several variants of rotating magnetic systems claimed to be over unity systems (Jean- Louis Naudin's homepage [H9] contains a lot of material about these devices). The simplest possible device of this kind would involve only rotor and stator disks which lay in parallel over each other and have same symmetry axis. Magnetization would be orthogonal to the disks and the use of several stator disks would help to achieve more intense magnetic field inside rotor disk. Rotor disk could also reside between stator disks. In this case only purely electromagnetic Lorentz force would be present and if Lorentz torque is large enough to win the friction torque the system should start to rotate spontaneously. No directional asymmetry would be present since the  $Z^0$  magnetic field created by the rotor disk is not rotating  $Z^0$ . A working device of this kind is indeed claimed to exist and the rotation is indeed reported to start spontaneously [H15]. The company Perendev Power Developments Inc. of the inventor Michael J. Brady is reported to have started manufacturing of a unit producing a power of 20 kW.

## **Searl effect and bio-control**

The model of Searl effect is based on essentially the same mechanisms as applied in the quantum models for homeostasis and remote mental interactions [K32, K34].

Strong parity breaking implied by the  $Z^0$  magnetization and the crucial role of neutrinos is the

first common aspect. In living matter the key mechanism is the remote quantum entanglement having as a space-time correlate low frequency MEs, and self-organization induced by the high frequency MEs by inducing bridges between, say, magnetic flux tubes and atomic space-time sheets. In particular, the notion of magnetic body is of absolute essential for the model and has astrophysical size. In the case of Searl machine magnetic walls play the role of the magnetic body. This inspires the questions whether living matter utilize Searl effect routinely so that the model for the generation of magnetic walls might be applied also to model the generation of the magnetic body in living matter.

I have proposed in [K58] that time reversal is the basic mechanism of healing. The biological programs simply run backwards to the point, where the error occurred, and a new trial is made. De-differentiation is the counterpart of this mechanism at the cellular level. Stem cells are indeed increasingly used for healing purposes, leucemia being one example of this. The model of Priore's machine [I19, I15] is based on this idea and involves phase conjugates of microwaves perhaps inducing time reversal mode of molecular machines at DNA level and thus leading to the correction of the genetic error responsible for the cancer. Irradiation by phase conjugate microwaves at critical frequencies might induce the time reversed mode and thus provide a possible general healing mechanism affecting directly the DNA level.

These observations suggest that various molecular machines such as  $F_0 - F_1$  machine responsible for the metabolism (and its variants suggests by the many-sheeted space-time concept) might at least in their time reversed mode induce time reversals of biological programs and thus healing. The generation of negative energy MEs would induce bound state entanglement and the liberated binding energy would compensate the lack of the metabolic energy feed during the time reversed mode. They could also induce anti-gravitational effects, which together with the macroscopic quantum coherence induced by negative energy MEs, could be an essential aspect of the locomotion of the living organism. Molecules, which have temporarily got partially rid of effective weight would be ideal for the catalysis in the many-sheeted space-time..

One can thus ask whether some molecular machines are actually Searl machines, at least in their time reversed mode. For instance, the  $F_0 - F_1$  machine driving protons to atomic space-time sheet from (presumably) magnetic flux tubes of Earth, is much like a power plant containing a rotating shaft. In time reversed mode, in which it acts like a motor, the shaft might have reduced weight. The parity breaking effect induced by the classical  $Z^0$  force would also favor second direction for rotation, this is obviously essential in order to achieve a synchronous action.

A further interesting aspect is that the presence of ELF waves at 10 Hz defining a fundamental bio-rhythm implied by rotation means that the interaction with the body and brain of the experimenter might interfere with the experiment. The importance of the experimenter's intention would conform with the finding that free energy effects are not fully re-producible. This only adds to the fascination of these effects if one is ready to give up the reductionist and materialistic dogmas and accept the possibility of remote mental interactions. Of course, the possibility of this remote mental interaction in bodily length scales would be absolutely essential for the possibility to realize intention by using molecular machines.

### Could tornadoes involve Searl effect?

For a rotating vortex in water or air an analogous mechanism might work and so that the rotating vortex would begin to accelerate. Elastic force is essential in the previous example and in case of water or air pressure should provide its counterpart. One might think that the water or air in the vortex expands upwards since the gravitational force pressing the liquid downwards is reduced and pressure remains the same unless temperature is changed. Tornadoes might involve this mechanism. Usually the reduction of the pressure in the core of the tornado is believed to cause its destructive effects but the reduction of the effective gravitational force due to the  $Z^0$  and em charging might be also involved. The observed light phenomena associated with tornadoes support the presence of plasma phase due to the Faraday effect forcing the flow of electrons from the interior of vortex.

Hydrodynamical vortices contain typically smaller vortices and one might consider the possibility that the tornado contains at its outer boundary smaller mini tornadoes playing the role of rollers whereas the central vortex would give rise to a non-rotating  $Z^0$  magnetic field and would act as a stator.  $Z^0$  magneto-static waves in air would replace magneto-static waves as a mechanism of remote metabolism. Larmor frequency would be now the Larmor frequency of neutrinos in the  $Z^0$

magnetic field generated by the tornado. Since neutrino mass is about  $5 \times 10^6$  times smaller than electron charge, quite high frequencies are possible. The generation of vacuum extremals would guarantee the coupling of  $Z^0$  fields to em fields and therefore the generation of negative energy photons crucial for the remote metabolism. As noticed, the tornadoes can be accompanied also by emission of visible light. Perhaps this is both due to the remote metabolism and the presence of plasma resulting in the rotation of a magnetized structure. The temperatures of air can be as low as  $-80$  C in the space above tornadoes [H42], which also suggests the presence of time mirror mechanism of energy metabolism and reversal of geometric arrow of time.

It should be noticed (thanks for Juha Hartikka for proposing this), that one could understand Podkletnov effect if a part of the volume above the rotating super-conductor belongs to the space-time sheet of the rotating super-conductor. Matter at this space-time sheet would lose part of its gravitational mass. The resulting incomplete cancellation of the pressure gradient and gravitational force would also explain why the air above the system started to flow upwards.

## 4.4 Effects related to Searl effect

N-machine of dePalma and and space-energy generator of Tewari represent situations in which the basic mechanisms underlying Searl effect seem to be involved. Also anomalies associated with spinning systems such as gyroscopes could have explanation in terms of Searl effect.

### 4.4.1 N-machine of DePalma and space-energy generator of Tewari

The experiments of Faraday related to a rotation of cylindrical magnet with conductor disk attached rigidly on its top, are not well known to average physicist [H6]. The outcome these experiments was that radial electric field is generated between the rim and axis of the rotating conducting disk. This effect does not follow from Faraday's law of induction and is not satisfactorily understood in Maxwell's electrodynamics and it is somewhat surprising that Faraday's experiment has not received more attention.

[H20] [H20] has repeated the experiments of Faraday and he claims that so called N-machine (DePalma generator), which is basically conducting disk attached rigidly to a cylindrical magnet and rotated using external power input, transforms mechanical energy to electric energy with efficiency larger than one (out put power is larger than input power!). Perpetuum mobile is not in question: rather, the claim is that there is some unknown form of energy, which is transformed to electric energy. Indian physicist Tewari [H6] has replicated DePalma's results and constructed what he calls space power generator: N-machines are fabricated commercially in Japan.

Consider now the possible working principle behind N-machine (De Palma generator) [H20]. space energy generator of Tewari [H6].

When one extracts electric energy from a system consisting of a rotating magnet with conductor disk attached to it, the electric field tends to dissipate. The possibility to generate new vacuum charge however compensates this energy and the ratio of output power to input power can quite well be larger than one.

The model of N-machine and space-energy generator relies on simple observations about rotating magnetic systems. The radial ohmic current induced by the radial electric field having non-vanishing vacuum charge density implies a continual charging of the system. This implies that system gains high Coulomb energy and eventually di-electric breakdown occurs. The simplest manner to extract energy from the system is to connect the system with ground via a load so that the charge can flow through it and di-electric breakdown is avoided.

The energy needed for the charging must come from somewhere and the model for Searl device suggests that the energy is extracted from magnetic walls containing dark matter by sending negative energy phase conjugate (dark) photons absorbed by the dark particles in the wall. The dropping of charges to larger space-time sheets liberating zero point kinetic energy could be the ultimate source of energy. The process cannot continue indefinitely in the absence of energy feed kicking the charges back. In living matter the solar energy feed would take care of this.

In many-sheeted space-time particles topologically condense at all space-time sheets having projection to given region of space-time so that this option makes sense only near the boundaries

of space-time sheet of a given system. Also p-adic phase transition increasing the size of the space-time sheet could take place and the liberated energy would correspond to the reduction of zero point kinetic energy. Particles could be transferred from a portion of magnetic flux tube portion to another one with different value of magnetic field and possibly also of Planck constant  $\hbar_{eff}$  so that cyclotron energy would be liberated.

One could of course ask whether the generation of negative energy space-time sheets could provide a manner to generate energy indefinitely. Probably this is not the case, since it is essential the negative energy space-time sheets represents phase conjugate bosons which are absorbed by some system. The absorption occurs with a large rate if the absorbing system is analogous to a population inverted laser and cannot thus continue indefinitely unless there is continual external energy feed, such as solar radiation, regenerating the population inversion. What this mechanism however makes possible is non-local utilization of energy. For instance, there is no need for a rocket to carry its fuel since the generation of phase conjugate radiation interacting very weakly with positive energy matter would make possible remote use of energy.

#### 4.4.2 Some anomalies related to the behavior of spinning systems

The discussion of the anomalies related to spinning bodies described in [H37, H38] turned out to have extremely fruitful impact to the challenge of anchoring the concept of the classical  $Z^0$  field to experimental reality. These anomalies have also a close connection with those exhibited in the behavior Searl device.

##### Anomalies in spin-spin interaction of spin polarized nuclei

As a result of various experimental and theoretical studies [C10] , [H18, H45] , [J4] spin-spin interaction of spin polarized nuclei with spin polarized nuclear targets and distant correlations of nuclear spin states were discovered and investigated. These interactions were called "pseudo-magnetism" and the clear understanding of the underlying mechanism was lacking. Since TGD predicts that nuclei can have anomalous  $Z^0$  charges giving rise to interactions in the weak length scale  $L_w$  of order atomic length scale [K71] , the identification of pseudo-magnetism as a manifestation of classical  $Z^0$  magnetism suggests itself since TGD.

There are well established effects described in the article by Krisch in New Scientist 1979 [C31] and related to the scattering of protons on protons, which according to [H37, H38] are hard to understand in the standard physics framework. The hard inelastic large angle scattering rate for parallel spins is roughly by a factor 4 larger than the rate for antiparallel spins.

A possible explanation is based on classical magnetic and  $Z^0$  magnetic fields, which are in good approximation dipole fields. These fields would be present if the topological condensation of also proton involves the formation of quark pair corresponding to sea quark/antiquark with p-adic length scale  $L(107)$  and exotic anti-quark/quark with length scale  $L(127)$  so that also topologically condensed proton, or better to say "H nucleus", is accompanied by color and electro-weak field body represented by a (possibly branched) loop (structure) of size of order atomic radius.

Exotic quark and antiquark would have opposite spins and would be connected by magnetic and  $Z^0$  magnetic flux tubes defining their magnetic bodies. Parallel spins give rise to magnetic dipole moments and parallel/opposite magnetic moments attract/repel each other when on same line. The interaction would be due to the *genuinely* classical magnetic and  $Z^0$  magnetic flux tube structures connecting exotic quark and its anti-quark. This implies that large angle scatterings in which quarks scatter form each other, are more probable for parallel configuration of spins than for antiparallel configuration. If this explanation has some correlation with reality, these effects could be seen as a direct signature of topological condensation implying the formation of parton pairs associated with # contacts and also as an empirical support for the notion field body.

##### Anomalies in the motion of spinning gyroscopes

There are large number of reports about anomalous effects related to gyroscopes and gyroscopic systems. Variations of the weight of the gyroscope depending on the angular velocity and direction of spinning are reported [H20, H27] , [J23] . According to [H38] the effect is achieved only when gyroscope is subjected to a non-stationary rotation: on the other hand the experiment of [H27]



seems to be based on the spinning of gyroscope without nutation. In TGD context non-stationarity means that  $Z^0$  magnetic field is not static anymore and induces  $Z^0$  electric field by Faraday's law.

Consider as an example the experiment of [H27]. A rotating gyroscope with the direction of angular velocity same or opposite to that of local gravitational field is studied. The reduction of the weight is reported to be a fraction of about  $10^{-5}$  of the total weight and present for right handed rotation only.

The model for Searl effect could explain this effect although the fact that gyroscope is not magnetized means that the model cannot be identical with that for Searl device.

1. The correlation with the direction of angular velocity is observed also in the case of Searl device and serves as a signature of the importance of classical  $Z^0$  magnetism. The range of  $Z^0$  force is given by the p-adic length scale of dark weak bosons involved. p-Adic fractality suggests that the density of dark  $Z^0$  charge (and also other dark charges) scales as  $1/L^3(k)$  so that above cell length scale the effects due to the dark weak interaction are expected to be weaker than those assignable to gravitation [K8]. Hence  $Z^0$  magnetism need not give rise to the dominant effect.
2. The dark version of the ordinary nuclear magnetism due to the net spin associated with exotic quarks pairs at the ends of color bonds connecting nucleons [K71] could however give rise to long ranged magnetism. In the recent case it could be the dominant effect inducing dark em charging of the device and apparent antigravity effect in the Earth's electric field.

## 4.5 Project Flyaway and Searl effect

## 4.6 Project Flyaway and Searl effect

Marcus Hollingshead has developed a very interesting antigravity device. Unfortunately, there is no published reports about the device, and my information derives only from the email discussions in Antigravity discussion group [H3]. There has been also a heated debate about the claims of Hollingshead. I am grateful for Adrian Panait for generously providing this information. Also the information received from Tim Ventura was very useful. In the following I try to understand the device on basis of TGD based model for the Searl machine and the so called time mirror mechanism (see fig. <http://www.tgdtheory.fi/appfigures/timemirror.jpg> or fig. 24 in the appendix of this book) playing a key role in TGD inspired theory of consciousness and of bio-matter.

### 4.6.1 Description of the device

First a brief description of the device as I have understood by reading the emails. It must be emphasized that these descriptions are highly informal and the only reason that I take them seriously is that the claimed effects resemble those assigned with Searl device.

1. The device consists of six toroidal electromagnets. There is a pair of toroids along each coordinate axes at the opposite sides of the origin and linked around origin. Somewhat like figure eights along each coordinate axis: toroids are however disjoint and free to spin around their own symmetry axis (like a bicycle wheel).
2. The toroids have a steel core surrounded by a "bi-filar" winding carrying alternating currents. According to Marcus Hollingshead: "One winding is pulsed +ve/-ve the other -ve/+ve offset by  $90^\circ$ ". Neither the frequency of the pulsing nor the duration of the pulse are reported but one might guess that the time scale is longer than the time scale defined by  $\tau = 2\pi\sqrt{LC}$ , where  $L$  is the inductance of the second half of the bi-filar coil and  $C$  the capacitance of the entire bi-filar coil. What is clear that the pulsing generates alternating magnetic field inside the toroid.
3. Along the inner surface of each toroid there are 12 smaller toroids in the plane tangential to the toroidal surface. These toroids are also pulsed. The details about how the pulsing depends on the position with respect to  $rp$  are not provided.

4. At the origin there is a charged ball, called reference point (rp). The sign of the charge is relevant for the functioning of the system.
5. During the functioning of the device the large toroids spin around and above the rotation frequency of about 70 Hz weight loss and other effects are reported to appear. The system is reported to lose part of its inertia. During the functioning of the device the temperature in rp and its surroundings is lowered to about 100 Kelvins. The system repulses objects around the system if held at a fixed position. Also the loss of the reflected light from rp occurs and a spherical vacuum of diameter 2.2 meters is generated. The device is contained by a cube of side of length shorter than 1 meter so that the size of the vacuum region is larger than the size of the device.

### 4.6.2 About the bi-filar coils

The characteristic feature of bi-filar coils is that the current returns from the end of the coil and flows through the coil again but rotates in opposite direction. In a stationary situation the ohmic currents flowing in opposite directions around the toroid create magnetic fields cancelling each other in a good approximation. In the recent situation one has however square pulses and for long enough square pulses the magnetic field is present as a transient phenomenon at the beginning and the end of the pulse.

Circuit equations give a good grasp on the situation. In circuit equations inductance corresponds to mass, resistance to a friction force proportional to velocity, and inverse capacitance to a harmonic force. Current corresponds to the position coordinate of the oscillator. Bi-filar coil can be compared to a mechanical system whose mass increases from zero to a maximum value (current has propagated to half way along the coil), drops back to zero in time reversed manner, remains zero for a period determined by the duration of the long enough pulse, and then again raises to maximum and drops back to zero. The increase and reduction of the mass occur with a constant rate in the ideal situation.

If the duration of the pulse is long as compared to the time constant  $\tau = 1/f = 2\pi\sqrt{LC}$  of the circuit, the situation is adiabatic except in the beginning and the end of the pulse. This means that during the initial and final transients the frequency  $\omega = 1/\sqrt{LC}$  of the circuit decreases slowly from a very large value to minimum and increases then back until adiabatic approximation fails. During the middle period when inductance vanishes the system is characterized by its resistance and capacitance and the current decays exponentially with the time constant  $\tau = RC$ . It is plausible that a radiation in a wide range of frequencies is generated during the transients since the mechanical counterpart of the system is harmonic oscillator whose frequency is varied slowly.

A detailed model for what happens discussed in [K82] predicts that  $\tau = RC$  gives an upper cutoff for the frequencies emitted (as one expects on basis of the fact that the cutoff must relate to dissipation and second law). TGD however suggests that the generation of negative energy topological light rays leads to a reduction of the resistance since charge carriers are dropped to larger space-time sheets via the emission of negative energy photons. This raises the upper cut-off frequency and even visible light might be emitted.

During the transients the magnetic field which increases (decreases) linearly as a function of time at the first (second) half of the pulse, and generates a rotational electric field in the direction of the wire of the winding. At the middle of the coil the constant electric field along coil changes its direction. For long enough pulses the rotational electric field drops to zero during the periods when the entire coil is filled by the ohmic current. The displacement current caused by the discontinuous change of the rotational electric field could induce a sharp magnetic pulse in the direction of the toroid's axis unless vacuum currents possible in TGD Universe (see below) compensate it.

Sharp unipolar pulses appear again and again in various free energy technologies inspired by Tesla's discoveries. This forces ask what is so special in sharp unipolar pulses. If one accepts the time mirror mechanism as a manner to amplify negative energy signal to a much stronger positive energy signal, the question transforms to a question how sharp unipolar pulses are able to generate negative energy topological light rays.

The answer comes from the observation that the generation of negative energy topological light rays breaks the second law of thermodynamics in some relevant length and time scale. On the other hand, TGD forces a more precise formulation of the second law. Second law at a space-time sheet

characterized by a given p-adic prime and having thus size given by the corresponding primary or possibly n-ary p-adic length scale holds true only above the corresponding p-adic time scale. Thus if one is able to generate field patterns having a duration shorter than the p-adic time scale in question, breaking of the second law results. In particular, negative energy topological light rays are generated.

In the case of a unipolar pulse the transients at the end points of the pulse are time reversals of each other since electric field grows/decreases at the end points. The transients at the endpoints of the pulse in turn decompose into two parts corresponding to a growing magnetic flux followed by its time reversal. For electric field transients in a good approximation correspond to a rotational electric field which is constant inside the wires followed by its negative when half of the coil is filled by the current. Thus the relevant p-adic time scale must be longer than the transient time in the beginning of the pulse. Two different p-adic time scales might be involved.

What is essential is that charge carriers are accelerated or decelerated during the sharp electric pulses. Deceleration involves a loss of energy by the emission of brehmstrahlung as positive energy photons and acceleration a gain of energy by the emission of negative energy photons. The mechanism works in the case of any pulsed system.

1. In the case of ordinary coils the emission of negative energy photons occurs during the acceleration of the charge carriers at the initial transient of the voltage pulse giving rise to constant electric field. If the duration of the pulse is long enough, charges dissipate their energy and also the second transient at the end of the pulse gives rise to similar emission of negative energy photons.
2. In case of a bi-filar coil the emission of negative energy photons occurs also during the second half of the magnetic pulse when system is in accelerating phase. Therefore there are two time scales involved corresponding to magnetic and electric pulses.

The emission of negative energy photons could involve generation of standing magnetostatic waves in the core of the bifilar coil caused by the currents flowing in opposite directions. The wavelength of the standing wave would correspond to the distance between the wires of the bifilar coil. This suggest that basically same mechanism of remote metabolism is involved as in the case of Searl machine. It is not clear what the intensity of the magnetic fields involved is. The scaling law of homeopathy relates in the case of Searl device 230 Hz frequency to 12 GHz Larmor frequency. Something like this is expected also now.

### 4.6.3 Trying to explain the claimed effects

It is of interest to compare the system to Searl's machine (as I understand it in TGD framework) in order to understand what might be involved. From the highly informal reports (which forces to take the claims with a big grain of salt) one can deduce that all new physics effects involved with the Searl machine are claimed to occur also now.

1. The reduction of the inertial mass.
2. Classical long ranged  $Z^0$  Coulomb force implying as the repulsive force towards objects when the vehicle is not allowed to move.
3. Breaking of the second law of thermodynamic and the reversal of the arrow of geometric in p-adic time scale relevant for the functioning of the system. This is manifested as the lowering of the temperature of rp and the generation of vacuum around the vehicle and by the disappearance of the reflected light.

#### Remote metabolism and lowering of the temperature near rp

The presence of the negative energy photons explains the strange effects associated with the central region.

1. Central region is reported to darken and also a sudden lowering of the temperature is detected. This could be simply due to the fact that negative energy photons act as kind of dark light.

Atoms emitting light are de-excited by the absorption of negative energy photons without any emission so that the emission of light is reduced. The absorption of the negative energy photons also cools the system. In the same manner as positive energy photons heat the system, negative energy photons cool it.

2. The absence of the reflected light from central region is a further strange phenomenon. The first explanation of the absence of reflected light is based on the fact that reflection involves an elastic scattering of the photons of the incoming light beam. This can be regarded as an absorption of the incoming photon followed by re-emission. If negative energy photons are present, the charged particle can return to the ground state by absorbing negative energy photon instead of emitting a positive energy photon. In the language of Feynman diagrams, the outgoing photon is a negative energy photon received from an external source so that no positive energy photon appears in the final state. One could also say that ordinary reflection is replaced with a reflection in time direction.

One can imagine also an alternative explanation for the loss of the reflected light. During the irradiation of rp the photons topologically condense on the space-time sheet of rp. Because there are only few bridges which allow the photons to escape back to the space-time sheet of the environment, the photons fail to find the way out of rp space-time sheet. The loss of the light reflected from rp reminds somewhat of what happens near black-holes although gravitational field has nothing to do with the phenomenon. Now only a "partial" mini-black-hole is in question and the radius of the hole is much larger than the radius of black-hole horizon of rp so that the classical gravitational force has nothing to do with the phenomenon.

In the case of Marcus device the spinning bi-filar coils would serve as sources of negative energy topological light rays identifiable as correlates of phase conjugate laser waves. Also now standing magneto-static waves caused by the currents flowing in opposite directions and having periodicity defined by the distance between the bi-filar wires would be involved. They could be accompanied by negative energy photons. Also negative energy scalar pulses are possible. The adiabatic variation of the time constant of the bi-filar coil indeed generates a wide spectrum of photons. Also bi-photons appear with a constant frequency independent intensity over visible frequency range at least and might be generated by a similar square wave mechanism.

In the biological applications (see the books [K48, K37]) topological light rays are typically parallel to magnetic flux tubes acting effectively as wave guides. The model of EEG leads to the idea that also negative energy magnetic flux tubes possible. This encourages to think that magnetic flux tubes are involved also now. In particular, negative energy magnetic flux tubes acting as wave guides for negative energy topological light rays could be present.

### Could the dropping of charges to larger space-time sheets produce large recoil effects?

It is not plausible that the net momentum of even positive energy photons could explain the motion of the Marcus device. The reason is that the ratio  $pc/E = 1$  of momentum and energy for photons is too small. For non-relativistic particles the ratio is  $pc/E_{kin} = \sqrt{2mc^2/E_{kin}} \gg 1$ . Thus the dropping of ions to larger space-time sheets induced by the bridges formed by the topological light rays could generate large recoil effects.

In many-sheeted space-time particles topologically condense at all space-time sheets having projection to given region of space-time so that this option makes sense only near the boundaries of space-time sheet of a given system. Also p-adic phase transition increasing the size of the space-time sheet could take place and the liberated energy would correspond to the reduction of zero point kinetic energy. Particles could be transferred from a portion of magnetic flux tube portion to another one with different value of magnetic field and possibly also of Planck constant  $h_{eff}$  so that cyclotron energy would be liberated. In [K55] a model of metabolism associating the metabolic energy quantum to the change of cyclotron energy is discussed. In the following only "dropping" option is considered.

Modanese and Podkletnov have found that a radiation pulse, which does not allow an interpretation as an ordinary em radiation, is generated in the discharge of a capacitor for which the second plate is a super-conductor [H43]. Furthermore, this radiation pulse kicks test penduli in motion at large distances and this effect does not weaken with distance which means that it cannot be based on the absorption of radiation. If topological light rays serve only as a control switches

making possible for the charges to leak from atomic space-time sheets to larger ones, this kind of effect becomes possible since the leakage causes a recoil effect kicking the test pendulum.

Thus it would seem that the negative energy topological light rays generated by the bi-filar could induce the dropping of charges at rp to larger space-time sheets, say magnetic flux tubes of the Earth's magnetic field or the magnetic field generated by the system itself. This could generate a large recoil effect in the case that the effects of different toroids do not compensate each other and cause the motion of the device.

The model explains why the ball in the origin must be charged. It is only charged particles which couple to electromagnetic topological light rays and photons and thus can be driven by the transversal electric field of the topological light ray from the atomic or some larger space-time sheets to the magnetic flux tubes of Earth or some other space-time sheets as they receive negative energy MEs compensating the zero point kinetic energy.

Also low frequency MEs are involved. For neutral particles the interaction with the microwave MEs generated by the large toroid (most of microwave MEs comes from the region of toroid nearest to rp) acting as bridges between the two space-time sheets does not cause significant leakage to the large space-time sheets.

### Weight loss and loss of inertia

Also now the strong charging of the system (both em and  $Z^0$  charges could be generated and this process could be induced also now by the radial electric field associated with the rotating magnetic fields. In the recent case microwaves with wavelengths corresponding to the size of rp are required. This suggests that the function of the oscillating current inside large and small toroids is to generate negative energy MEs (also microwave MEs) carrying phase conjugate maser beams of photons. This process provides automatically some kinetic energy and momentum for the large toroid so that the spinning velocity can be varied to control the direction of motion for the system.

In the case of Searl's machine also the ELF frequency associated with the rotation plays the role of critical frequency and also now the spinning frequency (above 70 Hz) is claimed to be significant. The loss of inertia is claimed to be strongest at 70 Hz rotation frequency. In the case of Searl machine the original idea was that a genuine reduction of inertial mass occurs during spontaneous acceleration (pirouette effect) but this idea seems highly implausible in light of the later developments.

### What causes the vacuum around rp?

The first explanation for the vacuum around rp is that the absorption of negative energy photons induces the dropping of charged particles to larger space-time sheets so that they effectively disappear from the system.

The second explanation for the generation of vacuum is as being due to the repulsive classical  $Z^0$  force. All atomic nuclei are completely ionized  $Z^0$  ions and neutrons give the dominating contribution to the  $Z^0$  charge (proton's  $Z^0$  charge is by a factor 1/50 smaller than neutron's  $Z^0$  charge and of opposite sign). Since the ratio  $N/A$  of the neutron number  $N = A - Z$  to the mass number  $A$  does not vary much for the heavier nuclei, the  $Z^0$  force behaves in a reasonable approximation like a strong gravitational force.

Since all nuclei are completely ionized  $Z^0$  ions, whose classical  $Z^0$  field is seen and screened (not completely) by neutrinos in length scales longer than cell size, the spinning of the large toroid generates  $Z^0$  magnetic field orthogonal to the plane of the toroid. This field induces spontaneous  $Z^0$  magnetization inside the small toroids. Since small toroids are rotating with a velocity orthogonal to this field,  $Z^0$  electric field which is directed radially from the center of the large toroid by the same mechanism as the rotating cylindrical magnet generates a radial electromagnetic field.

The rotating  $Z^0$  magnetic field generates a classical  $Z^0$  electric field  $E_Z = v \times B_Z$  (generalized Faraday effect) having non-vanishing  $Z^0$  vacuum charge as its source. This vacuum charge, if it has same sign as the  $Z^0$  charge of Earth and objects around it, implies repulsion and strengthens the antigravity effect (of course, a real antigravity effect is not in question).  $Z^0$  Faraday effect suggests a more plausible explanation: the vacuum electric field associated with toroids induces exotic neutrino current which creates a net  $Z^0$  charge inside the rotating toroid and opposite  $Z^0$  charge in its immediate vicinity. The sign of the  $Z^0$  electric field does not depend on the

direction of spinning since the field is proportional to the square of the spinning velocity and either a reduction or increase of neutrino screening occurs in environment. If reduction is in question, the resulting the  $Z^0$  Coulomb repulsion tends to drive atomic nuclei out. Protons/electrons have much smaller  $Z^0$  charge than heavier nuclei, and the sign of the charge is different from that of neutron/neutrino. Therefore protons should be attracted by the rotating toroid system and electrons repelled. Obviously this is a testable hypothesis.

The claimed "beam field" effects could be explained in terms of the classical  $Z^0$  force. The condensed matter neutrinos screening the nuclear  $Z^0$  charge of the condensed matter and thus stabilizing it, are extremely light (mass estimates are around .1 eV). Hence neutrinos move very quickly in the external  $Z^0$  force and could generate temporary charge non-equilibrium so that the screening fails locally much like electrons in conductor end up to the surface of the conductor and generate charge non-equilibrium. The failure of the screening could induce dramatic effects such as an explosion of the condensed matter and molecular instability. This could explain the claimed knocking of a hole through a thin sheet of copper by the "beam field". In fact, the screening of  $Z^0$  force by neutrinos plays a key role in TGD based model of condensed matter and molecular chemistry. Molecules more complex than  $AH_n$  where  $A$  is an atom heavier than hydrogen and  $H$  is hydrogen atom (hydrogen has a vanishing  $Z^0$  charge and electron's and protons  $Z^0$  charges are small) are not stable in vacuum. This has deep implications concerning the understanding of the pre-biotic evolution.

## 4.7 More about magnetic motors

Usually the free energy devices do not work but Muammer Yildiz has developed a magnetic motor that works if one is ready to believe that the public demonstrations (for the demonstration at the university of Delft see <http://www.youtube.com/watch?v=mI3227d5C5s> and for Expo 2013 demonstration see <http://www.youtube.com/watch?v=CDpKqdcDDrQ>). The device has been patented (see <http://www.bsmhturk.com/images/documents/W02009019001A2.pdf>).

One cannot of course exclude very clever cheating (someone has proposed Lithium batteries but probably it is easy to exclude this kind of explanation). Professionals [H21, H16] (see [http://peswiki.com/index.php/Article:\\_352B\\_Reasons\\_Why\\_I\\_Think\\_Yildiz'\\_Magnet\\_Motor\\_Really\\_Works](http://peswiki.com/index.php/Article:_352B_Reasons_Why_I_Think_Yildiz'_Magnet_Motor_Really_Works) and <http://nexusilluminati.blogspot.fi/2013/06/introducing-yildiz-magnetic-motor.html>) are not able to point out any fraud.

I am certainly not a professional in these matters but the motor brings in my mind strongly the rotating magnetic systems (much analogous to the so called Searl device) studied by Russian researchers Godin and Roschin [H49] and the model that I developed [K4] to explain the claimed spontaneous acceleration of the system. In the following I make the optimistic assumption that the motor indeed works without any standard power source, and try to explain the situation with inspiration coming from TGD inspired view about Tesla's cold currents [K90] based on dark matter identified as a hierarchy of phases of matter with nonstandard value of Planck constant coming as  $h_{eff} = nh$ , and the notion of magnetic body carrying Bose-Einstein cyclotron condensates of dark charged particles. These notions are also central in TGD inspired quantum model of living matter and I have proposed that magnetic body serves as a universal storage of metabolic energy wherefrom it can be obtained by sending negative energy dark photons or wherefrom it can be fed to the system. If this vision is on right track then Yildiz's magnetic motor would be the first quantum motor based on macroscopic quantum coherence.

### 4.7.1 Observations

On basis of demonstrations Jorge L. Duarte from Electromechanics and Power Electronics Department of Electrical Engineering Eindhoven University of Technology, The Netherlands [H21] and Sterling D. Allan [H16] (<http://nexusilluminati.blogspot.fi/2013/06/introducing-yildiz-magnetic-motor.html>) to make the following observations about the magnetic motor of Yildiz.

1. The motor runs for more than four hours in the demonstration at Expo 2013. After that the motor broke down: this might give some hint about what is involved. No fraud has been discovered. I am not competent to say anything about this so that I chose to believe the word of professionals.

2. The ordinary motor rotator stops without external power source because of dissipation. Radiation losses, ohmic dissipation, and friction cause dissipation so that idle motion requires some power feed. In particular, ohmic eddy currents of electrons in rotor/stator caused by the interaction with the magnetic field of stator/rotor should be present in ordinary magnetic motor and cause heating. Now only a small heating of bearings is claimed to be present by Duarte and Allan.
3. The motor accelerates to about 2000 rpm spontaneously when brake is not on as if there were a continual power feed from unidentified source. As the motor is stopped, the noise produced by it increases. One might interpret this by saying that part of the power feed is transformed to sound waves and heat.
4. The power of the motor is from a second source 240 W when there is no load.

### 4.7.2 Explanation for the absence of eddy currents

Suppose that one accepts the reported absence of heating due to eddy currents. The conclusion of skeptic would be that the rotor cannot be a conductor: this would prevent formation of eddy currents in it. Eddy currents on stator are not formed if also stator is not conductor. This leaves only the fraud as an option.

In the many-sheeted space-time of TGD Universe TGD one can consider also alternative option. The magnetic fields of both rotor and stator could reside at different space-time sheets than usually. If these sheets correspond to magnetic body carrying dark matter realized as phases with large value  $h_{eff} = n \times h$  of Planck constant the eddy currents are replacement by non-dissipating supra currents consisting of dark electron Cooper pairs.

Dissipating eddies could be replaced with single large non-dissipating eddy: electrons would rotate with constant velocity around the magnetic field. The vanishing dissipation is guaranteed if the net Lorentz force and hence dissipation due to the work done by the net force vanishes for electrons:

$$E + v \times B = 0 \quad . \quad (4.7.1)$$

This assumption is made in the simple model of Faraday disk and implies that a radial electric field (in cylindrical coordinates) is generated. What is remarkable that the electric field would *not* be constant and would give rise to a non-vanishing and constant charge density  $\sigma = \omega B$ . As I started developing view about differences between Maxwellian and TGD based electrodynamics, the surprising observation was that there was no explanation for the charge density whose sign depends on the direction of rotation in Maxwellian theory. My original proposal was the the charge density can be seen as purely geometric vacuum charge density. Quantum classical correspondence however requires that it can be also understood in terms of real particles. In any case, the presence of  $E = vB$  inside rotor and the net charge density generating it is a testable prediction and a clue as one tries to understand the mechanism generating the rotation.

In TGD framework this kind of electric field emerges as a simple deformation of space-time surface representing constant magnetic field (not globally since the decomposition into flux tubes (topological field quantization) is unavoidable). Space-time surface would be of form  $X^4 \subset M^4 \times S^2 \subset M^4 \subset CP_2$ , where  $S^2$  is geodesic sphere of  $CP_2$ . Using standard spherical coordinates  $(\Theta, \Phi)$  for  $S^2$  the representation of the space-time surfaces in terms of cylindrical coordinates for space-time is

$$\Theta = f(\rho) \quad , \quad \Phi = \omega_1 t + n\phi \quad . \quad (4.7.2)$$

The simplest space-time surfaces for which  $B$  is constant corresponds to  $\partial_\rho \sin(\Theta) = \text{constant}$ . Lorentz force vanishes if the rotation frequency satisfies  $\omega = \omega_1$ .

This would make possible almost perpetual mobile property. Eddy currents would not dissipate energy and motor could run for a long time. This is of course not enough: the coupling of dissipating load requires power feed. Also the fact that the motor starts to rotate spontaneously indicates the there is power feed.

Note that in TGD Universe the magnetic fields associated with the flux tubes could carry magnetic monopole fluxes and this would guarantee their stability. In fact, this is actually favored by some arguments and there is now some evidence for monopole like systems in condensed matter. Amusingly, the Yildiz has christened his motor as "monopole".

### 4.7.3 AC or DC motor cannot be in question

In various kinds of AC and DC motors torque is in the direction of the rotation axis and in the case of induction motor results from torque associated with Lorentz force and in the case of torque motor from the torques experienced by magnetic moments associated with the parts of rotor in the magnetic field of stator. There are very many different kinds of AC and DC motors as one learns from Wikipedia, and as a non-professional I can represent only a couple of examples which seem to be difficult to imagine.

1. DC or AC power source would be required. Inside the motor only DC source can be imagined. In DC motor a commutator changing periodically the direction of the current associated with rotor is needed in order to have rotation. It is difficult to imagine anything like this.
2. AC motor does not seem plausible since no connections to the external world are present. In any case, in AC motor the AC current - 3-phase current typically - is applied to the stator to make them electromagnets. The magnetic field produced by stator is in first approximation orthogonal to the rotation axis. The current wires running almost vertically along the cylinder defining the rotor. The rotating magnetic field of stator induces a vertical currents in rotor experiencing Lorentz forces which gives rise to torque in the direction of rotation axis. In torque motor the rotating magnetic field of stator generates a torque on rotor which can be a permanent magnet.

It seems that there must be some non-standard power feed into the motor from outside if internal power source is excluded: the only possible option is battery of some kind and in this case DC type motor would be necessary.

### 4.7.4 What could be the source of power and angular momentum?

The fact that the motor accelerates from rest spontaneously to 2000 rpm when brake is off, requires a feed of energy and angular momentum to the system. Standard mechanism of angular momentum feed (torque) are excluded so that one must consider a seemingly "wireless" angular momentum feed. The energy could come from somewhere spontaneously or must be extracted from somewhere.

#### Magnetic body as the storage of energy and angular momentum

In TGD Universe the mechanism could be the same as I have proposed in the case of living systems and also in the case of rotating magnetic system studied by russian researchers Godin and Roschin [H49]. The magnetic body of the system consisting of flux quanta would serve as a storage of energy and angular momentum as proposed in [K90].

1. The system feeding the energy to the magnetic body of rotor could be the magnetic body of the stator or possibly the magnetic body of stator coupled to a larger magnetic body, say that assignable to Earth. If the magnetic body of the stator is involved, one could understand why the stator is necessary. In the case of Godin's and Roschin's rotating magnetic system the role of stator is taken by the cylindrical inner magnet and the role of rotor is taken by "rollers" rolling along the stator magnet.
2. If the external magnetic body contains cyclotron Bose-Einstein condensate with all Cooper pairs with angular momentum and spin in same direction, it serves as a storage of both angular momentum and energy. If the value of Planck constant is large, also the unit  $\hbar$  of angular momentum is scaled up to  $\hbar_{eff} = n\hbar$ .
3. If this kind of system is coupled with the rotor's magnetic body, a natural expectation is that both energy and angular momentum flow spontaneously to the rotor's magnetic body



and forces the dark electron Bose Einstein condensate to rotation. This in turn would force the rotor to rotate and a brake would be needed to prevent this. The situation would be analogous to a flow of heat from higher to lower temperature or the establishment of thermal equilibrium via the flow of energy to degrees of freedom originally at rest.

There are several options for how the angular momentum could be transferred to the rotor.

Skeptic can ask what happens when the orientation of the motor is changed? Can one imagine that the Bose-Einstein system behaves as a single gigantic spin and that its spin is measured in this process so that one has spin eigenstate with new quantization axes parallel to the new rotation axis? Or does it remain the same so that the torque to the motor remains vertical. What would happen to the motor if the directions of the two axes are not same: could a "wrong" direction of torque explain the breakdown of the motor in EXPO 2013?

Note that the rotation velocity of about 2000 rpm corresponds to a rotation frequency  $f = 33.3$  Hz which is in EEG range: this need not be accident and suggests that the size of the layer of magnetic body involved is large: 7.8 Hz corresponds to the Earth's circumference.

### Three options for the transfer of energy and angular momentum

One can imagine three options for the transfer of the angular momentum to rotor.

1. Option I: The angular momentum transfer could take place via a feed of photons with fixed polarization direction resulting when the angular momentum of the cyclotron states is reduced by emission of photons. The fixed polarization direction could be due to a phase transition taking place for the cyclotron Bose-Einstein condensate. The spin direction of the Bose-Einstein condensate should be vertical in the case considered.

Zero energy ontology (ZEO) allows to consider also an option in which the system needing metabolic energy sends negative energy to the magnetic body as dark photons. Now these dark photons would carry also angular momentum in direction opposite to the direction of rotation.

2. Option II: Electronic Cooper pairs from cyclotron Bose-Einstein carrying large angular momentum flow to the magnetic body of the rotor. If the rotor and its magnetic body form a rigid body like system, the rotation of electrons at the magnetic body forces the rotation of the rotor. Basic testable prediction is generation of electric charge to the magnetic body of the rotor. An attractive identification is as the source of the radial electric field implied by  $E + v \times B = 0$  condition. This would fix the charge density to  $\sigma = \omega B$  in suitable units allowing to get rid of dielectric constant of vacuum.

This would predict a force in the electric field of Earth tending to reduce the effective weight of the rotating system. This was observed by Godin and Roschin. The limiting value of rotation velocity would be determined by the rate of dissipation and the current of electron Cooper pairs to the magnetic body of the rotor

Quantum classical correspondence suggests that that the radial electric field  $E = vB$  implied by the vanishing of Lorentz force at magnetic flux sheets is created by the negative charge density. Note that this fixes the direction of rotation and one cannot select it arbitrarily. This prediction is testable.

3. Option III: The rotor itself as a conductor provides the electrons to the magnetic body where they suffer a phase transition to a dark cyclotron Bose-Einstein condensate with large net angular momentum due to the fact that all electron Cooper pairs have same angular momentum. By angular momentum conservation the rotor must develop opposite angular momentum. This is certainly the nice feature of the model. This should have lower ground state energy than the normal state so that the surplus energy could be transformed to the rotational energy of the rotor. Why this should be the case is far from obvious.

If the magnetic body has much larger size scale as the experiments of Godin and Roschin [H49] suggest, the rotor would develop a large *positive* charge and if it can be regarded as a system separate from its magnetic body experiences an electric force in the Earth's electric field (due

to positive charges of air and negative charges of the Earth's surface) increasing effective strength of gravitational force.

To explain the reduction of weight claimed by Godin and Roschin the Bose-Einstein condensate should consist of positively charged particles rather than electrons and the rotating magnetic system should develop a net *negative* charge. Protons are the first option that comes in mind but it is difficult to imagine how the rotor could provide the protons making possible to form this Bose-Einstein condensate.

A more radical but not very plausible option is that electrons and positrons are generated spontaneously from dark bosons with large Compton length but energy of order two electron masses. One could couple the production mechanism to an old anomaly of particle physics [K79]. Dark variants of so called lepto-pions observed in high energy nuclear collisions and serving as analogs of ordinary pions might be in question. Coherent states of lepto-pions could be produced in very strong non-orthogonal electric and magnetic fields varying considerably in the Compton time scale of lepto-pion, which for dark lepto-pion would be scaled up by  $n = h_{eff}/h$ . The decays of electro-pions would in turn produce dark electron-positron pairs.

4. Option IV: Charged particles from the rotating system are driven by centrifugal acceleration to the magnetic body of the motor to large  $h_{eff}$  phase which suffers spontaneous magnetization. The large spin interaction energy proportional to  $h_{eff} = n \times h$  is negative so that the rotating system gets a compensating rotational energy. The large spin (the unit of spin is proportional to  $h_{eff}$  compensates the angular momentum of the rotating motor. Hence conservation laws are respected. Dissipation requires transfer of charged particles to the magnetic body so that the motor cannot act like perpetuum mobile and the best one can hope is that it acts as a long-lived battery easy to restore.

To sum up, it seems that Option III is too science fictive. Option I is perhaps too complex and does not explained the claimed reduction of effective weight so that Options II and III remain the best candidates.

### Constraints from the observations of Godin and Roschin

The model allows at least two options corresponding to the the transfer or polarized dark photons and dark electron Cooper pairs to the magnetic body of the rotor as the mechanism of acceleration. If one takes the report of Godin and Roschin [H49] seriously, one can distinguish between these models in favor of dark electronic Cooper pairs. The additional prediction would be effective reduction of gravitational force which however has nothing to do with gravitation.

In the case of rotating magnetic system studied by Godin and Roschin the formation of cylindrical magnetic walls with thickness of about 5-10 cm, distance of order 50 cm, and up to distance 10 m at least have been reported as also ionization of the surrounding air causing emission of visible light and presumably caused by electron currents from the surface of the rotating system associated with the dielectric breakdowns in the surrounding air. Also reduction of the temperature of surrounding air is reported. In the recent case similar phenomena might be observed. A good guess is that dark photons possibly involved should have wave lengths of 5-10 cm *resp.* 50 cm corresponding to frequencies of order 2-1 GHz *resp.* .1 GHz.

One gets additional constraints on the model if one takes seriously the loss of weight of the rotating magnetic system with weight of order 100 kg is reported by Godin and Roschin. As a matter of fact, the option II in which the flow of electron Cooper pairs to the magnetic body of rotor forces the rotation is selected.

1. The obvious explanation for the effective reduction of gravitational force is that the system develops a large negative charge which induces a vertical force in the Earth's electric field which is about 100 V/m. To have a force pointing upwards and corresponds to the gravitational force for object of 10 kg, negative charge of .1 Coulombs would be needed. Electrons are indeed the correct option and the charge of .1 Coulombs corresponds to  $N = 6 \times 10^{17}$  electronic charges. The explanation for the negative charge could be in terms of cyclotron Bose-Einstein condensate of electronic Cooper pairs at magnetic flux sheet bound to the rotating system. Since all electron Cooper pairs would rotate in the same direction in the

Bose-Einstein condensate would force the system to rotate if the magnetic body is fixed rigidly to the visible matter part of the system.

2. The net charge should be consistent with the net charged density of the magnetic body equal to  $\sigma = \omega B$ . This allows to deduce an estimate for the size of the magnetic body of the rotor. One can express the charge as electric flux over the surface of magnetic body as  $Q = \epsilon_0 \int E dS = (\epsilon_0 \hbar / e^2) \int v e B dS / \hbar$  and use magnetic flux quantisation  $\int e B dS = m \hbar_{eff}$ ,  $\hbar_{eff} = n \hbar$ . Assuming that  $v$  is constant, parallel to surface and orthogonal to  $E$  at the surface, one obtains the estimate

$$N = \frac{Q}{e} \simeq \frac{1}{4\pi\alpha} \frac{v}{c} m n, \quad \alpha = \frac{e^2}{4\pi\epsilon_0 \hbar c} \simeq \frac{1}{137}. \quad (4.7.3)$$

This gives

$$m n \simeq 4\pi\alpha \frac{c}{v} N \sim 5 \times 10^{17}. \quad (4.7.4)$$

3. The total angular momentum of the Bose-Einstein condensate would be for  $N = 6 \times 10^{17}$  electrons with cyclotron angular momentum  $j$  and effective value  $\hbar_{eff} = n \hbar$ ,  $\hbar \simeq 10^{-34}$  Js of Planck constant given by

$$J = N j \hbar_{eff} = 10^{17} \hbar. \quad (4.7.5)$$

Rather remarkably,  $J/\hbar \sim 10^{17}$  is rather near to the previous estimate  $nm = 5 \times 10^{17}$  suggesting that the value of magnetic flux using  $\hbar_{eff}$  as unit should be roughly the same as the value of angular momentum using the same unit. Using the expression for the flux as rotation of gauge potential  $A$  this condition would correspond to the familiar quantisation condition  $\oint (p - eA) \cdot dr = 0$ .

In macroscopic units one has  $J = 10^{-17} n j$  Js. A rough order of magnitude estimate for the angular momentum  $L$  of a cylindrical object with mass  $m = 10$  kg and radius of  $R = .5$  m rotating with frequency  $f = 10$  Hz is  $L = I\omega = mR^2\omega/2 \sim 17$  Js.  $nj$  should be of order  $10^{17}$ . This illustrates how incredibly small angular momentum  $\hbar$  corresponds to.

4. Both  $j$  and  $n$  can be large. For  $j = 1/2$  (the worst case with no cyclotron angular momentum) one would obtain  $n \sim 2^{58}$ .  $j$  is expected to be rather large: if electrons move around circular orbits of radius .5 meters with relativistic velocity and thus mass  $m/\sqrt{1-v^2/c^2}$  the estimate for orbital angular momentum is  $l \sim Ecr > mcr \sim 3 \times 10^{12} \hbar$  so that the estimate for  $n$  is scaled down to  $n \sim 2^{10} \simeq 10^3$ . TGD inspired model for living matter predicts much larger values of Planck constant and mildly suggests that preferred values of  $n$  come as powers of  $2^{11}$ .

The first guess for the cyclotron frequency is as the rotation frequency 2000 prm, which corresponds to  $f = 33.3$  Hz and is in EEG range. In the case of electron this would mean very weak field of order  $B = 2 \times 10^{-4} B_E \simeq 4$  nTesla (the nominal value of the Earth's magnetic field is  $B_E = .5$  Gauss). For  $B_E$  electron's cyclotron frequency would be much higher, about 2 MHz corresponding to photon wavelength  $\lambda = 150$  m. For  $Ca^{++}$ , which is boson and whose cyclotron Bose-Einstein condensates are of fundamental importance in TGD inspired model of living matter,  $f$  would correspond to a field value consistent with  $B_E$ . Could the motor couple to a  $Ca^{++}$  cyclotron BE condensate assignable to magnetic Mother Gaia? The strange effects of radiation on vertebrate brain - the starting point of TGD inspired model of living matter - can be understood if  $Ca^{++}$  BE condensate at the flux quanta of magnetic body with field strength  $.4B_E$  is present.

Cyclotron frequency would be in this case 15 Hz rather than 33.3 Hz. Can one therefore conclude that magnetic Mother Gaia is involved?

Interestingly, in the system of Godin and Roschin the frequency was 10 Hz, the fundamental biorhythm allowing also interpretation as cyclotron frequency for certain ions. If the Earth's magnetic field is involved then the magnetic field at connecting flux tubes should be rather weak: about .5 Gauss and much weaker than the nearby magnetic field of the magnets inside the motor. The magnetic field along flux tubes can weaken at larger distances since only the flux is conserved and weakening would be analogous to what happens in a tube containing liquid flow as it thickens.

### Cyclotron phase transitions and "motor actions" of magnetic body

I have talked about cyclotron phase transitions as processes liberating or extracting somewhere energy assignable to dark photons with cyclotron energies. This kind of phase transition could also accompany the energy transfer from the magnetic body of the rotor to the rotor. I have however not specified what happens in this kind of phase transition and how it correlates with the classical dynamics of the magnetic body: quantum classical correspondence certainly requires this kind of correlation.

The following argument suggests that magnetic "motor action" identifiable as a temporal increase (reduction) of local magnetic fields strength by thinning (thickening) of the magnetic flux tube is a natural classical space-time correlate for the cyclotron phase transition emitting positive (negative) energy cyclotron photons.

1. Suppose that the cyclotron Bose-Einstein condensate is in population reversed state so that energy is same for all bosons (possibly Cooper pairs of fermions) and corresponds to a fixed value of harmonic oscillator quantum number  $n$ . Spontaneous single particle transitions can only reduce the cyclotron energy (value of  $n$ ).
2. By the Golden Rule of time dependent perturbation theory, the transitions induced by a perturbation lasting for a finite time *conserve energy*. Since system's dynamics is not time invariant, the conservation of energy is not obvious and reflects the assumption that the duration of perturbation is much shorter than the time interval considered. Basically, the implicit assumption that energy resolution is actually finite and that perturbations are limits of exponentially increasing perturbations at the limit when exponent  $\alpha > 0$  in  $\exp(\alpha t)$  approaches zero and that  $t \ll 1/\alpha$  holds true in the limiting process.

In TGD framework causal diamonds (CDs) realize this kind of non-ideal situation at the level of fundamental theory. There are two resolutions: IR resolution and UV resolution. The finite energy resolution corresponds to  $\Delta E = h_{eff}/T$ ,  $T$  the distance between the tips of CD assignable to the observer. The finite time resolution  $\Delta T$  corresponds to the minimum size of CD. If the duration of the time dependent perturbation is below  $\Delta T$ , energy conservation holds true for observer CD since the perturbation correspond to CDs below measurement resolution and are interpreted as quantum fluctuations in ordinary QFT. By quantum criticality of TGD Universe, this kind of small scale quantum fluctuations can however induce (energy conserving!) phase transitions in longer time scales.

3. Golden Rule in the recent situation suggests that a momentary increase of the strength of the local magnetic field strength in population reversed state must generate cyclotron radiation. Without this transition cyclotron energies of particles would increase in conflict with energy conservation so that the only possibility is to perform quantum jump to a lower energy state and emit energy. The transition amplitude for a transition in which each boson makes quantum jump independently is small since the amplitudes sum up and tend to interfere to zero. If all bosons make the same transition, constructive interference occurs and the transition amplitude is proportional to the number  $N$  of bosons and the rate therefore proportional to  $N^2$ . Therefore phase transition occurs.

If the magnetic field is reduced by expanding the flux tubes, the system is expected to generate negative energy cyclotron photons to guarantee energy conservation via cyclotron transition increasing the value of  $n$ . Therefore the two fundamental cyclotron phase transitions would correspond at space-time level to "motor activities" of the magnetic body. These motor

activities could be very relevant in living matter and perhaps also in some free energy systems, such as magnetic motors.

4. The temporary increase of magnetic field strength possible by a quantum jump to a state in which classical dynamics of typical flux tube in quantum superposition gives rise to a temporary reduction of thickness of the flux tube and by flux conservation increases the field strength locally. The failure of strict determinism for Kähler action gives good hopes for the realization of the basic magnetic motor actions as preferred extremals of Kähler action.

#### 4.7.5 A TGD inspired model for Yildiz motor

The following represents a TGD inspired model for Yildiz motor. The model relies crucially on the notion of magnetic body and the possibility of magnetic flux tubes carrying monopole flux and requiring no currents to generate them. They are made possible by the nontrivial topology of  $CP_2$  reflecting as non-trivial topology of space-time sheets.

The idea is to create a situation in which constant torque is created and forces the motor to accelerating rotation. The system cannot achieve state in which torque vanishes unless either or both magnets loses its magnetization. This is however prevented by the basic property of ideal permanent magnets.

1. This kind of situation emerges if rotor and stator generate rotationally invariant magnetic fields, which are orthogonal to each other and in a plane orthogonal to the rotation axis (call it z-axis) in the volume occupied by rotor. They can have also z-component outside the rotor volume. There are two kinds of magnetic fields satisfying the rotational symmetry. In the first case the magnetic flux lines are radial (orthogonal to z-axis) and in the second case they rotate around z-axis. The magnitude of the field is invariant under rotations around z-axis.

One can assume that the magnetic flux of rotor rotates around z-axis along circles and that the magnetic field of the stator is radial in the region of rotor. One can consider also the possibility that rotor corresponds to the radial field and stator to a rotational field orthogonal to it.

2. Consider now the torque generated to the rotor. A small volume element of the rotor corresponds to a small magnetic dipole  $d\mu = M_{rot}dV$  where  $M_{rot}$  is the local magnetization density of the rotor proportional to the local magnetic field created by the rotor. The magnetic field of stator creates a torque  $d\tau = d\mu \times B_{stat}$  which is in the direction of z-axis and same for all volume elements of same volume  $dV$ . Hence a net torque is generated has magnitude  $\tau = M_{rot}B_{stat}V$ . The torque is constant and induces accelerating motion which begins spontaneously. Dissipation, in particular that associated with the bearings, implies some limiting rotational frequency. This picture conforms with the fact that the Yildiz motor must be prevented from rotating by using a brake and the motor starts to rotate spontaneously.
3. It is not possible to achieve vanishing torque unless something happens to the magnets or magnetic fields created by them. One possibility suggested by standard physics is that the magnetic energy of the magnetic fields is transformed to energy to compensate the dissipative losses of the rotational energy. This can be achieved if the microscopic magnetized patches of the rotor magnets turn so that they become parallel to  $B_{stat}$  and actually rotate with the same frequency as rotor itself so that dissipation gradually slows down the system. If there is sufficiently strong magnetic interaction stabilizing the magnetization of the rotor magnet this does not happen: this is actually true almost by definition of the permanent magnet. The conservation laws of energy and angular momentum must hold true, and in the world of standard physics it seems that the magnetization of rotor or possibly stator must gradually weaken in order to compensate dissipative losses.
4. In TGD Universe the magnetic body of the rotor and stator or both (even larger magnetic bodies) could however come in rescue to guarantee conservation laws. The compensating angular momentum could be generated at the magnetic body of the rotor and correspond to the angular momentum of dark supra currents rotating around the z-axis. The energy compensating for dissipation and load must be also extracted from some source and could come

either from the phase transition liberating cyclotron energy of the Bose-Einstein condensate associated with the flux quanta. Also magnetic energy could be liberated.

The general mechanism involving phase transition in which  $h_{eff}$  is reduced - say to its ordinary value  $h$  - by a power of 2 and p-adic prime  $p$  of the flux quantum is increased so that the volume remains same but the scale of cyclotron energies is scaled down by factor  $2^{-k}$  would liberate almost total cyclotron energy. If rotor is coupled rigidly to the magnetic body, the rotation of the magnetic body forces the rotor to rotate. It is quite possible that flow of both dark Cooper pairs and dark photons from larger magnetic bodies to the magnetic body of rotor takes place. Of course, a continual flux of energy to the magnetic body in question is required and here the flux of dark photons could induce the reverse phase transition back to the dark phase. The alternative mechanism involves flow of the dark electron Cooper pairs from larger magnetic body to that of rotor replacing the electrons, which probably are not Cooper pairs anymore.

Therefore the magnetic bodies are forced to accept the fait accompli and do their best to pay the energy and angular momentum bill.

How to produce the needed magnetic fields?

1. The magnetic field of rotor could be produced by using circular magnets obtained by prising bar magnet to circular magnet by connecting its ends. One can assume that the bar magnet has the form of plate so that one obtains an annulus. By piling up these annuli one obtains a cylindrical structure.
2. The radial magnetic field of stator could be realized by arranging bar magnets in radial direction with say N-pole directed outwards. The repulsion between the S-poles of the radial magnets challenges the mechanical stability of the system: this might explain why the motor broke down in the Expo 2013 demonstration. The radial magnets could be constructed so that they are thickened in radial direction and therefore touch each other over their entire length. This would be needed to prevent return flux along the sides of the bar magnets.

The magnetic field corresponds effectively to the field of magnetically charged wire. This probably motivates the name "Monopole" used by Yildiz about his motor. A real monopole field is not in question: see below. To achieve effective monopole field the annular rotor magnets must be sufficiently near to the stator magnets in the region closed by the rotor.

This looks too good to be true and one must try to invent objections.

1. Consider first the magnetic field of the rotor. The flux rotates around z-axis along annulus and is therefore rotational. Second non-topological half of Maxwell's equations implies that  $\nabla \times B_{rot}$  is proportional to the sum of the time derivative of electric field and current. In stationary situation the time derivative of the electric field vanishes and the current can be said to generate  $B_{rot}$ . For instance, the current could be a surface current rotating around the annular magnet.

In TGD Universe the non-topological half of Maxwell's equations is replaced by conservation laws for energy, momentum, and color charges and this problem can be circumvented. If the magnetic fluxes are monopole fluxes no current is needed to generate  $B_{rot}$ . This means the 2-dimensional cross section of the flux tube is closed 2-surface rather than disk as in Minkowski space. This kind of monopole fluxes are predicted by the non-trivial second homology of  $CP_2$ .

In fact, all elementary particles in TGD Universe correspond to monopole flux loops associated with a pair of space-time sheets connected by wormhole contacts. The first flux tube connects the "upper" throats of the contacts and second flux tube connects the "lower" throats of the contacts.

This mechanism explains also why Universe is filled with magnetic fields in even cosmological scales. Maxwell's theory would require currents to generate them and in the early cosmology it is extremely difficult to imagine this kind of currents in long length scales. If the fields correspond to monopole fluxes no generating currents are needed and the problem disappears. In fact, primordial TGD Universe consists of extremely thin string like space-time sheets

(“cosmic strings”) carrying monopole fluxes and the astrophysical magnetic fields in the recent Universe are their remnants.

There are also indications that monopole like magnetic fields appear also in condensed matter physics. In fact, permanent magnets could create monopole magnetic fluxes whereas electromagnets would generate topologically trivial magnetic fields.

2. In the case of stator magnetic field return flux poses potential problems in Maxwell’s theory. The flux should not come back along the sides of the bar magnets (the net torque would vanish in this case!) but must return through the region inside the rotor cylinder, say along  $z$ -axis as in the case of Dirac monopole. Since in TGD framework the flux is restricted inside flux tubes, the problem disappears if the flux tubes can be forced to return through the interior of the rotor cylinder.
3. The third objection is that the torque forces microscopic magnetized regions to oscillate around their equilibrium positions because the neighbors of given microscopic region generate compensating magnetic moment when the deviation from equilibrium is large enough. The magnetic energy and angular momentum feed would be dissipated to heat. Whether this happens can be clarified only by experimentation.
4. The fourth objection is that rotor might experience only the average magnetic field through its net magnetic moment. Both these vanish for rotational symmetry. If this is indeed the case, the rotor magnet must be constructed as a half-circle. In this case the total magnetic moment is tangential to the middle point and the average magnetic field in the volume of the rotor magnet is along the radial line through this point. Mechanical equilibrium is guaranteed if the mass of the second non-magnetic half circle is same as the mass of the magnetic part. One can also arrange the layers so that they are rotated with respect to each other by some angle which is multiple of  $2\pi/N_{layers}$ , where  $N_{layers}$  is the number of layers, so that that average mass distribution is rotationally symmetric.
5. A further objection is that the flux of the stator magnet (ring magnets with radial flux are manufactured) is so strong that it turns the magnetization of the rotor magnets to radial direction so that torque vanishes. Especially if the magnetic flux is along magnetic flux tubes of constant thickness and quantized it can do this. The magnetic fields tolerated by ferromagnets are at most of the order of Tesla so that this might happen. It seems that diamagnetic materials are not needed in the construction to guide the radial flux. Their critical field is at most about .1 Tesla.
6. The last objection is that the construction of the motor could generate strong mechanical tensions in the structure and the energy liberated from these could provide the energy needed for rotation. An old fashioned clock in which energy is stored to spring, serves as an analogy. If the power used to overcome dissipation is 240 W, four hours of continual rotation in Expo 2013 would use energy of  $.240 \times 4 \times 3600 \text{ J} \simeq 3.6 \text{ MJ}$ . This energy would allow to lift 1 kg weight to the height of 360 km. It is difficult to imagine how the structures could store so high an energy.

The key objection relates to the energetics. The kinetic energy and angular momentum energy could be transferred from some bigger magnetic body - say that of Earth. In the rotating magnetic system studied by Russians cooling of the surrounding air was reported which suggests that the system is able to emit phase conjugate photons with negative energy absorbed by atoms. Energies would be in eV range.

One can consider also the option in which no energy feed from outside is involved so that system itself would be able to liberate the needed energy associated with some degrees of freedom. The findings of Pollack [?] suggest a possible mechanism. Pollack found that when water receives energy - say by irradiation with visible light - it generates negatively charged regions - exclusion zones- with the stoichiometry  $H_{1.5}O$ . The natural interpretation in TGD framework is that part of protons are driven to the magnetic body associated with the EZ and are transformed to dark protons with large value of Planck constant so that the cyclotron energies are in visible range. The resulting voltage makes the system the analog of battery and it could define a primitive life form.

The sum for the differences of Coulombic and cyclotron energies at the portions of the magnetic flux tube inside and outside EZ defines the liberated energy in the general case. One ends up to a quantum metabolism in the case of cell membrane by applying zero energy ontology (ZEO).

In the recent case one can consider following scenario.

1. Charged particles from the rotating system are driven to the magnetic body of the system - most naturally by centrifugal acceleration. They are transformed to dark particles so that the cyclotron energy is scaled by  $h \rightarrow h_{eff} = n \times h$  scaling cyclotron energy to the range of visible and UV radiations if the same assumption that dark photons have energies of biophotons holds true quite generally. This means that the spin interaction energy with the magnetic field is in eV range and very large.

This leads to a spontaneous magnetization of the magnetic body. Since the interaction energy is negative the outcome is liberation of energy. Part of it goes to the rotational motion of the motor. Part of the energy could become elastic energy and generate tensions in the system: this might explain the tendency of the system to break down. Spontaneous magnetization generates large angular momentum at the magnetic body since the unit of spin is now  $h_{eff}$ . This angular momentum is compensated by the angular momentum of the rotating system. If this mechanism is realized, the motor can work only finite time. The transfer of the particles from the magnetic body back to the motor would require energy so that the system could only serve as the analog of battery.

2. This mechanism could in living matter involve formation of Cooper pairs with the members of the pair at neighboring flux tubes carrying parallel fluxes. The spin-spin interaction energy is negative and large if the spins are in  $S = 1$  state and thus parallel. The resulting high  $T_c$  superconductivity could have very high critical temperature since Cooper pairs are stable up to thermal energies of order eV.
3. The mechanism could be at work also in the rotating magnetic system studied by Godin and Roschin. In this case the system is highly charged, which suggests that either protons or electrons are transferred to the magnetic body.

Concluding, the construction seems to work only in TGD Universe thanks to the possibility of homological magnetic monopole fluxes, due to the topological flux quantization in many-sheeted space-time, and the notion of magnetic body.

#### 4.7.6 Cautious conclusion and questions

The cautious conclusion is that the options II and II define models able to explain qualitatively both the claims of Roschin and Godin and the behavior of the magnetic motor of Yildiz. For option II there would be a feed of dark electronic Cooper pairs to the magnetic body of rotor and forming a cyclotron Bose-Einstein condensate at magnetic bodies involved with the Earth's magnetic body possibly included. The rotation begins spontaneously if there is a rigid coupling between the rotor and its magnetic body. One can understand both the observed very low dissipation and spontaneous acceleration and the quantum model is consistent with the classical model based on the vanishing of Lorentz force and predicting non-vanishing charge density. The rotation is predicted to occur only in one direction. An effective reduction of the weight of the system claimed by Roschin and Godin is predicted if the magnetic body or the rotor can be regarded as a rigid part of the rotor and would be due to the force caused by the Earth's electric field. The rough quantitative estimates are mutually consistent with the observations in the system studied by Roschin and Godin.

For option II the dark matter at the magnetic body of the motor would be spontaneously magnetized and the conservation of energy and angular momentum would force the generation of large rotational energy and angular momentum in motor.

The dark matter at magnetic flux tubes means a new kind of phase of matter and the new kind of magnetic phase exhibiting long range entanglement of electrons [D8] (<http://www.extremetech.com/extreme/143782-mit-discovers-a-new-state-of-matter-a-new-kind-of-magnetism>) discovered quite recently in MIT might correspond to this phase. Even the possibility of high temperature super conductivity is speculated. This brings strongly in mind magnetic bodies and long



range entanglement made possible large value of  $h_{eff}$ . Could the magnets used by Yildiz represent this kind of systems?

One can say that the magnetic body of the rotor would serve as a kind of quantum battery [D9] (<http://www.extremetech.com/extreme/139857-quantum-entangled-batteries-could-be-the-perfect-power-so>) loaded from some large magnetic body by allowing cyclotron Bose-Einstein condensate analogous to population inverted laser consisting of electron Cooper pairs with anomalous large (due to large value of  $h_{eff}$ ) energy and angular momentum in same quantum state.

The dissipation of the magnetic motor requires energy feed and motor could apply Option I in each dissipative event to extract the compensating energy and angular momentum from its magnetic body, that is by sending negative energy dark photons absorbed by the magnetic body. This would gradually bring the Cooper pairs to low energy state and possible even induce their transformation to ordinary electron pairs. Compensating electron Cooper pairs would flow from the larger magnetic body thus filling the batteries.

The energy feed could also rely on a sequence of pairs formed by phase transition and its reversal (an analog for ...ATP ADP ATP ...). The phase transition analogs to ATP ADP would reduce  $h_{eff}$  and increase p-adic prime to keep the volume of flux quantum unchanged. The details of this mechanism were already discussed.

Magnetic motor would be a non-biological analog of plant. Solar radiation provides the metabolic energy of plant. Now the magnetic body of Earth or even Sun could provide the energy needed by the rotor. Basically also now Sun could be the ultimate energy provider.

The essential element of the concrete proposal is that the feed of energy and angular momentum is forced by the arrangement of the magnets: in standard model Universe there are severe objections against the proposal.

The following lists some of the challenges encountered if one wants to replicate the Yildiz magnetic motor.

1. How to create the circumstances in which the dark Bose-Einstein condensate from (say) magnetic body of Earth flows to the magnetic body the rotor. Reconnection of magnetic flux tubes is the basic mechanism and requires that local magnetic field strength and therefore also cyclotron frequency ( $\propto ZeB/m$ ), which depends on the mass  $m$  of the charged particles on the magnetic body is same. Could the proposed construction force the generation of reconnections to the magnetic flux quanta containing the desired dark Bose-Einstein condensates?
2. What is the role of the stator: is it absolutely necessary? The proposed concrete model requires stator. If the BE condensate flows through the magnetic body of the stator, does the inability of stator to rotate force it to flow to the magnetic body of rotor? Stator could have permanent connections to a larger magnetic body and the rotation of the rotor's magnetic body would continually generate reconnections with the magnetic body of stator and destroy them.
3. The magnets of Yildiz would not be ordinary magnets in TGD Universe: the flux sheets would have a large value of  $h_{eff}$ . How to generate the needed large value of  $h_{eff}$ ? Could the reconnection to dark flux quanta generate it automatically? In quantum critical systems one would expect large fluctuations of quantum coherence scales assignable with the fluctuations of the values of  $h_{eff}$ . What kind of quantum criticality in magnetic system could be considered. Could it relate to the process used to produce the magnets? Could the inventor have been able to control this process?

According to the TGD inspired model the magnetic flux quanta carry monopole fluxes and have no boundaries. The optimistic guess made already long time ago is that the magnetic field of any permanent magnet consists of monopole type flux quanta. This could be the case at least in the case of super-conductors where magnetic flux is quantized.

Could some kind of irradiation process generate the large value of Planck constant and be involved also with the reconnection process to dark magnetic flux sheets? Could this process take place spontaneously under some circumstances - say in the proposed situation in which torque remains constant and local magnetization directions of the small magnetized regions of the rotor and stator are stable against the effect of torque? The vision about prebiotic life forms defined by plasmoids consisting of circular dark water rings inspires also some guesses.

1. Water is not reported to be part of the system but it might be enough to have dark matter at magnetic bodies accompanying also plasmoids. The liberation of metabolic energy could be based on the general mechanism  $(h_{eff}, p) \rightarrow (h, p_1)$ ,  $p_1/p \simeq 2^k = h_{eff}/h$  liberating the difference of the energies of cyclotron states with different magnetic fields coherently for the entire system. This magnetic energy would be transformed to compensate dissipative losses for the rotational motion. The optimistic guess would be that dark solar light and dark electrons from some larger magnetic body could induce the transition of the magnetic body to large  $h_{eff}$  phase so that basically the analog of photosynthesis would be in question.
2. How the dark photons are obtained? One mechanism would be based on the modulation of high frequency radiation by low frequency radiation generating the dark photons. This mechanism might also transform solar photons to dark photons with large  $h_{eff}$ .
3. The attempt to understand Tesla's cold currents as dark supra currents led to the proposal that the dark phase is generated in electric fields with local strength above the field value inducing di-electric breakdown. This mechanism could be also involved with the over-unity energy production in the electrolysis of water. Also cell membrane involves electric field above the value giving rise to di-electric breakdown in air. Also the preparation of the magnetic motor of Yildiz could involve this kind of electric fields.

To sum up, there are clearly several open questions but the most optimistic option is that the proposed construction works as such.

## 4.8 Rotating systems and dark matter

The models for claimed anomalies associated with rotating systems were developed for more than decade ago. The developments in quantum TGD have led to a better understanding why just rotating systems could be special. The key idea is that phases with large value of Planck constant identifiable as dark matter are developed at the magnetic body of the system making the system macroscopic quantum system in some aspects. The recent picture allows also to make quantitative estimates about the value of Planck constant.

### 4.8.1 $h_{eff} = nh$ hierarchy from biological anomalies

Quantum biology inspires the hypothesis  $h_{eff} = n \times h$  of Planck constants labeling of levels of dark matter hierarchy [K54, ?]. The quantal effects of ELF em fields on vertebrate brain serve as a key motivation.

1.  $h_{eff}$  is assigned with Kähler magnetic flux tubes carrying dark matter as phases of ordinary matter, which are macroscopically quantum coherent for large values of  $h_{eff}$ .
2. The model of quantum biology leads to the hypothesis that EEG serving as communications tool between biological and magnetic body consists of dark photons which decay to ordinary photons in visible and UV range [K22]. This implies that the value of  $h_{eff}$  is rather large, or order  $10^{14}$ .
3. The model for the communications between magnetic body and biological body realized in terms of EEG and its possible generalizations leads to the hypothesis that the value of  $h_{eff}$  depends on ion being proportional to its mass number  $A$ , and thus has different value for each particle [K22]. This guarantees that the energy  $E = h_{eff} \times f$  associated with the cyclotron frequency  $E_c = ZeBh_{gr}/2\pi m$  is independent of the mass of the charged particle.

### 4.8.2 Nottale's findings and gravitational Planck constant $h_{gr}$

Nottale's [E29] finding that planetary orbits seem to correspond to Bohr orbits in gravitational potential with gigantic value of gravitational Planck constant. This inspires the hypothesis that quantum physics at gravitational magnetic flux tubes is characterized by the gravitational Planck constant  $h_{gr}$  [K67, K49].

1. By Equivalence Principle  $h_{gr}$  has the general form  $h_{gr} = GMm/v_0$ , where  $M$  and  $m$  are the interacting masses and  $v_0$  is a parameter with dimensions of velocity.  $v_0$  seems to correspond to a typical rotation velocity in the system formed by the masses. For three inner planets one has  $v_0/c \simeq 2^{-11}$ . Equivalence Principle allows to restrict the lighter system with mass  $m$  to be microscopic, say elementary particle or atomic systems in which case the orders of magnitude of  $h_{gr}$  and  $h_{eff}$  can be same and  $h_{gr} = h_{eff}$  can be considered [K55]. Note however that the gravitational Compton length is independent of  $m$ . Equivalence Principle favors formation of gravitational quantum coherence.
2. The notion of  $h_{gr}$  generalizes to that for other interactions. For instance, in electromagnetic case the formation of strong em fields implying charge separation leads to systems in which  $h_{em} = Z_1 Z_2 e^2 / v_0$  is large. Pollack's exclusion zone and its complement define this kind of systems and is identified as prebiotic life form.
3. Since the natural expansion parameter of perturbative expansion is the  $g^2/4\pi\hbar$ , one can say that transition to dark matter phase make the situation perturbative. Mother Nature is theoretician friendly.

### 4.8.3 Pollack's exclusion zones and fourth phase of water

$h_{em}$  might be large in the exclusions zones (EZ) appearing in the water bounded by gel. They were discovered by Pollack [L10], [K88], [L10].

1. EZ carries very large negative charge with positive charge outside the exclusion zone.
2. TGD interpretation is in terms of  $H_{1.5}O$  phase of water formed when every 4:th proton is transferred to magnetic body as dark particle with large value of  $h_{eff}$ . The proposal is that primitive life form is in question. Also entire hydrogen atoms could be transferred to the magnetic body but maximal electronic charge is obtained when all electrons remain in exclusion zone.
3. The pair formed by EZ and its complement could have large value of  $h_{eff} = h_{em} = Z^2 e^2 / v_0$ .
4. The velocity parameter  $v_0$  should correspond to some natural rotation velocity. What comes in mind is that complement refers to Earth and  $v_0$  is the rotation velocity at the surface of Earth. The prediction for  $h_{eff}$  would be of order  $h_{em}/h = 4\pi\alpha Z^2 \times .645 \times 10^6 \simeq 5.9 \times 10^4 Z^2$ .
5. Cell membrane involves also large charge separation due to very strong electric field over the cell membrane. Also now dark phases with large  $h_{em}$  or  $h_{gr}$  could be formed.

### 4.8.4 Does ATP synthase realize rotating magnetic system accompanied by dark matter with large $h_{em}$ ?

I have proposed that metabolic machinery generates large  $h_{eff}$  phase somehow [K55, K34].  $h_{eff} = h_{em}$  hypothesis allows to develop this hypothesis in more detail.

1. The rotating shaft of a molecular motor associated with ATP synthase is proposed to play a key role.
2. What comes in mind is that the rotational velocity  $v_0$  of the shaft appears in the formula for  $h_{em}$ . The electric field over the mitochondrial membrane generates charge separation and the product of charges of shaft and its complement should appear in the expression for  $h_{em}$ .
3. The value of  $v_0/c$  is expected to be of order  $10^{-14}$  from the angular rotation rate of ADP synthase about few hundred revolutions per second. The order of magnitude for  $h_{em}$  could be same as for  $h_{gr}$  associated with Earth-particle system.

### 4.8.5 Could rotating magnetic systems give rise to dark matter?

Rotating magnetic systems are claimed to exhibit anomalous such as spontaneous acceleration and over unity energy production [K4].

1. I have proposed that rotating magnetic systems give rise to dark matter at magnetic flux tubes associated with the system.
2. The parameter  $v_0$  appearing in the general formula for  $h_{eff}$  assigned with either em or gravitational flux tubes is identifiable as the rotation velocity of the system. One has order of magnitude  $v_0/c \sim 3 \times 10^{-8}$ .
3. Since these systems tend to be strongly charged, a natural guess is that  $h_{em}$  is in question. This makes possible quantitative estimate of  $h_{em}$  for say electron-system pair if the total charge of system can be estimated. This in turn allows to estimate the energy of ordinary photons produced in the transformation of dark photons to ordinary photons (bio-photons in living matter) making it possible to test the model.
4. One can ask why the rotation of the magnetic system is needed. Could the centrifugal acceleration drive dark particles to the magnetic body or keep them there thus stabilizing the dark phase? The dark protons at the magnetic body rotating with the system would remain to the magnetic body and would avoid transition to ordinary protons if it is induced by the vicinity of ordinary protons serving as seeds for phase transition. If this interpretation is in the right direction, the rotating magnetic systems might provide a manner to create dark matter. Also ATP synthase would have this function.

#### Acknowledgements

I am grateful for Alexander V. Frolov for providing me information about the work related to New Energy Technologies carried out in Russia, in particular the work of Roschin and Godin. I am grateful for email exchanges and discussions with Tapio Tammi, Jari Aaltonen, Juha Hartikka, and Jukka Kinnunen who have also generously provided material relating to the free energy research, in particular the findings about phase conjugation and various variants of Searl device. The discussions with Esa Maunu stimulated the ideas leading to the recent model of the Searl effect based on Faraday effect. The experimental work of Samuli Penttinen has quite recently led to an improved understanding of the role of concrete material composition of the Searl effect and his observation that nylon layers might serve as charge reservoirs has been very valuable.

## 4.9 Appendix

### 4.9.1 Miscellaneous considerations

#### Are the magnetostatic waves generated by the stator involved with remote metabolism?

The classical model for accelerating formation is based on the spontaneous acceleration occurring when Lorentz torque exceeds critical frictional torque. One can however consider also non-classical models as independent models or possible underlying microscopic mechanisms of the classical mechanism.

Since the air in the vicinity of the rotor is cooled the remote metabolism a based on generalized four-wave action with standing wave replaced by magneto-static wave rotating around the stator ring suggests itself as one possible mechanism making it possible to suck the rotational energy from environment. Magneto-static waves [D38] have been indeed assigned with over-unity effects. Magneto-static waves correspond to spin precession and involve the interaction with magnetic field and classical magnetic interaction whereas magnons are waves which involve purely quantum mechanical exchange interaction between neighboring spins.

If magnetic walls have large value of  $\hbar$  the cyclotron energy scale is much larger than the Larmor energy. This would require that the negative energy dark photons from magnetic walls decohere into a bundle of microwave photons in reversed time direction. In ordinary description this would

be interpreted as a self assembly of ordinary phase conjugate microwave photons to dark microwave photons with much higher energy.

### 1. Magnetostatic waves and remote metabolism

From the point of view of four-wave interaction magneto-static waves would serve as an analog of standing waves generating "reference beam" and its phase conjugate. According to [D38], magneto-static waves are generated surprisingly easily and the generation requires much less energy than the generation of ordinary electromagnetic waves: this might relate to the ability of these waves to "take care of itself" by sucking energy from the environment.

The existence of phase conjugate magnetostatic waves is an experimental fact and shown to lead to about  $10^4$ -fold amplification of the signal wave [D20]. The experiment involves a pumping microwave, the signal wave, and a phase conjugate wave, and the frequencies satisfy  $\omega_p = \omega_s + \omega_{pc}$ , where  $p$  refers to pumping microwave,  $s$  to magnetostatic wave representing signal, and  $pc$  to the phase conjugate magnetostatic wave. In the recent case a variant of this process in which magnetostatic wave itself acts as a pumping wave generating an amplified magnetostatic wave at a slightly higher frequency and a phase conjugate microwave at the Larmor frequency associated with  $B = .05$  Tesla. The discrete change of the Larmor frequency for stator could correspond to a change of the quantized magnetic flux by one unit: this makes sense if the transversal area of the flux quantum is about 200 nm. In the case of rollers spin flip transitions would generate microwaves at frequency of about  $f_L = .6$  GHz if the net magnetic field inside the roller is 0.5 Tesla and would correlate strongly with the formation of magnetic walls. Four wave mechanism suggests that a standing microwave is generated and magnetic walls are created at its nodes. In the case that only the spins of the electrons of  $J = 2$  Cooper pairs are flipped, the spin flip frequency equals to the Larmor frequency of electron.

Bifilar coils in which currents running in opposite directions produces nearly vanishing magnetic field, are known to have biological effects [I49] in particular, they are known to stimulate cell growth. A possible explanation is that the currents running in opposite directions induce magnetostatic wave inside the coil making possible remote metabolism by the generalized four-wave mechanism. Cells would suck energy from the bifilar in turn sucking energy from environment. One could say that bifilar coil would represent a lower level in the nutrition chain.

Searl has reported that the effect disappears, when the system is irradiated with radio waves of same wavelength as used in the fabrication of magnets, which must be of the order of the radius of the rotor. If the frequency of microwaves corresponds to magnetostatic frequency for electrons, their effect could be due the destruction of the coherence of the magnetostatic wave patterns so that they cannot suck the rotational kinetic energy from the environment.

### 2. Magnetostatic waves generated by stator

Magnetostatic waves do not actually propagate since in a good approximation the frequency does not depend on wave vector in the approximation that exchange interaction can be neglected: this is the case at the limit of long wave lengths. Hence complex time-periodic spatial patterns oscillatory mathematically completely analogous to plasma wave patterns are created. This of utmost importance since repeatedly recurring patterns are ideal for sustained representation of (conscious) information. Thus magnetostatic waves could be seen as magnetic analogs of plasmoids, which in TGD inspired theory of living matter are regarded as primitive life forms. Magnetostatic waves could be important also in living matter. The basic metabolic machinery is indeed analogous to electric power plant involving a rotating shaft and this machinery could be seen as a nano-scale Searl machine.

The allowed frequencies of magneto-static waves depend on boundary conditions (dispersion relations are derived by considering suitable continuity conditions at boundaries [D38]). The frequencies depend only on the external field  $H$  and on magnetization  $M$  besides geometric parameters. The dispersion relation for plane waves depends on the direction of the propagation relative to the direction of the magnetic field [D38]:

$$\omega = \sqrt{\omega_H(\omega_H + \omega_M \sin^2(\theta))} . \quad (4.9.1)$$

Here  $\theta$  is the angle between the magnetic field and direction of propagation. Using the units  $\mu_0 = \epsilon_0 = 1, c = 1, \omega_0$  resp.  $\omega_M$  are obtained from Larmor frequency by replacing  $B$  with the

magnetizing (external) field  $H$  resp. induced magnetization  $M$ . Hence one has  $\omega_0 + \omega_M = \omega_L$ . In the general case the frequency is in the range  $\omega_H \leq \omega \leq \sqrt{\omega_H(\omega_H + \omega_M)}$ .  $\omega_H = geH/2m$  is Larmor (spin flip) frequency of electron in the case that unpaired electrons are responsible for the magnetism.  $\omega_M = geM/2m$  is the Larmor frequency in the induced magnetization field. For Earth's magnetic field of nominal value  $.5 \times 10^{-4}$  Tesla one would have  $\omega_B \simeq .6$  MHz.

In the recent case  $M$  corresponds to the background magnetization of the stator magnet and  $H$  to the sum of rotating approximately dipolar magnetic fields generated by rollers inside the stator ring: can express  $H$  as  $\epsilon M_0$ , where  $\epsilon$  depends on the position around roller ring and  $M_0$  corresponds to the magnetization of roller (1 Tesla) in absence of  $H$ : note that  $H$  induces changes of  $M_0$  in ferromagnets. The geometry is cylindrical but since  $\theta = \pi/2$  holds true for the waves moving around the stator ring, a good guess is that  $\omega = \omega_L$  holds true. A band of frequencies results since  $H$  varies in some range determined by the distance of the roller rings. This deviation is also due to the fabrication. Unfortunately, it is not quite clear from the article of Godin and Roschin whether stator magnetization is parallel or antiparallel to the rotor magnetization. If they are parallel then the frequencies are below  $\omega_L = 12$  GHz. Otherwise above it.

The frequency of the magneto-static wave in stator would be determined by the magnetic field strength and due the variation in the direction and magnitude of the magnetic field would be in a band below or above 12 GHz. The rate for the change of the external magnetic field strength  $H$  created by the rotating rollers should be lower than that defined by Larmor frequency for this picture to make sense. This is obviously the case since electronic Larmor frequency is for a field strength of Tesla around 12 GHz whereas rotation frequency is around 10 Hz. This would correspond to wavelength of 3.5 cm. This is of the same order of magnitude as the width 5-6 cm of the observed magnetic walls so that there is a satisfactory consistency taking into account that the frequency of magneto-static waves varies.

The magnetic field generated by the stator inside rollers is time independent apart from the effect created by the magnetic inserts, and it is not clear whether magnetostatic waves are appreciably generated in this case.

### Could one understand the critical rotation frequency from the scaling law of homeopathy?

According to TGD inspired theory of consciousness, living systems possess besides the material body also a magnetic body having astrophysical size scale, and sensory representations are realized at the magnetic body using essentially remote mental interactions based on quantum entanglement and self-organization induces by microwaves [K39, K37]. The mechanism involves bound state entanglement having as a space-time correlate MEs at EEG frequencies. Of special importance are the frequencies in alpha band, in particular Schumann frequency of about 7.8 Hz associated with the lowest cavity resonance of Earth's magnetic field, are especially interesting. 10 Hz frequency is also fundamental one since it corresponds to the p-adic time scale  $T_2(127)$  defining the fundamental time scale in living matter: the average alpha frequency is 10 Hz. It also corresponds to the resonance frequency for the oscillations in ionospheric cavity with the property that the fields are almost constant in radial direction.

What makes the situation so interesting is that the critical rotation frequency has also an interpretation in terms of rotation frequency above which the torque produced by the ball bearing motor effect is larger than the torque of friction. Searl device might fail to function only because the friction torque has too large value!

In TGD inspired theory of living matter the basic mechanisms of homeostasis and remote mental interactions involve low frequency MEs (short hand for "massless extremals", topological light rays) serving as space-time correlates for bound quantum entanglement even in astrophysical length scales, and high frequency MEs propagating inside low frequency MEs like massless particles. High frequency MEs induce bridges between super-conducting magnetic flux tubes (or some other space-time sheets) and atomic space-time sheets (or some other space-time sheets), which in turn make possible the leakage of supra currents and their dissipation at the atomic space-time sheets giving rise to self organization.

The scaling law of homeopathy discussed in [K32] states that high frequency MEs and low frequency MEs accompany each other, and that their frequencies are in certain preferred ratios  $f_{low}/f_{high} = v/c$ , whose values can be understood in TGD framework. These ratios also correspond

to some characteristic velocities  $v$  of the system, say EEG wave phase velocities. Low frequency is cyclotron transition frequency  $f_c = ZeB/2\pi m$  of ion at a magnetic flux tubes of (say) Earth's magnetic field and high frequency corresponds to the zero point kinetic energy  $E_0(k) \simeq \pi^2/2mL_e(k)^2$  of ion liberated, when the ion drops from some space-time sheet to a much larger space-time sheet such as the magnetic flux tube of Earth. Both cyclotron energy and the zero point kinetic energy scale as  $1/L^2(k) \propto 2^{-k}$  as a function of p-adic length scale and are inversely proportional to the mass of ion so that the ratio  $f_{low}/f_{high}$  does not depend on the mass of the charged particle.

For the proton the zero point kinetic energy .5 eV for the atomic space-time sheet  $k = 137$  and corresponds to the basic energy quantum of metabolism in living matter.

1. For  $k = 137$  one has  $f_{high}/f_{low} = 2 \times 10^{11}$  for  $B = .5$  Gauss.
2. For  $k = 149$ , which corresponds to the p-adic length scale of 5 nm, one half of the cell membrane thickness, one has  $f_{high}/f_{low} = 10^8/2$  and the corresponding velocity is about  $v = 6$  m/s which is quite near to the velocity of alpha waves in brain. Note that the velocity depends on the local value of the Earth's magnetic field.
3. For  $k = 151$ , which corresponds to the p-adic length scale of 10 nm, the cell membrane thickness, one has  $f_{high}/f_{low} = 10^8/8$  and the corresponding velocity is about  $v = 24$  m/s.

The frequencies  $f_i$  of the low frequency MEs naturally correspond to the frequencies associated with the rotating magnetic system. The first frequency is the frequency  $f_{rot}$  of rotation for the ring of magnets and 10 Hz typically. The second frequency is the frequency of the oscillating magnetic and electric fields equal to  $f_{field} = N \times f_{rot}$ , where  $N$  is the number of rolling magnets,  $N = 23$  in the experiments considered so that one has  $f_{field} = 230$  Hz. Scaling law predicts that these frequencies give rise to microwave frequencies, which ought to manifest themselves in the field patterns associated with the system.

It is an interesting exercise to look whether the scaling law of homeopathy is consistent with various frequencies, scales, and velocities appearing in the system.

For the rotation velocity of 600 rpm, the rotation frequency of the ring system is about 10 Hz. The rotation velocity of the ring of magnets is 5.74 m/s at outer radius quite near to the 6 m/s of alpha waves and the velocity predicted by the scaling law for  $k = 149$  in Earth's magnetic field. From  $f_{high}(k = 149)/f_{low} = 10^8/2$  the wavelength of high frequency waves predicted by the scaling law is .6 m and defines the outer radius 57.4 cm of the ring magnet system in a good approximation. The value of  $f_{high}$  is .5 GHz and corresponds to microwave range.

The field pattern generated by the 23 rolling magnets oscillates with the frequency of  $23 \times 10 = 230$  Hz in this case. For  $f_{low} = 230$  Hz one has  $f_{high} = 23/2$  GHz which is rather near to the upper bound of 12 GHz for the magnetostatic resonance frequency and corresponds to the wavelength  $\lambda_{high} = 2.6$  cm, somewhat smaller than the diameter  $d = 3.7$  cm of the rolling magnets and the rough estimate 4 cm for the periodicity of the wavy magnetic field lines.

The problem with this estimate is that the local value of the Earth's magnetic field affects the estimate for  $f_{high}$ . One can however estimate  $f_{high}$  also directly from the zero point kinetic energy at  $k = 149$  space-time sheet by using .5 eV for proton at  $k = 137$  space-time sheet and scaling by  $2^{137-k}$ . For a protonic Cooper pair dropping from  $k = 149$  to  $k = 151$  space-time sheet one has  $\Delta E_0 = (1 - 1/4) \times 2^{137-149} \times .5$  eV and  $\lambda = 2.67$  cm, which is quite near to the estimate obtained using the scaling law.

### Other mechanisms of remote metabolism?

The fact that critical frequency is in 9-10 Hz range forces however to consider the possibility that topological light rays at these frequencies fundamental for the functioning of living matter are involved and spontaneous acceleration is accompanied by the emergence of a new source of energy. The energy quantum of metabolism in living matter is in the range .4-.5 eV and corresponds to the zero point kinetic energy when proton drops from atomic space-time sheet ( $k = 137$ ) to a larger space-time sheet. This energy corresponds also to the  $Z^0$  plasma frequency of water. Since 10 Hz frequency defines a fundamental bio rhythm, the question whether this ELF frequency might somehow induce the counterpart of biological metabolism so that the large value of energy quantum would make possible the spontaneous acceleration. Perhaps the generation of  $Z^0$  plasmoids,

which are nearly vacuum extremals coupling the classical  $Z^0$  fields and em fields and generating negative energy photons with energies about .5 eV and absorbed by protons dropping to larger space-time sheets, could provide the new source of energy. These negative energy photons could propagate through the wave guides provided by 10 Hz topological light rays. In this case the remote metabolism could occur in the length scale defined by the wave length of 10 Hz photon, roughly the circumference of Earth. This would make possible spontaneous acceleration.

As already found, the scaling law of homeopathy assigns the Larmor frequency of the magnetic system to the frequency 230 Hz. This would suggest that the new source of metabolic energy is realized as enhanced emission of the phase conjugate microwaves. According to the model for the scaling law of homeopathy the microwave MEs ("massless extremals" or topological light rays) would travel to the source of energy as particle like structures inside ELF MEs corresponding to 230 Hz frequency and serving as wave guides. The energy would be sucked from a considerably larger region since the wavelength of 230 Hz waves is 1300 km.

The scaling law of homeopathy in its original very restricted form ( $f_l/f_h = 2^{10^{11}}$ ) would assign to  $f_L = 207$  Hz the frequency  $f_h = .46 \times 10^{14}$  Hz whereas which the frequency associated with the .4 eV energy quantum of metabolism in living matter is about  $10^{14}$  Hz. Unfortunately, there is a discrepancy by a factor of  $\sim 1/2$ . One could of course consider the possibility that the dropping of electron Cooper pairs from the space-time sheet  $k = 149$  corresponding to the length scale of lipid layer of cell membrane (5 nm) provides the energy. In this case one cannot however assign  $Z^0$  plasma frequency with the process. An interesting question is whether the doubling of the rotation velocity (prevented by the loss of mechanical stability in the experiment of Russians) could excite the ordinary metabolism. In many-sheeted space-time particles topologically condense at all space-time sheets having projection to given region of space-time so that dropping makes sense only near the boundaries of space-time sheet of a given system. Also p-adic phase transition increasing the size of the space-time sheet could take place and the liberated energy would correspond to the reduction of zero point kinetic energy. Particles could be transferred from a portion of magnetic flux tube portion to another one with different value of magnetic field and possibly also of Planck constant  $h_{eff}$  so that cyclotron energy would be liberated.

## 4.9.2 Some general facts about classical solutions of field equations

### General considerations

The vanishing of Lorentz 4-force for the induced Kähler field means that the vacuum 4-currents are in a mechanical equilibrium. Lorentz 4-force vanishes for all known solutions of field equations which inspires the hypothesis that all extremals or at least the absolute minima of Kähler action satisfy the condition. The vanishing of the Lorentz 4-force in turn implies local conservation of the ordinary energy momentum tensor. The corresponding condition is implied by Einstein's equations in General Relativity. The hypothesis would mean that the solutions of field equations are what might be called generalized Beltrami fields. The condition implies that vacuum currents can be non-vanishing only provided the dimension  $D_{CP_2}$  of the  $CP_2$  projection of the space-time surface is less than four so that in the regions with  $D_{CP_2} = 4$ , Maxwell's vacuum equations are satisfied.

The hypothesis that Kähler current is proportional to a product of an arbitrary function  $\psi$  of  $CP_2$  coordinates and of the instanton current generalizes Beltrami condition and reduces to it when electric field vanishes. Kähler current has vanishing divergence for  $D_{CP_2} < 4$ , and Lorentz 4-force indeed vanishes. The remaining task would be the explicit construction of the imbeddings of these fields and the demonstration that field equations can be satisfied.

Under additional conditions magnetic field reduces to what is known as Beltrami field. Beltrami fields are known to be extremely complex but highly organized structures. The natural conjecture is that topologically quantized many-sheeted magnetic and  $Z^0$  magnetic Beltrami fields and their generalizations serve as templates for the helical molecules populating living matter, and explain both chirality selection, the complex linking and knotting of DNA and protein molecules, and even the extremely complex and self-organized dynamics of biological systems at the molecular level.

Field equations can be reduced to algebraic conditions stating that energy momentum tensor and second fundamental form have no common components (this occurs also for minimal surfaces in string models) and only the conditions stating that Kähler current vanishes, is light-like, or proportional to instanton current, remain and define the remaining field equations. The conditions



guaranteeing topologization to instanton current can be solved explicitly. Solutions can be found also in the more general case when Kähler current is not proportional to instanton current. On basis of these findings there are strong reasons to believe that classical TGD is exactly solvable.

### The dimension of $CP_2$ projection as classifier for the fundamental phases of matter

The dimension  $D_{CP_2}$  of  $CP_2$  projection of the space-time sheet encountered already in p-adic mass calculations classifies the fundamental phases of matter. For  $D_{CP_2} = 4$  empty space Maxwell equations hold true. This phase is chaotic and analogous to de-magnetized phase.  $D_{CP_2} = 2$  phase is analogous to ferromagnetic phase: highly ordered and relatively simple.  $D_{CP_2} = 3$  is the analog of spin glass and liquid crystal phases, extremely complex but highly organized by the properties of the generalized Beltrami fields. This phase is the boundary between chaos and order and corresponds to life emerging in the interaction of magnetic bodies with bio-matter. It is possible only in a finite temperature interval (note however the p-adic hierarchy of critical temperatures) and characterized by chirality just like life.

### Could the strange effects in rotating magnetic systems relate to $D_{CP_2} = 2 \rightarrow 3$ phase transition?

The general picture could have non-trivial implications also in the case of rotating magnetic systems.

1. A non-vanishing vacuum Kähler charge density is generated when a constant magnetic field is put into rotation. The non-vanishing charge density is not consistent with the vanishing of the Kähler 4-current and requires a 3-dimensional  $CP_2$  projection and topologization of the Kähler current. Beltrami condition cannot hold true exactly for the rotating system. The conclusion is that rotation induces a phase transition  $D_{CP_2} = 2 \rightarrow 3$ .
2. This could help to understand various strange effects related to the rotating magnetic systems. For instance, the increase of the dimension of  $CP_2$  projection could generate join along boundaries contacts and wormhole contacts leading to the transfer of charge between different space-time sheets. The possibly resulting flow of gravitational flux to larger space-time sheets might help to explain the claimed antigravity effects.
3. The phase transition implies a qualitative change in the structure of the magnetic fields and could thus explain the generation of magnetic walls observed in the rotating magnetic system. What is fascinating that  $D_{CP_2} = 3$  phase corresponds to the living matter in the proposed classification. This would conform with the idea that the ADP-ATP machinery responsible for the metabolism is a molecular Searl machine. Hence the strange effects observed in rotating magnetic systems might reveal the fundamentals of the dead  $\rightarrow$  alive phase transition.

### 4.9.3 Could spontaneous acceleration be due to the change of inertial mass?

The first model for the reduction of inertial mass was based on the reduction of inertial mass inducing pirouette effect. This mechanism could explain the spontaneous acceleration if one accepts the new view about the relationship between gravitational and inertial energy (the earlier model was based on strict form of Equivalence Principle). The reduction of the inertial mass alone cannot explain the strong parity breaking effects, and the observed fast increase of the weight change with the rotation velocity and classical  $Z^0$  and em forces are needed. Applying Occam's razor one could conclude that classical em and  $Z^0$  forces are all that is needed and the possible gravitational and inertial effects are quite too weak to explain the effects. It is however possible that the generation of gravitational and inertial energy from vacuum occurs in much smaller quantities and the resulting model could serve as a general model for these effects in different contexts.

#### The reduction of inertial mass and pirouette effect

If the angular momentum of the rotor can be assumed to be conserved, one can understand the rapid angular acceleration as a pirouette effect caused by the reduced inertial mass causing the

reduction of moment of inertia. For the clockwise rotation direction the net change of the weight is about 1 per cent in the range 550 – 600 rpm and starts from mass reduction of 30 per cent, which would mean 3.5 kg change of inertial mass, which would be a rather dramatic effect.

This crazy sounding prediction might be killed by simple experimental tests (note however that inertial mass could be invisible in the case that it resides at non-standard space-time sheets). One cannot deny that the hypothesis about the reduction of the inertial mass is on somewhat shaky grounds since it relies basically on the pirouette mechanism and has so dramatic implications. The simplest assumption is that similar process occurs also for the counter clockwise rotation.

The conservation of angular momentum gives

$$L = I\omega = \text{constant} . \quad (4.9.2)$$

Here  $I$  denotes the moment of inertia.  $I$  is proportional to mass and thus decreases. Denoting by  $m = xm_0$  the reduced mass one has  $I = xI_0$ . Therefore the rotation frequency  $f$  must be inversely proportional to the mass:

$$\frac{f}{f_0} = \frac{m_0}{m} . \quad (4.9.3)$$

where  $m$  refers to inertial mass. Now the moment of inertia decreases because the mass is reduced: usually the system gets thinner in the direction defined by the axis of rotation.

In the absence of other effects the predicted dependence of  $\Delta m/m_0$  on  $f$  above critical rotation frequency  $f_{cr}(\pm)$  in the region of rapid acceleration would be

$$\frac{|\Delta m|}{m_0} = 1 - \frac{f_{cr}(\pm)}{f} . \quad (4.9.4)$$

Below  $f_{cr}$  there would be no effect. The reduction of effective weight however begins already at  $f_0 \sim 200$  rpm so that other effects must be involved. Classical  $Z^0$  force is the most natural candidate responsible for these effects.

#### **A parameterization for the changes of inertial mass and redistribution of gravitational flux**

Assume that there is change of inertial mass and redistribution of gravitational flux above the critical frequency. The dependence of the inertial mass on frequency can be parameterized in the linear approximation as

$$m(f) = m_0 \frac{f_{cr}(\pm)}{f} \text{ for } f \geq f_{cr}(\pm) . \quad (4.9.5)$$

The general formula 4.3.10 gives for the fractional change of the effective weight

$$\begin{aligned} \frac{\Delta[m_{eff}(f, \pm)]}{m_0} &= \theta(f - f_{cr}(\pm)) \left[ \epsilon(f) \frac{f_{cr}(\pm)}{f} - 1 \right] \\ &\mp \frac{Q_Z(f, \pm)g_Z E_Z + Q_{em}(f, \pm)eE_{em}}{m_0 g} \end{aligned} \quad (4.9.6)$$

in the proposed parameterization.

1. The possibly occurring reduction of the inertial mass occurs freely at least during the step, which corresponds to  $\Delta G/G \simeq .01$  per  $\Delta f = 50$  rpm giving slope  $d(\Delta G/G)/df \sim .1/f_{cr}$ . For  $\epsilon(f) = 1$  the slope would be  $1/f_{cr}$  and 10 times larger so that also the redistribution of gravitational flux should also be present and its change must together with the inertial mass must almost compensate for the growth of weight caused by the increase of  $Z^0$  charge. This would require that  $d\epsilon/df \sim 1.3$  at  $f = f_{cr}$ . This would mean that the fraction of the gravitational flux feeded to the space-time sheet carrying the Earth's gravitational field must increase.

2. The gravitational mass of the system must increase at least by the same amount as the inertial mass is reduced in the process. Since positive and negative inertial energy matter can be generated, the change of gravitational mass can be larger than the change of the inertial mass. If the resulting new gravitational flux is feeded to the space-time sheet carrying the gravitational field of Earth the standard distribution of gravitational flux changes in the desired manner. One expects that the distribution of the gravitational flux returns to the normal later.

Remark: In [H47] it is stated that in the area 550 rpm a force against the direction of the gravitational vector is created. Figure 1 however implies just the opposite of this interpretation since the reduction of the weight slows down. Also the statement that the weight of the device quickly changes at 550 rpm is in conflict with figure 1.

3. The simplest parameterization for the redistribution of the gravitational flux for clockwise rotation is

$$\epsilon(f) = 1 + k \times \frac{f - f_{cr}(+)}{f_{cr}(+)} , \quad k \simeq 1.3 . \quad (4.9.7)$$

in the range  $\Delta G/G \in [30 - 31]$  per cent. Of course, the effects should be present also above this range if the reduction of inertial mass is the explanation of the spontaneous acceleration. The process might be regarded as a phase transition and the conjecture of the authors of [H47] is that this is the case and that similar phase transitions could occur also at higher rotation velocities.

The phase transition would create a vacuum extremal having a gravitational mass and would be followed by a continuous flow of positive inertial mass from the magnetic system. The slow down of the rapid spontaneous acceleration would be due to the coupling of the load so that angular momentum conservation would not hold true anymore. Thus the reduction of the inertial mass would not be anymore visible as an acceleration.

A similar parameterization works also in the counter clockwise situation and the simplest assumption is the same phase transition occurs and the parameterization is identical. The reduction of inertial mass causes acceleration but the growth of gravitational mass compensates this effect to the weight and only steepens increase the rate of mass change due to the  $Z^0$  force. Indeed, in [H47] it is stated that in area 600 rpm a force in the direction of the gravitational force of Earth is created.

### Could the generation of self-organizing vacuum extremals induce a reduction of inertial mass and increase of the gravitational mass?

Vacuum extremals correspond to regions of space-time where induce Kähler field vanish, are vacua with respect to the density of inertial energy. In vacuum regions em and  $Z^0$  fields are non-vanishing in general and  $Z^0/\gamma$  ratio satisfies  $Z^0/\gamma = 4/\sin^2(\theta_W) \simeq 8$ . Thus there is a coupling between classical  $Z^0$  em fields which might be of importance. The presence of classical  $Z^0$  magnetic and electric fields inducing strong parity breaking effects would conform with the observed dependence of the effect on the direction of rotation serving as a direct signature of parity breaking effect.

Vacuum regions are not gravitational vacua and the generation of these kind of regions could give rise to a creation of matter and antimatter whose inertial energies would have opposite sign and cancel each other. Einstein's equations tell the density of gravitational four momentum generated in the process and if highly curved space-time sheets are created, creation of considerable amounts matter is unavoidable. This kind of regions could contain quite considerable density of positive and negative energy matter, say as photons and their phase conjugates and perhaps even positive energy electrons and negative energy positrons.

Vacuum regions are non-deterministic and un-stable against phase transitions changing the topology of the space-time sheet as well as generation of inertial energy. The inherent instability of vacuum means that they would gradually self-organize to non-vacua by emitting negative energy matter, in particular phase conjugate photons, and thus develop a net positive inertial energy.

The behavior of these systems would have a definite evolutionary aspect, which suggests that the creation of vacuum regions is the quintessence of life. System is living as long as it can create these regions and utilize the energy sucked by these regions as they self-organize to positive energy states by sending negative energy into the environment. Plasmoids are excellent candidates for regions evolving from inertial vacuum. Plasmoids indeed seem to be primitive life forms.

The changes the gravitational and inertial masses of the system would be a signature of this process. Gravitational/inertial anomalies have been repeatedly reported to accompany over unity effects. The vacuum extremal is unstable and stabilizes by generating negative net inertial mass. This is achieved by a flow of a fraction of positive energy matter out of the system. A plausible looking idea is that gravitational energy might be created from vacuum in the energy scale which corresponds to the magnetic energy density associated with the magnetic walls: this would make roughly  $10^{-4}$  eV per atomic volume which corresponds to the frequency of 10 GHz microwaves associated with magneto-static waves. In this case the effects on inertial and gravitational masses are of course completely negligible and visible only as remote metabolism.

The assumption that the changes of inertial mass and redistribution of gravitational mass are responsible for the effective weight change requires that matter is created from vacuum in macroscopic amounts. If 1 kg of both positive energy electrons and negative energy positrons are created in a volume of 1 cubic meter, roughly 1 electron per atomic volume would be created and it seems that Coulomb repulsion does not allow so dense a plasma. Needless to say, the laboratory scale big bang creating kilograms of matter from vacuum would mean a technological revolution. Of course, so high a density of matter created from vacuum looks highly implausible. The hypothesis can be killed by comparing this density to the density of plasma phase just outside the system. Of course, positive energy matter could also flow also to larger space-time sheets and remain invisible.



## Chapter 5

# Did Tesla Discover the Mechanism Changing the Arrow of Time?

### 5.1 Introduction

After having made the inventions providing much of the basis technology for the modern electricity based society, Tesla used the rest of his life to study the strange phenomena related to sharp electric pulses. Tesla became convinced that pulse like rays carrying longitudinal electric fields exists although Maxwell's theory does not allow them. Needless to say, Tesla's findings were not taken seriously by the scientific establishment. On the other hand, for the developers of so called free energy technologies Tesla has remained a magic figure. To me it has gradually become clear that it might be possible to formulate the visions of Tesla using the language of modern physics.

The final breakthrough came with a discovery of a mechanism generating what I have used to call negative energy topological light rays having phase conjugate laser waves as physical counterparts. Negative energy topological light rays provide the fundamental control mechanism in the TGD based model of living matter and appear in practically every mechanism of consciousness as a basic step. This is however not yet the whole story. One should also identify mechanisms allowing to control the generation of the negative energy topological light rays: direct transformation of p-adic MEs to negative energy MEs is probably not enough. The solution to the problem came from a quite unexpected direction. It was the attempt to understand the physics behind the visions of Tesla which led to an identification of a very general mechanism of this kind.

Phase conjugate laser waves break second law of thermodynamics and this is possible in TGD Universe below the p-adic time scale characterizing the system. Therefore short pulses are ideal for this purpose. Depending on the situation, electric pulses in electric circuits typically force the charge carriers to accelerate or decelerate. During deceleration positive energy photons are emitted as brehmstrahlung whereas during acceleration charges emit negative energy photons in order to receive energy. Thus generation of pulses provides a mechanism to generate negative energy topological rays which in turn serve for various control purposes. TGD indeed predicts the existence of scalar wave pulses propagating in vacuum with light velocity and carrying longitudinal electric fields.

One can understand the basic findings of Tesla at qualitative level in TGD framework and there are strong reasons to believe that Tesla was right after all. This of course raises the question how it is possible that the scientific community with all its technology remained silent about the findings of Tesla for an entire century. Experimentalists must have made occasional encounters with the phenomena reported by Tesla. Are modern experimentalists conditioned to take theorists quite too seriously?

In this chapter the general vision allowing to understand the findings of Tesla and others relating to binary coils and Tesla transformers are discussed. The solutions describing Tesla's scalar wave pulses are discussed. The new physics associated with binary coils is discussed in detail and a detailed model for binary coil and transformer using binary coil as a primary is constructed using the experimental input provided generously by Tapio Tammi. The findings of Tesla are discussed at general level using the resulting over all picture. The chapter ends with the model for the causal

anomalies observed in the tunnelling of photons through potential barriers.

The appendix of the book gives a summary about basic concepts of TGD with illustrations. There are concept maps about topics related to the contents of the chapter prepared using CMAP realized as html files. Links to all CMAP files can be found at <http://www.tgdtheory.fi/cmaphtml.html> [L8]. Pdf representation of same files serving as a kind of glossary can be found at <http://www.tgdtheory.fi/tgdglossary.pdf> [L9]. The topics relevant to this chapter are given by the following list.

- Zero Energy Ontology (ZEO) [L31]
- Classical TGD [L15]
- Topological field quantization [L27]

## 5.2 Discussion of the basic ideas and concepts

### 5.2.1 Do negative energy space-time sheets have counterparts in quantum field theory?

Negative energy topological light rays seem to correspond to phase conjugate laser waves. In particular, the experiments of Feinberg [D5] are consistent with the transparency of matter for phase conjugate laser beams with photon energies above thermal energy. In optics phase conjugation requires optically non-linear system [D35]. For instance, in usual hologram the matter is optically non-linear in the sense that dielectric constant depends on the external electric field so that the electromagnetic radiation induces a change of the refraction coefficient which in turn codes for the hologram.

The dynamics of classical fields is indeed extremely nonlinear in TGD: the topological field quantization is one of the most dramatic outcomes of this non-linearity. Whether the phenomenological models for phase conjugate waves and for their generation are enough in TGD framework is an open question. The mechanism based for the generation of negative energy topological light rays based on short pulses to be discussed in this section does not seem to reduce to the framework of non-nonlinear optics.

There are also questions of principle involved.

#### Is phase conjugation properly understood in quantum field theories?

At the level of quantum physics negative energy photons would correspond to a system quantized in such a manner that both bosonic and fermionic annihilation and creation operators have changed their roles. Negative energy photons and fermions do not correspond to (non-existing) "anti-photons" and anti-fermions. Using the terminology of Dirac's bra-ket formalism: negative energy systems are like bras if positive energy photons are kets. Kets and bras correspond to Hilbert space and linear functionals defined in it. The space of bras is actually not equivalent with that of kets but in a well defined sense a more general concept. This conforms with the role of negative energy space-time sheets in TGD inspired theory of consciousness.

In quantum field theories time reversal transforms creation operators for fermions to creation operators for anti-fermions. Vacuum state is not changed. Time reversal in TGD sense would transform ket vacuum to bra vacuum so that the earlier creation operators annihilate the new vacuum state and genuine negative energy states result. This would suggest that negative energy states are something genuinely new and a genuine outcome of the many-sheeted space-time concept allowing either bra and ket type vacuum at a given space-time sheet. It has turned out that zero energy ontology (ZEO) allows to formulate this intuition rigorously.

#### Phase conjugation and irreversibility

One interesting aspect associated with negative energy topological light rays is that they seem to be irreversible systems. On the other hand, phase conjugation can be used to eliminate perturbations on signal caused by thermal noise since the evolution proceeds from perturbed to non-perturbed

signal. This could be seen as an objection against TGD based interpretation stating that topological light rays are essentially non-dissipative structures of classical physics.

The objection can be circumvented. Classical-quantum correspondence implies that space-time physics mimics also the dissipative aspects of quantum dynamics defined by quantum jump sequences. The classical non-determinism of the basic variational principle makes this possible. Classical fields are non-dissipative structures are even able to represent information about dissipation, analogous to a written text telling a story about growth, flourishing, and decay. In fact, in TGD framework space-time itself provides symbolic classical representations for quantum jump sequences determining the subjective, experienced reality. The implications of this representative aspect for biology are highly non-trivial. For instance, phase conjugate waves could provide a fundamental mechanism of healing and error correction.

### **Matter-antimatter asymmetry, phase conjugation for fermions, and new energy technology**

If photons with negative energies are allowed, it is difficult to deny the possibility of fermions with negative energies. The possibility of having both signs of energy suggests an elegant solution to the problem of matter-antimatter asymmetry and a powerful new energy technology.

1. The standard second quantization of Dirac spinors postulates that ground state is annihilated by annihilation operators for fermions and anti-fermions. One can construct explicitly the state annihilated by annihilation operators. Suppose that there is state which is not annihilated by any annihilation operator and apply the product of all annihilation operators to this state. Electrons and positrons represent holes in this sea and are created by applying creation operators. The states have positive energy with respect to the ground state. The aesthetic problem of this quantization is that ground state has an infinitely high negative energy.
2. In TGD framework one could change the role of creation and annihilation operators so that the ground state would be obtained by applying the product of all creation operators to vacuum. This state would have infinite positive energy. Fermions and anti-fermions would be holes in Dirac sea of positive energy and behave as negative energy quanta. One might expect that these two quantizations correspond to two different time orientations for the space-time surface.

#### *1. Two manners to circumvent the infinite vacuum energy*

The infinite vacuum energy is definitely something very unsatisfactory, and one should overcome this problem somehow. The most elegant and predictive variant of TGD inspired cosmology assumes that the net energy of the Universe vanishes so that the universe could have been created intentionally from vacuum (and be created again and again in each quantum jump). The vanishing of the total energy follows automatically if one poses the condition that the energy flow through the light cone boundary ( $H = M_{\pm}^4 \times CP_2$ ) vanishes. This requires that also fermionic vacuum energies cancel each other. There are two manners to achieve the cancellation.

1. If positive and negative energy space-time sheets are always created in a pairwise manner their vacuum energies could compensate each other, at least so if some additional conditions are satisfied. The success of elementary particle physics requires that this mechanism is at work in elementary particle length scales.
2. Vacuum energies could also cancel each other for each space-time sheet separately. This is achieved if the roles of creation and annihilation operators for either fermions or anti-fermions are exchanged. This implies automatically matter antimatter asymmetry since either fermions or anti-fermions would have negative energies. This option could be realized in long length scales and explain the absence of antimatter from the Universe as absence of positive energy antimatter. It would thus seem that all four ground states states are in principle possible and that the ground state characterizes the phase of matter.



2. *Zero energy vacuum is matter-antimatter asymmetric*

Consider now in more detail the latter option 2) assuming for definiteness that it is anti-fermions for which the roles of creation and annihilation operators are exchanged. The ground state is obtained by applying the product of all fermion annihilation operators and anti-fermion creation operators to vacuum. Fermions represent holes in a completely filled negative energy Dirac sea and have positive energy. Anti-fermions represent holes in positive energy Dirac sea and have thus negative energy. In this ground state annihilation of photon pair is possible only to an fermion with positive and anti-fermion with negative energy.

Obviously the state is matter-antimatter asymmetric since anti-fermions cannot appear as positive energy holes. Negative energy antimatter could be present but could have remained invisible. For instance, Pauli Exclusion Principle would make the scattering of negative energy anti-fermions impossible in the case that there are not sufficiently many holes in the sea. The same occurs for condensed matter electrons below the surface of the Fermi sphere. Even in the case that negative energy anti-fermions are present abundantly, they might have escaped detection. Due to the prevailing dogmas, no-one has tried to detect signatures for the scattering of negative energy anti-fermions or two photon annihilation to a pair of positive energy fermion and negative energy anti-fermion.

3. *Creation of matter from vacuum by annihilation of laser waves and their phase conjugates?*

The possibility of negative energy anti-fermions suggests a new energy technology. Photons and their phase conjugates with opposite energies could only annihilate to a pair of positive energy fermion and negative energy anti-fermion. Vacuum could effectively serve as an unlimited source of positive energy and make creation of matter from nothing literally possible. The idea could be tested by allowing laser beams and their phase conjugates to interact and by looking whether fermions pop out via two-photon annihilation. Fermion-anti-fermion pairs with arbitrarily large fermion masses could be generated by utilizing photons of arbitrarily low energy. The energies of the final state fermion is completely fixed from conservation laws so that it should be relatively easy to check whether the process really occurs. Generalized Feynman rules predict the cross section for the process and it should behave as  $\sigma \propto \alpha^2/m^2$ , where  $m$  is the mass of the fermion so that annihilation to electrons is the best candidate for study. Bio-systems might have already invented intentional generation of matter in this manner. Certainly the possible new energy technology should be applied with some caution in order to not to build a new quasar!

### 5.2.2 Is the TGD view about phase conjugate waves consistent with the existent wisdom?

A priori it is not obvious that the TGD based identification of phase conjugate waves as negative energy photons/topological light rays is consistent with what is known about phase conjugate waves. The best manner to check this is to translate the standard physics description of the basic mechanisms producing phase conjugate waves to the language of TGD. This should also provide new insights about how self-organization by the emission of negative energy photons proceeds in non-linear media.

#### Basic mechanism producing phase conjugate waves

There are two basic mechanisms producing phase conjugate waves. The physics believed to be behind these mechanisms is summarized in an enjoyable manner in the book of D. M. Pepper [D35], and in the review article of V. V. Shunov and B. Ya. Zeldovich [D37], who are pioneers of optical phase conjugation. The mechanisms rely on four-wave mixing and stimulated Brillouin scattering. Both mechanisms can be modeled using the notion of a dynamical hologram. In TGD framework dynamical hologram can be regarded as a spontaneously generated self-organizing hologram resulting by the emission of negative energy photons. The reference laser beam is quite generally pulsed. This raises the question whether the phase conjugate photons are produced by negative energy scalar wave pulses inducing negative energy "acceleration radiation" as the (em- or  $Z^0$ -) charged particles are accelerated at the space-time sheets representing scalar wave pulses.

### 1. Four-wave mixing

Consider first four-wave mixing. The basic observation is that already in the case of ordinary hologram a phase conjugate beam is generated when the reference beam irradiating the hologram has a direction opposite to that of the original reference beam. The idea is to replace the static hologram with a dynamic hologram by utilizing reference beams moving in opposite directions simultaneously besides the probe beam coming from the object, so that the beams used to construct and read the hologram are simultaneously present. Either reference beam can be thought of as being scattered from the interference pattern created by the other beams and producing the phase conjugate wave. The resulting phase conjugate wave moves in a direction opposite to the probe beam, just as in the case of the ordinary hologram. The dynamic hologram is created in the non-linear medium whose properties are affected by the interference pattern formed by the beams.

TGD description would be that the interference of the three beams induces self-organization of the non-linear medium to a higher energy state representing the dynamic hologram and that this occurs by the emission of the phase conjugate wave having negative energy. This means the breaking of the second law of thermodynamics. The phase conjugate waves are dissipative structures but the dissipation takes place in a reversed direction of geometric time. To be precise, classical fields can be seen as symbolic representations for the dissipation at quantum level and possible by the non-determinism of Kähler action. This explains the strange features of phase conjugate waves.

### 2. Stimulated Brillouin scattering

Stimulated Brillouin scattering was first discovered to produce phase conjugate waves [D37] by Boris Ya. Zeldovich and his colleagues, the Russian pioneers of optical phase conjugation. Only single incoming reference beam is used and the secondary reference beam in the opposite direction appears spontaneously. In this case three-wave scattering without probe beam is in question and interference pattern is solely due to the interference of the reference beams. The dynamical hologram is realized as an acoustic wave pattern from which either reference beam can be said to scatter. The phase conjugate wave is generated only above a critical power feed for the incoming beam. The incoming beam can be distorted in the directions transversal to the primary beam by allowing it to traverse an inhomogeneous glass plate. The resulting phase conjugate beam traverses back through the inhomogeneous glass plate and turns out to be free of any distortions. Obviously this demonstrates the occurrence of the time reversal.

The standard description for what happens runs as follows.

1. The process is initiated by the scattering of photons from thermal phonons in the direction of the primary reference beam and reversing thus their direction. By energy conservation the frequency difference for the two light beams corresponds to the frequency of the acoustic wave:  $\Delta\omega/\omega = v/c$ , where  $v$  is the sound velocity.
2. Acoustic wave generates a periodic longitudinal density gradient such that the zones of low and high density are at a distance of *half* wave length: this follows from the fact that the scattered phonons receive *twice* the momentum of photon. In this kind of situation total reflection occurs from each layer and this amplifies the secondary light beam which in turn amplifies the sound wave. A more familiar example of total reflection is the reflection of light on water having oil layer at its surface. The varying thickness of this layer gives rise to a rainbow like appearance of the scattered light. Also a phase conjugate beam is created in the process.

In TGD framework situation can be seen as a self-organization process in which the self-organizing acoustic wave gains energy by emitting negative energy photons: obviously an over unity energy production breaking the second law of thermodynamics is in question. One could even say that non-linear medium builds a primitive sensory representation of the interference pattern.

1. At the first step the photons of the primary reference beam are scattered and generate a weak secondary reference beam in an opposite direction. The resulting interference pattern in turn excites a weak acoustic wave.

2. The acoustic wave amplifies itself when phonons emit pairs of positive and negative energy photons with energies  $E_1 > 0$  and  $E_2 < 0$  such that the sum of their energies corresponds to the energy  $E_{ph}$  gained by the phonon:  $E_1 - |E_2| = E_{ph}$ . The rate of this process is proportional to the numbers  $N_+$  and  $N_-$  of positive and negative energy photons already present in the state: the mechanism of induced emission is at work. Positive energy photons amplify the induced reference beam and negative energy photons amplify the phase conjugate wave. Also in this case one can say that the non-linear medium builds up spontaneously a dynamical hologram about the interference pattern.

### Over unity effects and error correction

The emission of negative energy photons makes possible over unity effects claimed by free energy enthusiasts. Over unity effects need not be in conflict with the standard wisdom that phase conjugate waves utilize the energy of pumping laser or probe beam. In the case of stimulated Brillouin scattering the negative energy photons are received by the population inverted lasers producing the reference beam with the consequence that particles drop to the ground state without emission of positive energy photons. In the case of 4-wave mixing the negative energy photons could be received by the laser producing the probe beam. An interesting possibility is that negative energy beams could be produced also in the direction of reference beam and pump energy from the corresponding lasers.

Error correction of a signal defines a variant of the time mirror mechanism (see fig. <http://www.tgdtheory.fi/appfigures/timemirror.jpg> or fig. 24 in the appendix of this book). In this case positive and negative energy signals are actually at different sides of the time mirror. The positive energy photons of the signal to be corrected annihilate with the negative energy photons of the phase conjugate signal which comes from the geometric future and is a temporal mirror image of the positive energy signal. The pulsed phase conjugate mirror would be an analog a sequence of ordinary mirrors. Pulses create a temporal sequence of time mirrors most naturally located at the ends of pulses so that positive energy photons from  $N$ :th pulse annihilate with negative energy photons from  $N + 1$ :th pulse.

### TGD based description for the interference of reference beams

It is interesting to find whether TGD allows the field pattern resulting as a superposition of reference beams moving in opposite direction as a solution of field equations. Topological light rays do not allow this kind of field patterns. As a special case this field pattern corresponds to a transversal standing wave of form  $\cos(\omega t) \times \cos(\omega z)$  (using units  $c = 1$ ). Waves for which the interference pattern moves (say in the case of stimulated Brillouin scattering), result when the frequencies are different. These field patterns are obtained as Lorentz transforms of the standing wave pattern.

Since the Kähler current vanishes for this kind of waves the field equations state that the contraction of the energy momentum tensor with the second fundamental form vanishes. It will be found that the field equations reduce to massless wave equation in the approximation that classical gravitational effects are negligible. It is however not clear whether this kind of solution is possible as genuinely asymptotic self-organization pattern having a precisely vanishing Kähler current.

The solution ansatz is based on the assumption that the  $CP_2$  projection belongs to the homologically non-trivial geodesic sphere  $S^2$  of  $CP_2$ . Let the standard spherical coordinates of  $S^2$  be  $(U \equiv \cos(\theta), \Phi)$ . Let  $M^4$  coordinates be  $(t, z, x, y)$ . The task is to imbed the electric field representing a standing wave and having components

$$E_i = \epsilon_i \times \cos(\omega t) \times \cos(\omega z) , \quad (5.2.1)$$

as a four-surface to  $X^4 \subset M_+^4 \times S^2$ . The polarization vector  $\epsilon_i$  lies in the  $(x, y)$ -plane.

The 4-vector potential associated with this field is

$$A_\mu = \frac{\epsilon_\mu}{\omega} \times \sin(\omega t) \times \cos(\omega z) . \quad (5.2.2)$$

Note that the scalar potential  $\phi = A_t$  vanishes. The induced Kähler gauge potential is of form

$$A_\mu = U \partial_\mu \Phi , \quad (5.2.3)$$

and from this the simplest ansatz (fixed only apart from a canonical transformation of  $CP_2$ ) reproducing  $A_\mu$  is

$$U = a \times \sin(\omega t) \times \cos(\omega z) , \quad \Phi = b \times \epsilon_\mu x^\mu , \quad ab = \frac{1}{\omega} . \quad (5.2.4)$$

In the approximation that the induced metric is flat, action density vanishes, and the energy momentum tensor has only the longitudinal components  $T^{tt}$  and  $T^{zz}$  and is proportional to the flat metric. Field equations reduce to massless wave equation in longitudinal degrees of freedom:  $D^2 u = 0$  and  $D^2 \Phi = 0$ ,  $D = \partial_t^2 - \partial_z^2$ . For the proposed solution ansatz they are satisfied identically.

The fact that solution has a 2-dimensional  $CP_2$  projection means that it represents a self-organization pattern with dissipation only due to the possible non-vanishing of the Kähler 4-current and characterized by the strength of classical gravitational interaction. Classical gravitation might imply a non-vanishing Kähler four-current.

### 5.2.3 Pulses, Tesla transformers, and binary coils

The function of quite a many free energy systems involve sharp pulse sequences. Often the bi-filar coil invented by Tesla [H53] are used. Also Caduceus coil having also binary structure is utilized. Together with general TGD based vision this leads to a theoretical picture allowing to understand the visions of Tesla theoretically.

#### The vision briefly

A very concise summary of the model goes as follows.

1. The basic prediction of TGD are negative energy topological light rays propagating backwards in geometric time. They can be accompanied by self-generated negative energy photons since in general case topological light rays carry light like vacuum 4-current. The interpretation as counterparts of phase conjugate laser waves [D35] seems to make sense. A sequence of pulses carrying a constant electric field forces current carriers to accelerate repeatedly provided the frequency of the pulses is sufficiently low for charged to come at rest. A decelerating system emits its energy as positive energy photons whereas the accelerating system might receive its energy by emitting negative energy photons if deceleration and acceleration are genuine time reversals of each other.
2. Negative energy photons are absorbed by any system which contains (possibly many-sheeted) population inverted lasers with appropriate excitation energy when bosonic particles return to their ground states. If sufficiently many bosonic particles return to the ground state, a phase transition return to the ground state occurs and is analogous to induced emission. Large number of positive energy photons are generated and a weak negative energy control signal is amplified to much stronger positive energy signal. The resulting energy is identifiable as "free energy".

The generation of negative energy photons breaks second law. In TGD Universe second law however holds true at a given p-adic length scale only in time scales longer than the corresponding p-adic time scale. This means that field patterns having a duration below the relevant p-adic time scale can appear as negative energy topological light rays. Sharp electric pulses carrying a constant electric field are ideal in this respect.

Suppose that electric pulses are fed into a binary coil for which the loops of the primary and secondary coils are on top of each other and very near to each other. Electric pulses induce currents in the primary coil. Due to the large mutual inductance between loops of the primary and secondary coils composing the binary coil, the current generated by the pulse in the primary loop is transmitted inductively to the nearby second loop, which in turn generates a positive feedback

to primary. Thus the current is amplified and the propagation of the electric pulse induces a propagation of large rapidly varying currents in coils rotating in opposite direction so that the magnetic flux inside the binary coil is small. First of all, this means that the sequence of electric pulses induces a currents through the two components of the binary coil by effectively reducing the inductance of the coil. Secondly, the amplification of the current means amplified acceleration of the current carriers optimal for the generation of negative energy photons as time reversed brehmstrahlung.

There are good reasons to expect that living matter has discovered the analogs of binary coils long before humans, even before Tesla. Binary structures, such as DNA double strand and cell membrane consisting of two lipid layers, are good candidates for the counterparts of binary coils and might play key control in the bio-control by serving as generators of negative energy photons in turn controlling the generation of positive energy photons.

### Do electric pulses generate scalar wave pulses?

Interesting questions are related to the behavior of the electric field inside ordinary coils, binary coils, and in particular bi-filar coils. It seems that the expressive power of Maxwell's theory might not be enough here. It seems that the electric pulses propagating in any circuit could correspond to TGD counterparts of Tesla's scalar wave pulses.

1. The unipolar electric field is discontinuous at the ends of an ideal square pulse. In Maxwell's equations the rotor of the magnetic field equates to the sum of the current term  $j$  and the displacement current  $\partial E/\partial t$ . Either an infinitely sharp induction peak is allowed in the magnetic field or the displacement current must be compensated by the current term. In realistic case there is short rising time during which electric field increases.
2. In Maxwell's electrodynamics a very high (ideally infinitely strong instantaneous) ohmic current would be needed to compensate the displacement current. This seems implausible. In TGD however vacuum charges and currents are possible. The electric square pulse is analogous to a moving capacitor and the charges of the capacitor plates correspond to vacuum charges. At the level of space-time geometry the plates would correspond to propagating edges of the 3-surface. The induced electric field  $E_{rot}$  would induce a current pulse, whose direction would change in the middle of the magnetic pulse.
3. TGD indeed predicts the existence of scalar wave pulses [K8]. These pulses represent electric flux quanta, 3-surfaces inside which there is an almost constant longitudinal electric field. A capacitor moving with the velocity of light would be the analogy. These solutions are not possible in Maxwell's theory. Because also the pulses moving in circuits are very similar, there is a temptation to identify them as scalar wave pulses. In this case the effective propagation velocity is reduced below light velocity by the interaction with matter. Intuitively, the particles topologically condensed in the region of 3-surface representing the pulse make it massive and slow down the effective speed of propagation.
4. The first guess that a scalar wave pulse of duration  $\tau$  results when a voltage in circuit is switched on for time  $\tau$ , does not make sense since the pulse could last for an arbitrarily long time and have arbitrarily long length. Experimental study of a pulsed system involving a FET serving as a switch and a capacitor in parallel suggests that a positive energy scalar wave pulse results in switching on and has a duration equal to the rising time  $\tau_r$  of the voltage. Negative energy scalar wave pulse moving into geometric past results in the switching off of the voltage. In switching on the capacitor absorbs a negative energy scalar wave pulse coming from geometric future and is neutralized. In the similar manner the capacitor in future re-charges by absorbing positive energy pulse from the geometric past.
5. An interesting question is whether scalar wave pulses propagating through (say) bi-filar coil could increase its capacitance dramatically by providing primary and secondary coils with opposite vacuum charges. If scalar wave pulse collects also ordinary charge on its "plates" when it moves through the system, it could become a dynamical capacitor, and transform also the system through which it traverses to a capacitor. The experimentation with bi-filar

coil indeed forces to conclude that its capacitance can be much larger than expected on basis of geometric arguments.

6. One might imagine that the scalar wave pulses could leak out of the system. For instance, this might happen if the second end of the coil is free. Tesla indeed reported a production of scalar wave pulses using a transformer whose primary coil was feeded by a sequence of unipolar pulses. These pulses were amplified in a secondary coil in whose second end was free. Abnormally high voltage amplification with no current in secondary coil was reported [H56].
7. If the propagation velocity of the scalar wave pulse is light velocity, the time  $T$  would be the time taken by the pulse to propagate through the first half of the bi-filar coil:  $T = Z/v$ , where  $Z$  is the length of the wire in the bi-filar coil and  $v = c$  is light velocity. For  $v = c$   $T$  would be 3.3 ns if the length of the wire is 1 meter. The interaction with the matter induces inertial effects and is expected to reduce the effective propagation velocity of the scalar wave pulse representing the electric pulse to  $v < c$ .

### Could electric pulses in circuits correspond to separate space-time sheets?

Scalar wave pulses could correspond directly to the space-time sheets of electric flux quanta moving with light velocity predicted by TGD [K8] rather than being regions of constant electric field at the space-time sheet of wire. These flux quanta would move along wire and have join along boundaries contacts connecting the space-time sheet of the flux quantum with the boundaries of small co-moving holes associated with the circuit's space-time sheet. Charged particles could flow to the flux quantum along these bridges at the first end of the electric flux quantum, accelerate there practically without dissipation, and flow possibly also back at the second end of the flux quantum. The direction of the flow would be determined by the sign of the charge. This would allow anomalous acceleration of the current carriers making it possible to emit negative energy photons up to energies determined by the voltage difference associated with the flux quantum. The lowering of the effective propagation velocity would be a genuine quantum effect based on the same mechanism as the lowering of the effect phase velocity of topological light rays.

The energies of the "acceleration radiation" would be quantized since the quanta would have frequencies  $f_n = n/T_p$ , where  $T_p$  is the duration of the scalar wave pulse. The duration of the scalar wave pulse should correspond to a natural time scale associated with the generation of the scalar wave pulse. For instance, if the scalar wave pulse is generated when a voltage in a circuit is rapidly switched on, the scalar wave pulse would naturally correspond to the rising time  $\tau_r$  of the voltage. This quantization is a unique signature of the negative energy radiation.

Scalar wave pulse is like a moving capacitor and should be attracted or repelled by a real charged capacitor depending on the sign of its polarization. Therefore scalar wave pulse could be reflected from a heavily charged capacitor and begin to move forth and back around the loop connecting the plates of the capacitor in a circuit. The pulse could even move between capacitor plates forth and back. If binary coil is coupled between the capacitor the pulse should move forth and back through it. If scalar wave pulses correspond to separate space-time sheets they can leak out of the system. The open ends of the secondary coils used by Tesla in his transformers might be the places where the leakage occurs. The emission of a new kind of radiation observed by Modanese and Pokleznov [H43] to accompany the discharge of a capacitor for which the negatively charged plate was super-conducting might represent the emission of scalar wave pulses [K8].

### Scalar wave pulses as producers of phase conjugate waves and time mirror mechanism

Tesla transformers use ordinary coils as primary coils and an open coil as a secondary coil. On basis of his experimental work Tesla claimed that Tesla transformers allow an anomalously high voltage amplification. Strangely, Tesla found no current in the secondary coil but the transformers induced charging of various metallic objects in large regions surrounding the transformer. This effect was able to penetrate even through Faraday cage.

The bi-filar coils discovered by Tesla [H53], which are feeded by sharp unipolar electric pulses carrying constant electric field and analogous to moving capacitors, occur repeatedly in various free energy devices. Caduceus coil is second binary coil appearing very often. This would suggest

that coils with a binary structure somehow produce phase conjugate laser waves (negative energy topological light rays accompanied by negative energy photons). These in turn would induce the dropping of bosonic charged particles to larger space-time sheets as a phenomenon analogous to induced emission when the intensity of negative energy photons is above some threshold.

In many-sheeted space-time particles topologically condense at all space-time sheets having projection to given region of space-time so that this option makes sense only near the boundaries of space-time sheet of a given system. Also p-adic phase transition increasing the size of the space-time sheet could take place and the liberated energy would correspond to the reduction of zero point kinetic energy. Particles could be transferred from a portion of magnetic flux tube portion to another one with different value of magnetic field and possibly also of Planck constant  $h_{eff}$  so that cyclotron energy would be liberated.

In the following early version of the model assigning metabolic energy quantum to the dropping of protons is considered. In [K55] a model of metabolism associating the metabolic energy quantum to the change of cyclotron energy is discussed. The challenge is to understand how square pulses propagating both in ordinary and binary coils manage to produce phase conjugated light.

What is so special in the unipolar electric pulses circulating in binary coils? If one wants to produce negative energy photons, one must break the second law of thermodynamics. TGD predicts that in a given n-ary p-adic length scale  $L(n, k)$  (size of the space-time sheet) this is possible below the n-ary p-adic time scale  $T(n, k) = L(n, k)/c$ . One must only produce pulses having duration shorter than the p-adic time scale  $T(n, k)$ . The sharp electric pulses are excellent candidates for this kind of pulses since they accelerate the current carriers and during this period they can emit negative energy photons as "acceleration radiation" with quantized frequencies  $f_n = n/T_p$ ,  $T_p$  the duration of the scalar wave pulse. If the pulses correspond to their own space-time sheets dissipation is negligible and the intensity of acceleration radiation is maximal.

An especially interesting situation arises when the energies of the negative photons radiated by the charged particles accelerated inside the scalar wave pulse correspond to the increment of a zero point kinetic energy for some charged particle when it drops to a larger space-time sheet. In this case the negative energy radiation could make possible time mirror mechanism by generating a cascade like dropping of charged particles and an amplified emission of positive energy photons. This hypothesis is testable by choosing suitably the value of the rising time  $\tau_r$ .

There are natural time scales associated with pulsed binary coils. One class of important frequencies would correspond to harmonic multiples for the frequency  $f = 1/\tau_p$ , the duration of electric pulse. Second time scale corresponds to the frequency defined by the duration of the scalar wave pulse and is assumed to correspond to the rising time  $\tau_r$  of the electric pulse. A second important time scale is the time interval between the pulses which must be so long that the charges have time to come at rest. One expects that this time scale is of the order of  $\tau = L/R$ , where  $L$  and  $R$  characterize the primary of the binary coil. A third important time scale is the duration of the magnetic pulses generated in the pulsed binary coil. Besides these time scales important time scales are the time scales determined by the basic parameters  $L, C, R$  of the primary (secondary) of the binary coil.

As far as I know, Tesla used ordinary coils in his transformers and observed anomalous voltage amplification and other strange effects. If the time interval between voltage pulses is so long that the charges dissipate their energy, charges are indeed accelerated in a constant electric field and the emission of negative energy photons should occur. Hence also ordinary pulsed coil, perhaps when used as the primary of the Tesla transformer, could allow the exotic effects due to the generation of negative energy photons. In particular, if this process leads to the phase transitions increasing the conductivity of the wire then the current in the primary coil increases and therefore also the current in the secondary coil increases beyond the value predicted by Maxwell's theory.

### Bio-systems and unipolar pulses

One might think that besides Tesla also bio-systems might have invented the sharp pulses as a manner to break second law temporarily and produce negative energy topological light rays crucial for all basic mechanisms in TGD based quantum biology and theory of consciousness. Perhaps one function of nerve pulse is to produce phase conjugate waves and perhaps nerve pulse can be switched on by a scalar wave pulse reducing the membrane potential below the critical value.

This suggests the existence of biological variants of binary coils. Bio-systems are full of binary

structures such as DNA double strand and cell membrane (consisting of two lipid layers). It is tempting to think that DNA double strand is a variant of bi-filar coil in which scalar wave pulses propagate along strand (associated with say gene) and return along the conjugate strand. Also now the effective inductance of the system would grow from zero to some maximum value and return back to zero and phase conjugate light would be generated. As a matter fact, the TGD based model for bio-photons lead to the hypothesis that the strand/conjugate strand generates positive/negative energy MEs and that these MEs move in opposite directions along strands [K34].

#### 5.2.4 Could negative energy photons induce the transition to effective superconductivity?

The generation of negative energy photons involves temporary breakdown of the second law. Therefore the minimization of the resistance of the relevant part of the circuit, say binary coil, should be favorable for the effect.

TGD based new physics might provide a possible mechanism reducing the resistance. If part of the current carrying electrons of the bi-filar coil drops down to the larger space-time sheets, where they propagate as Cooper pairs, the resistance of the system is reduced. The research group led by Hafedh Abdelmeik has found that the electric conductivity of axon grows by a factor of order 10 below a certain critical temperature, which is in the range 30-40 C of physiological temperatures [J16]. The TGD based model [K60] explains the findings correctly at quantitative level.

A variant of this mechanism might be at work also in the case of electric circuits if appropriate conditions are satisfied.

1. The model for the realization of intentionality and motor activity [K82] relies on a process, which proceeds from long to short time and length scales, much like a desire for some action in an organization proceeds from boss to the bosses at lower level. In the same manner a hierarchy of phase transitions could proceed from longer to shorter length and time scales and reduce the resistance and increase the upper limit for the energy of negative energy photons.
2. The pulses propagating in the binary coil could produce already in the normal situation a sufficient amount of negative energy photons at low frequencies to induce a phase transition increasing the conductivity. The growth of the intensity of the negative energy photons emitted at higher frequencies could in turn induce a similar phase transition in a shorter p-adic length scale and corresponding to higher zero point kinetic energy. At every stage the negative energy photons could first cool the system so that the phase transition occurs more easily. The dropped Cooper pairs would in turn increase the portion of the supra current flowing at the ground state space-time sheet and thus conductivity.

### 5.3 The scalar waves of Tesla in TGD framework

The scalar waves or so called non-Hertzian waves of Nikola Tesla belong to the fringe region of science. Many proponents of free energy believe that scalar waves might provide a basis for a new energy and communication technologies. Tesla himself was isolated from the official science and found no place in text books because his hypothesis about scalar waves did not fit within the framework of the Maxwell's electrodynamics. Personally I justified my personal prejudices against scalar waves by the observation that the formulations for the notion of scalar waves that I had seen seemed to be in a conflict with the cherished gauge invariance of gauge theories. The discussions with a Finnish free energy enthusiast Juha Hartikka however led me to reconsider the status of the scalar waves.

The surprise was that the non-Hertzian waves of Tesla might be possible in TGD framework. One can imagine two alternative manners to obtain them.

1. TGD allows so called massless extremals (MEs, topological light rays) as non-linear generalization of Maxwellian plane waves. They are characterized by light-like wave vector and polarization vector orthogonal to it and these vectors can also depend on space-time position [K10]. The most general wave is a pulse with arbitrary profile moving along ME with light-velocity along them and preserving its shape.



Since TGD space-time is many-sheeted one can take two waves of this kind on top of each other in the sense that their  $M^4$  projections intersect in some region of  $M^4$ . The effective space-time is defined by a piece of Minkowski space with effective metric which is sum of  $M^4$  metric and deviations of the metrics of sheets from  $M^4$  metric. Effective gauge potentials are sums of the induced gauge potentials. For two MEs the potentials at the two sheets and if the wave vectors can be chosen to be in opposite direction in which case one obtains an effective standing wave with non-vanishing net energy but vanishing 3-momentum and classical spin. Since MEs can carry light-like charge current the resulting system carries non-vanishing charge density and vanishing current. Fourier transforms of the pair give rise to massive spinless states having identification as scalar waves possibly carrying em charge.

In TGD framework classical gauge boson fields of standard model correspond two-sheeted structures - perhaps pairs of MEs connected by wormhole contact pairs having interpretation as gauge boson. One can consider the possibility that the classical space-time correlate for gauge bosons massivation at the level of MEs is this kind of pair of spacetime sheets. For massive gauge bosons the wave vector directions of the two sheets would be opposite in the rest system and spin would be vanishing.

2. The original proposal could have been inspired by the electric-magnetic duality of TGD suggesting a large number of solutions of field equations representing constant energy density configurations of electric field assignable to bio-electrets, which would be in a well-defined sense dual to the magnetic flux tube structures with analogous properties. Also classical gravitational fields generated by classical field energy could be important in the living matter. One must however take this proposal with a big grain of salt since there is no proof for the actual existence of this kind of solutions. Furthermore, one can obtain TGD counterparts of scalar waves as pairs of MEs.

In the following only the candidate for scalar waves obtained as single-sheeted space-time is considered.

### 5.3.1 The properties of the scalar waves

Perhaps the most important properties of the scalar waves are following.

1. Scalar waves involve some kind of oscillatory process in the direction of the propagation of the wave. The analogy with sound waves suggests that the oscillation could relate to charge density, or more generally to 4-current in the direction of the wave. Even massless extremals (MEs), which are essentially topological light rays, involve vacuum current and vacuum charge density which oscillates in the direction of propagation.
2. Scalar waves are believed to carry electric field in the direction of the wave motion so that the identification of MEs as scalar waves is not possible. The presence of only electric field means that scalar wave is characterized solely by the scalar potential. This kind of solution is excluded by the gauge invariance and linearity of Maxwell's electrodynamics in vacuum.

### 5.3.2 Could nonlinearity of TGD allow scalar waves?

One is led to ask whether the nonlinearity of TGD might allow existence for scalar waves.

1. In TGD based electrodynamics  $CP_2$  coordinates are the primary dynamical degrees of freedom gauge fields being secondary dynamical variables induced from the spinor curvature of  $CP_2$ . Field equations are extremely nonlinear allowing among other things vacuum 4-currents (even Faraday's unipolar generator involves vacuum charge density changing its sign when the direction of rotation of magnet changes its sign). This gives hopes about finding solutions of field equations with the properties assigned to the hypothetical scalar waves.
2. Interestingly, in TGD framework the canonical symmetries of  $CP_2$  are dynamical symmetries and act as isometries of WCW of 3-surfaces. Canonical transformations act formally as  $U(1)$  gauge transformations but, rather than being gauge symmetries, they are dynamical

generating new physical configurations and are partially responsible for the quantum spin glass degeneracy of the TGD universe. As a matter fact, also diffeomorphisms of  $M^4$  act as dynamical symmetries in the lowest order.

3. Magnetic flux tubes represent fundamental solutions of field equations and the simplest magnetic flux tubes can be characterized as maps from a region of a 2-dimensional Euclidian hyperplane  $E^2$  of Minkowski space to a geodesic sphere  $S^2$  of  $CP_2$ .
4. Electric-magnetic duality is a fundamental symmetry of the WCW geometry. Therefore there should exist solutions dual to the magnetic flux tubes carrying only electric fields and perhaps allowing interpretation as waves. These solutions would be characterized by a map from a region of the Minkowskian hyperplane  $M^2$  of Minkowski space to  $S^2$ . This kind solution ansatz makes sense since it formally provides the solutions of a field theory from  $M^2$  to  $S^2$ .

### 5.3.3 Lowest order solution ansatz

One can write the field equations explicitly. They are however extremely nonlinear and without physical intuition one cannot say much about the solution spectrum of these equations. One can however make simplifying assumptions to get grasp to the problem.

1. The effect of classical gravitation can be assumed to be extremely weak except possibly at some singular regions associated with the solutions.
2. In Maxwellian theory without sources gauge current vanishes identically. This would suggest that it is good to start from a zeroth order solution ansatz with this property so that the non-vanishing of the vacuum current would be solely due to gravitational effects. It deserves to be noticed that Tesla proposed also that non-Hertzian radiation fields involve a kind of radiation charge.

In principle, one can imbed a portion of any solution of Maxwell's equations in empty space as a space-time sheet (note the occurrence of the topological quantization) using  $M^4$  coordinates as preferred coordinates. Field equations are satisfied in the lowest order in  $R^2$ . The canonical symmetries of  $CP_2$  act as dynamical symmetries for these solution ansätze and one obtains infinite degeneracy of the space-time surfaces representing the same Kähler field.

3. Constant electric field represents the simplest field configuration one can imagine. Therefore it is reasonable to start with this kind of solution ansatz and to look whether gravitational corrections affect the solution and bring in the wave aspect.
4. Since wave motion is hoped to result, it is useful to choose the space-time coordinates in an appropriate manner. Light-like coordinates  $(x^+, x^-, x, y)$  of  $M^4$  are thus very natural. They are defined by the conditions

$$t = (x^+ + x^-)/2 \quad , \quad z = (x^+ - x^-)/2 \quad ,$$

with  $(t, x, y, z)$  referring to the linear Minkowski coordinates such that  $t$  is time coordinate. In these coordinates the line element of  $M^2$  has the form  $ds^2 = -2dx^+dx^-$  so that one has  $g_{+-} = -1$ .

5. Using the spherical coordinates  $(u = \cos(\Theta), \Phi)$  for the geodesic sphere  $S^2$  of  $CP_2$ , the zeroth order solution ansatz has the following form:

$$u \equiv u_0 = \omega_1 x^+ \quad , \quad \Phi \equiv \Phi_0 = \omega_2 x^- \quad . \quad (5.3.1)$$

Since electromagnetic,  $Z^0$  and color fields are proportional to Kähler form for the solution type considered, one can restrict the consideration to the induced Kähler form. Denoting the Kähler form of  $CP_2$  by  $J_{kl}$ , by noticing that  $S^2$  Kähler form is given by  $J_{u\Phi} = 1$  (forgetting the precise normalization factor), and using the expressions  $[s_{uu} = R^2/(1 - u^2), s_{\Phi\Phi} = R^2(1 - u^2)]$

for the metric of  $S^2$ , one can write the induced line element and the non-vanishing component of the induced Kähler form as

$$\begin{aligned} ds^2 &= -2dx^+dx^- + \frac{R^2\omega_1^2}{1-u^2}(dx^+)^2 + R^2\omega_2^2(1-u^2)(dx^-)^2 - dx^2 - dy^2 \ , \\ J_{+-} &= \partial_+u\partial_-\Phi = \omega_1\omega_2 \ , \\ J^{+-} &= \frac{\omega_1\omega_2}{\det(g)} \ . \end{aligned} \tag{5.3.2}$$

Since the determinant of the induced metric is constant,  $J^{+-}$  describes constant electric field and that Kähler current  $j^\alpha$  is vanishes. This means that Maxwell's equations hold true in the zeroth order approximation as required.

Apart from the normalization factors the energy momentum tensor in the longitudinal degrees of freedom is given by

$$T^{\alpha\beta}(long) = g^{\alpha\beta}L/4 \ ,$$

In the transversal degrees of freedom similar expression but with opposite sign holds true. Here  $L$  is Kähler action which is essentially electric energy density and constant.

In  $M^4$  degrees of freedom the field equations express conservation of the energy momentum currents and are satisfied to order  $R^2$  since the action is constant. These equations imply that action density is constant. This forces to ask whether all perturbatively constructible solutions represent a constant Kähler electric field locally.

In  $CP_2$  degrees of freedom field equations involve a sum of two terms: the first term involves the contraction of the energy momentum tensor with the second fundamental form whereas the second term involves Kähler current. Since Kähler current vanishes, the latter term vanishes and one can say that field equations are satisfied in zeroth order approximation (the term involving energy momentum tensor is proportional to  $CP_2$  length squared and thus small). For exactly vanishing vacuum current the field equations would reduce to the equations for a minimal surface:

$$g^{\alpha\beta}D_\beta\partial_\alpha h^k = 0 \ , \tag{5.3.3}$$

where the imbedding space coordinates  $h^k$  corresponds to  $u$  and  $\Phi$  now. The same equations result also in  $M^4$  degrees of freedom by requiring that the terms of order  $R^2$  in the equation for the energy momentum conservation vanish.

This equation is not satisfied exactly as is easy to see. The non-vanishing components of the trace of the second fundamental form are given by

$$\begin{aligned} g^{\alpha\beta}D_\beta\partial_\alpha u &= -\{\frac{u}{\Phi}\}_{\Phi} \omega_2^2 \times [1 - g^{++}\omega_1^2 R^2/(1-u^2)] \ , \\ g^{\alpha\beta}D_\beta\partial_\alpha \Phi &= -\{\frac{\Phi}{u}\}_{\Phi} \omega_1\omega_2 \times [1 - g^{--}\omega_2^2 R^2(1-u^2)] \ . \end{aligned} \tag{5.3.4}$$

Here  $\{\frac{\alpha}{\beta}\}_{\gamma}$  denote the components of the Riemann connection for sphere. It is seen that the connection term gives contributions which vanish only at  $u = 0$  which corresponds to the equator of the geodesic sphere  $S^2$ . At poles the minimal surface condition fails to be satisfied.

### 5.3.4 First order corrections to the solution ansatz

To take into account gravitational corrections one must modify the solution ansatz in such a manner that  $x^-$  does not appear in the field equations at all: this guarantees that field equations reduce to ordinary differential equations. The modification is following:

$$u = u_0 + u_1(x^+) \ , \quad \Phi = \Phi_0 + \Phi_1(x^+) \ . \tag{5.3.5}$$

The modification affects the electric field and vacuum current and allows the compensation of the terms resulting from the contractions of the energy momentum tensor and vacuum current. The modification means that wave equations are still satisfied for  $u$  and  $\Phi$ . Note that second fundamental form does not contain second derivative terms in the lowest order approximation.

The derivation of the differential equations for  $u_1$  and  $\Phi_1$  is completely straightforward but requires some patience with numerical factors (reader should check sign factors and numerical factors).

1. Calculate the the current contraction term

$$j^\alpha [J_r^k \partial_\alpha h^r - J^\mu_\alpha \partial_\mu h^k]$$

and energy momentum tensor contraction term

$$T^{\alpha\beta} D_\beta \partial_\alpha h^k$$

and equate these terms. Effective two-dimensionality makes the explicit calculations relatively simple.

2. The equations for  $u$  and  $\Phi$  in terms of  $j^\pm$  read as

$$j^-(1 - u_0^2) + j^+ \epsilon_1 \epsilon_2 = \left\{ \frac{u}{\Phi} \right\} \frac{K \epsilon_2^2}{2} \equiv X_1 \quad ,$$

$$j^+ \frac{1}{(1 - u_0^2)} j^- \epsilon_2^2 = -2 \left\{ \frac{\Phi}{u} \right\} K \epsilon_1 \epsilon_2 \equiv X_2 \quad ,$$

Here the notations  $\epsilon_i = \omega_i R$  and  $K = \omega_1 \omega_2^2$  are used. Linear second order differential equations are in question with the right side serving as an inhomogeneity term.

3. One can solve  $j^+$  and  $j^-$  from these equations to get

$$\begin{pmatrix} j^+ \\ j^- \end{pmatrix} = \frac{1}{\epsilon_1 \epsilon_2^3 - 1} \times \begin{pmatrix} \epsilon_2^2 & -(1 - u_0^2) \\ -1/(1 - u_0^2) & \epsilon_1 \epsilon_2 \end{pmatrix} \times \begin{pmatrix} X_1 \\ X_2 \end{pmatrix} \equiv \begin{pmatrix} Y_1 \\ Y_2 \end{pmatrix}$$

From this form one can see that  $j^-$  becomes singular at  $u_0 = \pm 1$  as  $1/(1 - u_0^2)$  which means that light-like vacuum current is generated. The physical interpretation is that vacuum charge density at these points which correspond to the boundaries of the solution acting as the source of the vacuum electric field is in question.

4. One can calculate  $j^\pm$  by calculating the covariant divergence of the induce Kähler field in the lowest non-trivial order. The calculation gives the following expression

$$\begin{pmatrix} j^+ \\ j^- \end{pmatrix} = \omega_1 \begin{pmatrix} u_0 \partial_+^2 u_1 + \epsilon_1 \epsilon_2 (1 - u_0^2) \partial_+^2 \Phi_1 \\ \omega_1 \epsilon_2 \partial_+^2 u_1 - \epsilon_1 (1 - u_0^2) \partial_+^2 \Phi_1 \end{pmatrix}$$

5. For  $u_1$  one finds the equation

$$\begin{aligned} \partial_+^2 u_1 + \epsilon_1 \epsilon_2^2 \omega_1 u_0 \partial_+ u_1 &= \frac{1}{\omega_1} \times (Y_1 + \epsilon_1 Y_2) \\ &= \frac{\omega_2^2}{2} \frac{\epsilon_1}{\epsilon_1 \epsilon_2^3 - 1} \times u_0 \times \left[ -\epsilon_2^4 (1 - u_0^2) + \epsilon_1 \epsilon_2 (-2 + \epsilon_1) - \epsilon_1^3 \epsilon_2 \frac{1}{1 - u_0^2} \right] . \end{aligned} \quad (5.3.6)$$

This equation reduces to a first order differential equation for  $u_1$  and one can solve it by variation of integration constants. The singularity at  $u = \pm 1$  implies a logarithmic singularity of the derivative

$$\partial_+ u_1 \sim \log(1 - u_0^2)$$

but  $u$  remains finite as it should.

6. One can integrate  $\Phi_1$  from the second order inhomogenous and linear equation

$$\begin{aligned} \partial_2^+ \Phi_1 &= \frac{1}{\epsilon_1 \epsilon_2 (1 - u_0^2)} [j^- - \omega_2 \partial_+^2 u_1] \quad , \\ j^- &= \frac{\omega_1 \omega_2^2 \epsilon_1 \epsilon_2}{2(\epsilon_1 \epsilon_2^3 - 1)} \times u_0 \times \left[ 1 - \frac{2\epsilon_1^2}{1 - u_0^2} \right] \quad , \end{aligned} \tag{5.3.7}$$

once the solution for  $u_1$  is known. Note that the most singular part corresponds to  $u_0/(1-u_0^2)^2$  type term and one obtains logarithmic singularity also now.

### 5.3.5 Properties of the solution ansatz

The form of the differential equations for the first order corrections allows to conclude that the North and South poles of the geodesic sphere  $S^2$  (the points  $u_0 = \pm 1$ ) correspond to singularities of the solution. Both the components of the induced metric and the induced Kähler form become singular at these points. This means that classical gravitation becomes important near these points. These points correspond in the lowest order approximation to the lines  $x^+ = \pm 1/\omega_1 \equiv T$  plus possibly the lines obtained by continuing the solution by assuming that  $x^- = \text{constant}$  lines define a motion identifiable constant rotation along the big circle from  $\theta = 0$  ( $x_+ = T$ ) to  $\theta = \pi$  ( $x_+ = -T$ ) continuing in the same manner to  $\theta = 0$  at ( $x = 2T$ ) and so on. Therefore gravitational effects induce a periodical behavior of the solution such that gravitational effects become strong at  $x^+ = (2n + 1)T$ .

In the next order electric field is not constant anymore and vacuum current is generated. The contravariant component of electric field, being proportional to  $1/\partial_+ u$  near singularity, vanishes at the singularity whereas the tangential component  $j^-$  of the vacuum current diverges. The vacuum current should generate coherent photons.

By a straightforward calculation one finds that the curvature scalar behaves as  $R \propto 1/(1 - u_0^2)$  at the singularities so that the energy density of vacuum becomes singular and could generate a coherent state of gravitons. Since Einstein tensor vanishes identically in two-dimensional case, the longitudinal components  $G^{++}$ ,  $G^{--}$  and  $G^{+-}$  of Einstein tensor vanish. The components of Einstein tensor in transverse degrees of freedom are given by  $G^{alpha\beta} = -g^{\alpha\beta} R/2$ . Therefore the energy momentum tensor defined by Einstein's equations would involve only space-like momentum currents. The singularity is amplified by the fact that field energy couples to the classical gravitation with coupling which is  $10^8$  times stronger than the ordinary gravitational coupling. The singularity might relate to the claimed gravitational anomalies associated with the scalar waves.

As already found, Einstein tensor and gauge current have no components in the direction of  $x^+$ . Energy-momentum tensor behaves as  $1/\det(g)^{3/2}$  at the end points of the interval  $[-T, T]$  and thus vanishes. Therefore conservation laws allow to restrict the solution into the  $x^+$  interval  $(-T, T)$ . This restricted solution defines geometrically a particle like structure moving in  $x^-$  direction but with fields moving in  $x^+$  direction so that one would have rather exotic kind of particle-wave dualism. In accordance with the quantum-classical correspondence, one could interpret this as classical space-time representation of the particle wave duality and the solution would be a particular example of topological field quantization. Tesla stated that this non-Hertzian waves did not weaken with distance. This is indeed the case if one interprets the signal as a finite piece of space-time moving with light velocity.

### 5.3.6 More general solutions representing electric field of constant action density are possible

The solution ansatz just discussed represents a constant electric field in a region of space-time moving with light velocity in the direction of  $x^-$  coordinate. Also ordinary constant electric field

is a possible solution and is constructed iteratively in an essentially identical manner by starting from the solution ansatz

$$u = kz \ , \ \Phi = \omega t \ . \quad (5.3.8)$$

Also now Kähler current vanishes in the lowest order and action density is constant so that lowest order field equations are satisfied. Higher order corrections are obtained using the ansatz  $u_1 = u_1(z)$ ,  $\Phi = \Phi_1(z)$ . Minimal surface condition gives now essentially same kind of expressions for  $u_1$  and  $\Phi_1$ . Also now the singularities where gravitational interaction becomes strong are at  $u = \pm 1$  and one can select the solution to represent a membrane like structure with thickness  $L = 2/k$ .

Cell membrane space-time sheets are good candidates for the realization of this kind of solutions. If so, one might expect that classical gravitational effects become important at the boundaries of the cell membrane. More generally, bio-systems are electrets and the proposed solution type might provide a fundamental model for bio-electrets. In particular, electro-gravitational effects due to the energy of the classical electric field might be of importance.

This observation relates interestingly to the sol-gel phase transitions occurring inside cell. In these transitions large scale bound states of water molecules are formed and could make possible macro-temporally quantum coherent systems able to perform quantum computations in time scales of order say .1 seconds. These bound states would be characterized by spin glass degeneracy broken only by the classical gravitation and spin glass degeneracy would make these bound states long lived. In the case of the proposed solution ansätze spin glass degeneracy corresponds to the canonical symmetries of  $CP_2$  generating new solutions representing constant electric field.

Also  $M^4$  diffeomorphisms are symmetries of the field equations broken only by the classical gravitation. Approximate diffeomorphism invariance means that one obtains solutions for which the lines of electric flux are curved and only the action density stays constant. In the case of magnetic flux tubes this symmetry makes possible curved magnetic flux tubes. Both electric fields and the magnetic flux tubes are fundamental for the TGD based model of living matter and relate deeply to the electric-magnetic duality symmetry and to the quantum criticality predicting that magnetic and electric space-time regions having opposite signs of Kähler action play a role similar to the ice and water regions at critical point of water, are important physically.

### 5.3.7 Support for Tesla's scalar waves/classical $Z^0$ MEs

Recently I learned from Hans-Poul Veldhuyzen van Zanten that E. Podkletnov and G. Modanese have constructed a device [H43] in which a super-conducting ceramic cathode and a copper anode cause electrical discharges in low pressure gases, at temperatures between 50 and 70 K. The voltage used is 2000 kV. Peak currents are of order  $10^4$  A. Cathode and anode have radii of 10 cm and their distance varies between 15 and 40 cm. There is also a magnetic field of .9 Tesla present inside the cylindrical chamber to concentrate the discharge to a smaller area. In discharges at voltage above 500 kV two new phenomena were observed. First, discharge does not look like a spark but like a flat, glowing discharge originating from the whole surface of the super-conductor. Secondly, a radiation pulse is emitted at the discharge which propagates orthogonally to the cathode, towards the anode and beyond it, in a collimated beam, apparently without an attention. Radiation pulse carries away an energy of  $10^{-3}$  J at least. It is concluded that the radiation in question cannot be ordinary electromagnetic radiation.

The anomalous radiation was measured using various penduli at the line connecting the centers of cathode and electrode and hanging from a cotton string inside glass cylinders under vacuum. The radii of spheres were 10-25 mm and located at distances 6 m and 150 m from the installation. Various materials for the spheres were used: metal, glass, ceramics, wood, rubber, plastic. It was found that the impact on pendulum did not depend on the material but only on the mass of the pendulum which was in the range 10-50 g. Pendulum did not show any signs of heating. Measurements of the impulse taken at close distance (3-6 m) and large distance (150 m) gave identical results. The pulses were not absorbed by the media or at least, the losses of energy were negligible. The force beam does not seem to diverge and its borders are clear-cut and the width of the beam is that of the super-conducting emitter. If the pulse propagates in air, some energy should be depleted from it and lead to the weakening of the pulse. The observations of the air in the path of pulse only show that brief forward and backward movement of particles occurs.

The radiation appears to propagate through brick walls and metal plates without a noticeable absorption but this is not due to weak coupling with matter. Ordinary electromagnetic radiation cannot be in question. The assumptions that the radiation satisfies  $E = cp$  dispersion relation and that the pulse given to the pendulum is due to the absorption of energy and momentum of radiation leads to a contradiction. For a pendulum of 18.5 g, the kinetic energy of the pendulum was of the order of  $10^{-4}$  J whereas the momentum was of the order of  $10^{-3}$  kg m/s. If this momentum had to be imparted from the beam, its total energy should be larger than the total energy available in the discharge,  $10^6$  J in maximum. The conclusion made in [H43] is that the radiation does not obey the dispersion relation of massless particles. On the other hand, if the net energy and momentum of the pendulum correspond to the total energy and momentum for quanta of radiation absorbed by the pendulum, the quanta must be tachyonic since one has  $E = 10^{-4} J \ll pc = 3 \times 10^5$  J, which suggests that absorption is not the mechanism. Also the fact that radiation does not weaken with distance with a detectable manner suggests the same.

The force is proportional to the mass of the pendulum sphere but the interpretation as a gravitational force is excluded already because of the strength of the effect. Equivalence Principle states also that the gravitational force depends only on the gravitational mass of the particle, not its particular state. The force is also repulsive.

Consider now a TGD based explanation for the effect.

1. The radiation could correspond to a massless extremal (ME, 'topological light ray') or TGD counterpart of the longitudinal scalar waves of Tesla. The classical field involved could be either electromagnetic or  $Z^0$  type. MEs represent classical completely collimated radiation propagating with light velocity with pulse shape being arbitrary and preserved. Tesla wave represents longitudinal pulse of electric or  $Z^0$  electric) field propagating with light velocity. At least  $Z^0$  type and perhaps also em MEs and scalar waves do not care about Faraday cages: the classical radiation is simply at another space-time sheet. This fits with the observation that the pulse of radiation goes through various obstacles without absorption.
2. Electromagnetic Tesla's scalar waves are favored because their emission could be interpreted as a decay of the electric field of the capacitor by the emission of scalar waves carrying away pieces of space-time containing a constant electric field with intensity equal to the local intensity of the electric field between the capacitor plates. For the scalar wave pulses the quantization of the electric flux analogous to that of magnetic flux suggests that the condition

$$eVL = eEL^2 = n \times 2\pi \quad ,$$

$n$  integer, is satisfied ( $\hbar = c = 1$ ), so that the length of the scalar wave pulse would be  $L = \sqrt{n2\pi/eE}$ . For an electric field having a magnitude of order  $E \sim 10^4$  kV/m (a voltage of  $10^4$  kV over a distance of 10 cm) and for  $n = 1$  the scalar wave pulse would have a length of about one micrometer.

3. What might cause the repulsive force proportional to the mass of the object?  $E = pc$  relationship does not hold for the energy transfer: rather momentum is much larger than this would allow. Thus an absorption of massless quanta is certainly not in question. Rather, the relationship suggests an ordinary non-relativistic dispersion relation between kinetic energy and momentum for a massive particle. The total mass of these particles is from numbers  $\Delta E = 10^{-4}$  J and  $\Delta p = 10^{-3}$  kgm/s equals to about 50 grams. The actual mass mentioned in the example was 18.5 grams. This makes perfect sense since only order of magnitude estimate is in question.
4. Many-sheeted space-time suggests a different explanation for the effect consistent with  $E = cp$  relationship. The effect would be actually a special case of anomalies which are very abundant and explained by the many-sheeted space-time concept.
  - (a) The space-time sheet of the pulse would act as a temporary bridge between two space-time sheets, say an atomic space-time sheet of the test object and a super-conducting magnetic flux tube of the Earth's magnetic field. Some particles from the atomic space-time sheets of the test object leak along this bridge to a larger space-time sheet or vice

versa. The presence of the leaking particles at the bridge would make it temporarily massive and stop the motion of ME/scalar wave pulse for a moment. Since absorption does not occur considerably this should occur only temporarily. In case of the scalar wave pulse the longitudinal electric field would define a force field and induce ionic currents of opposite sign between the space-time sheets.

- (b) If the particles leak to the direction of the emitter first, as is natural since the join along boundaries bonds are first formed to this direction, then effective repulsive force results as a recoil effect by conservation of total momentum holding in many-sheeted space-time but not for single space-time sheet anymore. Recoil momentum is indeed non-vanishing since the zero point kinetic energy of particles at atomic space-time sheets is non-vanishing and is transformed to the kinetic energy of the particles at the larger space-time sheet. An order of magnitude estimate is obtained by assuming that the 'dropping' particles are electrons, and that the zero point kinetic energy is  $E = \pi^2/2m_e L^2 \simeq 1$  keV resulting, when the size  $L$  of the atomic space-time sheet is one Angstrom. This gives for the fraction  $\epsilon$  of electrons in the pendulum transferred to the beam space-time sheet the estimate  $\epsilon \simeq 1.8 \times 10^{-10}$ .
- (c) If the probability for leakage is same for all particles independent of the material, the recoil momentum of the object resulting from the leakage of particle to another space-time sheet is proportional to the mass of the object as observed.

A possible test for this effect is following one. The object should lose some mass via the leakage, at least temporarily. The loss of mass is predicted to be small, a fraction of order  $10^{-13}$  about the mass of the pendulum. One could also look whether the pendulum becomes charged in the process. The leakage of the super-conducting ions from the magnetic flux tubes of say Earth to the atomic space-time sheets is a fundamental mechanism of breaking of super-conductivity in TGD universe. The quantum theory of bio-systems relies on this mechanism as well as TGD based explanations for certain free energy phenomena like Brown gas [K34] ). The 'miraculous' appearance of ions or atoms to system originally not containing them by supra current leakage from magnetic flux tube space-time sheets (say) is the basic testable prediction.

## 5.4 Does the model explain the basic observations of Tesla?

The basic vision of Tesla was that the sharp pulses involve physics not understood in the framework of Maxwell's theory. Tesla ended up with this vision on basis of certain empirical findings and it is interesting to find whether these observations could be understood in the proposed conceptual framework. In other words, could time reversal and the breaking of the second law below the p-adic time scales explain these findings.

### 5.4.1 Switching the current on as a time reversal for switching the current off

The basic observation of Tesla was that a sudden switching on of the current circuit produced strange phenomena. Besides sparks and light arcs strong charges were induced in the metal objects in environment. Physiological effects like electric shocks, pressure, sensations of heat, etc.. appeared. Also energy seemed to be liberated. The effects propagated through Faraday cage.

This kind of findings inspired Tesla to develop a technics to produce series of sharp pulses. In the system developed by Tesla, a magnet was repeatedly posed between the capacitor plates between which current was flowing to turn off the current for a moment. The outcome was a fast method for producing sharp current pulses. Tesla developed devices utilizing sharp pulses such as bi-filar coils and transformers, which produced much higher voltage in the secondary coil than one might have expected on basis of Maxwell's theory. The second end of the secondary coil was in freely in air and no current was observed at the end of the coil.

What was the source of these effects? The chapter "Rosetta Stone" in the book of Vassilatatos [H56] contains a statement which gives a hint: when the current was switched on, the current carriers behaved as if they had collided with a wall and stopped for a moment. This sounds



paradoxical since it is what one might expect to happen when the current is switched off so that resistance suddenly increases. Now just the opposite happened.

A possible solution to the paradox is provided by the reversal of geometric time. If the switching on of the current is time reversal of the switching off, the initial situation could be that the system is in a state resulting after closing off of the circuit and it might contain very high charge densities. The resulting high electric fields could even induce the evaporation of the wire. This would mean that the second law of thermodynamics would enter the game and the process would not proceed in the desired manner. In fact, it is not necessary to assume even this as following argument demonstrates.

Time reversal allows to understand what happens in the case that the time reversed process proceeds.

1. When the current is switched off, charge carriers decelerate and emit their energy as positive energy photons. When the current is switched on, charges accelerate and get their energy by emitting negative energy photons. If the system starts from a situation in which charges have "collided with a wall" the amount of energy needed is especially high. This is however not necessary.
2. Condensed matter like water or biological matter are full of population inverted many-sheeted lasers. At certain resonance frequencies corresponding to the differences of the zero point kinetic energies negative energy photons induce phase transitions discharging the population inversion of the many-sheeted laser. From certain space-time sheets charged "drop" to large space-time sheets, say magnetic flux tubes. A cascade of positive energy photons is liberated and manifests itself as "free energy".
3. The metallic (for instance) objects receiving negative energy photons lose net charge to the large space-time sheets and generate a net charge of opposite sign so that a high voltage with respect to the environment is generated. This indeed was found by Tesla to occur, and the charge definitely did not originate from the circuit generating the effect. This in fact led Tesla to postulate that ether carrying the charges was emitted in the process. Process can occur in a wide region since negative energy photons of sufficiently high energy do not respect Faraday cage. The reason is that there is not system able to absorb them and thus drop to a lower energy state. The net charge is developed because the negative energy topological light rays act as "bridges" along which the charge can move between space-time sheets. Since there is an electric field in the direction of the bridges, the charges move only in second direction fixed by the sign of the charge.
4. Switching on of the current acts as a control process which switches much larger process in environment using negative energy photons. Basically the process is due to the inherent instability of the many-sheeted space-time. What happens is analogous to a transition from a bottom of potential well in a fractal spin glass energy landscape to a bottom of a deeper potential well. The process leads to a gradual transfer of matter to larger space-time sheets and cooling. The generation of larger space-time sheets means evolution of consciousness since the p-adic prime characterizing the space-time sheets identifiable as a kind of intelligence quotient grows in the process.
5. In order to maximize the intensity of negative energy photons and get as dramatic effect as possible, the parameters characterizing the pulse series can be optimized. The basic idea is that the system is rapidly shaken. This generates accelerations of opposite sign and the system is decelerated and accelerated in a fast tempo. There is however a limitation coming from the fact that charge carriers must have enough time to return to rest. We use instinctively this trick when we try to wake up a person who has lost consciousness.

#### 5.4.2 Do scalar wave pulses appear also outside electric circuits?

The transients at the ends of voltage pulses correspond to a constant electric field propagating as scalar wave pulses with light velocity when the inertial quantum effects caused by the coupling with matter can be neglected. TGD allows solutions of field equations describing free scalar wave pulses with longitudinal electric field. Both positive and negative energy pulses are possible. The

interesting question is whether the findings of Tesla necessitate the emission of free scalar wave pulses.

1. On basis of foregoing considerations it would seem that Tesla's scalar wave pulses outside the pulsed circuits are not necessary if one wants to understand the findings of Tesla. Of course, they could be involved.
2. In the chapter "Rosetta Stone" of the book of Vassilatou [H56] there is a summary of the properties of the electro-radiative event (ERE) observed by Tesla. It seems that one could understand them as effects induced by the emission of negative energy photons.

In particular, ERE leaves wires and other circuit elements in a direction orthogonal to them. This favors strongly the interpretation in terms of topological light rays identifiable as TGD counterparts of ordinary radiation. In TGD topological light rays are however carriers of light like vacuum(!) 4-currents so that they generate coherent photons and can also carry Bose-Einstein condensates of parallel photons. The filament like light emitting structures orthogonal to metal coils could thus correspond to topological light rays. If they carry negative energy they should also generate coherent photons with negative energies.

3. Scalar wave pulses should leave an open wire in a direction parallel to the wire. The open secondary coil of Tesla transformer is a good candidate in this respect. From a capacitor the pulses should leave in a direction orthogonal to the capacitor plate and might reduce the voltage of the capacitor by carrying quanta of electric flux which are very much like small capacitors themselves moving with a light velocity.

### 5.4.3 Why the radiation observed by Tesla was so difficult to detect using photography?

In the chapter "Rosetta Stone" of his book [H56] Vassilatou tells that although the radiation emitted by the Tesla's circuits was perceived both visually and experienced as physiological effects it was very difficult to detect it instrumentally, for instance by photographing: long deposit times were required.

The explanation for this might be very simple. Body and especially retina are full of population inverted many-sheeted lasers which can amplify a weak signal of negative energy photons to a much stronger signal consisting of positive energy photons. Ordinary photographic film very probably is not able to do this.

This idea is supported also by the TGD based model for sensory receptors [K29]. In TGD Universe sensory organs are the carriers of primary qualia like color, and one can say that brain only writes the sensory music to notes. Since brain processes the sensory input in a selective manner, a back projection from brain to sensory organs making virtual sensory experiences possible must be present. Negative energy photons provide the most elegant manner to realize this mechanism since bio-matter is transparent to them unless there are many-sheeted lasers tuned to the wavelength in question.

Photo receptors indeed contain a lot of mitochondria serving as energy plants of the cell and mitochondria are known to generate visible light which is not a mere side product of metabolism [I18]. This suggests that the signal consisting of negative energy photons is amplified to a positive energy visual signal in retina. This would occur during dreaming and explain rapid eye movements. The mechanism would make it possible to see using negative energy photons and even seeing even through physical objects using phase conjugated photons as the findings of Feinberg demonstrate [D35]. A camera using negative energy photons is a possible technological application. The camera would make it possible to take images through walls.

### 5.4.4 How Tesla transformer manages to yield so high voltage amplification?

Tesla reported that his transformers have an anomalously high voltage amplification. There are two cases to be considered corresponding to pulsed ordinary and bi-filar primary coils. In both cases it might be possible to understand Tesla's findings.

1. In the case of the ordinary coil the repeated acceleration of charges induced by electric pulses generates magnetic pulses inducing in turn voltage over the secondary coil. This is what also Maxwell's theory predicts. The emission of negative energy photons inducing the increase of conductivity and an anomalous amplification of the primary current would however mean that also the voltage induced in the secondary coil is anomalously high.
2. Only the net current flowing in the pulsed bi-filar coil induces electromotive force in the secondary coil. Thus the magnetic pulses should become much sharper than in the case of the ordinary coil. Already this implies that the induced voltage along the secondary coil, being proportional to the time derivative of the magnetic flux, is very high during the short pulse. The currents induced by the electric pulse in the bi-filar coil increase also rapidly the resonance mechanism and eventually more or less compensate each other. The increase of conductivity is a further amplification mechanism possibly involved. By using a several primary bi-filar coils arranged around circle and having suitable phase lag, one could perhaps arrange a permanent anomalously large inductive effect.

#### 5.4.5 Why no current was observed in the secondaries of Tesla transformers?

Tesla did not detect the emission of charge carriers from the open ends of the secondary coils of his transformers. What one would expect is that the voltage along the secondary generates a flow of charge carriers which are stuck to the open end and that part of them leaks out. Two factors are involved.

1. There was no current at atomic dissipative space-time sheets if the charge carriers are dropped to larger space-time sheets: perhaps at the flux tubes of the magnetic fields generated in the process or at the magnetic flux tubes of the Earth's magnetic field or its dark counterpart [K22]. An interesting possibility is that closed magnetic super conducting circuits involving primary and secondary coils are formed. The magnetic flux tubes could carry the charges also to environment and negative energy topological light rays might help to transfer the charge to the metallic objects in the environment.
2. Electric pulses corresponds to a Tesla scalar wave pulses so that the surface charges associated with the ends of the pulse correspond to vacuum charges and vacuum currents. Therefore no ordinary charge carriers were associated with them.

### 5.5 Super-luminal velocities, massless extremals, and quantum jumps between quantum histories

Super-luminal light velocities have been observed during the last half decade in various systems [D14]. The first evidence came from the experiments of Chiao and Steinberg [D39] and the experiment of Nimtz and collaborators [D21]. In the latter experiment Mozart Symphony #40 was transduced using microwaves with a super-luminal velocity equal to  $4.7c$ . What makes this experiment especially interesting is that it challenges the assumption about  $c$  as the maximal signal velocity and Nimtz indeed believes that signal propagation with super-luminal velocities is possible. Variants of these experiments have been later repeated using microwaves and laser light and super-luminal velocities as high as  $300c$  have been observed [D40]. Also evidence for two different tunnelling times [D10] corresponding to the lateral displacement and angular deflection of the beam has been found.

To my opinion, these strange effects are a genuine challenge for the theories having Lorentz invariance as a basic symmetry. In TGD framework super-luminality has a surprisingly simple phenomenological description in terms of quantum jump between quantum histories concept and massless extremals (MEs) providing a 'Bohr orbit' model for the quantized gauge fields. These concepts provide also a first principle quantum description for dissipation and self-organization [K63]. MEs are in a key role in TGD based model of consciousness and living matter [K29, K57, K60]. The strange causal anomalies of neuroscience [J14, J21] and the observations of Radin and Bierman [J10] provide support for the notion. The model for the propagation with effective

super-luminal velocity provides especially clean evidence for the importance of MEs and allows to build a more detailed view about MEs. Super-luminal effects also encourage to take seriously the exotic energy- and communication technologies suggested by TGD.

### 5.5.1 General model for super-luminal velocities

Consider first the general model for the super-luminal velocities in TGD framework.

#### Massless extremals as Bohr orbit representation of em field

In TGD framework self-organization occurs by quantum jumps between quantum histories. Quantum histories have as their geometric correlates classical space-time surfaces with topological field quanta represented by space-time sheets and carrying classical gauge field configurations providing 'Bohr orbit' type representation for quantum fields. The 'Bohr orbits' associated with photons correspond to the so called massless extremals (MEs) carrying superposition of the harmonics  $f_n = n f_1$  of the fundamental frequency  $f_1$  determined by the length  $L$  of ME ( $f_1 = c/L$ ). The light-like vacuum current associated with ME generates coherent photons and ME also carries a Bose-Einstein condensate of collinear photons at these frequencies. Assuming that these photons are detected, a nice understanding of the relationship between descriptions based on classical fields and photons results. What is important is that both aspects are necessary for the proper understanding of the phenomena involved.

#### The interaction of the space-time surface representing photon beam with medium breaks it into MEs

The effect involves the interaction of the photon beam with the medium idealized as a potential barrier and by a model for the dispersion boiling down to a frequency dependent di-electric constant and magnetic permeability. This interaction involves dissipation which means in TGD framework self-organization involving a sequence of quantum jumps between quantum histories. The intuitive view is that coherence is lost so that individual components of the classical em field propagate without interfering. Geometrically this means that medium induces the decomposition of the classical em field represented by single space-time sheet  $X_e^4$  associated with photon beam state to separate space-time sheets represented as MEs which are analogous to virtual photons. One can visualize the effect of the medium to the space-time surface representing the em field as a collision inducing the breaking of this surface into pieces represented by MEs analogous to virtual photons.

#### The drift of ME towards geometric past induces the increase of the effective light velocity

The classical 4-dimensional(!) field configuration associated with ME changes in each quantum jump. Depending on whether the average shift occurring in the quantum jump is forwards or backwards in time, a reduction or increase of the effective light velocity results. If MEs correspond to space-time sheets of finite geometrotemporal duration (which is not same as the duration defined by the number of quantum jumps during which ME exists), this shift of the field configuration could simply result from the drift of ME to the direction of the geometric future or past. Super-luminality would mean that the direction of the arrow of the geometric time changes locally.

The reversed time arrow means that MEs carrying negative classical energies are generated in the experiment. The negative energy MEs would drift to the direction of the geometric past and give rise to effective super-luminality whereas positive energy MEs would drift to the direction of the geometric future and induce the effective reduction of the light velocity observed in the normal situation. Only effective sub-/super-luminality is in question since light velocity is  $c$  for each ME in the sequence. In TGD inspired theory of consciousness this mechanism is fundamental for the understanding of EEG: the velocity  $v \sim 10$  m/s identified usually as phase velocity of EEG waves correspond to the drift velocity of ELF MEs in TGD framework [K57].

Rather paradoxically, it is possible to have a situation in which after sufficiently many quantum jumps the classical field leaves the medium before it entered it in the space-time surface associated with the first quantum jump. Note however that for the space-time surface associated with the last quantum jump classical signal entered the medium before it left it.

Doppler shift provides a test distinguishing between genuine super-luminality and effective super-luminality and perhaps also between TGD view and standard dispersion model based on the assumption that propagation velocity in medium depends on frequency. The prediction is that  $c$  rather than  $v > c$  should appear in the formula of the Doppler shift.

### Interference of photon beams described in terms of MEs

The basic question is how should one describe in TGD framework the combination of beams to form single beam giving rise to interference effects? To answer this question one must keep in mind the basic philosophy: it is classical gauge fields associated with MEs which provide the fundamental description of the phenomenon and photons provide only a diagnostic tool allowing to measure the strengths of the classical fields associated with MEs.

The fusion of photon beams is the reverse of the process causing de-coherence and thus describable as a fusion of MEs to the space-time sheet  $X_e^4$  representing the em field outside medium. Positive/negative energy ME is a geometrical analog of a virtual particle emitted by  $X_e^4$  and travelling forwards/backwards in time to be eventually absorbed.

The fusion of photon beams is the reverse of the process causing de-coherence and thus describable as a fusion of MEs to the space-time sheet  $X_e^4$  representing the em field outside medium. Positive/negative energy ME is a geometrical analog of a virtual particle emitted by  $X_e^4$  and travelling forwards/backwards in time to be eventually absorbed.

Concerning the precise geometric meaning of the fusion there one can consider two options:

1. Fusion corresponds to the formation of topological sum in which case ME and  $X_e^4$  are parallel space-time sheets having distance of order  $CP_2$  size. The interference of the classical gauge fields is not possible in this case since they reside on different space-time sheets.
2. Fusion corresponds to the formation of join along boundaries bonds between boundaries of ME and  $X_e^4$ . The classical fields associated with ME interfere with those associated with  $X_e^4$  when they enter into  $X_e^4$ . Hence this option is strongly favored.

In case 2) the resulting structure is a 4-dimensional variant of a typical string diagram with each ME representing a loop carrying photons with basic frequency and its harmonics. These loops also interact with the medium and interaction is also induced by the formation of join along boundaries bonds. In each quantum jump the positive/negative energy virtual ME shifts forwards/backwards in geometric time: this is very much like motion of MEs along the 3-dimensional boundary of  $X_e^4$ . In normal dispersive media positive energy MEs leading to the reduction of the light velocity dominate.

This rather surreal picture suggests that virtual MEs are like living creatures creeping along the boundary of  $X_e^4$  to the direction of past or future: this brings in mind proteins creeping in a similar manner along microtubular surface. In fact, MEs are identified as carriers of life forms in TGD inspired theory of living systems [K29]: the reason is that they carry so called exotic p-adic Super Virasoro representations providing MEs with enormous information storage and representation capacities.

### Do the photons associated with negative energy MEs have positive or negative energies?

Classical-quantum correspondence suggests strongly that the photons generated by the negative energy MEs have negative energies. It is quite possible that negative energy photons could be regarded as counterparts of negative energy on mass shell photons appearing in the Hamiltonian formalism and assigned with annihilation operators. On space-time sheets with negative time orientation they do not annihilate vacuum and generate genuine many particle states. These on mass shell states have however finite spatiotemporal extend. When the plane wave restricted to a finite space-time volume is developed into Fourier series in entire Minkowski space, the series contains also off mass shell components: this suggests an obvious connection with the virtual particle concept used in Feynman diagrammatics.

If negative energy photons are generated, the absorption of these photons on the positive energy space-time sheets could result as transitions of the excited states of atoms to ground state without

photon emission and would be analogous to higher order processes induced by the exchange of negative energy virtual photons. In the similar manner emission of negative energy photons would lead from ground state to an excited state. The creation of pairs MEs with opposite time orientations, and thus also classical energies, accompanied by positive/negative energy photons provides mechanisms of amplification and population inversion. Population inversion can occur through the emission of negative energy photons whereas as amplification involves emission of positive energy photons in a state with an inverted population. Amplification/generation of population inversion presumably involves BE condensation of positive/negative energy photons on positive/negative energy MEs and a generation of positive/negative energy BE condensate.

Since the transmission time is measured by interference effects, it is basically classical field which is measured by the rate of photons it produces. More concretely and using standard terminology, the incoming photon beam is split to a part going through the optical barrier and a part which travels in the free space, and these beams are combined together in such a position that destructive or constructive interference occurs [D14]. Hence the experimental arrangements used do not provide answer to the question whether negative energy photons are present or not.

Rather interestingly, the experimental arrangement yielding super-luminal velocity of  $300c$  [D40] is a slight modification of an arrangement yielding amplification. In a normal situation first beam generates population inversion and second beam with a precisely defined wavelength is amplified. In the super-luminal situation the wavelength of the second beam differs slightly from the value yielding amplification and only super-luminality results.

The following interpretation of the results might make sense.

1. In the situation giving rise to amplification the transitions to ground state generate photons which suffer Bose-Einstein condensation to the ME representing second beam.
2. In the super-luminal situation population reversal seems to be amplified by a mechanism generating Bose-Einstein condensate of negative energy photons emitted in the transitions from the ground state to the excited state.
3. A recoil effect, which is slightly different for the atomic transition and its reversal due to the different rest masses of the atom in the ground state and excited states, explains why the super-luminality occurs for a slightly different photon wavelength than amplification. The rest mass of the atom is given by  $Mc^2 - E_i$ , where  $E_i$ ,  $i = 1, 2$  is the binding energy of atom in ground state and excited state. A little calculation using energy and momentum conservation for the emission of positive/negative energy photon shows that the fractional difference of photon wavelengths is in a good approximation

$$\frac{\Delta\lambda}{\lambda} = -\frac{\Delta E}{E} = \frac{1}{2}\left(\frac{E}{Mc^2}\right)^2. \quad (5.5.1)$$

If this interpretation is correct, then the only conclusion seems to be that beam amplification represents a laboratory realization of the TGD based exotic mechanism of energy production.

### 5.5.2 Quantitative model

In the following the hypothesis that super-luminality is associated with a tunnelling through an optical barrier [D14] is criticized, a very brief summary of the basic tunnelling time models is given, and TGD based model of super-luminality based on the hypothesis that self-organization is involved.

#### Is super-luminality really associated with optical tunnelling?

In standard quantum mechanics the transmission of photons in the experimental situations involving super-luminality is modelled as a tunnelling through optical barrier and tunnelling time is in the role of the basic parameter. This approach is however plagued by several difficulties basically due to the highly phenomenological description of the dissipative effects.

1. Dispersive medium allows a handful of different velocities corresponding to phase -, group -, energy-, signal- and front velocities. The problem is to decide which of these velocities, if any, corresponds to the velocity of photon. In TGD framework this problem does not appear since the description relies solely on the classical fields associated with MEs.
2. The treatment of the situation as tunnelling can be questioned if self-organization is involved since tunnelling is essentially an effect associated with single solution of Schrödinger equation. In TGD approach the phenomenon is not treated as tunnelling but as self-organization phenomenon.

Depending on the identification of the velocity of photon, several theories for the tunnelling time result [D15] .

1. In Wigner’s theory [D15] group velocity is identified as the photon velocity and several experiments support the view that effective group velocity determines the transmission time [D14] . What one calculates is the time for the peak of a wave packet to emerge from the exit face of the tunnel barrier relative to the time the peak of the induced wave packet arrives at the entrance face. TGD view is consistent with this identification as long as one can assume that the phenomenological description of self-organization by quantum jumps using classical field equations with complex dielectric constant is a good approximation.
2. Buttiker-Landauer time is based on semiclassical model [D15] . Since the phenomenon is modelled as a tunnelling phenomenon, wave vector and velocity are purely imaginary inside the medium so that one must use absolute value. To my opinion, this feature makes this approach highly questionable although it seems obvious to me that the emergence of the imaginary time signals for the presence of two times: the geometric time and the subjectively experienced time defined by the sequence of quantum jumps in TGD.

**Model for the drift of ME in time direction**

Consider now a simple TGD based model for the reduction/increase of the effective light velocity and estimation of the effective light velocity.

1. In single quantum jump the average increase of psychological time defined as the center of mass temporal coordinate for the cognitive space-time sheet representing conscious observer is assumed to be given by

$$\tau = \tau_{CP_2} \simeq 10^{-39} \text{ sec} .$$

The phrase ‘cognitive space-time sheet’ sounds strange in present context but means only that space-time sheet has finite geometro-temporal duration. This hypothesis applies to quantum jumps of any self-organizing system in particular MEs, which are basic building blocks of living matter in TGD inspired theory of consciousness. The estimate for  $\tau$  relies on dimensional analysis and is assumed to hold true for space-time sheets which have suffered topological condensation to the interior of a larger space-time sheet by topological sum contacts. This however is not the case now since MEs suffer 3-dimensional topological condensation on the boundary of  $X_e^4$  representing em field outside the medium (the formation of join along boundaries bonds is nothing but topological condensation for boundaries).

2. If ME is glued by join along boundaries bonds to the boundary of  $X_e^4$ , the average increment of geometric time in quantum jump, call it  $\tau_B$ , is not necessarily equal  $\tau$  and one has

$$\tau_B = p\tau . \tag{5.5.2}$$

Here  $p$  represents a numerical factor depending on the properties of the cognitive space-time sheet and on the properties of the boundary of  $X_e^4$ . Unless  $n$  is constant, cognitive space-time sheets drift along the 3-dimensional boundary of  $X_e^4$  with different velocities. Situation

can be also complicated by the fact that ME need not be all the time in the self-organizing self-state and it could be that the drifting does not occur otherwise: this obviously implies the variation of the effective values of  $\tau_B$  and  $p$ .

Consider now how the reduction/increase of the effective light velocity results in this picture.

1. Suppose that the classical field configuration is shifted in time direction by average time interval

$$\Delta t = p\tau \quad .$$

in single quantum jump. For  $p > 0$  ( $p < 0$ ) the shift is to the direction of the geometric future (past). If ME shifts as such without any change in the field configuration and is all the time in the self-organizing state, then  $p = 1$  corresponds to the simplest situation in which all cognitive space-time sheets drift with the same velocity to the direction of future. During the self-organization process initiated at time  $t_0$  and having lasted for a time  $T = t - t_0$ , the net temporal shift of the field configuration, is

$$\Delta T = pT = p(t - t_0) \quad . \quad (5.5.3)$$

The resulting temporal shift of the field configuration  $\Psi(x, t)$  is

$$\Psi(x, t) \rightarrow \Psi(x, t - \Delta T) = \Psi(x, t - p(t - t_0)) \quad .$$

2. In particular, the effectively 2-dimensional field configuration

$$\Psi(x - ct)$$

associated with ME and propagating with light velocity, is replaced with the field configuration

$$\Psi(x - c(t - pT)) = \Psi(x - c(1 - p)t + pct_0) \quad . \quad (5.5.4)$$

The effective propagation velocity is thus

$$v = c(1 - p) \quad , \quad (5.5.5)$$

and is indeed super-luminal for  $p < 0$ . Also phase shift determined by the parameter  $pct_0$  occurs.

#### Relationship of the effective light velocity with the parameters describing dispersive media

Experimental data as well as the fact that classical fields associated with MEs provide a basic description of the process, encourage the identification of the effective light velocity  $v$  as group velocity

$$v = c_g = \frac{d\omega}{dk} \quad . \quad (5.5.6)$$

From the relationships



$$\omega(k) = kc_1 \quad , \quad c_1 = Kc \quad , \quad K = \sqrt{\frac{\epsilon_0\mu_0}{\epsilon(\omega)\mu(\omega)}} \quad , \quad (5.5.7)$$

one has

$$\begin{aligned} v &= c_1 + \omega \frac{dc_1}{d\omega} \quad , \\ 1 + p &= K + \omega \frac{dK}{d\omega} \quad . \end{aligned} \quad (5.5.8)$$

Thus one can relate the parameter  $p$  to the parameters  $\epsilon$  and  $\mu$  characterizing the dispersive medium phenomenologically.

The fact that several super-luminal velocities are observed [D14] , means that the negative energy MEs generated in the experiment drift with widely different average velocities to the geometric past. The possibility of several drift velocities could relate to the fact that the dispersion relation  $\omega = kc_1(\omega)$  allows several solutions for a given wave vector. Since also sub-luminal effective transmission velocities depend on frequency, also the positive energy MEs having different lengths and therefore different fundamental frequencies drift with different average velocities to the direction of geometric future. The appearance of several super-luminal light velocities suggests that there are several simultaneous self-organization processes and that the value of  $p$  depends on the asymptotic pattern of the self-organization process.

The observation of several super-luminal velocities is consistent with the assumption that the temporal drift rate along the boundaries of  $X_e^4$ , as opposed to the drift rate along the interior of  $X_e^4$ , is not constant and can vary by at least two orders of magnitude. An alternative possibility is that MEs spend only part of time in quantum self-organizing 'self-state' (being thus p-adically unentangled) in which they drift. The possibility of velocities as high as  $v = 300c$  [D40] would mean that for lower super-luminal velocities, say  $v = 1.8c$ , ME drifts along boundary for less than one percent of time.

### 5.5.3 Possible technological implications

The significance of the super-luminal velocities is that they provide empirical support for those predictions of quantum TGD, which are in deepest conflict with the standard physics views and predict the possibility of new, rather science fictive technologies.

1. The mere assumption that space-time is many-sheeted 4-surface, implies the possibility of negative time orientations and negative energies. This suggests the possibility of generating energy from vacuum by simply generating pairs of space-time sheets with opposite energies. For instance, the generation of MEs with opposite momenta could be in a fundamental role in biology and make possible coherent motion. MEs carry also so called exotic representations of Super Virasoro algebra giving rise to exotic ultra light particles and these particles are in a key role in TGD based model of life.
2. The possibility of classical communications backwards in time are suggested strongly and would be realized by MEs with negative time orientation. Quantum communications forwards/backwards in time would correspond to the drift of positive/negative energy MEs forwards/backwards in geometric time and the explanation of super-luminality involves this assumption. These communications are nothing but conscious life moving forwards/backwards in geometric time (perhaps one could speak of life and anti-life!). the basic difference between classical and quantum communications would be that message is replaced by a conscious messenger in quantum communications. Combination of the communications into geometric past and future would make possible apparent super-luminal communications. Incredible as it sounds, also communications with the civilizations of the geometric past and future become in principle possible.

The explanation of both the ordinary reduction of the effective propagation velocity of light and super-luminality in terms of MEs, together with the explanation of the amplification mechanism

associated with the experimental arrangement used by Wang, means that these experiments provide clear empirical evidence for the generation of MEs (as well as photons) with both negative and opposite energies having finite time duration and drifting quantum jump by quantum jump into geometric future or past. These properties are indeed crucial for the prerequisites of new energy and information technologies.

### Acknowledgements

I want to thank Dennis Bayne for turning my attention to the super-luminal light velocities and for generously providing material about the effect. I am also grateful for Ron Blue for sending the article of R. Y. Chiao about gravitational effects related to super-conductors. I am grateful for Tapio Tammi, Jari Aaltonen, Juha Hartikka, and Jukka Kinnunen for generously providing material relating to the free energy research and for providing the needed gentle pressure forcing to take free energy research seriously enough. In particular, the concrete results from the experimentation with bi-filar coils provided by Tapio Tammi have been of utmost importance for developing the model for the bi-filar coil from first rather unrealistic ideas to a model consistent with basic facts. Juha's experimental work with lifters and discussions with Juha have been of considerable help in developing detailed models for lifters and rotating magnetic systems.

## 5.6 Figures and illustrations

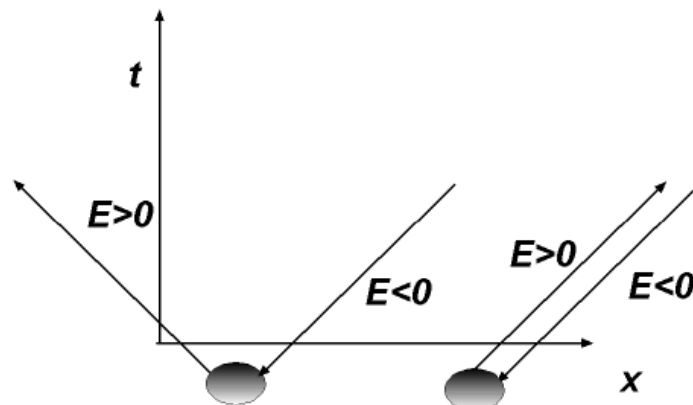

Figure 5.1: Time mirror mechanism

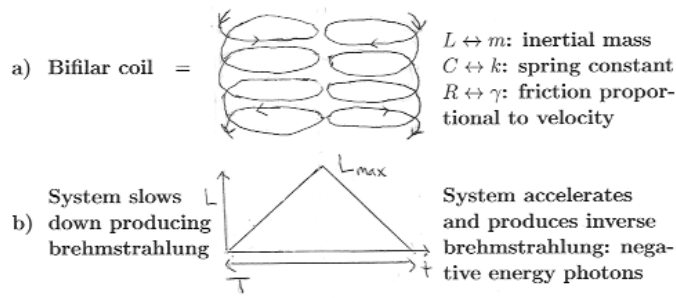

Figure 5.2: a) The structure of bi-filar coils and the mechanical analog of RCL circuit as a harmonic oscillator. b) The reduction of the mass of the harmonic oscillator at the second half of the magnetic pulse implies acceleration and generation of negative energy photons in order to get energy.

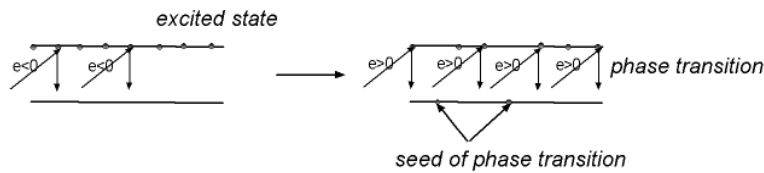

Figure 5.3: A mechanism of energy production based on negative energy topological light rays and population inversion.

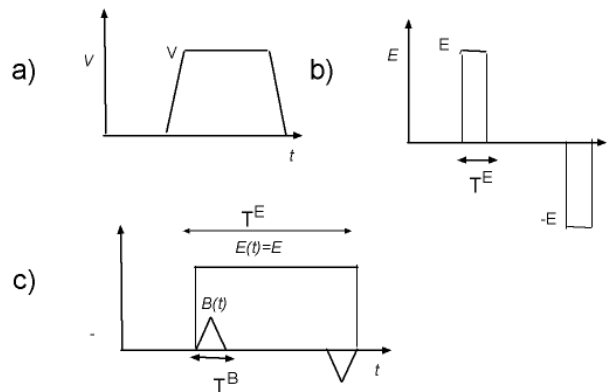

Figure 5.4: Constant voltage pulse (a) and the corresponding electric (b) and magnetic (c) pulses in the bi-filar coil.

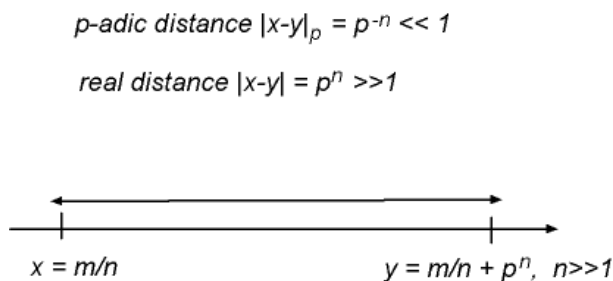

Figure 5.5: Rational valued points  $x$  and  $y = x + p^n$ , which are close to each other  $p$ -adically, are far from each other in real sense.

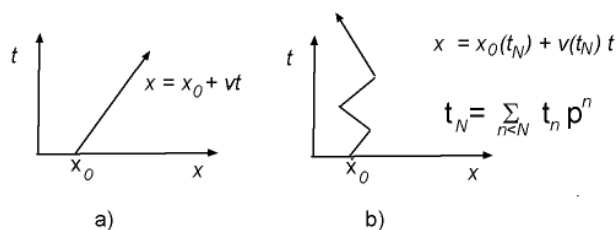

Figure 5.6: The non-determinism of  $p$ -adic differential equations in the case of a free particle. a) In real case the initial position  $x_0$  and and velocity  $v$  determine the orbit. b) In the  $p$ -adic case  $x_0$  and  $v$  are piecewise constant functions of time and the orbit resembles that associated with Brown motion.

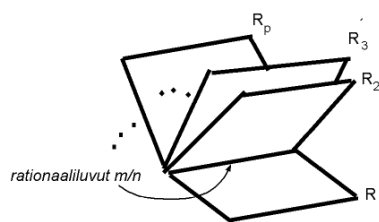

Figure 5.7: Rational numbers are common to both reals  $R$  and all  $p$ -adic number fields  $R_p$ ,  $p = 2, 3, \dots$ . These number fields can be "glued" together along the rational numbers to form a book like structure. Rational numbers correspond to the rim of the book and different number fields to its pages.



## Chapter 6

# About Concrete Realization of Remote Metabolism

### 6.1 Introduction

The idea of "remote metabolism" (or quantum credit card, as I have also called it) emerged more than a decade ago - and zero energy ontology (ZEO) provides the justification for it. The idea is that the system needing energy sends negative energy to a system able to receive the negative energy and make a transition to a lower energy state. This kind of mechanism would be ideal for biology, where rapid reactions to a changing environment are essential for survival. Originally this article was intended to summarize a more detailed model of remote metabolism but the article expanded to a considerably more detailed view about TGD inspired biology than the earlier vision.

#### 6.1.1 Short glossary about the basic concepts of TGD

The model involves several new physics elements. It is good to begin with a little glossary to get a rough view about basic ideas of TGD and TGD inspired biology. The following list explains briefly the notions relevant to the ontology of TGD Universe.

- The notion of *many-sheeted space-time* (see fig. <http://www.tgdtheory.fi/appfigures/manysheeted.jpg> or fig. 9 in the appendix of this book) distinguishes between TGD and special and general relativities. In TGD framework space-times are regarded as a 4-D surfaces in certain 8-D space  $M^4 \times CP_2$  obtained from empty Minkowski space  $M^4$  by adding four small dimensions. The study of field equations characterizing space-time surfaces as "orbits" of 3-surfaces (3-D generalization of strings) forces the conclusion that the topology of space-time is non-trivial in all length scales. Many-sheeted space-time consists of space-time sheets in various length scales with smaller sheet being glued to the larger ones by wormhole contacts (see fig. <http://www.tgdtheory.fi/appfigures/wormholecontact.jpg> or fig. 10 in the appendix of this book) identified as building bricks of elementary particles. The sizes of wormhole contacts vary but are at least about  $CP_2$  size (about  $10^4$  Planck lengths) and thus extremely small for ordinary elementary particles.
- The notion of many-sheeted space-time forces the replacement of reductionism with *fractality*. This is the basic motivation for applying TGD in, say, biology. The most radical prediction is the existence of scaled variants of physics of strong and weak interactions in various length scales, and biology is especially interesting in this respect. Fractality reflects itself as various length scale hierarchies.
  1. *p-Adic physics* as a physics of cognition and intention and the fusion of p-adic physics with real number based physics are new elements. p-Adic mass calculations lead to the *p-adic length scale hypothesis* stating that preferred p-adic length scales correspond to primes  $p$  near powers of two:  $p \simeq 2^k$ ,  $k$  positive integer. Mersenne primes  $M_k$  of form  $2^k - 1$ , and Gaussian Mersennes  $M_{k,G}$  of form  $(1+i)^k - 1$  ( $k$  some prime in both cases)

are especially favored with biologically interesting length scale range [10 nm, 2.5  $\mu\text{m}$ ] containing as many as four electron Compton scales assignable to Gaussian Mersennes, which could be seen as a number theoretic miracle.

2. **Dark matter hierarchy** realized in terms of a hierarchy of values of effective Planck constant as integers using  $\hbar$  as a unit. Large value of  $h_{eff}$  makes possible macroscopic quantum coherence crucial in living matter. For instance, it allows dark ELF photons with energies above thermal energy ( $E = h_{eff}f$ ).
- **Topological field quantization.** This distinguishes between TGD and Maxwell's electrodynamics. TGD leads to a geometrization of the notion of classical field. Both weak, electromagnetic, and gluon fields are known once the space-time surface as a solution of field equations is known. This implies an enormous reduction in the number of degrees of freedom but the many-sheeted space-time brings in additional degrees of freedom allowing to avoid conflicts with known experimental facts about fields.

Topological field quantization means that fields are replaced by quanta of space-time. For instance, constant magnetic field decomposes into space-time surfaces of finite size representing flux tubes or sheets. Field configurations are like Bohr orbits carrying very specific "archetypal" field patterns. Radiation fields corresponds to so called topological light rays or massless extremals (MEs), magnetic fields correspond to magnetic flux quanta (flux tubes and sheets) having as primordial representatives "cosmic strings", electric fields correspond to electric flux quanta (say cell membrane), and elementary particles have so called  $CP_2$  type vacuum extremals as basic building bricks.

- **Field body and magnetic body.** These notions follow from topological field quantization. In TGD Universe a physical system has a corresponding field identity - field body or magnetic body - in the sense that a given topological field quantum corresponds to a particular source (or several of them - say in the case of flux tube connecting two systems). In Maxwell's electrodynamics one cannot achieve this kind of identification since the fields created by different sources superpose. Superposition is replaced with a set theoretic union implying that only the *effects* of the fields assignable to different sources on test particle superpose.

Field body and magnetic body bring in new degrees of freedom highly relevant in TGD inspired quantum biology. Magnetic body has hierarchical onion-like structure reflecting corresponding structure for the system with which it is associated. One can also speak of **dark magnetic body** corresponding to the value of effective Planck constant  $h_{eff}/h = n$ . Dark space-time surface can be regarded as an analog of  $n$ -sheeted Riemann surface - an  $n$ -furcation of space-time surface occurring because of the extremely non-linear dynamics of Kähler action.

- **Magnetic body as an intentional agent using biological body as a sensory receptor and motor instrument** is an attractive identification but one should be cautious. One could argue that magnetic body and biological body together form the natural intentional unit - kind of "super-body" - and that in remote metabolism energy is transferred between biological and magnetic body parts. Note however that personal magnetic body has a hierarchical onion-like layered structure and that several magnetic bodies can use the same biological body making possible remote mental interactions such as hypnosis [L7].
- **Magnetic flux tubes and sheets** serve as "body parts" of the magnetic body, and one can speak about magnetic motor actions. Besides concrete motion of flux quanta analogous to ordinary motor activity, basic motor actions include the contraction of magnetic flux tubes by a phase transition reducing Planck constant, and the change in thickness of the magnetic flux tube changing the value of magnetic field and thus the cyclotron frequency. Reconnections of the flux tubes allow to magnetic bodies to get in contact and temporal variations of magnetic fields inducing motor actions of magnetic bodies favor the formation of reconnections. Flux tube connections at molecular level bring a completely new element to biochemistry. Flux tube connection serves as a space-time correlate for attention in TGD inspire theory of consciousness. ATP-ADP process could have interpretation in terms of reconnection.

- **Cyclotron Bose-Einstein condensates** of various charged particles can accompany magnetic bodies. Cyclotron energy  $E_c = hZeB/m$  is much below thermal energy at physiological temperatures and magnetic fields possible in living matter. In the transition  $h \rightarrow h_{eff}$   $E_c$  is scaled up by a factor  $h_{eff}/h = n$  and for sufficiently high value of  $h_{eff}$  cyclotron energy can be above thermal energy  $E = h_{eff}ZeB/m$ . The observations of Blackman about quantum like effects of radiation at harmonic of  $Ca^{++}$  cyclotron frequency could be used as motivation for introducing the hierarchy of Planck constants. The proposal is that cyclotron Bose-Einstein condensates associated with DNA and cell membrane - perhaps cell membrane proteins - play a key role in biology.
- **Massless extremals (MEs)/topological light rays** are extremals of the Kähler action replacing radiation fields in Maxwell's theory. Laser beam serves as a good analogy for ME. MEs are tubular space-time surfaces carrying classical fields propagating with light velocity. Since the waves propagate in single direction only there is no dispersion and MEs make possible precisely targeted communications without loss of information. Linear superposition is possible in the direction of ME. Both electromagnetic, weak, color and gravitational fields are present as induced fields. MEs can carry light-like currents and can be charged: in Maxwell's theory this is not possible. For charged MEs polarization has a longitudinal component. Tesla's scalar waves are obvious analogs for charged MEs. Charged MEs can however serve as correlates also for charged particles like electron.
- **Josephson junctions** are junctions between two super-conductors, say, parallel wires or analogs of capacitor plates carrying supra currents. **Josephson current** is generated when there is a phase difference  $\Delta\Phi(t) = \int ZeVdt/h$  between the two super-conductors involved. Josephson current is of the form  $J = J_0 \sin(\Delta\Phi(t))$ . For constant voltage  $V$  the current is oscillating with **Josephson frequency**  $f_J = ZeV/h$ . The frequency for cell membrane is rather high for the ordinary value of Planck constant but  $h \rightarrow h_{eff}$  scales it down so that even ELF frequencies are possible. The charge carriers of Josephson current are in accelerated motion and expected to radiate. The radiation is quantum process analogous to emission of photon by an atom and occurs with quantized energies coming as harmonics of Josephson energy  $ZeV$  having interpretation as electrostatic energy gained by the charge carrier "freely falling" through the junction. Charged particle can jump to the other side of cell membrane by absorbing positive energy Josephson photon or sending negative energy Josephson photon. This would define the basic mechanism of charge transfer for ionic pumps.

In TGD inspired biology Josephson junctions are associated with electric flux quanta of which cell membrane carrying extremely strong electric field represents the basic example. In low length scale resolution one can regard the entire cell membrane as a Josephson junction. In improved length scale resolution cell membrane proteins are natural candidates for Josephson junctions and might define quantum counterparts for channels and pumps. The conjecture is that superconductors and Josephson junctions form a length scale hierarchy. The levels of this hierarchy can communicate by exchange of Josephson photons if the values of  $h_{eff}$  and Josephson energies were the same for them.

- The recent view about **negentropic entanglement** forced by Negentropy Maximization Principle (NMP) [K44] is very simple and leads to a connection between negentropic entanglement (see fig. <http://www.tgdtheory.fi/appfigures/cat.jpg> or fig. 21 in the appendix of this book), dark matter hierarchy, p-adic physics, and quantum criticality. NMP holds true only in the intersection of realities and p-adicities - that is, applies in the situations in which density matrix for a system and its complement is multiple of identity matrix resulting in general quantum measurement identified as a measurement of the density matrix. Negentropic entanglement is always maximal entanglement so that the density matrix is proportional to unit matrix and corresponds to a value of effective Planck constant equal to the integer  $\hbar_{eff} = n\hbar$  telling the number of the entangled states. The p-adic prime assignable to the system corresponds to the largest prime power factor of  $n$ .  $n$  has interpretation as the number of sheets of multi-sheeted covering defining  $n$ -furcation of space-time sheet and the  $n$ -furcation is manifestation of quantum criticality implying  $n$ -sheeted covering property. Negentropic entanglement is a prerequisite for an experience defining abstraction as a rule having as instances the state pairs appearing in the entangled state. Note that the state



pairs are not unique since any unitary transformation acting in the same manner to the two entangled state basis is allowed.

- In *zero energy ontology* (ZEO) physical states are pairs of positive and negative energy parts having opposite net quantum numbers and identifiable as counterparts of initial and final states of physical event in ordinary positive energy ontology. Positive and negative energy parts of the zero energy state are at the opposite boundaries of *causal diamond* (CD) defined as a double-pyramid-like intersection of future and past directed light-cones of Minkowski space.

There is a fractal hierarchy of CDs within CDs (and perhaps also overlapping with each other). The sizes of CDs (definable by the temporal distance between its tips) come as integer multiples of  $CP_2$  time  $T_{CP_2}$  and the fundamental time scale  $T = .1$  s of biology corresponds to  $T = nT_{CP_2}$ ,  $n = M_{127} = 2^{127} - 1$ . This time scale corresponds to the secondary p-adic time scale assignable to electron and is macroscopic. As a matter of fact, all elementary particles correspond to macroscopic time scales: this predicts a direct connection between elementary particle physics and macroscopic physics.

In TGD inspired theory of consciousness CD defines what might be called a spot-light of consciousness in the sense that the contents of conscious experiences associated with given CD are about the space-time sheets in the imbedding space region spanned by CD. Physical states are superpositions of pairs of positive and negative energy parts at opposite boundaries of causal diamond (CD) defined as double-pyramid-like intersection of future and past directed light-cones of Minkowski space. The conserved quantum numbers of positive and negative energy parts are opposite. Zero energy state is actually a superposition of zero energy states associated with CDs of different size scale characterized by integer. Time evolution with respect to subjective time is a sequence of state function reductions at opposite boundaries of CDs involving localization of that boundary and state function reduction at it but necessarily forcing the de-localization of the opposite boundary. During this process CDs in the superposition tend to increase in size, and this gives rise to the experienced flow and arrow of time. The pairs of state reductions at opposite boundaries correspond to sensory percept followed by motor action as reaction at the level of the brain. Phase conjugate laser beam would represent a standard example of negative energy photons.

Negative energy signals would have several functions: realization of intentional action initiating neural activity in geometric past would explain Libet's well-known findings, memory as communication with geometric past with time reflection in time direction defining "seeing" in time direction, and remote metabolism.

### 6.1.2 Plan of the chapter

The model of remote metabolism and the vision behind it is applied to biology. It is shown that the basic notions of the theory of Ling about cell metabolism inspired by various anomalies have natural counterparts in TGD based model relying on the notion of magnetic body. Remote metabolism can be considered as a universal mechanism of metabolism with magnetic body of ATP, or system containing it, carrying the metabolic energy required by the biological user. In particular, the role of ATP is discussed in Ling's theory and from the point of view of TGD-inspired theory of consciousness.

It is easy to imagine new technologies relying on negative energy signals propagating to the geometric past and ZEO justifies these speculations. Remote metabolism could make possible a new kind of energy technology. The discoveries of Tesla made more than a century ago plus various free energy anomalies provide excellent material for developing these ideas, and one ends up with a concrete proposal for how dark photons and dark matter could be produced in capacitor-like systems analogous to cell membranes and acting as Josephson junctions and how energy could be extracted from "large" magnetic bodies.

The model identifies Josephson frequency with the subharmonic of the frequency characterizing the periodicity of a periodic voltage perturbation assumed to correspond to cyclotron frequency in biological applications. Together with quantization conditions for charge and effective Planck

constant it leads to precise quantitative predictions for capacitor-like systems acting as dark capacitors. Also a relationship between the magnetic field at magnetic body of the system and the voltage of the capacitor-like Josephson junction emerges.

The predictions allow new quantitative insights about biological evolution as emergence of Josephson junctions realized as capacitor-like systems both at the level of cell, DNA and proteins, and brain.  $h_{eff}$  can be related to Josephson frequency and cyclotron frequency and thus to measurable parameters.  $h_{eff}$  serves as a kind of intelligence quotient and its maximization requires the maximization of both the voltage and area of the membrane-like capacitor system involved. This is what has happened during evolution. Indeed, the internal cell membranes, cortical layers and DNA double strand in chromosomes are strongly folded, and the value of membrane electric field is roughly twice the value of the electric field for which di-electric breakdown occurs in air. Even 40 Hz thalamocortical resonance frequency can be understood in the framework of the model.

The claimed properties of Tesla's "cold electricity" suggest interpretation in terms of dark matter in TGD sense. This leads to a proposal that a transition to dark phase occurs when the value of voltage equals the rest mass of charged particle involved. This criterion is generalized to the case of cell membrane and relates the values of  $h_{eff}$ , p-adic prime  $p$ , and threshold potential for various charged particles to each other. The idea that nerve pulse corresponds to the breakdown of super-conductivity as a transition from dark to ordinary phase receives additional support. The resulting picture conforms surprisingly well with the earlier speculations involving dark matter and p-adically scaled variants of weak and color interactions in biologically relevant length scales. An extremely simple mechanism producing ATP involving only the kicking of two protonic Cooper pairs through the cell membrane by Josephson photon as a basic step is proposed. Also the proposal that neutrino Cooper pairs making sense in TGD framework but not in standard model could be highly relevant not only for cognition but also metabolism finds support.

The appendix of the book gives a summary about basic concepts of TGD with illustrations. There are concept maps about topics related to the contents of the chapter prepared using CMAP realized as html files. Links to all CMAP files can be found at <http://www.tgdtheory.fi/cmaphtml.html> [L8]. Pdf representation of same files serving as a kind of glossary can be found at <http://www.tgdtheory.fi/tgdglossary.pdf> [L9]. The topics relevant to this chapter are given by the following list.

- Magnetic body [L19]
- Basic Mechanisms associated with magnetic body
- Bio-anomalies [L12] [L11]
- Pollack's observations [L22]
- Biophotons [L13]
- Cell membrane anomalies [L14]
- Pollack's observations [L21]
- Quantum antenna hypothesis [L23]
- Quantum gravity and biology [L24]
- Quantum metabolism [L25]
- Water memory and homeopathy [L29]
- Bio-catalysis from primitive immune system

## 6.2 Quantum credit card

The receiving system serving as energy storage would be analogous to a population reversed laser and one can imagine at least two new physics options for the laser like system.

### 6.2.1 Two realizations for the "population inverted laser"

The two options could be realized for ordinary matter at biological body and for dark matter at the magnetic body respectively.

1. One possibility is provided by zero point kinetic energy depending on the size scale of the space-time sheets  $E \sim \hbar^2 \pi^2 / 2mL^2(k)$ , where  $L(k)$  is the p-adic length scale given by p-adic length scale hypothesis stating that p-adic primes  $p \simeq 2^k$ ,  $k$  integer are favored.  $m$  refers to the mass of the particle transferred between space-time sheets as the laser like system is excited or de-excited. I have considered the identification for a hierarchy of metabolic energy quanta in terms of p-adic length scales coming as square roots of powers of two and defining a hierarchy transition energies which are not identifiable as ordinary molecular transition energies [K5]. The ordinary metabolic energy quantum whose nominal value can be taken as .5 eV belongs to this hierarchy and corresponds to proton for atomic p-adic length scale  $L(139)$  or to electron Cooper pair with p-adic length scale  $L(149)$ . From  $m_p/2m_e \simeq 2^{10}$  and from the ratio of p-adic mass scales  $2^{(149-139)/2} = 2^5$  it follows that zero point kinetic energies are approximately the same. This option makes sense for visible matter and also for dark matter: the zero point kinetic energies are same since  $L(k, \hbar_{eff}) = (\hbar_{eff}/\hbar)L(k, \hbar)$  is very natural assumption.  $\hbar_{eff} = n\hbar$  is the effective value of Planck constant. This hierarchy most naturally holds true for ordinary matter and I have discussed unidentified spectral lines from outer space as a possible evidence for the existence of this hierarchy.
2. Second option would be natural in dark matter sector for dark matter residing at the magnetic body of a given system serving as the energy storage of the system. The cyclotron Bose-Einstein condensates of bosonic ions or Cooper pairs of fermionic ions would define the analog of population reversed laser. TGD inspired nuclear physics allows also to have bosonic counterparts of fermionic ions behaving chemically in the same manner as their fermionic counterparts [L3]. The excitation energy would be defined by cyclotron energy  $E = \hbar_{eff} f_c$ ,  $f_c = qB/4\pi m$ : here  $q$  and  $m$  are the charge and mass of the charged particle in question. If the value of  $\hbar_{eff}$  is large enough, cyclotron energies are above thermal energy. For ordinary value of Planck constant they are typically very small.

The realization of quantum credit card for the latter option relies on reconnection of the magnetic flux tubes of the system extracting the energy and those associated with the energy storage. The energy storage could be higher onion-like layer of the personal magnetic body of the system or even some other magnetic body. The reconnection is possible only if the magnetic field strengths of reconnecting flux tubes are identical. Therefore the system needing energy should be able to tune the field strength on the receiving flux tubes by varying their thickness (conservation of magnetic flux guarantees that field strength behaves as inverse of the cross-sectional area of the flux tube). The reconnection gives rise to a formation of a flux tube between two systems and the system needing energy can send negative energy received by the excited cyclotron BE condensate.

This mechanism can also be behind the binding of molecules to corresponding receptors allowing the molecule to recognize the presence of the receptor after which the contraction of the flux tube by a phase transition reducing  $\hbar_{eff}$  would bring the molecule to the receptor. Also water memory and homeopathic healing - and also immune system - would rely on the same mechanism. This mechanism appears also in the model of hypnosis as a kind of hijacking of parts of brain of the subject by hypnotist and in the general model of remote mental interactions.

### 6.2.2 Support for quantum credit card mechanism

There is some empirical support for the credit card mechanism.

1. Photons of phase conjugate laser light behaves like negative energy photons in the sense that second law holds true in the reversed direction of geometric time which must be distinguished from experienced time.
2. Popp has identified a process equivalent to "sucking of energy" in living matter, interpreting it as an extraction of energy in the form of bio-photons [I48]. Extraction mechanism allows interpretation in terms of sending of negative energy photons, which can also be dark. In

TGD Universe bio-photons would result as dark photons decay in energy conserving manner to ordinary photons [K91]. The decay rate could be very small so that the intensity of dark photons could be quite high.

3. Sleightdogs [I50] can run for several days without eating and no signatures of ordinary metabolism have been found. This phenomenon cannot of course be specific to sleigh dogs. Remote metabolism could explain the phenomenon as an extraction of metabolic energy from non-standard sources in absence of standard sources - say from the magnetic body associated with the collective formed by the dogs.
4. Yan Xin Qigong practitioners report that in so called Bigu state there is no need to eat solid food at all for days, weeks, months or even years. Western science is beginning to take Bigu state (<http://www.scribd.com/doc/40483378/Bigu-by-R-Roy>) seriously [I13] and the first national conference on Bigu state was held at the Pennsylvania State University in 2000, with presenters such as as Rustum Roy, founding director of Penn State's Materials Research Laboratory and Hans Peter Duerr, former director of the Max Planck Institute.

One could argue that these individuals live by utilizing dark light as metabolic energy. Does living matter use quantum credit routinely or only in special situations when ATP-ADP mechanism is not available or the neural processing of incoming information leading to the decision about motor action is too slow? Quantum credit card mechanism allows also to initiate the neural activities preceding motor action in the geometric past and Libet's experiments indeed give support for this. Intentional action could be also seen as a top-down process in reverse time direction in which neural activity would be the last step.

One could also raise a more heretical question: could metabolic energy be always received by quantum credit card mechanism? Could the mysterious "high energy phosphate bond" actually reflect the fact that the metabolic energy is extracted from the magnetic body of ATP or some system containing it? Could energy reservoirs be filled by sending dark photon radiation exciting cyclotron states (EEG would be only one example of dark photons)? Or could ATP → ADP fill energy reservoirs at magnetic body?

The best manner to test this is by studying cells under metabolic deprivation. Ling [I40] has argued that ionic pumps and channels do not actually exist and the experimental support for this was his experimental finding that cells continue to function under metabolic deprivation. This could be also interpreted as support for the hypothesis that the ionic currents flowing through cell membrane are supra currents so that dissipation is very low and pumping is un-necessary. My own argument [K15] runs as follows:

"One can also wonder how metabolism is able to provide the needed energy to this continual construction of pumps and channels and also do the pumping. For instance, sodium pump alone is estimated to take 45-50 per cent of the cell's metabolic energy supply. Ling has studied the viability of the notion of the ionic pump experimentally [I40] by exposing cell to a cocktail of metabolic poisons and depriving it from oxygen: this should stop the metabolic activities of the cell and also stop the pumping. Rather remarkably, nothing happened to the concentration gradients! Presumably this is also the case for the membrane potential, so that the notion of metabolically driven electrostatic pumps seems to fail. Of course, some metabolism is needed to keep the equilibrium but the mechanism does not seem to be a molecular mechanism and somehow manages to use extremely small amount of metabolic energy."

My proposal has been that pumps and channels can be there, but are needed basically for the purpose of taking samples about the state of the cellular environment. This view was inspired by the vision that cell membranes serve as sensors communicating information about the cellular environment to the magnetic body. Metabolic energy is however needed for other purposes and one might argue that the finding of Ling supports the view that a cell in this kind of situation uses quantum credit card to extract energy from some magnetic body.

## 6.3 Comparison of Ling's vision of the cell to TGD view

Gilbert Ling (<http://gilbertling.org>) has proposed a theory of cell and living systems which challenges some basic assumptions of standard cell biology [I45, I40, I41, I42, I25, I38, I39]. This theory has several points of contact with the TGD view about living matter and it is interesting to compare the two approaches.

### 6.3.1 Ling's basic ideas and concepts

Ling challenges the notions of ionic pumps and channels, the notion of high energy phosphate bond, and the prevailing view about the role of ATP as energy currency. Ling also questions the views about the role of water and lipid layers of cell membrane in biology. Reading Ling's article about mitochondria [I39] revealed to me how little is known about living matter and how primitive the theories really are. It is difficult to avoid the feeling that the biochemical approach is a heroic attempt to understand living matter without appropriate concepts and ideas and therefore doomed to lead to a vicious cycle of ad hoc hypotheses.

Ling's finding [I41] that a cell can survive for days under conditions of metabolic starvation is his basic argument in favor of the proposal that ionic pumps do not actually exist and that the transfer of various ions and molecules through cell membrane relies on different mechanisms.

Ling's theory [I40] is summarized in the article "Main principles of Lings physical theory of the living cell" (<http://vladimirmatveev.ru/mainprinciples.html>) by Vladimir Matveev [I45]. Ling introduces several new notions.

#### 1. *The notions of resting state and activated state.*

Biological basic structures in various scales appear in two states: resting state and activated state. These states are characterized by the associations between molecular pairs (to be described below). In the resting state most proteins are folded being covered with ordered water giving rise to several layers at the surface of the folded protein. Some protein however remain unfolded. In active state this layer melts and the protein's charged active sites become active and associations form between them and various ions or other active sites. Some proteins are unfolded also in the resting state. According to Ling ATP, water, and potassium ions ( $K^+$ ) are adsorbed on the active sites of the unfolded proteins in resting state. In the activation ATP molecules are split and they give up phosphate ions to other molecules.

#### 2. *Association between two molecules - call them A and B for definiteness.*

Association of  $B$  with  $A$  means that  $B$  tends to be adsorbed by  $A$ . Ling's argument [I40] goes as follows. Consider molecules  $A$  and  $B$  with opposite charges and assume that  $A$  is fixed in space ( $A$  could be protein and  $B$  ion). The fixing of the position reduces the kinetic energy and therefore reduces the total energy of the pair since Coulomb interaction energy is negative. Therefore the association of the molecules is energetically favored. An example of an associated pair would be protein and ion attaching to a charged active site of the protein, which is either anionic or cationic (negatively or positively charged). In this case one can indeed assume that the position of the protein is fixed.

#### 3. *Selective adsorption of B by A.*

Adsorption probability described quantitatively in terms of affinity of  $A$  with respect to  $B$  - is enhanced by the presence of association so that one can speak of selective adsorption. Affinity of  $A$  with respect to  $B$  is defined as the energy liberated as  $B$  is attached to  $A$ . Electron affinity ([http://en.wikipedia.org/wiki/Electron\\_affinity](http://en.wikipedia.org/wiki/Electron_affinity)) of atom is an especially important affinity. In Ling's theory affinities of various biomolecules or their functional groups with respect to water molecules,  $Na^+$  and  $K^+$  ions, and other functional groups appear as parameters. In particular, the affinities of C=O and N-H groups of the peptide bonds of proteins with respect to water molecules and other such groups are important. Also the affinities of COOH groups of the amino-acid residues containing two COOH groups with respect to  $Na^+$  and  $K^+$  ions are important.

Affinities characterize the state of the molecule: in particular, they are different for the resting state and activated state. For instance, unfolded proteins are highly affine with respect to  $K^+$  in the resting state and with respect to  $Na^+$  in the activated state. The phase transition changing the affinities accompanies the generation of action potential. The challenge is to understand why the affinities with respect to two ions with same charge and naively with same chemical properties are not essentially same. In principle, the definition of affinity as energy liberated in adsorption can explain this in terms of details of molecular chemistry since the geometry of the molecules matters besides charge distribution. The exponential dependence of Boltzmann factors appearing in equilibrium distributions could explain strong dependence of affinity on molecule.

The physical nature of selective adsorption - that is affinity - is assumed to depend on electron density in the functional group considered. Low electron density characterizes the resting state and high electron density the activated state. The main regulator of the electron density is ATP, which has electron acceptor properties ( $Ca^{++}$ , signal factors, hormones, and chemical modifications of proteins serve as regulators) In the resting state ATP adsorbed to the protein site displaces electron density to the adsorption site and when ATP is split, the electron density is transferred to the activated state. This displaced electron density is analogous to "high energy phosphate bond".

#### 4. *Adsorption of water.*

In Ling's theory the role of water [I25] differs from than in standard theory. The polypeptide backbone of any completely unfolded protein has a geometrically regular order of positive (N-H) and negative (C=O) charges of the dipoles. This geometry is complementary to the space between water molecules surrounding the protein. This complementary makes possible multilayer adsorption of water on the protein surface. Large fraction of the cellular water is transformed to an ordered water. The outcome are stronger dipole-dipole interactions (hydrogen bonds are the major contributors). As a consequence, the water layers become a poor solvent as compared to bulk water and solutes are displaced from the volume of the adsorbed water. Ordered water acts like an ice layer serving as a barrier against diffusion of large solute molecules. The ordered water at cell surface is assumed to explain cell's selective permeability.

As the cell is activated, the "ice layer" melts and diffusion into cell becomes possible and is not prevented by lipid layers. Also the selectivity of each functional group of polypeptide changes: instead of a high affinity with respect to water molecules one has a high affinity with respect to the functional groups of the back-bone. This gives rise to secondary structures of protein (such as alpha-helix).

#### 5. *Induction process changing in a phase transition-like manner the associations between molecule pairs.*

Activation process is a thermodynamical phase transition. Ling uses as an analog system magnet, a roughly linearly ordered sequence of magnetizable nails, and iron powder. When the magnet is brought to the system, the first nail is magnetized and magnetizes the second nail, which in turn magnetized the third,... The nails also attract that iron powder. The outcome is the organization of the system to a linear structure minimizing free energy. Skeptics can of course argue that this is just a metaphor involving in essential manner non-locality brought in by the presence of the long range magnetic field. Chemistry is however local and it is difficult to see how the non-locality could creep in without introducing some explicit realization for it. The problem is actually much more general: how it is possible that biomolecules manage to find their associates in the dense molecular crowd: how molecule  $A$  recognizes the presence of molecule  $B$  and how  $A$  and  $B$  then go to find each other to react chemically.

### 6.3.2 The fundamentals of Ling's vision from TGD view point

It came as a surprise that Ling's basic notions have rather direct TGD counterparts in terms of magnetic flux tubes and their dynamics based on reconnection and phase transitions changing the value of  $\hbar_{eff}$  inducing the change of flux tube length.

### The new view about metabolism

More than 15 years ago I used [K5] Ling's finding [I41] related to the ability of the cell to survive under metabolic deprivation as an argument to support the hypothesis that ionic currents are supra currents running with low dissipation; in addition direct measurements support the quantal character of these currents identified as Josephson currents - in particular the fact that they do not depend on the properties of the membrane in question. Ling does not assume channels and pumps [I38], although in TGD framework they could be present. My cautious proposal has been that they exist for the purpose of taking samples about the molecular environment generating chemical sensory data communicated to the appropriate appropriate part of the magnetic body. In any case, metabolic energy is needed for many other purposes - in particular, in the transition to activated state, and one could argue that Ling's experiments indicate the existence of an unidentified energy source used when ordinary metabolic energy is not available.

The recent view about TGD suggests that magnetic bodies serve as metabolic energy reservoirs analogous to population inverted lasers defined by excited cyclotron BE condensates of electron and proton Cooper pairs and of various ions. Electronic Cooper pairs are preferred because of their small mass. Quantum credit card mechanism would allow the extraction of energy from the BE condensates by sending negative energy dark photon signals leading to de-excitation of the BE condensates. In this framework the questionable notion of high energy phosphate bond could be replaced with the storage of energy of this kind associated with ATP or with a system containing ATP. The loading of metabolic batteries could take place by sending positive energy dark photons to excite the BE condensates in question and solar radiation could do this as it generates ATP from ADP by adding single phosphate ion. In cell respiration dark photons at the magnetic body of molecules providing the energy would do the same thing using essentially the same mechanism involving electrons and transfer of three protons per ATP through mitochondrial cell membrane.

### TGD counterparts for the basic notions of Ling

Ling's vision is very attractive - at least from a TGD point view. One can however wonder whether it can be realized in the framework of standard chemistry. Can the proposed mechanism of association really lead to the selective adsorption? In particular, it is not clear how a given active site of protein can select between ions of same charge? The basic concepts of Ling find natural TGD counterparts and TGD allows one to overcome the restrictions posed by sticking to the framework of standard chemistry.

1. In TGD framework the notion of association would reduce to that of flux tube or a flux tube pair connecting a pair of molecules or molecule (say active site of protein) and ion. Flux tube pair is favored since it allows to interpret reconnection process as touching of closed flux loops associated with  $A$  and  $B$  so that flux tube pair connecting  $A$  and  $B$  is generated.

This view fits also nicely with one of the variants of the model of DNA as topological quantum computer [K25]. For the variant in question the two flux tubes would carry electrons at their ends and the spin states of the two electrons would give rise to 4 states in 1-1 correspondence with DNA nucleotides so that one would obtain a realization of DNA code in terms of flux tube pairs.

Flux tube connections allow without further assumptions an additional selectivity in the sense that they can exist between protein active site and on a particular ion only. As such Ling's proposal cannot distinguish between ions of same charge. TGD allows flux tube connections also between various biomolecules and even between larger structures so that the notion of association is not restricted to protein-ion pairs or pairs of active sites. These connections are absolutely essential for the understanding of DNA transcription, translation and various bio-catalytic processes.

2. Adsorption process would mean a reduction of the length of the flux tube by a phase transition induced by the reduction of the value of  $\hbar_{eff}$  so that molecules would get near to each other and chemical reaction would become possible.

It is intuitively clear that the length of the magnetic flux tube increases by  $\hbar_{eff}/\hbar = n$  in the phase transition  $\hbar \rightarrow \hbar_{eff}$ , or more generally by  $\hbar_{eff,2}/\hbar_{eff,1}$  in the phase transition

$\hbar_{eff,1} \rightarrow \hbar_{eff,2}$ . Consider a momentum eigenstate  $exp(ipz/\hbar_{eff,1})$  with wave vector  $k_1 = p/\hbar_{eff,1}$  defined at a straight flux tube satisfying periodic boundary conditions and therefore satisfying  $k = m2\pi/L$ ,  $L$  the length of the flux tube. Suppose that momentum  $p$  is conserved in the phase transition. This means that wave vector  $k$  is transformed from  $k_1 = p/\hbar_{eff,1}$  to  $k_2 = p/\hbar_{eff,2}$ . To preserve the periodic boundary conditions the length of the flux tube must be scaled by  $\hbar_{eff,2}/\hbar_{eff,1}$ .

3. Induction process would mean a phase transition inducing reconnection process changing the flux tube connections between molecule pairs. This process would be a quantum phase transition. Whether two molecule can associate depends on the values of the local magnetic fields associated with the reconnecting flux tubes. If the values of both the magnetic field and flux tube thickness are same for the two tubes, association is possible. The value of the flux tube thickness allows to discriminate between different ions of same charge. Flux tube thicknesses characterize also the state of the system (resting state and various activated states). It is also possible that the protein can vary the thickness of the flux tube and therefore reconnect with different molecules. The change of flux tube thickness would take place in the quantum phase transition changing the connectedness structure of the net formed by molecules. The phase transition can be seen as a motor action of the magnetic body. Magnetic body "wakes up" in the activation process.

Concrete examples about a process in which flux tube connectivities change in a phase transition-like manner would be melting of the "ice layer" around a folded protein bringing the proteins into "open air". The shortened flux tubes connecting the active sites of the peptide backbone and di-carboxylic amino-acid residues to water molecules would expand in  $\hbar_{eff}$ -increasing phase transition and de-reconnect. Water would transform to ordinary water. The resulting closed flux tubes accompanying amino-acids can reconnect with similar loops associated with other active sites of peptide and various secondary structures (such as  $\alpha$ -helix) of the protein can form. I have discussed TGD inspired models of protein folding in [K3] in a rather light-hearted manner - mainly as an exercise in order to get familiarity with the notion of magnetic flux tube - and it would be interesting to reconsider the situation by characterizing the active sites by values of magnetic field/cyclotron frequency.

4. Why should the  $\hbar_{eff}$  increasing phase transition accompanying the activation process require energy? The following argument suggests an explanation.
  - (a) As explained, the length of the flux tube is proportional to  $\hbar_{eff}$  and therefore changes. What happens to the thickness of the flux tube? The simplest assumption is that magnetic field strength is preserved so that cyclotron energy scales like  $\hbar_{eff}$  if the sheet containing single high frequency boson is transformed to an  $n$ -sheeted state with one low frequency boson at each sheet. This brings to mind Bose-Einstein condensate and one can ask whether the formation of BE condensates of genuine bosons could have a microscopic space-time description as  $n$ -furcations.
 

If bosons are Cooper pairs of fermions one encounters a problem with fermion number conservation in positive energy ontology. In ZEO one can in principle avoid this problem but one can argue that the change of fermion number in quantum jump for the positive energy part of the state is too radical an option. One possibility is allowance of fractional fermion number for a given sheet so that one can say that Cooper pair is de-localized between the sheets. One could also start from many-fermion state so that in the final state one would have one Cooper pair per sheet of the  $n$ -sheeted covering. For very large values of  $n$  this option is highly questionable.
  - (b) The conservation of magnetic flux poses an additional constraint. If the number of sheets becomes  $n$ -fold and the total flux is conserved, the flux of single sheet must be a fraction  $1/n$  the original total flux. Therefore the transition producing  $n$ -sheeted covering of flux tube scales down its cross sectional area roughly by a factor  $1/n$ .
  - (c) A further condition comes from the quantization of magnetic flux telling that the net flux is integer multiple of  $m_i \hbar_{eff,i}$  in the initial state ( $i = 1$ ) and final state ( $i = 2$ ). Conservation of the magnetic flux gives  $m_1 n_1 = m_2 n_2 = m$  so that integer  $m$  giving the flux in units of  $\hbar$  must be divisible both by  $n_1$  and  $n_2$ . Therefore the phase transition



can occur only when the magnetic flux using  $\hbar$  as unit is larger than 1 and the allowed values of  $n_i$  are factors of  $m$ . For large values of integer  $n_2$  this means that the thickness of the magnetic flux in the initial state must be macroscopic.

- (d) What happens to the magnetic energy of the flux tube? By considering a constant magnetic field one easily finds that flux conservation and invariance of  $B$  together with longitudinal scaling imply that the energy is scaled by integer  $n = \hbar_{eff,2}/\hbar_{eff,1}$ . Therefore part of the metabolic energy would be needed to make the flux tubes longer and thus to gain quantum coherence in a longer scale.

One could say that the pumping of the metabolic energy is needed to preserve macroscopic quantum coherence. An attractive idea is that the energy is extracted from some magnetic body by sending negative energy dark photons. The contraction of flux tubes would occur spontaneously and liberate magnetic energy and reduce the value of  $\hbar_{eff}$ . It is natural to interpret this process as dissipation and loss of potentially conscious information.

5. Also the notions of resting state and activated state of biological structure (cell, protein, etc) have natural counterparts in TGD framework, together with the vision about the role of ordered water in biology. I have used the metaphor "cellular winter" for the resting state and "cellular summer" for the activated state induced by the feed of energy to the system so that it begins to self-organize. The TGD inspired model for ordered water ([http://tgdtheory.com/public\\_html/articles/activatedwater.pdf](http://tgdtheory.com/public_html/articles/activatedwater.pdf)) [L5] [K32] relies on topological quantization of the magnetic field giving rise to flux sheets giving rise to layered structure and there is also a connection with the notion of pairs of dark DNA identified as sequences of dark protons at opposite sides of the layer realizing genetic code [L3, K32].

It seems that the basic notions of Ling's theory - in particular the notion of association, which in my view remains questionable in the framework of standard chemistry - find natural counterparts in TGD framework. The view about cell membrane as Josephson junction leads to a new view about nerve pulse with Josephson currents of Cooper pairs of electrons and fermionic ions and of bosonic ions serving in the key role.

The ground state of the axon would correspond to a propagating soliton sequence mathematically analogous to that appearing in the sequence of mathematical pendulums. Nerve pulse would correspond to a propagating perturbation analogous to that obtained by kicking one pendulum to rotate in opposite direction. The detailed modelling of ionic currents is a fascinating challenge, and the view about the pairing of molecules and ions by flux tubes could provide a much more detailed and maybe realistic view about what really happens at cell membrane. It would also allow us to answer the question of whether pumps and channels are needed or whether they could be replaced with the TGD variants of the notions introduced by Ling.

*Clearly, the basic question is whether standard biochemistry based on locality assumption is enough to describe living matter or whether the non-local quantum physics involving dark matter at magnetic flux tubes and transforming living matter from a soup of free ions and molecules to a dynamical Indra's net formed by biomolecules and flux tubes connecting them is needed.*

### Ling's view about ionic pumps and channels as compared to TGD views

Ling has empirical evidence that the prevailing ionic pump paradigm is wrong. The basic assumption of the prevailing theory is that both water molecules and various ions inside cell are free. This determines the kinetic equations used in the modelling of ion concentrations in chemi-osmotic theory [I39]. Ling assumes that in the resting state the important ions are adsorbed to proteins and that the activation of the cell changes the situation.

Besides adsorption also the notions of association and induction are needed in the formulation. Ling also emphasizes the role of the cellular water [I25]. Cellular water is not ordinary water but ordered water forming multilayered coverings of biomolecules in the resting state of the cell. This covering prevents various chemical activities of the molecules below the "ice layer". Only when the ordered water around proteins and other molecules melts, they become active and can participate

biochemical reactions via their active anionic or cationic sites to which ions or other biomolecules attach. In this framework the notions of ionic pump and channel must be given up or reformulated.

This picture is consistent with that provided by TGD. Instead of treating cell interior as a soup of free molecules one must treat the system as a kind of dynamical Indra's web in which flux tube connections are changing all the time. If ions are part of this web, one cannot apply ionic pump theory unless one can neglect the constraints caused by the presence of flux tubes.

*The most important implication is that the web dictates to a high degree what biochemical reactions can occur and also takes care that the reactants are brought together when needed by reducing the value of Planck constant for appropriate flux tubes of the web. This transition also induces phase transitions changing the volume of a given region of cell. Sol-gel phase transition is basic example in this respect. It would seem that the best manner to describe the transfer of various molecules and ions through the cell membrane in TGD framework is as motor activities of the magnetic body of the cell quantum mechanically rather than biochemistry trying to reduce everything to single particle level and to thermodynamics.*

The fact is however that channel and pump proteins exist and must have some function. The minimal function would be taking of samples from the chemical environment. Also in the generation of nerve pulses various voltage-gated ion channels play a key role. As will be found, the construction of a simple model for these channels demonstrates that quantal versions of channels and pumps emerge rather naturally in TGD framework: as a matter of fact, channel and pump proteins realize dark Josephson junctions! In particular, dissipation for ionic pumps is minimized since the transfer of ion through the cell membrane is a purely quantal process involving absorption/emission of Josephson photon with large value of  $h_{eff}$ . The unexpectedly low dissipation indeed served as a partial motivation of Ling in his approach.

### 6.3.3 The role of ATP according to Ling and in TGD framework

The notion of high energy phosphate bond and the real role of ATP in biology has been one of the long standing problems of TGD inspired biology. What is certainly clear is that ATP/ADP in which phosphate ion is transferred to the acceptor molecule is a fundamental process. Often this process is interpreted in terms of the transfer of metabolic energy and the view is that "high energy phosphate bond" carries the energy.

TGD inspired theory of consciousness however suggests a deeper meaning for ATP/ADP process.

1. Negentropic entanglement serves in TGD Universe as a correlate for a conscious experience of understanding: negentropic entanglement (see fig. <http://www.tgdtheory.fi/appfigures/cat.jpg> or fig. 21 in the appendix of this book) would be transferred in the process. The negentropic entanglement need not as such correspond to conscious experience but its presence makes possible conscious experience. Negentropically entangled systems would define what I have called "Akashic records", whose reading by interaction free quantum measurement (and idealized notion) would give rise to conscious experiences. "Akashic records" would be representations defining the reflective level of consciousness giving rise to memories, predictions, sensory and cognitive representations, etc [K93].
2. My own view have been that ATP either carries and provides, generates, or induces a transfer of negentropic entanglement. I have considered all these options. The key observation is that negentropic entanglement is not a single particle property but characterizes the relationship between two particles. If ATP gives  $P$  to a particle  $B$  one would expect that  $B$  is one of the negentropically entangled particles in the final state. The other particle - call it  $A$  - must be negentropically entangled with  $P$ .
3. The recent view about negentropic entanglement forced by Negentropy Maximization Principle [K44] is very simple and leads to a connection with dark matter hierarchy, p-adic physics, and quantum criticality [K44] [L6]. The negentropic entanglement which can result in quantum measurement is always maximal entanglement so that density matrix is proportional to unit matrix and correspond to a value of effective Planck constant equal to the integer

$\hbar_{eff} = n\hbar$  telling the number of the entangled states. Negentropic entanglement is a prerequisite for an experience defining abstraction about the rule having as instances the state pairs appearing in the entangled state. Note that the state pairs are not unique since any unitary transformation acting in the same manner to the two entangled state basis is allowed.

4. In the recent case this would mean that  $P$  and  $A$  at the ends of the exchanged flux tube  $A - - - P$  must have negentropic entanglement characterized by integer  $n$  and that the flux tube  $A - - - P$  associated with ADP in the initial state is associated with molecule  $B$  in the final state. The transfer of negentropic entanglement is indeed in question. The exchange of the flux tube  $A - - - P$  can take place using reconnection process as the basic process.
5. Negentropic entanglement is conjectured to have as a correlate the braiding of the flux tubes connecting the entangled systems. Does this conjecture survive in the recent case? The flux tubes connect two partonic 2-surfaces at the boundary of causal diamond (CD). The space-time correlate for  $\hbar_{eff} = n\hbar$  is the analog of  $n$ -sheeted Riemann surface. At the partonic 2-surfaces the sheets co-incide. Is it possible for the 3-D projections of the  $n$  sheets of single flux tube to become braided (linked and knotted)?

If closed flux loops associated with  $A$  and  $B$  reconnect to form a *pair of* flux tubes connecting them (as suggested above) one has two alternative reconnections and one of them is uniquely selected by the conservation of flux. The first has minimal braiding and second one does not. Therefore two-tube connections do not guarantee that negentropic entanglement always corresponds to non-trivial braiding.

The following argument assigns the braiding to *single* flux tube.

- (a) TGD also predicts another kind of braiding assignable to the ends of string world sheets at which the solutions of the modified Dirac equation are localized by the conditions that electric charge as spin-like quantum number is well defined for them (eigenstate property). The string ends at the 3-D light-like orbit of the partonic 2-surface define a braid and the other ends of strings at other partonic 2-surfaces get braided during time evolution so that space-like braidings are generated.
- (b) The strings seems to be in a natural 1-1 correspondence with magnetic flux tubes defining their cores. If this is the case the braiding for strings corresponds to the braiding for flux tubes idealized with infinitely thin strings. For  $\hbar_{eff} = n\hbar$  one should have a light-like braiding of the ends of strings assignable to different sheets of the  $n$ -fold covering at the orbit of partonic 2-surface and this braiding would induce the space-like braiding.

It must be admitted that the connection between braiding and negentropic entanglement remains an attractive conjecture at this moment.

What does the transfer of negentropic entanglement mean metabolically?

1. As already noticed, Ling does not believe that energy is transferred in this process and "high energy phosphate bond" is certainly a questionable notion. I tend to believe that also energy is transferred as well but the open question is where it comes from. One can argue that the energy is needed to overcome the potential wall separating the states distinguished by different braidings.

*Remarks:*

- (a) Four-dimensional spin glass property of TGD Universe gives rise to a fractal energy landscape and different valleys could be characterized by different braiding structures and phase transitions changing these structures would lead from a valley to another one.
- (b) Spin glass property means breaking of ergodicity. In a phase transition from resting state to activated state a large number of these transitions would occur and  $ATP \rightarrow ADP$  transferring the entanglement would also involve the extracting of energy from some magnetic body to overcome the potential wall.

2. There is a large number of candidates for the carrier of the energy and Ling's findings about metabolic deprivation suggest that several magnetic bodies can in principle provide the metabolic energy. The energy could be assigned to a population inverted cyclotron BE condensate at the magnetic body of  $P$ , ATP, the flux tube  $AP$ , or a larger system containing ATP.

Ling introduces permanently unfolded proteins as a special system and the magnetic body of single unfolded protein or even the system defined by them could be the carrier of the cyclotron BE condensate. One could imagine that under normal circumstances the magnetic body assignable to ATP or a system containing it provides the metabolic energy but under metabolic deprivation (as cells in Ling's experiment [I41]) the metabolic energy could be extracted from some other magnetic body. One can compare ATPs with jam jars in the refrigerator: when the jam jar becomes empty, the jam jars in the cellar can come to the rescue. This would require the generation of magnetic flux tube contact to the bigger energy storage using reconnection mechanism and tuning of flux tube strength and would require some time.

3. I have proposed that in photosynthesis solar photons excite the cyclotron BE condensate of electron Cooper pairs at the magnetic flux tubes of some system. This conforms with the idea that magnetic bodies serve as energy supplies and that the motion of the system defined by magnetic body and biological body is basically transformation of cyclotron energy to kinetic energy, chemical energy, heat and other forms of energy needed by the visible part of the organism. TGD assigns to electron with standard value of Planck constant a causal diamond (CD) with a size, which corresponds to 10 Hz frequency defining a fundamental biorhythm. This would conform with the fundamental role of electrons in metabolic energy storage. There are of course many details to be filled in but this picture looks to me very attractive.

### 6.3.4 Ling's theory from the perspective of TGD inspired theory of consciousness

Ling formulates his theory using *only the notions of biochemistry and thermodynamics*. This means taking a risk since it is not at all obvious that these notions are enough for understanding life. My personal conviction is that one cannot really understand life without a theory of consciousness. Ling ends up with the notions natural in TGD inspired theory of consciousness but a proper justification of these notions remains lacking because it is simply impossible in the conceptual framework used. Basic problem is of course the non-locality of association process having no description in standard biochemistry.

One can indeed interpret the ATP/ADP process also from the point of view of TGD inspired theory of consciousness from *purely quantal perspective*, and I have already discussed the interpretation of the process as a *transfer of negentropic entanglement*.

1. Flux tubes serve as correlates for attention and ATP serves as re-orientation of the attention by inducing reconnection process. In the transition  $A--C\&B----D \rightarrow A----D\&B---C$  by reconnections the attention of  $A$  is directed from  $B$  to  $C$  and attention of  $B$  from  $D$  to  $A$ .  
*Note:* Is direct attention really asymmetric with respect to  $A$  and  $B$ ? Could attention be symmetric at the fundamental level? Is the "directed" only due to the fact that  $A$  is responsible for the variation of flux tube thickness in order to get in tune. The belief that I am aware of the presence of some system but not vice versa might indeed be an illusion: the other system could also be aware about my presence, even in the case that I regard it as "inanimate". It might be however possible to tell which of the two systems performs magnetic motor action generating flux tube connection (by tuning the field value so that reconnection takes place). This argument applies even to the ordinary sensory perception. The conservation of the signed magnetic flux assigns an arrow to the flux tube and gives precise selection rules: the magnitudes of the fluxes are same for reconnected flux tubes of and also signs so that only one reconnection instead of two is possible.
2. Ling's model assigning different roles to permanently unfolded proteins and folded proteins in resting state has a nice interpretation in TGD context. ATPs are attached to the permanently

folded proteins in the resting state. The unfolded protein  $A$  would be connected to the phosphate  $P$  of ATP by flux tube, and one could say that protein  $A$  directs its attention to ATP. The permanently folded proteins would be like guards of a bastion in a permanent wake-up state. In resting state the folded proteins would "sleep" .

3. As the system is activated, the flux tube connection A—PB is generated and one can say that  $A$  directs its attention to  $B$ , which could be ion, other protein, or some invader molecule. If  $A$  has the role of guard, one can expect that  $A$  can control the thickness of the flux tubes of its magnetic body and in this manner tune to detect the presence of other molecules. Therefore the system of unfolded proteins could define the part of cell which is in permanent wake-up state and monitors the state of the cell. Activation would wake up and unfold the folded proteins and the cell would be in a kind of alarm state as long as external perturbation lasts.

## 6.4 Capacitor-like Josephson junctions as systems with large $\hbar_{eff}/h$ ?

Both Tesla coil and magnifying transmitter can be regarded as a pair of systems in which primary drives secondary system with resonant frequency so that energy is transferred to the secondary. Primary has air gap which acts as a switch. Above a critical voltage about 10 V in the air gap a di-electric breakdown occurs and current runs through the gap. What is remarkable is that the duration of the breakdown period is few milliseconds: this is the time scale for the nerve pulse and suggests an analogy with cell membrane which is also a system with ultrahigh voltage between the plates of a capacitor-like system defined by the two lipid layers of the cell membrane. Also the secondary coil, which can be regarded as a plate of capacitor with Earth defining the second plate, develops local di-electric breakdowns seen as "mini lightnings". The analogy with cell membrane suggests that also these breakdowns are mathematically analogous to the generation of nerve pulse. The glossary of the introduction explains the basic notions related to Josephson junctions.

### 6.4.1 Cell membrane as Josephson junction

I have developed a model for cell membrane as Josephson junction leading also to a model of nerve pulse, and there is interesting to see whether the findings of Tesla could be understood in terms of this model.

1. Cell membrane is assumed to be a Josephson junction in which a Josephson current

$$J = J_0 \sin\left(\frac{Ze \int V(t) dt}{\hbar_{eff}}\right) \quad (6.4.1)$$

is running. For a constant resting potential  $V(t) = V_{rest}$  one obtains

$$J = J_0 \sin(\omega t) \quad , \quad \omega = 2\pi f_J \quad . \quad (6.4.2)$$

a current oscillating with the Josephson frequency

$$f_J = \frac{ZeV_{rest}}{\hbar_{eff}} \quad . \quad (6.4.3)$$

$Z$  is the charge of the super-conducting charge carriers. Electronic Cooper pairs with  $Z = 2$  are certainly involved and very probably also bosonic ions and Cooper pairs of fermionic ions. The Josephson currents run along super-conducting space-time sheets.  $V(t)$  varies

rather slowly. Josephson current generates dark Josephson photons with frequencies coming as multiples of  $f_J$  having interpretation in terms of EEG and its generalizations [K22].

The dominating contribution to the membrane voltage is constant resting potential. Besides this there is varying part reflecting various activities near cell membrane and the idea is that dark Josephson photons emitted by Josephson current communicate sensory information about these activities to the magnetic body.

2. Without further assumptions one cannot predict the value of  $\hbar_{eff} = nh$ . One can however end up with a prediction for  $\hbar_{eff}$  by considering a more general situation in which the voltage containing time dependent part - briefly "AC part".

- (a) Suppose that this contribution is periodic with a period characterized by AC frequency  $f_{AC}$ . This does not mean that the AC part is of simple sinusoidal form but only that  $V(t)$  is a superposition of harmonics of some fundamental frequency  $f_{AC}$  containing also a constant part defining the resting potential. The alternating part of voltage is expected to relate closely to cyclotron contribution to the membrane voltage so that cyclotron frequency  $f_c$  of electron, proton or some ion defines a good candidate for  $f_{AC}$  which would depend on cell. Neglecting nuclear binding energies the cyclotron frequencies of ions in given magnetic field are subharmonics of proton's cyclotron frequency.
- (b) The natural assumption is that in dynamical equilibrium the periodicity of Josephson current is that of the alternating current. This gives as the first guess the condition

$$f_J = f_{AC} \quad (6.4.4)$$

One can also consider also sub-harmonics:

$$f_J = \frac{f_{AC}}{l} \quad , \quad l = 1, 2, \dots \quad (6.4.5)$$

so that Josephson radiation would be seen as master and cyclotron radiation as slave. This condition fixes the value of  $\hbar_{eff}$ :

$$\frac{\hbar_{eff}}{h} = l \times \frac{ZeV_{rest}}{hf_{AC}} = n = 1, 2, \dots \quad , \quad l = 1, 2, \dots \quad (6.4.6)$$

From this formula one can readily calculate the value of  $\hbar_{eff}$  assignable to say EEG frequencies and integer valuedness of  $\hbar_{eff}/h$  fixes the spectrum of EEG frequencies and implies that this spectrum can be regarded as union of sub-harmonics of maximum frequencies  $f_{max}$  such that each sub-harmonic corresponds to its own value of  $\hbar_{eff}$ . The cyclotron frequencies of various ions in given magnetic field correspond in first approximation to various values of  $n$  in above equation and by small tuning of the magnetic field strength associated with flux tubes carrying particular kind of ions the same formula applies to all ions.

- (c) For  $f_{AC} = f_J$  option the value of  $\hbar_{eff}$  would be completely fixed by the periodic perturbation and the system produces dark photons with harmonics of Josephson frequency. For more general option  $\hbar_{eff}$  is divisible by integer  $l$  which would naturally relate to p-adicity with p-adic prime appearing as a factor of  $l$ . The results is rather powerful and gives the long sought for quantitative grasp about the hierarchy of effective Planck constants.
3. The integer quantization of  $\hbar_{eff}/h$  implies that the resting potential of the cell membrane obeys integer quantization for given value of  $l$  and that the changes of the membrane potential correspond to quantized change of the charge of the effective capacitor from  $Q = CV$ . The resting potential of the cell membrane is indeed known to be quantized. The unit for the resting potential is known as miniature end plate potential ([http://en.wikipedia.org/wiki/Miniature\\_end-plate\\_potential#Miniature\\_End\\_Plate\\_Potential](http://en.wikipedia.org/wiki/Miniature_end-plate_potential#Miniature_End_Plate_Potential)) of order

$\Delta V = .5$  mV to be compared with the resting potential of order 60 mV. This would give  $\Delta h_{eff}/h_{eff} \sim 1/100 = \Delta n/n$  if neither  $l$  nor  $f_{AC}$  changes. The changes of  $h_{eff}$  would be of order one per cent.

I have made a conjecture that the phase transitions changing  $h_{eff}$  are such that  $h_{eff}/h = n$  is replaced with its factor. In this case the change of  $h_{eff}$  is large and cannot apply in the case considered.  $h_{eff}/h$  can be kept however constant if the change  $l_i \rightarrow l_f$  compensates the change of  $V_{rest}$  so that one would have

$$\Delta \frac{V_{rest}}{V_{rest}} = \frac{l_i}{l_f} - 1 \simeq -\frac{\Delta l}{l} .$$

$l$  is however expected to be rather small integer on basis of the model of EEG so that  $\Delta l$  need not compensate small changes of  $V_{rest}$ .  $h_{eff}/h$  remains also invariant if  $V_{rest}$  and magnetic field defining cyclotron frequency can scale in the same manner. This follows from the basic conditions automatically. If neither  $l$  or  $B$  is changed then a phase transition satisfying  $\Delta n/n < 1$  must occur and proceed via a transition to an intermediate state with  $h_{eff} = h$  - that is ordinary matter.

### 6.4.2 Quantization of the DC voltage of capacitor from the quantization of charge

For a given value of  $f_{AC} = lf_J$  the formula for  $h_{eff}/h$  implies quantization of the capacitor voltage. The quantization of the voltage of a capacitor follows also from the quantization of charge implying  $\Delta Q_{min} = e$  as the minimal change of charge. This gives a condition on the AC frequency  $f_{AC}$ :

$$\Delta \left( \frac{h_{eff}}{h} \right) = l \frac{Ze\Delta V_{min}}{hf_{AC}} = lr \frac{Ze^2}{Chf_{AC}} = k . \quad (6.4.7)$$

Here  $r$  is the number of elementary charges in the pulse changing the voltage. If this condition is assumed to hold true for all values of  $l$  and  $r$ , one can conclude that

$$\frac{Ze^2}{Chf_{AC}} = s = 1, 2, \dots . \quad (6.4.8)$$

and that  $s$  divides  $k$ . This is true for any  $k$  for  $s = 1$ . This would give a quantization condition for  $\lambda_{AC} = c/f_{AC}$ :

$$\lambda_{AC} = \lambda_{min} = \frac{\hat{C}}{2Z\alpha} , \quad \alpha = \frac{e^2}{4\pi\hbar\epsilon_0 c} \simeq 1/137 . \quad (6.4.9)$$

$$\hat{C} = \frac{C}{\epsilon_0} , \quad \epsilon_0 = 8.854 \times 10^{-12} F/m$$

Equivalently, one would have

$$f_{AC} = f_{max} = \frac{c}{\lambda_{min}} = \frac{2Z\alpha c}{\hat{C}} . \quad (6.4.10)$$

$\lambda_{AC}$  as the minimum wave-length is therefore dictated by capacitance. In biological applications  $f_c = f_{max}$  follows.

Before discussing concrete examples note that  $C$  is expressed using Farad as unit: micro-, nano-, and picofarad are more natural units.  $\hat{C}$  having dimension of length makes manifest the geometric meaning of  $C$ . The allowed values of  $f_{AC}$  must come as sub-harmonics of the maximum frequency determined completely by the capacitance.

1. For a plane capacitor one has

$$\hat{C} = \frac{\epsilon_r A}{d} . \quad (6.4.11)$$

Here  $\epsilon_r = \epsilon/\epsilon_0$  is the relative permeability, and  $A$  and  $d$  are the area of the plate and  $d$  the distance between them. For  $\hat{C} = 1$  m one has

$$\lambda_{min} \simeq \frac{\hat{C}}{m} \times 67.5 , \quad f_{max} \simeq \frac{1}{\hat{C}/m} \times 4.4 \times 10^6 Hz . \quad (6.4.12)$$

2. This gives strong bound on the capacitance. For instance, in the experiments of Tesla  $f_{AC}$  is in the range 20 – 100 kHz. For  $f_{AC} = f_{max}$  the corresponding range for  $\hat{C}$  is 1.15 mm-0.23 mm. For  $f_{AC} = f_{max} = 10$  kHz one would have  $\hat{C}/m \simeq 2.30$  mm.
3. Kennelly-Heaviside layer has thickness  $d = 90 - 150$  km and be approximated as a spherical capacitor with

$$\hat{C} = \epsilon_r \times \frac{4\pi R^2}{R - \frac{R^2}{R+d}} \simeq \frac{4\pi R^2}{d} = \frac{A}{d} . \quad (6.4.13)$$

In this case one has  $f_{max} \simeq 19$  minutes.

### 6.4.3 Constraint on cyclotron frequency

The TGD inspired model of EEG [K22] suggests that  $f_J$  assignable to the neuronal membrane is around 5 Hz. This would suggest that it is second sub-harmonic of an ionic cyclotron frequency around 10 Hz (say that of  $Mg^{++}$ ) or the third sub-harmonic of cyclotron frequency of  $Ca^{++}$  equal to 15 Hz. This would support the formulas

$$f_J = \frac{f_c}{l} , \quad f_c = f_{max} = \frac{2Z\alpha c}{\hat{C}} . \quad (6.4.14)$$

Through these equations the field values at magnetic flux tubes, cell membrane potential, and the shape and size of cell membrane would be in tune. This constraint relates cyclotron frequency and therefore the value of the magnetic field at given flux tube to the capacitance. In terms of the magnetic length  $L_B = \sqrt{\hbar/eB}$  this gives rise to the following equivalent correspondences

$$\begin{aligned} L_B &= \sqrt{\frac{r_C \hat{C}}{\alpha}} l , \\ \hat{C} &= \frac{\alpha L_B^2}{l r_C} . \end{aligned} \quad (6.4.15)$$

Some numerical correspondences are helpful in quantitative estimates.  $B = 1$  Tesla corresponds to magnetic length  $L_B \simeq 64.3$  nm, and capacitance of 1 Farad to the "capacitance length"  $\hat{C} = 1.1 \times 10^{11}$  m. Compton length for electron is  $r_C \simeq 2.43 \times 10^{-12}$  m.

Some comments from the point of view of the model of cell membrane as super conductor are in order.

1. The effects of ELF radiation on vertebrate brain suggest the presence of endogenous magnetic field with field strength  $B \simeq 2B_E/5$ , where  $B_E = .5 \times 10^{-4}$  T is the nominal value of the Earth's magnetic field with magnetic length  $L_B = 14.4 \mu m$ . For electron the corresponding value of  $\hat{C}$  would be  $\hat{C} = .62$  m for  $l = 1$ . For large neurons with radius of order  $10^{-4}$  m one has  $\hat{C} \simeq 12.6$  m<sup>2</sup> for  $l = 1$ . For  $l > 1$  the proportionality  $\hat{C} \propto 1/l$  however allows smaller cell sizes.



2. For proton and ions  $\hat{C}$  would be obtained by scaling down the electronic  $\hat{C}$  by the mass ratio  $m_E/Am_p \sim 2^{-11}/A$ ,  $A$  the mass number of nucleus. For proton one would have  $\hat{C} = 3.3 \times 10^{-4}$  m and for  $Ca^{++}$  ion with mass number  $A = 40$  one would have  $\hat{C} \simeq 1.3 \mu\text{m}$ , which corresponds to the length scale of cell nucleus and could characterize nuclear membrane as capacitor.
3. Somewhat unexpectedly, ions would correspond to a capacitor assignable to nuclear membrane whereas electron would correspond to size scale of large neuron. Alternatively large value of  $l$  could allow smaller cell sizes. Electron could also correspond to a multicellular system behaving effectively as a single capacitor by quantum coherence. DNA double strand and its subsystems might also correspond to the capacitor-like systems involved with both electrons, protons, and ions.

#### 6.4.4 What about more general capacitor-like systems?

There is a temptation to assume that the situation for the air gap of Tesla coil and for the capacitor formed by the secondary and Earth is same as for the cell membrane except that the DC voltage is replaced with AC voltage. The generalization might apply quite generally to any capacitor-like system.

1. Now electronic and possibly also protonic Cooper pairs with large  $\hbar_{eff}$  would be the current carriers. Josephson currents would be present all the time. Dielectric breakdown would be analogous to nerve pulse. The analog of the membrane potential would be defined by the voltage associated the Earth's electric field  $E_E \simeq 100 \text{ V/m}$  unless DC voltage is present. Note that the orientation of the capacitor with respect to the Earth's electric field matters. This would define Josephson frequency in absence of other currents and one would have Josephson current even for an ordinary capacitor with frequency  $f_J = ZeV/\hbar_{eff}$ . Same conditions would apply to  $f_J$  and  $f_{AC}$  as for cell membrane system. Only  $V_{rest}$  would be replaced with  $V_E$  so that one would have

$$\frac{\hbar_{eff}}{h} = \frac{ZeV_E}{hf_{AC}l} = n \quad , \quad l = 1, 2, 2, \dots \quad , \quad n = 1, 2, \dots \quad . \quad (6.4.16)$$

for the space-time sheet along which the Josephson current runs. The value of effective Planck constant is therefore completely fixed! Rather remarkably, the proposed amplitude modulation mechanism predicts exactly the same value  $\frac{\hbar_{eff}}{h}$  as ratio of Josephson frequency for ordinary Planck constant and of AC frequency and it might be possible to regard the two mechanisms as equivalent.

2. If *all* capacitor-like systems carry a small oscillatory Josephson current satisfying  $f_J = f_{AC}$  ( $l = 1$  in more general formula) in presence of AC current, one could assign to a capacitor a unique value of  $\hbar_{eff}$  depending on it orientation with respect to Earth's electric field. This would predict production of dark photons with the AC frequency and its harmonics. Also a capacitor added to DC circuit would carry a small dark Josephson current but now one cannot predict the value of  $\hbar_{eff}$  as found in the beginning. This indeterminacy would conform nicely with the quantum criticality of TGD Universe: a small periodic perturbation would fix the value of  $\hbar_{eff}$ . The new physics might be present in ordinary AC circuits and might relate to the poorly understood  $1/f$  noise in electric circuits. Dark Josephson currents and probably also supra currents would be present in ordinary circuits and one might imagine building a technology based on this new form of high  $T_c$  superconductivity.
3. By introducing to the Josephson potential constant part artificially, one can increase the value of  $\hbar_{eff}/h$  and cell membranes have indeed done just so.

### 6.4.5 What $f_J = f_{AC}/l$ condition implies for Earth's electric field?

As argued, if the situation is analogous to asymptotic self-organization pattern, the Josephson current must be periodic having the same periodicity as the external AC voltage. This is guaranteed if  $V_J(t)$  is a superposition of Fourier components coming in multiples of  $f_{max}$ .

1. If this condition is satisfied and if the voltage  $V(t)$  contains a DC part - containing at least the contribution  $V_E$  associated with the Earth's electric field - to the Josephson voltage, then the condition  $f_J = f_{AC}$  reads as

$$f_J = \frac{ZeV_E}{\hbar_{eff}} = \frac{f_{AC}}{l} = \frac{f_{max}}{l} \quad , \quad f_{max} = \frac{2Z\alpha}{\hat{C}} \quad . \quad (6.4.17)$$

The value of  $\hbar_{eff}/h$  for  $f_{AC} = f_{max}$  would be given by

$$\frac{\hbar_{eff}}{h} = \times \frac{eV_E}{hc} \frac{\hat{C}}{2\alpha l} = n \quad . \quad (6.4.18)$$

2. This in turn poses a condition to  $\hat{C}$ . For a plane capacitor one has  $\hat{C} = \epsilon_r A/d$ . This formula applies in good approximation also to spherical capacitor. For a more general capacitor-like system - defined by say folded cell membrane or the neuronal membrane containing also axon and dendites - the capacitance can be parametrized as  $\hat{C} = yA/d$ .

For  $E_E = x \times 100V/m$  one  $eV_E/hc = d \times x \times 10^2 eV/hc \times m^{-1} = d \times 1.24 \times 10^8 x \times m^{-2}$  and one obtains

$$\frac{\hbar_{eff}}{h} = 1.24 \times 10^8 \epsilon_r xy \times \frac{A}{m^2} \frac{1}{2\alpha l} = n \quad . \quad (6.4.19)$$

This translates to a quantization condition for the area of the plane capacitor:

$$A = nl \times A_{min} \quad , \quad A_{min} \simeq \frac{118}{\epsilon_r xy} (\mu m)^2 \quad . \quad (6.4.20)$$

The size scale of the minimal capacitor is that of cell: in cell scale  $nk$  is small integer and therefore also  $n$  is near unity. That condition correctly relates the size scale of the cell to the magnitude of the electric field of Earth strongly suggests that both  $E_E$  and  $B_E$  have been key players in the evolution of life and also supports the vision about Kennelly-Heaviside layer as the analog of cell membrane.

3. As discussed, also Kennelly-Heaviside layer with thickness  $d \sim 100$  km can be approximated as a spherical capacitor with  $\hat{C} \simeq xA/d$ . One obtains expression for  $nl$  from the expression of  $A$  as a multiple of  $A_{min}$  as

$$nl = \epsilon_r xy \times 4.56 \times 10^{24} \quad . \quad (6.4.21)$$

The allowed values of  $n$  and  $l$  are huge. In the case of cell membrane the values of  $l$  would be however rather small. For the value of  $n$  corresponding to  $n \sim l$  one has  $n \leq 2 \times 10^{12}$ . The frequency of dark variants of visible photons with energy 2 eV would correspond to dark photon with frequency around 150 Hz, which is somewhat above EEG range.

### 6.4.6 Cell membrane, DNA double strand, and cortical layers as capacitor-like Josephson junctions

Earth's electric field  $E_E$  would not allow large  $h_{eff}$  Josephson photons generated by capacitor-like Josephson junctions with much larger size than that of cell. By previous arguments neurons can emit large  $\hbar$  Josephson photons and the high value of the resting potential saves the situation: large  $h_{eff}/h$  as a prerequisite of intelligent life provides the answer to the question why strong voltages are needed in biology. The resting potential  $V_{rest} = .06$  V is by a factor  $x = V_{rest}/E_E d \simeq 6 \times 10^4$ ,  $d = 10^{-8}$ , stronger than that corresponding to  $E_E$ .

#### Cell membrane as capacitor

Using spherical capacitor as a model for the cell membrane as starting point in the parameterization of capacitances as  $\hat{C} = yA/d$ , the quantization condition deriving from quantization of elementary charges reads as

$$\begin{aligned} \frac{h_{eff}}{h} &= 7.44 \times 10^{14} \epsilon_r y \times \frac{A}{m^2} \times \frac{1}{2\alpha l} = n \ , \\ A &= nl \times A_{min} \ , \ A_{min} \simeq \frac{20}{\epsilon_r y} \times (nm)^2 \ . \end{aligned} \quad (6.4.22)$$

A scale of about 5 nm defines the size scale of the minimal capacitor.  $n \sim 2^{16}$  is possible even for the size scale of cell nucleus.

For a large neuron with size scale of  $10^{-4}$ m one obtains  $h_{eff}/h \sim 10^{10}$ . The area of cell membrane can be increased by folding and cell interior is indeed filled with a folded membrane. This allows even larger value of  $h_{eff}/h$  at neuronal level. Therefore one can understand the required large values of  $h_{eff}/h$  and a direct correlation between the evolutionary level measured by  $h_{eff}/h$  and cell size scale and total membrane area is predicted.

#### DNA double strand as capacitor?

Each DNA nucleotide carries two units of negative charge. Could one somehow assign a pair of cylindrical surfaces with the highly coiled DNA double strand and describe it as a cylindrical capacitor? Where are the positive charges? Are positive charges associated with Earth identified as a cylindrical surface around DNA with radius of order  $L(151) = 10$  nm defining the radius of the chromosome? And is the idealization as a perfect conductor meaning constant charge distribution at the coiled inner cylindrical surface and outer chromosome surface really justified?

In any case, the capacitance of co-axial cable is given by

$$\hat{C} = \frac{2\pi\epsilon_r \times L}{\log(R_2/R_1)} \quad (6.4.23)$$

is good approximation for the capacitance of the system if it behaves as a conductor.  $\hat{C}$  depends linearly on length  $L$ . Similar formula is expected to apply in the first approximation also to the coiled DNA strand defining chromosome. The value of  $h_{eff}/h$  would increase as the total length of DNA strand increases during evolution: for human DNA the length is about  $L \sim 1$  m. The linear charge density per unit length is for double strand  $4e$  per nucleotide pair and makes  $6e/nm$  so that the total charge is  $6eL/nm$  and about  $6 \times 10^9$  for human DNA.  $R_1 = 1$ nm and  $R_2 = 10$  nm are reasonable first estimates.

The expressions for various parameters are

$$\begin{aligned}
\hat{C} &= \frac{2\pi\epsilon_r \times L}{\log(R_2/R_1)} \simeq 14.5\epsilon_r L , \\
f_{max} &= 2Z\alpha \times \log\left(\frac{R_2}{R_1}\right) \times \frac{c}{2\pi\epsilon_r \times L} \simeq 3.2 \text{ MHz} , \\
\frac{\hbar_{eff}}{h} &= n = \frac{24\pi}{l} \times (L/nm) \simeq \frac{1}{l} \times 75.4 \times (L/nm) , \\
L &= nlL_{min} , \quad L_{min} = \frac{1}{24\pi} nm \simeq .13 \text{ Angstrom} .
\end{aligned} \tag{6.4.24}$$

For  $L = 1 \text{ m}$  (of the order of the total length of human DNA) one obtains  $\hbar_{eff}/h \simeq .75 \times 10^{11}/l$ . Cyril Smith [J27] claims that for water memory frequency ratio  $f_h/f_l = 2 \times 10^{11}$  is special: this ratio corresponds in TGD framework to  $\hbar_{eff}/h$  [K32].  $L_{min} \simeq .1 \text{ Angstrom}$  means that non-standard values of Planck constant can be important already for the shortest possible DNA strands.  $f_{max}$  is of order MHz and for largest possible values of  $l$  ( $n = 1$ )  $f_J = f_{max}/l$  is of order  $10^{-5} \text{ Hz}$ :  $n = l$  gives  $f_{max} \simeq 10 \text{ Hz}$  which is perhaps not an accident.

Also proteins are charged (the sign and magnitude of the charge depends on pH of the environment) and this suggests that also they define capacitor type Josephson junctions.

### Cortical layers as Josephson capacitors

TGD Universe is fractal and therefore a highly attractive idea is that also the highly folded layers of various brain areas correspond to capacitor-like systems acting as Josephson junctions. Also the six cortical layers- decomposing to cortical columns of radial size scale of order mm would correspond to Josephson junctions but in smaller length scale. The hierarchy of Planck constants would thus make itself directly visible in the structure of brain.

The total area of cerebral cortex ([http://www.wikilectures.eu/index.php/Function\\_of\\_Cerebral\\_Cortex](http://www.wikilectures.eu/index.php/Function_of_Cerebral_Cortex)) is about  $.25 \text{ m}^2$ . For  $A = .25 \text{ m}^2$  - possibly making sense for the highly neural circuits associated with the highly folded membrane-like structure defined by cortical layers - one would have  $nl = 1.25 \times 10^{14} \times (\epsilon_r/1.18)$  so that  $\hbar_{eff}/h = n \leq 1.5 \times 10^{14} \epsilon_r$  holds true. The frequency of a dark variant of 2 eV visible photon would be about 40 Hz for  $\epsilon_r = 1$ . This happens to be the celebrated thalamo-cortical resonance frequency ([http://en.wikipedia.org/wiki/Recurrent\\_thalamo-cortical\\_resonance](http://en.wikipedia.org/wiki/Recurrent_thalamo-cortical_resonance) suggested to be an important correlate for consciousness.

This estimate can be criticized since the value of the voltage is taken to be the resting potential. 10-20 mV is the typical value of the oscillating EEG potential (<http://en.wikipedia.org/wiki/EEG>) when measured from subdural electrodes and one expects that the constant part has magnitude which is larger: in the case of cell membrane by a factor of order 100. If the ratio is same in the scale of cortex, one would have "resting potential" of order 1.2-2-4 V which is by a factor 50-100 higher than resting potential. The average thickness of human cortex is 2.8 mm - largest for mammals but for mouse (2.2 mm) larger than for macaque (1.7). In the Earth's electric field  $E = 100 \text{ V/m}$  the maximum voltage difference over is 0.28 V of this distance which would be roughly twice the nominal value .06 V of the resting potential. Interestingly, the thickness of cortex is known to be thicker for meditators (<http://www.ncbi.nlm.nih.gov/pmc/articles/PMC1361002/>) [J17]: in principle this means larger value of  $\hbar_{eff}$ . One can wonder what happens when the local section of (folded) cortical layer is not orthogonal to the Earth's electric field. If cortical layer behaves as an ideal conductor, the surface charges should arrange the situation in such a manner that the voltage is same along cortical layers and that the orientation of head does not matter.

The quantization of capacitance basically due the quantization of elementary charges and  $f_J = f_{AC}/l$  condition is rather strong. Cell membrane is however able to change its shape and could find a shape in which the condition is satisfied.

### Artificial life?

The above considerations inspire the question about a recipe for building primitive life forms. Both magnetic and electric fields are needed. Concerning the electric part of the system the following recipe comes in mind.

1. Take a capacitor-like system with as large area as possible and feed in electric field as sum of as strong as possible DC part and AC part. From charge quantization the frequency characterizing the periodicity of AC part must be subharmonic of a fundamental frequency expressible in terms of the capacitance. Capacitance itself and thus the area of capacitor is quantized too. In living matter the quantization rules require a flexible geometry. This might explain why living matter is "soft". Cell membranes can indeed vary their capacitance by deforming their shape. The frequency  $f_{max}$  identified as cyclotron frequency  $f_c$  in turn can be varied by varying the flux tube thickness. Maybe this kind of softness is required for artificial cells too. The resulting system is critical in the sense that it satisfies very strong quantisation conditions but state function for density matrix makes the system critical and thus gives excellent hopes for "self-organized quantum criticality".
2. The inclusion of magnetic fields is certainly an essential element. In the case of cell membrane and DNA one assumes that flux sheets traverse through DNA double strand and cell membrane and also flux tubes connecting DNA and lipids are assumed. How could the magnetic body be realized artificially? In Tesla coil secondary serves both as inductance and capacitor so that also magnetic body is present and is able to perform "motor actions" essential for generating reconnections. Here the identification  $f_J = f_{AC}/l = f_{max}/l = f_c/l$  would give an additional constraint:  $f_c = f_{max}$ .

### Remote metabolism and the question about simplest possible metabolic pathway

Remote metabolism suggests an extremely simple manner to produce ATP without the need for metabolic machinery and allowing to avoid production of free radicals causing molecular damage. This mechanism could explain the reported ability to survive without nutrition described in the introduction [I50, I13].

1. Drop out all initial steps of the oxidative phosphorylation appearing in both photosynthesis and cell respiration ([http://en.wikipedia.org/wiki/Oxidative\\_phosphorylation](http://en.wikipedia.org/wiki/Oxidative_phosphorylation)), and replace the last step involving formation of ATP using ATP synthase (pumping protons against membrane resting potential) with much simpler process.
2. The final step in oxidative phosphorylation involves dropping of 4 protons through the cell membrane. The liberated electrostatic energy goes to ATP as it is formed. The electrostatic energy  $ZeV_{rest}$ ,  $E = eV_{rest} \simeq .06$  eV depends on the charge  $Z$  of the charged particle only. One can therefore imagine several basic units: two Cooper pairs of protons, two Cooper pairs of fermionic ions or two doubly charged ions such as  $Ca^{++}$ , and electron Cooper pairs moving in opposite direction through the membrane could liberate same energy to be used to build ATP. One could even say that resting potential defines fundamental metabolic energy quantum.
3. The loading of metabolic batteries could take place by remote metabolism in very simple manner: charged particles with charge  $\pm 2e$  send negative energy Josephson photon energy  $E = -2eV_{rest}$  to some magnetic body and in this manner gain opposite energy as a recoil energy and is pumped to the other side of the membrane.
4. Note that the fundamental energy quantum would be about .06 eV. Metabolic energy quantum has nominal value of .5 eV. This process would not therefore use dark variants of visible photons (decaying to bio-photons) but dark variants of infrared photons decay to IR counterparts of bio-photons. A killer test for the proposal could be a check whether IR analogs of bio-photons with these energies exist.

Absorption of photons at Josephson frequency is obviously a very primitive manner to receive metabolic energy. What about photosynthesis? Could it rely on the absorption of visible photons at Josephson frequency kicking ions to the other side of the photo-receptor membrane, dropping back spontaneously and transferring their electrostatic energy to the electrons in the electron transport chain? This would eventually lead to the kicking of four protons (or two proton Cooper pairs) through the membrane and generation of ATP? Photosynthesis would transform solar photons as natural metabolic energy quanta assignable with near vacuum extremals to the IR metabolic

energy quanta. In [K90] and accompanying JNL article it is demonstrated that this kind of scenario can be considered.

1. TGD suggests two possible states for cell membrane corresponding to far from vacuum extremals and near to vacuum extremals for Kähler action [K15]. For the latter one the  $Z^0$  contribution to membrane potential would dominate and the energies of charged particles defined by membrane voltage are proportional to  $Q_Z g_Z V_Z$ . Basically due to the large isospin of nuclei the scaling of Josephson energies is large but the energies remain below visible range. If Weinberg angle is reduced from  $p = \sin^2(\theta_W) = .02397$  to  $p = .0295$ , the electrostatic energy differences over membrane for ions are scaled up to energies of visible photons for  $V = .055$  eV [K15].
2. The following argument demonstrates that the questionable assumption about Weinberg angle for near to vacuum extremals is actually un-necessary.
3. From Table 1 below one indeed learns that for  $p = .0295$  and  $eV_{rest} = .055$  eV the Josephson energies for  $Na^+$ ,  $Cl^-$ ,  $K^+$  and  $Ca^{++}$  for near to vacuum extremal using eV as a unit are 2.2, 2.74, 3.07 and 2.31. The peak energies for red, green, blue and white light are 2.19, 2.32, 3.06, and 2.49 eV respectively. For ordinary value of Weinberg angle given by  $p = \sin^2(\theta_W) = .23$ , the energies are below visible energies, and this motivated the hypothesis that Weinberg angle is different for near to vacuum extremals. This hypothesis can be criticized.
4. In the earlier version of the model I however failed to notice that it is Cooper pairs of fermionic ions rather than ions that must be the charge carriers. For Cooper pairs of  $Na^+$ ,  $Cl^-$ , and  $K^+$ ,  $p = .23$  and  $E_J = .04$  eV assignable to visual receptors the Josephson energies are doubled being 2.02, 2.80, 3.02 eV and these energies could correspond to peak energies for visible photons. Therefore there is no need to make the questionable assumption  $p = .02397$  nor to assume that instead of fermionic ions one has their exotic bosonic counterparts allowed by the nuclear string model [L3]. For electron the Josephson energy would be scaled by a factor  $-1 + 1/2p$  to  $E(e) = 1.0859 \times eV_{rest}$  for  $p = .2397$ . For neutrino the energy would be given by  $E(\nu) = -0.0859 \times V_{rest}$ : for  $p = 1/4$  it would vanish by the vanishing of vectorial part of  $Z^0$  charge. For proton the energy would be  $E(p) = (3 - 1/2p)V_{rest} = .914 \times V_{rest}$  and for neutron  $E(n) = V_{rest}/2p = 2.086 \times V_{rest}$ .

Ion	$Na^+$	$Cl^-$	$K^+$	$Ca^{++}$
$E_J(.04 \text{ mV}, p = .23)/eV$	1.01	1.40	1.51	1.76
$E_J(.065 \text{ V}, p = .23)/eV$	1.64	2.29	2.69	2.73
$E_J(40 \text{ mV}, p = .0295)/eV$	1.60	2.00	2.23	1.68
$E_J(50 \text{ mV}, p = .0295)/eV$	2.00	2.49	2.79	2.10
$E_J(55 \text{ mV}, p = .0295)/eV$	2.20	2.74	3.07	2.31
$E_J(65 \text{ mV}, p = .0295)/eV$	2.60	3.25	3.64	2.73
$E_J(70 \text{ mV}, p = .0295)/eV$	2.80	3.50	3.92	2.94
$E_J(75 \text{ mV}, p = .0295)/eV$	3.00	3.75	4.20	3.15
$E_J(80 \text{ mV}, p = .0295)/eV$	3.20	4.00	4.48	3.36
$E_J(90 \text{ mV}, p = .0295)/eV$	3.60	4.50	5.04	3.78
$E_J(95 \text{ mV}, p = .0295)/eV$	3.80	4.75	5.32	3.99
Color	R	G	B	W
$E_{max}$	2.19	2.32	3.06	2.49
energy-interval/eV	1.77-2.48	1.97-2.76	2.48-3.10	

Table 1. The table gives the prediction of the model of photoreceptor for the Josephson energies for typical values of the membrane potential. For comparison purposes the energies  $E_{max}$  corresponding to peak sensitivities of rods and cones, and absorption ranges for rods are also given. R,G,B,W refers to red, green, blue, white. The values of Weinberg angle parameter  $p = \sin^2(\theta_W)$  are assumed to be .23 and .0295. The latter value is forced by the fit of Josephson energies to the known peak energies.

Could photo-reception ([http://en.wikipedia.org/wiki/Photoreceptor\\_cell](http://en.wikipedia.org/wiki/Photoreceptor_cell)) in rods and cones and photosynthesis be initiated by the same first step - a resonant absorption of visible photon by a ionic Cooper pair at its Josephson frequency and kicking it through photosystem II ([http://en.wikipedia.org/wiki/Photosystem\\_II](http://en.wikipedia.org/wiki/Photosystem_II)) part of thylakoid membrane, which would therefore be near-to-vacuum extremal? If thylakoid membranes are near to vacuum extremals, the Josephson energy of proton Cooper pairs would :  $E_J = 2eV_{eff}$ ,  $eV_{eff} = (3 - x) \times eV_{thr}$ ,  $x = 1/2p$ . For  $eV_{thr} = .044$  eV favored by the considerations of [K90] this would give  $eV_{eff} = .040$  eV. This happens to be just the nominal threshold potential for sensory receptors. After the absorption the energy of photon would be transferred to electron transfer chain in far from vacuum extremal region of the thylakoid membrane.

Remote metabolism for visible photons would mean the transfer of ion through thylakoid membrane inside photosystem II induced by sending of negative energy photon. One can wonder whether plants could make photosynthesis more effective by by emitting long wave length dark photons received by a source of visible light. Similar mechanism would make possible active vision.

### 6.4.7 Further comments

The model deserves some further comments.

1. It should be made clear that the basic assumption  $f_J = f_{AC}/l = f_c/l$  is perhaps unnecessarily strong. The idea that Josephson voltages and "alternating voltages" assignable to cyclotron BE-condensates are in resonant interaction requires only  $f_J = (k/l)f_c$ , where  $k/l$  is small rational. It is however easy to generalize the above estimate by replacing  $l$  with  $k/l$ .
2. The above arguments lead to a possibly new mechanism producing dark photons and allowing a control of the value of  $h_{eff}/h$  in terms of periodic perturbation of DC voltage. Also very tight conditions on system parameters, such as for allowed values of  $f_{AC}$  follow and the charge of the charge pulse follow. I have proposed also amplitude modulation as a mechanism of production of dark photons. In this case one modulates high frequency ( $f_h$ ) em field with low frequency ( $f_l$ ) em field and the value of  $h_{eff}/h$  is simply the ratio of frequencies:  $h_{eff}/h = f_h/f_l$ . The mechanism requires that the frequency ratio is integers. The two mechanisms make the same prediction but it is not clear whether one should regard them as equivalent.
3. Especially fascinating is the consistency of the resulting picture with the vision about cell membrane and even larger structures of brain as plane capacitor -like Josephson junctions maximizing their area to maximize the values of  $h_{eff}/h$ . This would give direct quantitative grasp to evolution as increase of  $h_{eff}/h$ .
4. The model provides a quantitative formulation of an old vision. Already more than fifteen years ago I talked about a fractal hierarchy of super-conductors and Josephson junctions [K50] of which the cell membrane is only one representative. I proposed that even the region between ionosphere and Earth's surface could be analogous to cell membrane and that lightnings are analogous to nerve pulses. It was however not possible to concretize the idea at that time. Now the situation has changed.

Kennelly-Heaviside layer of thickness about 150 km could have interpretation as the analog of cell membrane. The analogy with cell membrane as Josephson junction goes actually further. Kennelly-Heaviside layer decomposes to two layers with thickness of order 80 km: the lower one corresponds to atmosphere. 172 km corresponds to the thickness assignable to the electron Compton scale  $L_e(239)$ , which corresponds to the next Gaussian Mersenne prime after  $L_e(167) = 2.5 \mu\text{m}$  defining the size scale of cell nucleus. Therefore  $L_e(237) = 86$  km would correspond to the thickness  $L_e(149)$  of lipid layer and 176 km to the thickness  $L_e(151)$  of the lipid layer associated also with Gaussian Mersenne. Kennelly-Heaviside layer would be the analog of cell membrane and Earth interior the analog of the cell interior in accordance with early speculations [K39, K37].

One can consider an alternative interpretation based on p-adic length scales  $L(k)$  rather than scaled up Compton lengths  $L_e(k) = \sqrt{5}L(k)$ . The p-adic length scale  $L(239)$  -as opposed

to scaled up electronic Compton scale  $L_e(239) = \sqrt{5}L(239)$  is 78.7 km - 20 per cent smaller than 100 km. Remarkably, also  $M_{241}$  is Gaussian Mersenne and corresponds to the scale  $L(241)$  which equals to 157.4 km. The two kinds of tectonic plates (continental and oceanic) would be analogous to the lipid layers of cell membrane. Note that 78.7 km is rather precisely the thickness of the atmosphere above which there is ionosphere [F1]. The thickness of Kennelly Heaviside layer [F2] inside which radio waves used in terrestrial radio communications propagate, has thickness about 150 km which roughly corresponds to  $L(241)$ . Also the fact Continental lithosphere [F3] has typical thickness of 200 km ( $L(239)$ ) whereas oceanic lithosphere is 100 km thick ( $L(237)$ ) fits qualitatively with the proposed formation mechanism of continental tectonic plates.

The first guess for the Josephson frequency would be as Schumann frequency  $f_S \simeq 8$  Hz or at least a frequency which is of the same order of magnitude. From the knowledge of the magnitude of the electric field of Earth and from the value of Schumann frequency one can deduce the value of  $\hbar_{eff}/\hbar$  associated with this system. The radial electric field of Earth is not constant and goes to practically zero within few kilometers. At the surface of the Earth it is about  $E = 100$  V/m so that for 10 km height one has  $eV_E < 1$  MeV to be compared with the membrane potential  $eV_{rest} \simeq .06$  eV. The value of  $\hbar_{eff}/\hbar = ZeV_E/f_S$  would be rather large of order  $\hbar_{eff}/\hbar \sim 10^{19} \sim 2^{63}$ .

5. Tesla argued that the magnifying transmitter generated telluric currents, which could propagate in the scale of Earth. The skin depth for Earth estimated from the resistance which is  $10^{10} - 10^{12}$  times that of copper is in the range 4-40 km and from  $j = \sigma E$  it is clear that also telluric currents decay exponentially with distance travelled so that Tesla's claim cannot hold true in Maxwell's electrodynamics.

One can however ask whether the currents could propagate as dark currents along magnetic flux tubes. In this case the damping would be very small and one can imagine current circuits in the scale of entire Earth. Also Schumann resonances at dark flux tubes would have very high Q-value as opposed to ordinary Schumann resonances whose Q-value (<http://www-personal.umich.edu/~pran/jackson/P506/hw02a.pdf>) is estimated to be about 4 so that one fourth of the energy of the mode is lost during one cycle of duration 1/7.8 seconds.

## 6.5 Tesla's work, biology, and TGD

If TGD world view is correct, remote metabolism could also have technological implications. Three different applications mimicking biology come in mind. The communication with geometric past by sending negative energy photons and receiving positive energy photons - as memory recall and remote sensing; the initiation of motor actions by sending negative energy signal to geometric past; and remote metabolism. Zero energy ontology justifies these ideas.

Energy is the bottleneck of recent day technology. Nuclear energy has well-known problems. Also the use of, say, oil as a fuel produces environmental problems and for long travels - in particular space travel - the needed amount of fuel poses an insurmountable problem. The storage of energy as electric energy has also its difficulties due to the fact that the lifetimes of accumulators are very limited.

Tesla had surprisingly far reaching vision about the means of generating and transferring energy in the future society. Tesla speculated about an analogy with biology: in future technology the energy user would extract energy from environment and do this only when it needs the energy. Tesla also believed that there exist unidentified energy sources. This does not imply their identification with zero point energy (ZPE) as often erratically claimed - ZPE emerged as an outcome of quantum field about which Tesla knew nothing. Tesla also speculated on a connection to biology.

To me the most amazing and perhaps most important finding reported by Tesla is what he called "cold electricity" and as a child of his time interpreted it as an evidence for aether particles and scalar photons. What is amazing is that in TGD framework the reported properties of cold electricity and aether particles suggest an interpretation as Cooper pairs of dark electrons and dark photons (recall that we *know* that dark matter is there!). If this is really the correct interpretation, dark matter would have been discovered more than century ago!



In the sequel I will discuss a simple formula expressing the conditions for the transition to a phase that Tesla called "cold electricity", identified in TGD framework in terms of dark matter - and study its generalization to the case of cell membrane allowing to deduce formulas relating cell membrane critical potential and p-adic length scale assigned to given dark particle. These formulas are of course only guesses based on general principles and on available numbers. If the proposed general principles are not correct, one can forget the formulas!

### 6.5.1 Tesla's work

In this section Tesla's work about energy transmission and cold electricity are briefly discussed. After that TGD inspired interpretation of the findings is discussed.

#### Tesla's vision about energy transmission

Probably already Tesla (<http://en.wikipedia.org/wiki/Tesla>) realized the deep problems related to energy and Tesla's technology based on alternative currents initiated by the discovery of AC magnetic motor became the basis of the modern society and the transfer of information by radio waves the standard.

Tesla's vision was that not only information but also energy could be transmitted as radiation and this served as his motivation in transmitter experiments. The idea (<http://www.teslatech.info/ttmagazine/v1n4/valone.htm>) [H11] was that the energy beam sent to what is now known as Kennelly-Heaviside layer is echoed back and received by the user. The objection against the transfer of energy by radiation is obvious. In Maxwellian world the radiation from energy source propagates to all directions and the power density decreases as  $1/r^2$  with distance. Only a small fraction of radiative energy can be used.

One can of course consider a situation in which geometric optics applies reasonably well: this requires however that the wavelength used is small as compared to the size of the antenna. For 200 kHz corresponding to the highest frequency used by Tesla the wavelength is about 1.5 km. For smaller wavelengths one cannot anymore assume that the radiation is reflected from the upper boundary of Kennelly-Heaviside layer.

To develop this vision Tesla studied so called Tesla transmitters ([http://en.wikipedia.org/wiki/Tesla\\_transmitter](http://en.wikipedia.org/wiki/Tesla_transmitter)) and magnifying transmitters ([http://en.wikipedia.org/wiki/Magnifying\\_transmitter](http://en.wikipedia.org/wiki/Magnifying_transmitter)) [H11], which instead of serving as voltage transformers acted as amplifiers: the primary circuit acted as a resonant driving force so that an energy transfer to the secondary was achieved. These circuits act as both receivers and antennas. The circuits applied dynamic switches based on the di-electric breakdown of the surrounding air and generated in the secondary di-electric breakdowns through surrounding air to surprisingly long distances. Rather interestingly, the duration of resonant period after di-electric breakdown putting the switch on was few milliseconds which is the time scale associated with nerve pulse. I do not know whether anyone has really explained this co-incidence. Also the frequency range studied was 20-100 kHz which corresponds to biological time scales. Tesla discovered in his experiments X rays assignable to the high voltages generated in the Tesla transformer.

Tesla also generated radiation propagating through the Kennelly-Heaviside layer ([http://en.wikipedia.org/wiki/KennellyHeaviside\\_layer](http://en.wikipedia.org/wiki/KennellyHeaviside_layer)) - not yet discovered at that time - making possible radio transmissions: Marconi received Nobel prize for radio sender but Tesla in fact discovered the phenomenon first as was admitted after Tesla's death. Tesla also found the surface of Earth acts as a conductor with resistance roughly  $10^{10}$  times higher than that of Copper. Tesla also discovered Schumann resonance on basis of his measurements. In my opinion the large scale effects related to di-electric breakdown discovered by Tesla are not easy to understand in the framework of Maxwell's electrodynamics and might involve new physics. It is a pity that they are seen only as an entertainment nowadays.

#### Cold electricity

Tesla's findings [H34, H12] (see the book by Lindeman at [http://www.teslasociety.ch/info/NTV\\_2011/free.pdf](http://www.teslasociety.ch/info/NTV_2011/free.pdf) and the article by Akai at <http://www.slashdocs.com/inixhk/longitudinal-waves-cold-electricity.html>) led him to

propose the existence of "cold electricity" running as a visible current along the surface of the Tesla coil in a local direction orthogonal to the wire of the coil and consisting of charge carriers not detectable by ordinary amp-meter but generating ordinary electrons at the target.

Cold electricity was not accompanied by dissipation. For instance, the vacuum tube serving as a diode (conducting current only in single direction) was not heated by the cold currents although it generated light. In other words, the currents in question were not ohmic. This brings in mind super-conductivity not yet known at the time of Tesla's experiments. Cold electricity was thought to appear as a result of a "traffic jam" with very strong local electric field leading to a generation of high electronic surface charge densities. This suggests that a high density of electrons is necessary for the cold electricity to appear in a phase transition-like manner.

Cold electricity gave rise to a force parallel to its direction of propagation. As a child of his time Tesla identified dark electricity as aether particles. Tesla assigned to the cold electricity also scalar waves - longitudinal photons - manifesting as light emitted in dielectric breakdowns associated with air gap of primary coil and secondary coil of Tesla transmitter. Longitudinal polarization explained the force in the direction of motion of the scalar waves. Another possibility is that the momentum of cold currents transforming to that of matter gave rise to this force.

Tesla estimated the velocity of the aether particles and concluded that it was superluminal. Tesla claimed also that the energies and the voltages at the secondary coil were too large to be explained in terms of ordinary circuit theory: the discrepancy between the observed value of the voltage for bifilar coil was by a factor about 9 percent higher than predicted (<http://home.comcast.net/~onichelson/VOLTGN.pdf>) [H41, H40]. This might be understood if the ordinary ohmic dissipation for the cold currents was absent so that the energy of charge carriers was transformed to kinetic or electric energy as a whole. Tesla speculated with an additional energy source as an explanation of the strange energetics.

Cold electricity could be perceived as various bodily sensations for pulse lengths not much shorter than nerve pulse duration of order milliseconds. The accompanying light required very long exposure time to become visible in photos. This would suggest exotic photon-like particles were involved and had to transform to ordinary photons in order to become visible for camera. Human eye was however sensitive to this light.

What was remarkable that the time scale for the dielectric breakdown was measured in milliseconds. This happens to be the time scale of nerve pulse duration associated with the electric field of cell membrane higher than the critical value of electric field for dielectric breakdown in air. This motivates the application of TGD inspired view about quantum biology in order to understand the findings of Tesla.

### 6.5.2 Scalar waves of Tesla in TGD framework

The scalar waves or so called non-Hertzian waves of Nikola Tesla belong to the fringe region of science. Many proponents of free energy believe that scalar waves might provide a basis for a new energy and communication technologies. Tesla himself was isolated from the official science and found no place in text books because his hypothesis about scalar waves did not fit within the framework of the Maxwell's electrodynamics. Personally I justified my personal prejudices against scalar waves by the observation that the formulations for the notion of scalar waves that I had seen seemed to be in a conflict with the cherished gauge invariance of gauge theories. The discussions with a Finnish free energy enthusiast Juha Hartikka however led me to reconsider the status of the scalar waves.

The surprise was that the non-Hertzian waves of Tesla might be possible in TGD framework. The most plausible explanation relies on many-sheeted space-time.

1. TGD allows so called massless extremals (MEs, topological light rays) as non-linear generalization of Maxwellian plane waves. They are characterized by light-like wave vector and polarization vector orthogonal to it and these vectors can also depend on space-time position [K10]. The most general wave is a pulse with arbitrary profile moving along ME with light-velocity along them and preserving its shape.

Since TGD space-time is many-sheeted one can take two waves of this kind on top of each other in the sense that their  $M^4$  projections intersect in some region of  $M^4$ . The effective space-time is defined by a piece of Minkowski space with effective metric which is sum of  $M^4$

metric and deviations of the metrics of sheets from  $M^4$  metric. Effective gauge potentials are sums of the induced gauge potentials. For two MEs the potentials at the two sheets and if the wave vectors can be chosen to be in opposite direction in which case one obtains an effective standing wave with non-vanishing net energy but vanishing 3-momentum and classical spin. Since MEs can carry light-like charge current the resulting system carries non-vanishing charge density and vanishing current. Fourier transforms of the pair give rise to massive spinless states having identification as scalar waves possibly carrying em charge.

In TGD framework classical gauge boson fields of standard model correspond two-sheeted structures - perhaps pairs of MEs connected by wormhole contact pairs having interpretation as gauge boson. One can consider the possibility that the classical space-time correlate for gauge bosons massivation at the level of MEs is this kind of pair of spacetime sheets. For massive gauge bosons the wave vector directions of the two sheets would be opposite in the rest system and spin would be vanishing.

2. The original proposal could have been inspired by the electric-magnetic duality of TGD suggesting a large number of solutions of field equations representing constant energy density configurations of electric field assignable to bio-electrets, which would be in a well-defined sense dual to the magnetic flux tube structures with analogous properties. Also classical gravitational fields generated by classical field energy could be important in the living matter. One must however take this proposal with a big grain of salt since there is no proof for the actual existence of this kind of solutions. Furthermore, one can obtain TGD counterparts of scalar waves as pairs of MEs.

### 6.5.3 Relating Tesla's work to TGD inspired quantum biology

Skeptics can of course argue that if Tesla were right, his claims would have been verified long time ago. Here I disagree. Dark matter represents the deepest puzzle of modern physics, and all attempts to find dark matter identified as exotic particles of main stream quantum field theories have failed. This suggests that some assumption about the nature of dark matter is badly mistaken. Tesla's experiments tested Maxwell's electrodynamics in extreme situations - typically high voltage pulses generated in switching on of a circuit such as occur in dielectric breakdown over air gap. Interestingly, also cell membrane - another physics mystery - has a very high resting potential generating an electric field stronger than that inducing a dielectric breakdown in air. These situations are different from the extreme situations encountered in high energy elementary particle physics: long wave lengths and low frequencies are combined with high voltages, and this makes possible for the hierarchy of effective Planck constants to make itself manifest if it exist.

My TGD inspired educated guess indeed is that the hierarchy of dark matter phase labeled by the value of effective Planck constant implying macroscopic quantum coherence might have made itself manifest in the experiments of Tesla.

#### Cold electricity as dark matter in TGD sense

It came as a surprise to me that Tesla's findings - described in [H34, H12] - could be seen as first experimental indications for dark matter in TGD sense.

Consider first dark photons as counterparts of scalar waves of Tesla.

1. Scalar waves could correspond to dark variants of ordinary photons with a high value of effective Planck constant: later an estimate as the ratio  $h_{eff}/h = ZeV/f_{AC}$  of Josephson frequency and AC frequency will be discussed. In TGD inspired biology bio-photons result in the transformation of dark photon of same energy to ordinary photon. The low intensity of bio-photons can be explained in terms of low rate for this process. This could also explain why a long exposure time was required to make the light emitted in Tesla's experiments visible. If this interpretation is correct, living matter would be an optimal detector of dark matter so that subjective experience would provide the most straightforward proof for the existence of dark matter whereas its detection by using conventional detectors would be more difficult!

2. I have earlier considered the possibility of obtaining scalar photons in TGD framework [K24], and the model of gauge bosons as pairs of fermion and anti-fermion at opposite ends of wormhole contact together with p-adic mass calculations [K46] suggests (one might even argue "predicts") the existence of longitudinal photons with very low mass. They need not be relevant for understanding Tesla's findings if the transfer of dark matter momentum is able to explain the longitudinal force reported by Tesla.
3. Massless extremals (MEs)/topological light rays represent TGD counterparts for Maxwellian radiation fields. Their special feature is that they can carry light-like current and therefore also charge. Local polarization  $\epsilon$  and light-like momentum vector  $k$  are orthogonal to each other ( $\epsilon \cdot k = 0$ ), and the expression for the current in terms of the induced gauge field demonstrates that non-Abelian character of field makes possible charge current. In the Maxwellian case  $\epsilon$  should be non-orthogonal to  $k$ . Hence charged MEs cannot correspond to Tesla's scalar waves. As in standard model, *all* particles look massless in sufficiently short length scales in TGD Universe, and all particles - including also electron - should have MEs as space-time correlates. MEs would therefore naturally correspond to dark electrons behaving like massless particles below Compton length scale of scaled up by  $h_{eff}/h$ .

In TGD framework Cooper pairs of dark electrons could thus serve as counterparts of Tesla's aether particles.

1. In TGD framework cold electricity could correspond to Cooper pairs of super-conducting dark electrons with a high value of effective Planck constant. This would explain the non-ohmic character of dark currents. If the value of  $h_{eff}$  is same for dark photons and dark electrons (this is not necessarily true), the Compton wave length of dark electrons would be by a factor  $E_{photon}/m_e$  smaller than that for dark photons. For a photon energy of 2 eV this would give a reduction factor of order  $4 \times 10^{-6}$ . This wave length is still macroscopic (of order of 1 m) for the needed values of  $h_{eff}/h = n \sim 10^{13}$ . The large value of the Compton length implies that the overlap criterion for electron wave functions is satisfied so that the formation of electronic Cooper pairs is possible and lead to a generation of supra currents which do not dissipate. The absence of ohmic dissipation could explain why the vacuum diode serving as a diode was not heated and also why energetics could not be understood in terms of ordinary circuit theory. One cannot of course exclude the possibility of remote metabolism as an additional energy source.
2. If supra currents are formed, they give rise to a path of smallest resistance so that by standard circuit theory or by hydrodynamical analogy the ohmic current along highly resistive winding of the Tesla coil is effectively replaced with the supra current flowing along its surface.
3. One must make a distinction between supra currents which can run even without any potential difference and oscillatory Josephson currents running in presence of voltage. The first guess is that the supra current runs along the surface of the coil and possible Josephson current runs between the coil and ground and is assignable to the sparks generated by the coil. The generation of supra currents and Josephson currents would be favored by the formation of very high electron densities at the locations of the coil in which the normal value of electric field was very high. Using axon as an analogy, the supra currents would flow along axon and Josephson currents between the lipid layers of the axon.

In the case of DC voltage the emerge of Josephson current with frequency determined by the DC voltage looks natural. For AC voltage the first guess is that dark Josephson current oscillating with the AC frequency (or its harmonic or sub-harmonic as will be proposed later) is established. This however requires a constant shift  $V_J$  of the Josephson voltage so that only current would remain strictly sinusoidal.  $V_J$  might explain why the observed voltage in the secondary coil of Tesla transformer is roughly  $10^3$  times higher than the estimated one.  $V_J$  could reflect the proposed accumulation of charge ("traffic jam") interpreted as a breakdown of the conductivity of the coil and its transformation to a capacitor carrying a constant charge. The claimed loss of the conductor property for the coil for a time interval of few milliseconds could correspond to the generation of supra current along coil and  $V_J$  between coil and ground generating Josephson current and direct Ohmic currents.

4. If super-conducting space-time sheets emerge as dark space-time sheets identifiable as  $n$ -furcations of space-time sheets at quantum criticality and if each sheet carries a Cooper pair of electrons one has the analog of Bose-Einstein condensate. One can assume that the area  $S$  of the critical region of the surface of conductor is that of the partonic 2-surface. The guess is that at criticality the electric flux decomposes into sum of smaller electric fluxes over the sheets of  $n$ -furcation such that the small fluxes are equal to charge  $2e$  of the Cooper pair.

Using  $2e$  as a unit the charge the electric flux over the partonic 2-surface at criticality equals to the value of  $h_{eff}/h = n$  identifiable as the total number of Cooper pairs so that one obtains an estimate for Planck constant in terms of the critical electric flux:

$$\frac{E_{cr}S}{2e} = n = \frac{h_{eff}}{h} . \quad (6.5.1)$$

This allows a pseudo-continuum of critical fluxes.

5. It would seem natural to assume "traffic jam" at some critical value of voltage between the ends of the coil implies Bose-Einstein condensate-like state of large  $h_{eff}$  Cooper pairs, Josephson currents, and supra currents. In principle this critical electric field has nothing to do with the critical field  $E_d$  for the di-electric breakdown of air. The needed phase transition would be forced by the "traffic jam" reducing the ordinary conductivity along the wire of the coil. The traffic jam would occur for some critical voltage  $V_{cr}$  between the ends of the coil.

- (a) One especially interesting value of voltage corresponds to the Compton energy of electron:

$$eV_{cr} = m_e \simeq .5 \text{ MeV} . \quad (6.5.2)$$

Also higher voltages than this were encountered in Tesla's experiments. This condition is non-local condition. One should not confuse  $V_{cr}$  with  $V_J$ , which however can be assumed to emerge in the phase transition.

Later a justification for the condition will be considered. It is also encouraging that in Modanese-Podkletnov effect [H43] involving a capacitor for which the second plate is high  $T_c$  super conductor, radiation pulses allowing no interpretation in standard physics framework are generated above the proposed critical voltage  $eV_{cr} = m_e$ : the TGD inspired explanation of the effect is discussed in [K78].

- (b) Combining this condition with Eq. 6.5.1 one would have

$$E_{cr} = \frac{V_{cr}}{L} . \quad (6.5.3)$$

Here  $L$  the total length of the wire of the coil if the electric field is constant along the wire. Hence di-electric breakdowns would occur as an undesired side effect due to the very strong fields forced by the Eq. 6.5.2. In the case of cell membrane this side effect is used for neural communications using nerve pulses. Conditions of Eqs. 6.5.1, 6.5.2, and 6.5.3 would allow to fix the model to a rather high degree. Already earlier additional assumptions correlating Josephson frequency, AC frequency and the geometric characteristics of the system were considered.

- (c) In air the critical field for di-electric breakdown is  $E_d \simeq 3 \text{ MeV/m}$ . For higher field strengths a complete di-electric breakdown (meaning that air becomes a conductor) takes place.  $E_d$  gives for 17 cm long coil  $eV \simeq m_e$  so that one can understand why dielectric breakdowns tend to occur unless coil is longer than this. Also dielectric breakdowns between subsequent turns of the coil are possible and can be seen as a nuisance. The estimate  $E_{cr} = E_d$  together with the condition 6.5.1 gives for  $S \in \{1 \mu\text{m}^2, 1 \text{ cm}^2, 1 \text{ m}^2\}$ ,  $n \in \{3, 3 \times 10^8, 3 \times 10^{13}\}$ . Note that the size scale of the cell nucleus defines the smallest area for which the dielectric breakdown becomes possible.

- (d) The millisecond duration of the current is same as for nerve pulse. Nerve pulse however occurs when the resting potential is reduced *below* the critical value so that the two phenomena do not obey identical physics. The current however decreases as a function of the voltage above criticality (negative resistance): does this mean that oscillating Josephson currents become dominant charge carriers above criticality and that for cell membrane this dominance is taken to extreme meaning that ohmic currents are practically absent?
- (e) One cannot completely exclude the presence of Josephson currents also below  $V_{cr}$  but due to the absence of  $V_J$  they would not contain the dominating purely sinusoidal component but would have the form

$$J_0 \sin\left(\frac{f_J}{f_{AC}} \cos(2\pi f_{AC} t)\right), \quad f_J = \frac{ZeV}{\hbar_{eff}},$$

and periodicity defined by  $f_{AC}$ . The sine term would oscillate between values

$$\pm J_0 \sin\left(\frac{f_J}{f_{AC}}\right) = \pm J_0 \sin\left(\frac{1}{l}\right), \quad l = 1, 2, \dots$$

if the condition  $f_J = f_{AC}/l$  holds true.

6. The cold currents induce electronic effects - generation of ordinary electrons - at the target. This can be understood if a phase transition to ordinary matter occurred when the criterion for the presence of the multi-furcation is not satisfied anymore. An explosion of a copper wire as it received cold electricity was reported by Tesla. This could be understood if the proposed criticality criterion was not satisfied so that the dark current was transformed to ohmic current heating the copper wire.
7. Tesla reported that dark electricity flowed with superluminal velocity and even determined this velocity. This is in principle possible in TGD Universe: sub-manifold gravity implies that the light velocity determined operationally from the time for the signal to travel between two points along light-like geodesics defined with respect to the induced metric depends on space-time sheet. In TGD inspired cosmology this light velocity is lower than the light velocity empty Minkowski space (geodesics of  $M^4$  instead of those of space-time surface  $X^4$ ). If the dark space-time sheets are nearer to  $M^4$  than ordinary space-time sheets, the effective super-luminality follows.
8. Cold currents were not seen by amp-meter but caused subjective sensations and were visible. This conforms with TGD view about the role of dark matter in biology.

This scenario leads to concrete (almost -) predictions.

1. If amplitude modulation is the mechanism generating dark photons, the values of Planck constants involved should come as ratios of frequencies involved: only integer ratios for the frequencies can produce dark photons.
2. The energies of ordinary photons generated form a continuum such that highest frequencies correspond to frequencies assignable to photons with energy of order  $eV_{max}$ , where  $V_{max}$  is the highest voltage generated by the transmitter. Therefore the energies can be in X-ray region (keV region) and even in MeV region. The frequencies of radio waves used were in the range 20-100 kHz so that the range of values of effective Planck constants can be estimated as frequency ratio if amplitude modulation is the mechanism producing dark photons.
3. There is also the amplitude modulation of radio frequency by a frequency associated with the periodic switching of the current through the air gap caused by the di-electric breakdown. This modulation could transform the radio wave photons to dark photons with same energy but frequency considerably below kHz and these dark fields could in turn modulate the ordinary higher energy photons to dark ones so that one would obtain dark photons with frequencies below kHz and energies up to the  $eV_{max}$ .

### Isn't $eV_{cr} = m_e$ condition rather ad hoc?

The first objection against the condition  $eV_{cr} = m_e$  is that it looks rather ad hoc. The study of Dirac equation shows that for  $V > V_{cr}$  the sign of the energy of electron changes from positive to negative so that the roles of electron and positron change. One can argue that something dramatic must happen in this kind of situation and the phase transition transforming electrons to their dark counterparts is good candidate in this respect.

An analogous situation was expected to result in atomic physics of very heavy atoms as the energy of electron changes sign in the strong electric field of heavy nucleus. It however turned out that something different takes place. In heavy ion collisions exotic pion-like states decaying to electron and gamma pairs with energy very near to  $2m_e$  was observed and this led to a TGD inspired model as lepto-pions identified as bound states of colored excitations of electron [K79]. Darkness in TGD sense had to be assumed since otherwise they would be produced in the decays of weak bosons. Could something similar happen also now?

In zero energy ontology (ZEO) the natural assumption is that the scale of causal diamond (CD) is determined from the condition that the quantity  $E - ZeV$  preserves its sign. This would give  $m_e = eV_{cr}$  condition for the state at rest. The standard quantization condition analogous to the quantization of magnetic flux but applied to 2-surface with Minkowskian signature has the following equivalent forms:

$$\begin{aligned} \frac{ZeVT}{h_{eff}} &= n , \\ \frac{ZeV}{h_{eff}} &= nf , \quad f = \frac{1}{T} . \end{aligned} \tag{6.5.4}$$

The time interval  $T$  corresponds naturally to the time scale of CD (temporal distance between its tips). The condition for  $n = 1$  is consistent implies the quantization condition proposed in previous section and motivated by the model of dark EEG:

$$\frac{ZeV}{h_{eff}} = \frac{f_{AC}}{l} . \tag{6.5.5}$$

The reason is that  $f_{AC}$  in general is harmonic of  $f$ :  $f_{AC} = lf$ ,  $l = 1, 2, \dots$ . Recall that the identification of  $f_{AC}$  as cyclotron frequency for some charged boson is natural and requires that ions for which cyclotron frequencies (atomic weights in good approximation) are not multiples of each other cannot appear on the space-time sheet corresponding to same CD. One cannot however exclude the possibility that space-time sheets continue outside the CD and therefore the possibility that same space-time sheet is contained partially to sub-CD of CD.

### An objection against $eV_{cr} = m_e$ condition from biology

One can invent another objection against the identification  $eV_{cr} = m_e$ . For cell membrane the critical membrane potential for nerve pulse generation is .055 eV rather than .5 MeV so that the criticality condition would not apply in this case. Does this mean that electronic super-conductivity is not possible? Should one give up the criticality condition or generalize it appropriately in this case?

The correct solution of the problem comes from the answer to the question "What happens as voltage becomes higher than the critical value  $V_{cr}$ ?". The conjecture is that  $h$  increases to  $h_{eff}/h = n$  and  $n$ -furcation replaces space-time sheet with its  $n$ -sheeted covering. But what does this mean physically?

To answer it is best to make first clear what we want and see whether we can get it.

1. We want criticality condition in the form  $eV_{cr} = m_e/n$  with such an  $n$  that  $V_{cr}$  corresponds to cell membrane resting potential. Therefore mass is scaled down by  $1/n$ . Somehow particle splits to  $n$  fractions so that the total quantum numbers, in particular mass, remain unchanged.

2. We want p-adicity. Since p-adic length scale hypothesis allows besides standard mass corresponding to the p-adic prime  $p \simeq 2^k$  characterizing the particle also mass values scaled by powers of  $\sqrt{2}$ , the natural guess is that p-adic length scale is increased by a factor  $n = 2^{\Delta k}$ .
3. We want a connection with dark matter in TGD sense:  $h_{eff}/h = n$  should hold true for the resulting state. The resulting state must be interpreted as a many-sheeted structure defined by  $n$ -furcation and all quantum numbers are fractionized so that a given sheet carries  $q/n$  if total quantum number is  $q$ . A longstanding issue has been what this fractionization could mean.

By Maxwell's equations stating that potential difference is same along any path with same end points, the potential along each sheet is the same  $eV_{cr,new} = M/n$ . The new version of the criticality condition  $eV_{cr,new} = M/n$  for single sheet of the  $n$ -fold covering is the analog of the original condition  $eV_{cr} = M$  for single sheeted space-time surface. This interpretation also allows to understand the formula  $E_c = h_{eff}ZeB/M$  for cyclotron energy as a formula for single sheet of covering carrying mass  $M/n$  and charge  $Z/n$ . The charge-to-mass ratio  $Z/M$  remains unchanged but summation over sheets yields the factor  $h_{eff}/h$  to the formula of  $E_c$ . Hence everything is consistent with the original motivation for dark matter hierarchy.

4. One can imagine two alternative mathematical realizations. The dark particle could correspond to a tensor product of  $n$  fractional tensor factors or to a direct sum with a complete de-localization of single fractionalized particle to various branches. For a de-localized fractional single particle state the total quantum numbers would be equal to  $q/n$  rather than the desired  $q$  whereas for tensor product of fractional single particle states the total quantum numbers are  $q$  as desired. Therefore tensor product option seems to be the correct one. The fractionized particle is analogous to a full Fermi sphere with all fractional single particle states filled.
5. One can consider also states for which any number  $1 \leq m \leq n$  of single particle states are filled.  $m = 1$  corresponds to the option with a complete de-localization and  $m = n$  to the states proposed above. I have earlier proposed [K52] that this kind of states - I have called them  $N$ -atoms,  $N$ -molecules, etc... - might allow to understand emergence of symbolic dynamics in living matter. Fractional second quantization for  $n$ -furcations of space-time sheet seems naturally lead to these kind of states. These states allow a natural conjugation operation. A state with  $m$  sheets with each of them containing fractional particle contains holes at the remaining  $n - m$  empty sheets. By replacing holes with particles and particles with holes one obtains a conjugate state. The wild proposal is that the pairing of states and their conjugates by entanglement with maximal entanglement entropy defines the molecular analog of sex. State function reduction would automatically lead to this kind of states having negentropic number theoretic entanglement and Negentropy Maximization Principle [K44] would stabilize them.

This picture is highly predictive. From the knowledge of the membrane critical potential one can calculate the value of  $h_{eff}$  and from the integer quantization of  $h_{eff}/h = n$  gets constraints on the possible values of membrane potential: this constraint is unfortunately rather weak since the values of  $n$  are rather large. Situation changes if the values of  $n$  correspond to powers of 2:  $n = 2^{\Delta k/2}$  so that the mass of the dark particle at given sheet of covering equals to the mass predicted by p-adic mass calculations but in p-adic scale  $k_{eff} = k + \Delta k$ . Note that  $\Delta k$  must be an even number unless one replaces the condition with the approximate condition  $n \simeq 2^{\Delta k/2}$ . This hypothesis might mean that the p-adic physics associated with the sheet of covering indeed corresponds to  $p \simeq 2_{eff}^k$ . The hypothesis predicts the p-adic prime associated with the cell membrane and also restricts strongly the value of the threshold potential of the cell membrane.

1. In the case of electron p-adic length scale hypothesis predicts the value of the threshold potential:  $V_{crit}/V_{cr} = V_{crit}/m_e = n = 2^{\Delta k/2}$ . For  $\Delta k = 46$  one obtains  $eV_{crit} = .060$  eV not too far from the nominal value .055 eV of the threshold potential. The Compton length of scaled up electron would correspond to  $k = 127 + 46 = 173$ , which is  $20 \mu\text{m}$  - a size scale of cell - and longer than the scale  $L_e(167)$ . Note that the ratio  $L_e(173)/L_e(151) = 2^{11}$  is approximately the same as the ratio of proton and electron masses. I have also introduced an ad hoc hypothesis that powers of  $2^{11}$  represent preferred values of  $h_{eff}$ .



2. For biologically important ions one can find the values of membrane critical potential for which  $n$  is power of 2. Since the mass of the ion is in good approximation proportional to mass number in good approximation it is easy to get reasonable estimates for the effective (or maybe real) p-adic length scales associated with ions and for the precise value of the threshold potential. The values of  $k_{eff}$  and electrostatic energy  $E$  in threshold potential are given in Table 2 below.
3. This picture might allow to understand why nerve pulse is generated when the membrane potential is reduced *below*  $V_{crit}$ . The earlier vision about resonant interaction between dark variants of elementary particles and their p-adically scaled up versions with ordinary value of Planck constant and scaled down mass [K37] assumes that dark scaled up Compton length  $nL_c$  equals to the p-adically scaled up Compton length: this quantizes the values of  $h_{eff}/h = n$  to powers of 2. In the case of electron this gives  $n = 2^{\Delta k} = 2^{23}$ . The reduction of the membrane potential below the critical value would transform dark electrons to ordinary electrons. Same applies to dark ions. If this is the case, the ordinary ohmic conduction would set on and lead to a generation of nerve pulse as a phenomenon analogous to di-electric breakdown. This picture could make sense also for the neutrino option. What is remarkable that ZEO and dark matter in TGD sense would be essential for understanding the highly non-intuitive fact that cell membrane system becomes unstable as membrane potential is reduced in magnitude.
4. One can try to determine the order in which different charged particles make a transition to non-superconducting phase during nerve pulse from the ordering of the values of  $E$  as  $(e, p, Cl^-, K^+, Ca^{++}, Na^+)$ . The inward flux of ions however begins with  $Na^+$  ions and the outward flux with  $K^+$  ions. That  $Na^+$  rather than  $K^+$  flow initiates nerve pulse is not a catastrophic prediction: the transition to a non-superconducting phase initiates the dissipative ion flow only if the concentration of non-super-conducting ions on the other side is low enough (not true in the case of  $K^+$  in the beginning of the action potential).
5. Voltage gated ion channels are assumed for all ions. Nerve pulse can be also initiated by voltage dependent calcium channels, and in this case its duration is about 100 ms instead of few milliseconds. The TGD counterparts for the ion channels should exist and the following correspondences are suggestive.
  - Voltage gated ion channel characterized by channel protein  $\leftrightarrow$   $n$ -furcated dark space-time sheet with  $n$  depending on ion.
  - Closed/open ion channel  $\leftrightarrow$  the magnitude of the membrane potential above/below the critical potential.

Voltage gated ion channels would correspond to dark regions of the cell membrane assignable to proteins rather than to the entire membrane as implicitly assumed hitherto. Metabolic economy (minimization of dissipation) would encourage an analogous interpretation in the case of ion pumps. Ionic pumps ([http://en.wikipedia.org/wiki/Ion\\_transporter](http://en.wikipedia.org/wiki/Ion_transporter)) use the energy provided by ATP or the electrostatic energy  $E = ZeV$  (depending on ion only via its charge) provided by the passive transfer of another ion through the cell membrane - the members of the ion pairs might be connected by a magnetic flux tube! The basic mechanism for pumps would be emission/absorption of negative/positive energy Josephson photon kicking the ion or ion Cooper pair to the other side of the membrane and thus same as in the generation of ATP. Quantal ionic pumps dissipate much less than expected, and Ling's approach postulating the absence of pumps is partially inspired by this observation.

There are also questions to be answered. The estimated value of  $n$  is same for  $K^+, Na^+, Ca^{++}$  so that one might expect them to reside at same  $n$ -sheet. Why the channel proteins are different? Do different ions correspond to different cyclotron Bose-Einstein condensates? Could cyclotron frequencies be same or related by powers of two so that local magnetic field strengths would be different and ions should correspond to disjoint parts of magnetic body.

Ion	$H^+$	$Na^+$	$Cl^-$	$K^+$	$Ca^{++}$
$\frac{A}{z}$	1	23	35	19	20
$\frac{E}{meV}$	54.6	38.0	50.0	46.0	44.0
$k_{eff}$	175	189	191	189	189

Table 2. The values of the threshold potential and effective p-adic length scales  $k_{eff} = k + \Delta k$  predicted by assuming  $h_{eff}/h = n = 2^{\Delta k}$ .  $A$  and  $z$  denote the mass number and charge of the ion. For electron one has  $k_{eff} = 173$  (prime) and  $E/meV = 60$ .  $Na^+$ ,  $Ca^{++}$  and  $K^+$  all correspond to same p-adic length scale  $k_{eff} = 189$  (p-adic length scale of 5 mm) if the ion is assumed to correspond to  $k = 113$  for atomic nuclei. Another possibility is  $k = 137$  (atomic length scale) giving  $k_{eff} = 213$  (p-adic length scale of 20 meters) and should be assigned with the magnetic body.

It seems that  $k_{eff}$  could characterize genuine p-adicity that is p-adicity in the same sense as ordinary particle obeys it.

1. I have proposed earlier that dark and possibly also p-adic copies of electroweak physics and color interactions are present in living matter for the p-adic length scales corresponding to Gaussian Mersennes  $M_{G,k} = (1 + i)^k - 1$ .  $k = 151, 157, 163, 167$  defining four scaled up electron Compton lengths  $L_e(k) = \sqrt{5}L_e(k)$  in the range [ $L_e(151) = 10$  nm, ...,  $L_e(167) = 2.5$   $\mu$ m] [K37]. Weak bosons behave as massless particles below these p-adic length scales for both p-adic and dark copies. The presence of these copies of weak physics is suggested by the large parity breaking effects in living matter (chiral selection), which are still poorly understood.
2. The hypothesis implies a large number of satellite p-adic length scales if one assumes that dark variant of particle can transform to ordinary variant of the particle characterized by a given dark scale characterized  $n = 2^{\Delta k}$ .
3. The recent conjecture modifies this hypothesis to a statement that given sheet of n-furcation with fractionized quantum numbers - in particular mass - obeys effective p-adic topology characterized by  $k_{eff} = k + \Delta k$ . In particular, the exotic weak and color physics with massless weak bosons and non-confined color below the p-adic length scale  $k_{eff}$  could be obeyed at given sheet of the covering.

### Neutrino super-conductivity and cognition

The idea that neutrinos are highly relevant for cognition [K56] is rather attractive in TGD framework. One of the oldest ideas of TGD inspired biology is the notion of cognitive neutrino pair identified as pair of neutrino and antineutrino at opposite throats of wormhole contact, which I have however gave up as unrealistic. In the recent formulation this state would correspond to a superposition of photon and  $Z^0$  boson coupling only to neutrinos. In standard model framework the idea about the relevance of neutrinos for biology is of course complete nonsense, but p-adic length scale hierarchy and TGD view about dark matter allows to consider this idea at least half-seriously. The observed large breaking of parity symmetry in living matter (chiral selection) indeed encourages to ask whether the p-adically scaled counterparts of weak gauge bosons could appear in the length scales of living matter.

There is also second wild idea. In [K15, K22] I have considered the possibility that the cell membrane can exist in two states: the first state is far from vacuum extremal and electromagnetic fields dominate whereas the second state is near to vacuum extremal and also classical  $Z^0$  fields are important. The latter option would mean maximal sensitivity to perturbations highly desirable for cells serving as sensory receptors. This leads to a modification of the model of cell membrane resting potential and rather realistic looking estimate for the frequencies for which the retinal sensory receptors have maximum response.

1. For near to vacuum extremal option induced Kähler form is very small and in good approximation electromagnetic and  $Z^0$  potential energies for  $e$ ,  $\nu$ ,  $p$  and  $n$  relate to the threshold value of the electromagnetic potential energy via

$$\begin{aligned}
E(X) &= Y(X) \times eV_{crit} , \\
Y(e) &= (-1 + x) , & Y(\nu) &= 2 - x , & Y(p) &= 3 - x , & Y(n) &= x , \\
x &= \frac{1}{2^p} , & p &= \sin^2(\theta_W) .
\end{aligned} \tag{6.5.6}$$

These formulas generalize to ions and allow to calculate the values of  $V_{crit}$  for near vacuum extremals from the condition  $m(X) \times 2^{-\Delta k} = E(X)$ ,  $X = e, p$  or for an ion with given value of  $A/z$  ( $A$  is mass number and  $z$  is degree of ionization). The modified threshold potential is given by  $eV_{crit} \rightarrow eV_{crit}/Y(X)$  when  $Y(X)$  is near unity. The expressions of  $Y(X)$  are deduced in [K15].

2. The earlier model [K15] made the questionable assumption that for near to vacuum extremals the value of the Weinberg angle is  $p = .0295$ , which is considerably smaller than the value  $p = .23$  assumed for the phase far from vacuum extremals [K15]. This assumption was motivated by the condition that the energies of biologically important ions gained in membrane potential correspond to three peak energies associated with visual receptors. It has however turned out that the ordinary value of Weinberg angle can be assumed without losing this prediction if one assumes that Cooper pairs of ions  $Na^+$ ,  $K^+$ , and  $Cl^-$  rather than ions themselves are the charge carriers. For  $p = .2397$  one obtains  $(E(e), E(\nu), E(p), E(n)) = (1.085, -0.0859, 0.914, 2.086) \times V_{rest}$ . Except for neutrino, the scaling factors are rather near powers of 2. Note that for proton the scaling factor is in good approximation two.
3. Dropping of two proton Cooper pairs in the production of ATP would liberate total energy of about  $4 \times .055 = 0.22$  eV. The problem is that this is roughly one half of the metabolic energy quantum. If two proton Cooper pairs and two neutrino Cooper pairs are dropped, the liberated energy is of the order of the nominal value of the metabolic energy quantum. Could it be that the step producing ATP takes place in the region of cell membrane near to vacuum extremal and that also two neutrino Cooper pairs are involved in the process? Note that this discrepancy is encountered also in standard thermodynamical approach and can be overcome by assigning a gradient of chemical potential to the cell membrane. In quantum approach one cannot use this kind of argument.

If one accepts this picture, neutrino super-conductivity with neutrino Cooper pairs as carriers of  $Z^0$  current becomes in principle possible and is even favored by energetics. I have earlier considered the possibility that neutrinos play a key role in cognition but gave up the proposed realization as unrealistic. In the recent situation one must however reconsider a new variant about the idea of cognitive neutrino Cooper pairs. A nice feature of this notion is that cognition would be shielded from electromagnetic perturbations from environment.

1. One can apply the condition  $E(\nu) = m_\nu$  to see whether it is consistent with the electron and neutrino masses predicted by p-adic mass calculations in the lowest approximation [K41]. For neutrinos one can identify two options giving  $m_\nu \propto \sqrt{s_\nu}$ ,  $s_\nu = 4$  or  $s_\nu = 5$ . For electron one has  $m_e \propto \sqrt{s_e}$ ,  $s_e = 5$ . For  $s_\nu = 5$  masses are identical for same p-adic length scale. For  $s_\nu = 4$  one has  $m_\nu = 2/\sqrt{5}m_e = .89m_e$  in the same p-adic mass scale.
2. Assume the recent Wikipedia value  $p = .23970$  for the Weinberg angle. For electron  $\Delta k = 46$  giving  $k = 173$  (prime) predicts  $V_{eff} = 2^{-23}m_e/(-1 + x) \simeq .0561$  eV differing by 2 per cent from the nominal value .055 eV of the threshold potential for neurons.
3. For  $s = 5$  neutrino  $\Delta k = 54$  gives  $k = 181$  (prime) and  $V_{eff} = 2^{-27}m_e/(2 - x) \simeq .044$  eV differing by 10 per cent from the nominal value .040 eV of the threshold potential for photoreceptors in retina. Interestingly, one has  $E(p) = eV_{eff}(p) = .040$  eV. These observations provide support for the idea that ordinary neurons/visual receptors correspond to far from/near to vacuum extremals, for the p-adic length scale hypothesis, and for the criterion  $m = eV_{eff}$ . Note that the p-adic mass scales for neutrinos and the light variant of electron are longer than those associated with Gaussian Mersennes. This is the case also for the ordinary weak bosons.

These considerations allow to take at least half-seriously the possibility that cell membranes correspond to near to and far from vacuum extremals depending on whether the membrane corresponds to neuron (cognition) or sensory receptor (sensory experience) and that electrons are light and dark for the far from vacuum extremals and neutrinos are light and dark for the near vacuum extremal.

### Magnetic body and topological light rays from the point of view of energy storage and transfer

As noticed, in Maxwell's theory the dispersion of EM waves is problematic from the point of view of energy transmission unless geometric optics applies. In TGD Universe topological light rays possibly associated with magnetic flux tubes make possible precisely targeted communication and this difficulty might be circumvented. Remote metabolism possible in zero energy ontology also involves these structures and brings in additional flexibility.

The system using energy could store it temporarily at its magnetic body and transform the energy of cyclotron BE-condensate into various forms of energy assignable to visible matter. Tesla's vision was that energy transfer could take place in planetary scale by reflecting what he called longitudinal scalar waves from the upper boundary of Kennelly-Heaviside cavity. One can even imagine that the part of the magnetosphere associated with atmosphere, ionosphere, the part of magnetosphere rotating with Earth, or even entire magnetosphere could serve as an energy reservoir from which one could receive energy somehow. One can even ask whether solar radiation automatically takes care of the loading of these energy reservoirs. If so, the only problems to be solved would be how to control the magnetic body of the system using energy and generation of negative energy photons. One can also consider the option in which the magnetic body of the system is loaded by irradiating it with dark photons at cyclotron frequencies.

I have proposed that the generation of dark photons with given integer value of  $\hbar_{eff}/\hbar = n$  is possible by performing amplitude modulation of high frequency radiation with frequency  $f_h$  using low frequency radiation such that the frequencies are related by  $f_h = n \times f_{low}$ . I have not been able to give a convincing justification for this proposal. This would generate dark photons with large value of  $\hbar_{eff}/\hbar = n$ . An open question is whether it automatically also generates dark magnetic flux tubes with accompanying the dark photons or whether they must be generated by a phase transition increasing  $\hbar_{eff}$ . In previous section a mechanism utilizing very strong electric fields and high voltages to generate dark Cooper pairs and dark photons as Josephson radiation from AC current system was discussed.

### Lightnings, ball lightnings, and plasmoids as primitive life forms?

If one takes seriously the idea that Earth's electric field ([https://en.wikipedia.org/wiki/Atmospheric\\_electricity](https://en.wikipedia.org/wiki/Atmospheric_electricity))  $eE_E = 100$  eV/m played the role of the electric field associated with cell membrane during the prebiotic period and also requires that the condition  $eV_{cr} = .5$  MeV for the establishment of dark supra currents along helical structures, one must conclude that the minimal length of this kind of structure is about  $L = 5$  km if the electric field remains constant as function of radial distance. A typical cloud-to-ground lightning flash indeed begins at this height. This would suggest that lightnings are generated when the criticality condition is satisfied.

$E_E$  however weakens with height and the voltage associated with  $E_E$  reaches maximum  $eV_E = .3$  MeV at height of 30-50 km. This is rather near to  $eV_{cr} = .5$  MeV: perhaps lightning is generated when this maximum increases locally above  $V_{cr} = m_e = .5$  MeV. This would mean that lightnings are initiated at much higher heights than thought and by above considerations could involve dark supra currents. This conforms with the recent observations that lightnings produce gamma rays and electrons with anomalously high energies ([https://en.wikipedia.org/wiki/Atmospheric\\_electricity](https://en.wikipedia.org/wiki/Atmospheric_electricity)).

For the electric field  $eE = 3$  MeV/m corresponding to di-electric breakdown in air perhaps assignable locally to the lightning the length would be  $L = 18$  cm. I have proposed that plasmoids consisting of plasma and magnetic fields could correspond to primordial life forms. A charged helical structure carrying current and associated magnetic field defining its magnetic body would serve as a candidate for a plasmoid. Plasmoid and "ground" would define the "plates" of a

capacitor-like system. If this view is correct,  $L = 18$  cm is the minimum size scale of plasmoids (say ball lightnings).

#### 6.5.4 How could this picture relate to biofield research?

Various biofield therapies (healing by touch, remote healing, using electromagnetic fields, etc) rely on the observation that weak electromagnetic fields have effects on living matter and the assumption that this can be used for healing purposes. The article "Biofield Research: A Round Table Discussion of Scientific and Methodological Issues" [J8] gives an overall view about the challenges encountered. Biofield therapies represent alternative and complementary medicine and the attitudes of the mainstream are still very hostile. Bio-electromagnetism is a well-established branch of science studying effects of various kinds of electromagnetic fields on living matter and brain. Interestingly, Tesla is the father of the oldest healing method based on pulsed magnetic field generated by Tesla coil. This method is also accepted by standard medicine. The pain relieving effects of this treatment is still poorly understood. Furthermore, the work of the pioneers of bio-electromagnetism like Blackman and Adey revealed that ELF electromagnetic radiation have essentially quantal effects on brain in frequency-amplitude windows and that the field values involved are extremely small: of order 1-10 V/m in typical experiments [K22]. These effects are also poorly understood.

A further idea not accepted by mainstream medicine is the notion of "subtle energy". The concept is often used in a metaphoric sense and it is not clear whether its meaning is nearer to that of information. A more precise meaning for subtle energy could be as some yet unknown form of metabolic energy. Note that in TGD framework metabolic energy is accompanied by negentropic entanglement and conscious information at some level of the self hierarchy.

In the round table discussion some basic theoretical problems of biofield research were summarized. What happens to the physiology of the healer during healing? What are the receptor systems and transduction mechanisms in the healee? What is transmitted between healer and healee?

TGD allows to consider a possible answer to the latter two questions [K22]. The work of Blackman and others encourages the hypothesis that the effects on vertebrate brain are quantal and correspond to cyclotron frequencies for  $\text{Ca}^{++}$  ions in magnetic field which is  $2/5$  of the Earth's magnetic field (.3 Gauss). For the ordinary value of Planck constant quantal effects are definitely ruled out - the energy of photons would be ridiculously small when compared with thermal energy. This could be used as a justification for the hypothesis about hierarchy of effective Planck constants  $h_{eff}/h = n$  following from the basic structure of TGD, and whose applications are discussed also in this article. If the thickness of the magnetic flux tube can be controlled as one particular magnetic motor action, also the local magnetic field can be varied in certain limits, and the outcome is a narrow frequency window.

The understanding of the amplitude windows for external electric field, call it  $E$ , is more difficult and has been a longstanding challenge. This article suggests the reduction of amplitude window to a window for Josephson energy. Denote by  $\theta$  the angle between the plane of plates of Josephson junction and  $E$ . The energy gained by electron as it moves the distance  $d$  between the "capacitor plates" of a Josephson junction is  $eV = eEd\cos(\theta)$ . It is also to the energy received by dark electron as it receives Josephson photon with energy equal to the electrostatic energy  $eV = eEd\cos(\theta)$ . One can argue that the momentum gained by the electron in the absorption of Josephson photon and thus also that of Josephson photon must be in good approximation tangential to the membrane layer inside which it is confined. Since the momentum of the Josephson photon is orthogonal to its polarization,  $\cos(\theta)$  must be rather near to  $\cos(\theta) = 1$ .

1. The first proposed quantization formula proposed in this article is that Josephson frequency  $f_J = ZeV/h_{eff}$  is sub-harmonic of cyclotron frequency:  $f_J = f_c/l$ ,  $l = 1, 2, \dots$ , with cyclotron frequency  $f_c$  identifiable as the frequency of irradiation. This formula relates the voltage  $V$  assignable to the radiation amplitude to its frequency equal to  $f_c$ .
2. Josephson junction corresponds to a two-layered structure such that the electrostatic energy in the voltage between the outer surfaces of the structure corresponds to electron mass scaled by the value of Planck constant  $h_{eff}/h = n = 2^{\Delta k}$ :  $eV = m_e/2^{\Delta k}$ . This works nicely for cell membrane and the cautious proposal is that it works more generally.

3. A resonant interaction between "large" Josephson junctions and cell membranes is needed and becomes possible by the exchange of Josephson photons if the Josephson energies  $eV$  and the value of  $h_{eff}/h$  - that is  $\Delta k$  are same for the two systems. This gives a quantization condition for the thickness of the "large" Josephson junction using the value of electric field  $E = x$  V/m with  $x$  in the range  $[1, 10]$ :  $eV = eEd\cos(\theta) = eV_{crit} = .055$  eV giving  $d\cos(\theta) = 5.5/x$  cm.  $x = 1$  corresponds to  $\cos(\theta) = 1$  giving that the thickness of the Josephson junction is 5.5 cm: this is roughly the scale of brain hemisphere. Variation of the angle  $\theta$  gives frequency window via  $\cos(\theta) = 1/x$ . At least two frequency windows are reported and correspond to  $x \in [1/2, 1]$  and  $x \in [1/10, 1]$ . Already in the first case the range for  $\theta$  would be 60 degrees. It seems that several values of  $d$  in the range of  $[.55, 5.5]$  cm are required in both cases. They could correspond to p-adic length scales  $L_e(k)$  in the range  $k \in [181, 183]$  for the first case and  $k \in [177, 183]$  for the latter case.
4. Cell membrane as Josephson junction is only a macroscopic description of the situation. Membrane proteins defining channels and pumps are very natural candidates for a more precise microscopic description of Josephson junctions at cell membrane scale.  $Ca^{++}$  channels would be especially interesting in this respect since  $Ca^{++}$  is a boson and can form Bose-Einstein condensates as such. The natural question is what are the microscopic counterparts of Josephson junctions in longer length scales.

What would be transmitted between the healer and healee could be dark photons and possibly also dark electrons and even ions. The ability to generate negentropy would be also transmitted and perhaps a better manner to think about the situation is to regard healer and healee as a single system as long as the flux tube connections generated by reconnection of flux tubes are present. Also remote metabolism in which healee emits negative energy Josephson photons received by healer can be considered.

### 6.5.5 Tesla coils from TGD view point

In the sequel coils considered by Tesla are reconsidered from TGD viewpoint and an attempt to understand in more detail the phase transition to dark matter as a phenomenon accompanying resonance is made.

#### Is the model for the resting potential really consistent with the interpretation of Tesla's experiments?

Is the proposed picture consistent with what happens in Tesla's experiments, where very high voltages somewhat above  $eV_{crit} = m_e$  were created? In living matter the voltage values are much lower and this determines the value of  $n = 2^{\Delta k/2}$ . Does this mean that one has  $n = 1$  in Tesla's experiments? This would be rather disappointing but could quite well make sense for the coil-Earth system regarded as capacitor. In both situations very strong electric fields are encountered and the idea about large value of  $n$  is very attractive.

The solution ansatz assumes generation of light fractional electrons as in the case of cell membrane and starts from the idea that the subsequent turns of Tesla coil are analogous to the lipid layers of cell membrane and define Josephson junctions. The observed radiation assigned to dark currents could also correspond to Josephson radiation.

1. Since electric voltage propagates with finite velocity of order light velocity along the coil, there is a potential difference between corresponding points of two subsequent turns of the coil. Could it be that super-conductivity sets on and oscillatory Josephson currents flow between the two subsequent turns and the observed light emission can be assigned with dark currents is Josephson radiation? The electric field is very strong at points where charge accumulates and one expects phase transition. Since the maximal value of the oscillating potential difference between subsequent turns above critical voltage  $eV_{cr} = m_e$  is smaller than  $eV_{cr}$ , a scaling of electron mass downwards is however expected to occur by the proposed criterion for cell membrane:  $m_e \rightarrow m_e/n$ ,  $n \simeq 2^{\Delta k/2}$ ,  $n = h_{eff}/h$ . Electrons would become light.
2. To estimate  $n$  one can use a simple estimate for the voltage as function of time and angle variable  $\phi$  along the helical coil of radius  $R$  given by equations  $z = KR\phi$ ,  $\rho = R$ . The

distance along coil given by  $s = \sqrt{1 + K^2} R \phi$ . One can express  $K$  as the ratio of height to the total length  $s_{tot}$  of the coil:  $K = h/s_{tot}$ . The voltage is given by  $V(t, \phi) = V_0 \sin[\omega_{AC}(t - \sqrt{1 + K^2} R \phi / c)]$ . The voltage difference between points of subsequence turns with values of  $\phi$  differing by  $2\pi$  is  $\Delta V \simeq (\partial V / \partial \phi) 2\pi = (\partial V / \partial t) 2\pi R \sqrt{1 + K^2} / c$ . Josephson current is given by

$$J = J_0 \sin\left(\frac{\int dt \Delta V}{h_{eff}}\right) = J_0 \sin\left[\frac{2\pi}{f_0} \frac{1}{h_{eff}} V(t)\right] , \quad f_0 = \frac{c}{R\sqrt{1+k^2}} . \quad (6.5.7)$$

3. Near zeros of  $V$  one has in the first approximation  $V(t) = V_0 \omega(t - t_{max})$  and Josephson current behaves as

$$J_0 \sin[\omega_{eff,J}(t - t_{max})] , \quad (6.5.8)$$

where

$$\omega_{eff,J} = (2\pi)^2 \frac{f_{AC}}{f_0} V_0 \frac{1}{h_{eff}} \quad (6.5.9)$$

defines the analog of Josephson frequency for effective voltage

$$V_{eff} = (2\pi)^2 \frac{f_{AC}}{f_0} V_0 . \quad (6.5.10)$$

If one applies the earlier argument this would mean that the critical voltage  $eV_{cr} = m_e$  is scaled down to  $V_{eff,cr} = (2\pi)^2 \frac{f_{AC}}{f_0} m_e$  and that electron becomes dark electron with p-adically scaled down fractional mass at each sheet of multi-furcation.

4. Using the proposed formulas  $h_{eff}/h = n = 2^{\Delta k/2} = V_{cr}/V_{eff,cr}$  one obtains the estimate  $n = (2\pi)^{-2} \frac{f_0}{f_{AC}}$ . For  $R = .1$  m and  $f_{AC}$  in the range  $[20, 10^2]$  kHz one would have  $n$  in the range  $[380, 76]$ . The condition  $n = 2^{\Delta k/2}$  restricts the range to even powers of 2:  $\Delta k = \{16, 14, 12\}$ . The corresponding p-adic scales would be  $L_e(k)$ ,  $k = 127 + \Delta k$  giving  $k = 143, 141, 139$ .  $k = 139$  corresponds to atomic length scale and  $k = 143$  to  $4 \times L_e(139)$ .
5. The surface density of electronic charge carriers should be few electrons per surface area defined by  $L_e(k)$ . This condition looks reasonable since electron density is about one electron per atomic volume. On the other hand, from the critical value of electric field in air the charge density would be only few electron charges per  $\mu\text{m}^2$  (cell size scale). Electrons should indeed separate to its own dark phase at  $n$ -sheet. This would also lead to high charge density for ions inducing dielectric breakdown.

### What traffic jam in Tesla coil could mean?

What "traffic jam" or its analog could mean from the circuit theory point of view and how the traffic jam could be resolved in TGD framework?

#### 1. First trial

In the following a simple manner to illustrate the idea in terms of effective description of coil as L, C, and R in series is discussed first.

1. It is essential that in the experiments of Tesla both primary and secondary coils were in resonance with the same resonance frequency so that primary coil acted as driving force for the secondary and in the resonance created the situation possibly forcing the new physics to emerge via a phase transition to dark matter phase. Primary feeds the secondary with a sinusoidal input at resonance frequency. Modelling the secondary as a circuit with L,C, and R in series, one obtains simple second order differential equation for its behavior

$$\frac{Ld^2I}{dt^2} + R\frac{dI}{dt} + \frac{I}{C} = \frac{dV_{ext}}{dt} \equiv g(t) = A\sin(\omega_0 t) \quad (6.5.11)$$

The right hand side represents the voltage assignable to the primary. For L, C, R in parallel one must express effective R,C, L using the real R, C and L using the formula for  $1/Z$  as sum of  $1/R, 1/C, 1/L$ . Resonance frequency transforms however from  $1/\sqrt{LC}$  to  $\sqrt{R/L}$  in parallel case at the limit of vanishing  $R$ .  $R = 0$  in complete resonance for series is replaced with  $R = \infty$  for parallel case (the current does not flow at all through  $R$  so that the outcome is pure  $L, C$  circuit).

2. Solutions are sums of two solutions of homogenous equation and a special solution of inhomogenous equation. Solutions of the homogenous equation reduce to linear combinations of two exponent functions

$$I_{\pm}(t) = \exp(-\Omega_{\pm}t) \ , \ \Omega = \frac{-R}{2L} \pm i\omega \ , \ \omega = \sqrt{\frac{1}{LC} - \left(\frac{R}{L}\right)^2} \ . \quad (6.5.12)$$

3. The solutions of inhomogenous equation can be obtained by the variation of coefficients for homogenous solutions that is in the form  $I_{\pm}^s = C_{\pm}(t)I_{\pm}(t)$  and are given by

$$I_{\pm}^s(t) = \int_0^t \frac{g(t)}{L} I_{\pm}(t) dt \times I_{\mp}(t) \ . \quad (6.5.13)$$

The outcome from the exponentials is a combination of trigonometric functions and constant functions, which vanish at origin. The resonance corresponds to  $\omega = \omega_0$  and means that the exponential decay for the special solutions is compensated by the energy feed. At the limit  $R/L \rightarrow 0$  the amplitude of  $I_{\pm}$  divergences and the solution for  $R/L$  is combination of trigonometric functions multiplied by  $t$  so that the envelope of the solution increases linearly.

4. Physically the resonance means that the charge of the capacitor oscillates with amplitude, which becomes very large at resonance  $\omega = \omega_0$  (the amplitude is proportional to  $L/R$  at resonance for the series case): note that large inductance makes the resonance stronger. The charge of the coil begins to fluctuate with a large amplitude. To estimate the charge notice that in a reasonable approximation the current has same phase along the coil. The reason is that the voltage represents a signal propagating with almost light velocity along the coil and the phase change  $\Delta\phi = \omega T = \omega L/c \sim 10^{-3}$  and therefore rather small. Charge is given by  $Q(t) = \int I(t)dt$  in good approximation (current all points of coil is in the same phase).
5. Near resonance the amplitude of charge oscillations becomes very large and the system must become unstable. Something must happen. TGD inspired proposal is a transition containing plasma phase and dark matter and dark magnetic flux tubes as a counterpart of Tesla's cold currents.

#### *Second trial*

Second trial is inspired by catastrophe theory.



1. Voltage and frequency would be the control variables and  $|Z|$  could be taken as behavior variable if cusp is assumed to model the situation. There would exist a critical frequency interval inside which two phases are possible. The first phase could be ordinary and second phase could correspond to di-electric breakdown generating plasma and dark currents flowing along dark magnetic flux tubes. This is just one possibility but perhaps the most realistic one. The transition to the phase containing plasma and dark currents takes place at certain frequency above certain critical voltage and frequency range becomes wider as the voltage increases. Plasma can be assigned with the capacitor defined by the di-electric surrounding the coil and the super conducting dark phase with the dark magnetic body of the coil itself. Both are generated at say "the lower" sheet of the cusp. The critical voltage corresponds locally to surface charge density (essentially normal component of electric field at the surface of the conductor) above which di-electric breakdown takes place.
2. The end points of the frequency interval correspond to effective resonances since a sudden transition between the two phases takes place as one approaches the apparent resonance frequency either from below or above. For genuine resonance would result from both sides and hysteresis is basic prediction of this model.  $L, C, R$  change in discontinuous manner inducing discontinuous change of  $Z$ . In particular, the phase changes suddenly and discontinuously so that resonance interpretation is suggestive but would be wrong. Catastrophe theory with  $|Z|$  as behavior variable predicts discontinuity of  $|Z|$  at the transition.
3. The phases have electric *resp.* magnetic character, and would be in certain sense duals of each other. In second phase dissipation is small and therefore also  $|Z|$  is small whereas in the second phase dissipation is larger and  $|Z|$  is large. Whether resistance increases or decreases in the transition to dark plus plasma phase depends on the proportion of the two phases involved.
4. In this picture one does not have genuine resonances but pairs of dual phase transitions. Unfortunately, the testing of this proposal is not easy since the impedances are measured assuming linearity and using rather weak voltages around 1 V whereas plasma phase and cold currents are generated at voltages, which are above kilovolt scale. Intriguingly, the resonances appear in this kind of situation as pairs, and it is possible to reproduce them by a suitable circuit model. It does not look too plausible that small amount of dark phase and plasma could be present at so low voltages but one must have an open mind in this respect.
5. It is possible to obtain also a connection to real resonances since in the vicinity of the resonance frequency the criterion for the formation of plasma is expected to be satisfied for high enough voltage. If the value of surface charge density is what matters then the frequency dependent real part of the charge of the coil defined as integral of the current  $I = V/Z$  near resonance determines the threshold for the generation of the plasma and dark current. The total charge per area of the coil must be above certain critical value corresponding to the critical electric field at which di-electric breakdown occurs. This threshold condition defines the boundaries of the region of  $(V_0, \omega)$  plane inside which the two phases can be present. The phase transition between ordinary and plasma containing phases takes place at its boundaries. Cusp catastrophe would correspond to a frequency interval around resonance.

### Could one detect the generation of dark matter in the behavior of frequency dependent impedance?

The generation of dark matter would involve also the emergence "dark magnetic flux tubes". Dark magnetic flux tube would correspond topologically to the analog of  $n$ -sheeted covering space for  $n = h_{eff}/h$ . Ohmic currents would be replaced with dark supra currents flowing along dark magnetic flux tubes and correspond to Tesla's cold electricity. The generation of strong electron densities and thus strong electric fields at the surfaces of the conductors - in particular coils - is the prerequisite for the phase transition to dark electronic super-conductivity. This would manifest itself as local dielectric breakdowns as in the experiments of Tesla. Resonances mean strong ohmic currents and the phase transition could accompany resonances for sufficiently high voltages.

If the dark magnetic fields correspond to separate space-time sheets carrying dark electron Cooper pairs, there is a temptation to conclude that the presence of the dark currents ("cold

electricity" of Tesla) is not seen in the description of circuits using ordinary circuit theory applying only for the visible matter. In particular, one can argue that the contribution of the induced dark magnetic fields to the inductance characterizing visible matter becomes vanishing. In the framework of circuit theory this would look like a transition to a state in which the visible part of system - say coil - behaves like a capacitor. Here one must make distinction between two meanings of capacitance: could behaves like a charge reservoirs defining together with ground a capacitor like system or could itself becomes analogous to a pair of capacitor plates. If the second end of the system is grounded, these two views seem to be more or less equivalent.

1. In circuit theory description this kind of transition would be analogous to a resonance since it involves a change of the sign of the phase of the frequency dependent impedance  $Z(\omega)$  when the reactance  $X(\omega)$  in the expression of impedance

$$Z = R + iX \quad , \quad X = \omega L - \frac{1}{\omega C}$$

vanishes. Note that system is modelled as  $R, C$ , and  $L$  in series.  $R, C$ , and  $L$  are assumed to be slowly varying functions of frequency  $\omega$  and provide effective reparameterization for the frequency response of a complex system.

Also modelling as  $R, C$ , and  $L$  as parallel is possible and means that inverse of  $Z$  is sum of inverses of various contributions. This means a reparameterization giving:

$$\omega_{\pm} = -i \frac{1}{2RC} \pm \frac{1}{2} \sqrt{-\left(\frac{1}{RC}\right)^2 + \frac{4}{LC}} \quad .$$

One can say that these resonances are duals of each other and related by  $R/L \leftrightarrow 1/RC$ . One can say that the roles of inductance and capacitance are changed in the parallel coupling. Note that at the limit  $R \rightarrow 0$  in parallel case second resonance frequency approaches to  $\omega_{+} = \sqrt{\frac{R}{L}}$ . Note that the limit of very large  $R$  gives  $\omega_{\pm} = \pm 1/\sqrt{LC}$ . The interpretation is that the current does not flow through  $R$  and one obtains pure L,C resonance.

2. The resonances of course have interpretation in terms of ordinary circuit theory thinking and possible phase transitions to dark phase only accompany the resonances. The turns of the coil are insulated from each other and same applies to the primary and secondary of a transformer like system as well as components of a system consisting of several coils. The insulation is obtained by using di-electric which polarizes so that one obtains effectively capacitor like systems since insulating material develops a polarization as a reaction to the charge of the coil. One has effectively L and C in parallel. This gives rise to a resonance frequency. Since C behaves like surface area per distance between the plates, and L is proportional to the length of the coil, the resonance frequency decreases with the size of the coil.

Resonance interpretation in strong sense requires also that the values of the phase are near to  $\pi/2$  for the inductive phase and  $-\pi/2$  for the capacitive phase for R, C, L in series. For R, C, L in parallel the roles of L and C are changed. The strength of the resonance depends on how large the change of the magnitude of the phase angle of  $Z$  is. One has two kinds of resonances depending on the sign of the change of the phase angle as  $\omega$  increases. For R, C, and L in series the transition from capacitive to inductive phase -  $\Phi$  decreases - would correspond to series resonance in ordinary circuit theory, where capacitance dominates at low frequencies for series configurations. Increase of  $\Phi$  could be called "antiresonance". Parallel resonance would correspond to the increase of  $\Phi$  as function of  $\omega$  and decrease for "antiresonance". In the following I will speak only about resonances. The resonance with a phase transition decreasing/increasing  $\Phi$  is expected to be followed by a reverse transition increasing/decreasing it in the case that  $\Phi$  is near  $\pm\pi/2$  between resonances (this requires small enough real part of  $Z$ ).

3. For coils these two kinds of resonances are expected to correspond to different kinds of phase transitions.

- (a) An obvious and directly observable phase transition occurring at resonance is the generation of plasma phase in di-electric breakdown from the surface of di-electric surrounding coil wire or from the di-electric surrounding entire coil. This phase transition dissipates energy, and one expects that resistance increases in the vicinity of the resonance as function of  $\omega$ . This means also maximum for reactance. Phase transition like property would suggest sharp peak like maximum instead of a smooth parabolic maximum.
- (b) The phase transition to dark super-conductivity is expected to be assignable to the coil itself and involve generation of dark magnetic flux tubes and Cooper pairs of dark electrons as current carriers at it. This phase transition is expected to reduce dissipation and induce a peak like minimum in resistance difficult to explain in terms of plasma generation - this assuming that impedance corresponds to the entire current rather than only its visible part. This is the case if the dark current transforms to ordinary one in the measurement of the current-voltage frequency response.
- (c) These two phase transitions have electric *resp.* magnetic character and are could be seen as duals. The data about impedances of certain kind of coils suggests that these phase transitions occur pairwise at nearby frequencies  $\omega_1$  and  $\omega_2$  spanning a frequency range  $[\omega_1, \omega_2]$  inside which the sign of the phase angle  $\Phi$  between current and voltage remains constant. Even  $\Phi$  is expected to be approximately constant for small enough values of resistance. The could be also seen as support for the proposal that resistance has maximum/minimum, which could be assigned with the proposed two kinds of phase transitions.
- (d) There is however a strong objection against this speculative line of thought. Complex circuitry can produce this kind of behaviors without any new physics. This is clear from the rules for the analytic expressions of the circuit parameters as one builds circuit from smaller circuits in parallel or in series. The phase transitions related to new physics should occur for strong electric fields above the threshold for dielectric breakdown. The peaky behavior however occur also for the impedances obtained using low input voltages (actually the only possible manner to determine impedance) so that poor resolution is the natural explanation for it.
4. Since the dark matter resonance could induce (quantum) phase transition and criticality, one expects that various physical observables are in general non-analytic functions of the dimensionless parameter  $(\omega - \omega_0)/\omega_0$  near  $\omega_0$ . This applies also to the phase transition to plasma phase.  $\omega$  would be analogous to temperature and  $\omega_0$  to a critical temperature. Whereas high temperature super conductivity is in finite temperature range, the dark phase would exist in the recent situation in finite frequency range around the resonance frequency (of course, also the temperature range could be finite).
5. Typically non-analytic sharp peaks involving functions  $u^m$ , where one has  $u = |(\omega - \omega_0)/\omega_0|$  and  $m$  is so called critical exponent, appear. For  $|Z|$  one expects have  $m < 1$  meaning divergent and discontinuous derivative at  $\omega_0$ . The sides of the curved "V" (possibly upside down) would be convex - in other words, the derivative would decrease in magnitude as one proceeds from the singularity outwards. Ordinary circuit theory predicts a smooth parabolic behavior  $|Z| = \sqrt{R^2 + bu^2}$  for which "V" would be replaced with what looks like a bottom of a smooth potential well. For very small resistance  $R$  this situation looks in a non-optimal frequency resolution like  $Z \simeq R + ku$  having discontinuous but *finite* derivative at  $\omega_0$ . These are very general qualitative predictions and easily testable using sufficiently high frequency resolution so that the local diffeo-invariants can be identified reliably.
6. It could quite well be that the resonances look like smooth parabolic peaks in good enough frequency resolution. This does not mean that the assignment of phase transition to the resonance is physically wrong. In TGD framework the notion of resolution is an essential part of the physical description and different length scale resolutions correspond to different sheets of many-sheeted space-time. At small space-time sheets the description in terms as ordinary resonances could quite well make sense. Of course, already the usual description of critical systems relies on the notion of resolution - in the recent case for frequency and the successes of the conformal field theory justify fully the notion of resolution.

TGD based view about high  $T_c$  superconductors provides additional insights about the situation.

1. Since charge carriers are concentrated at the surfaces of conductors, conductors are effectively 2-D systems and since quantum TGD itself describes a universe which is effectively 2-dimensional, 2-D conformal field theories with temperature replaced with frequency as an external parameter could provide a lot of theoretical information about the system both at criticality and in its vicinity. Of course, dark phase could also occur in finite temperature range as the properties of living matter suggest. One should of course test whether linearity is true or whether also amplitude of the oscillating voltage could a parameter analogous to the dimensionless parameter  $(\omega - \omega_i)/\omega_i$  so that dark phase would exist also in voltage windows.

By conformal invariance the observables are scaling covariant at criticality and various correlations functions behave in a simple manner at criticality being characterized by anomalous dimensions. In the vicinity of critical point various observables are simple power functions of  $(\omega - \omega_i)/\omega_i$  characterized by critical exponents ([http://en.wikipedia.org/wiki/Critical\\_exponent](http://en.wikipedia.org/wiki/Critical_exponent)). The anomalous dimensions and critical exponents do not depend on the details of the system, and one characterize the system by its universality class near criticality.

2. In TGD inspired model of high  $T_c$  superconductivity the analog of percolation (say (liquid trickling through a porous material) ([http://en.wikipedia.org/wiki/Percolation\\_theory](http://en.wikipedia.org/wiki/Percolation_theory)) serves as a basic mechanism of high  $T_c$  superconductivity. Magnetic flux tubes with relatively small value of  $h_{eff}$  would be present and super-conducting but have short length. In the phase transition to super-conductivity the flux tubes would be scaled up in length and combine to longer ones corresponding to larger value of  $h_{eff}$  and supra currents would flow through the entire wire. In 2-D case the phase transition to percolation is believed to be describable by a 2-D conformal field theory.

There exist rather detailed theoretical results about the behavior of the system at criticality and outside it and it might be possible to extrapolate these results to the recent case. One should be however very cautious since in TGD framework the view about renormalization group evolution crucial for the standard view about criticality is not quite the standard one.

3. Continuous coupling constant evolution having continuous scaling parameter as argument is in TGD framework replaced with a discrete evolution with discrete hierarchy of p-adic length scales replacing continuous scale. All physical states corresponds to fixed points of renormalization group for each p-adic length scale. 2-D conformal field theories indeed describe fixed points renormalization group which the effective 2-dimensionality of TGD Universe implied by strong form of holography and general coordinate invariance conforms with this. Various quantum criticalities differ only in the degree of criticality measured by the number of variables which are critical. In catastrophe theory the singularities of potential function provide a visualization of the situation: the simplest situation occurs with potential has extremum. A more critical situation occurs when also the matrix defined by the second derivatives of the potential function has vanishing determinant. This sequence can be continued indefinitely if the numbers of control parameters and behaviour variables are arbitrarily large.

What does this general picture imply in the recent situation? For instance, should one interpret the entire frequency range in which system is dark super-conductor as critical so that the standard thermodynamical picture assigning criticality only to the phase transition point would not apply as such in quantal situation. It seems that self-organized criticality is nearer to the TGD picture although the critical system is not attractor in the ordinary sense in TGD framework. State function reduction generates critical states and negentropic entanglement and Negentropy Maximization Principle guarantees their stability.

What would be remarkable is that the generation of dark matter phase would be directly measurable using standard measurements. For instance, one could study the frequency dependence of impedance for simple coils and transformers to see whether resonance involving minimum of frequency dependent resistance occur and whether they look like phase transitions - being peaked.

If this is the case, one could study the properties of the system around resonance and try to identify further signatures for dark matter (say Josephson currents between turns of a coil). The conclusion is that it is better to be very cautious: the exotic phenomena are expected to occur for very high voltages and electric fields for which linear circuit theory fails. Peaking however occurs for weak voltages so that they are probably due to poor resolution.

### Could the arrow of time change in electric circuits?

The change of the arrow of geometric time means that dissipation as a loss of energy takes place in reversed time direction. Second law holds still but in a generalized form. In zero energy ontology (ZEO) the quantum jump sequence corresponds to a sequence of pairs of state function reductions to the opposite boundaries of causal diamonds (CDs) defined as intersections of future and past directed light-cones. The arrow of geometric time would change in each state function reduction since the state is prepared state at either boundary and de-localisation occurs at opposite boundary whose position (and thus the size of CD in quantum superposition) varies.

For large enough CDs the arrow of geometric time as perceived by an observer would remain constant. For short time scales characterizing CD the observer would interpret the change of the arrow of time as thermodynamical fluctuations. In living matter the change of the geometric arrow of time might take place continually. Italian theoretician Fantappie indeed suggested long time ago that this might be the case and introduced the notion of syntropy. Syntropy could be interpreted in TGD framework as time reversed counterpart of entropy [J18].

The reversal of the arrow of geometric time implies that the system becomes apparently an over unity system producing energy instead of dissipating it. Since dissipation power equals to  $P = I^2/R$  in circuit theory, time reversal would imply a negative resistance. The concrete signature for the change of the arrow of time is that the magnitude of the phase angle between the current and voltage defined by the impedance would become larger than  $\pi/2$ .

There are indications for this kind of phenomenon in coil like systems. For instance, the measurements of inductance for a coil reported in the master thesis "Voltage distribution along reactor winding under very fast transients" by Salman Ejaz and Saeed Anwar (<http://publications.lib.chalmers.se/records/fulltext/171671/171671.pdf>) demonstrate this kind of effect (Figure 9) [H22]. The graphs of impedance demonstrates also the change of the sign of the phase angle as function of frequency suggesting interpretation as a time reversed resonance. The radical interpretation would be as a temporary change of the arrow of geometric time. Also over-unity effects have been reported - in particular by the free energy community.

The transition to time reversed situation occurs by state function reduction suggesting that it cannot be performed continuously. For a given CD one cannot change the arrow of time in a continuous manner by going through an intermediate frequency for which resistance vanishes. This conclusion does not hold true if the system decomposes a collection of CDs with different arrows of geometric time in the transition.

Skeptic can invent at least the following objections against this interpretation.

1. The system measuring the impedance does not work properly and gives phase whose magnitude exceeds  $\pi/2$  predicted by the positivity of resistance.
2. The model of an electric component using LCR parameterization is only an effective description for a complex system which can involve also a generation of plasma phase meaning that the coil is not anymore a closed system since charge carriers leak out. It can happen that the magnitude of the phase difference between current and voltage can become larger than  $\pi/2$ .

### Could remote metabolism work for a Tesla coil acting as a capacitor?

The best manner to demonstrate new phenomenon is to generate it artificially. The previous considerations suggest a possible model for how artificial remote metabolism could be realized in terms of something akin to Tesla coil or magnifying transmitter. Bifilar coil ([http://en.wikipedia.org/wiki/Bifilar\\_coil](http://en.wikipedia.org/wiki/Bifilar_coil)) looks like a promising realization of the coil. There are two options corresponding to the possibilities that the currents in the two components of bifilar coil runs in same or opposite directions. In the latter case, the magnetic field generated by the bifilar coil is very weak and coil acts as capacitor.

1. The secondary in Tesla transmitter acts as both inductance and capacitor. The alternating magnetic field associated with the inductance implies magnetic motor activity for topologically quantized magnetic field, and would make it ideal for developing reconnections with the flux tubes of a larger magnetic body providing via remote metabolism the energy and charge to the secondary acting as a capacitor. It is however essential that the strength of the magnetic field at the flux tube is same as that at the larger magnetic body.
2. The model for cold electricity in terms of dark matter suggests that when the voltage along bifilar coil exceeds critical voltage  $V_{cr}$ , it becomes charged and together with Earth forms a capacitor in voltage  $V_J$  defining Josephson potential for the resulting Josephson junction. A good guess for  $V_{cr}$  is  $eV_{cr} = m_e = .5$  MeV.  $V_J$  is rather high and above the critical voltage  $V_d$  for dielectric breakdown. The generation of charge is due to the "traffic jam" for electrons making also possible the phase transition to dark matter. If this picture is correct, Josephson currents do not appear below  $V_{cr}$  and coil or bifilar coil acting as a capacitor is necessary for the the remote metabolism. The constant part of voltage would make the resulting coil/capacitor hybrid analogous to cell membrane. Also DNA double strand could serve as a similar coil/capacitor-like system: now the traffic jam would correspond to the presence of two electron charges per nucleotide due to the attached phosphates expected to relate closely to metabolism and therefore also remote metabolism.
3. For general coils or bifilars for which the currents are parallel the transition to the dark phase would have measurable circuit theoretic correlates. The traffic jam for electrons would generate dark supra phase propagating along dark magnetic flux tubes. Only very weak ordinary magnetic fields are generated. Therefore the inductance in visible sector is very small and system becomes capacitive. The resonance like transitions from a situation in which the phase of the frequency dependent impedance  $Z = R + i(\omega L - 1/(\omega C))$  ( $R, L$  and  $C$  depend on  $\omega$ ) characterizing physics in the visible sector suddenly changes sign and changes from almost  $\pi/2$  to  $-\pi/2$  could be seen as a measurable signature for the generation of dark Cooper pairs (cold currents of Tesla). Dark phases could appear in finite frequency ranges.
4. The interpretation in terms of the credit card mechanism would suggest that the resulting system is able to store energy at its magnetic body and also load it when needed - even from foreign magnetic body. The loading should be a spontaneous process and understandable in terms of the need to survive reducing to Negentropy Maximization Principle [K44]. Hence the system would in this respect act like a living system. Loading means the sending of negative energy signals to the magnetic body as phase conjugate Josephson photons. This involves also the change of the arrow of the imbedding space geometric time in the time scale defined by single cycle of the process. Macroscopic quantum phenomenon would therefore be in question.

### 6.5.6 Tesla's findings from a new viewpoint

Tesla's experiments with induction coils generated strong AC electric fields inducing charge separations leading to di-electric breakdowns through the surrounding air, kind of mini-lightnings. I have proposed that both real and mini-lightnings involve large  $h_{eff}$  phase making possible high temperature super-conductivity along pairs of magnetic flux tubes forming possible U-shaped loops which reconnect with the target: this provides a model for high  $T_c$  superconductivity. There is evidence that electrons in lightnings travel to the surface of Earth with very low dissipation and also gamma rays are observed. These facts are not consistent with the standard physics models for lightnings since the dissipation in atmosphere does not allow these phenomena.

A concrete model for the Cooper pairs would be as pairs of electrons at neighboring tubes with magnetic fluxes which have same (opposite) directions. The presence of magnetic fields concentrated at flux tubes favors formation of  $S = 1, L = 1$  Cooper pairs ( $S = 0, L = 2$ ) Cooper pairs [K14, K66, K55].

To proceed one should try to find a more concrete model for the generation of large value of  $h_{eff}$  making possible super-conductivity.

### How to understand the value of $h_{eff}$ ?

The basis problem is to understand how  $h_{eff}$  depends on the parameters characterizing the situation at the magnetic flux tube connecting two systems. I have considered several mechanisms for the generation of large  $h_{eff}$  phase.

1. The model for  $h_{eff}$  in systems involving charge separation stimulated by AC current was based on the identification of Josephson frequency with the frequency of AC current:  $f_J = E_J/h_{eff} = f_{AC}$  predicting  $h_{eff}/h = E_J/hf_{AC}$  [K90].

The findings of Pollack and the difficulties to understand metabolic energy quantum of nominal value .5 eV in the simplest model for cell membrane as Josephson junction as Josephson energy for Cooper pair equal to  $ZeV = 10-10.6$  mV inspired the assumption that cyclotron energies at flux tubes traversing cell membrane can be different at the two sides of the cell membrane [K22, K55]. This would lead to a generalization of the notion of Josephson junction associated with the transmembrane protein and generalizes  $f_J = f_{AC}$  to  $\Delta f_c + f_J = f_{AC}$  predicting  $h_{eff}/h = E_J/(h(\Delta f_c - f_{AC}))$  so that  $h_{eff}/h$  would get arbitrarily large values near resonance  $f_{AC} = f_c$ . Note that correct sign requires  $\Delta f_c - f_{AC} > 0$ .

2. The conjecture  $h_{eff} = h_{gr} = GMm/v_0$  could make sense at microscopic level for particle-Earth pair and would predict a universal spectrum of bio-photons if identified as resulting from the decays of dark cyclotron photons to bio-photons. The first guess for the parameter  $v_0$  would be as a rotational velocity associated with the two systems such as Earth and electron rotating with it. In case of planetary orbits  $v = v_0$  is not consistent with

$$\frac{v}{c} = \frac{\sqrt{\frac{v_0}{c}}}{4\pi n}$$

following from Bohr rules in  $1/r$  potential ( $n$  denotes the principal quantum number).

3.  $h_{eff} = h_{em} = Z_1 Z_2 e^2 / v_0$  hypothesis is a natural looking generalization in systems involve large charge separations, say the exclusion zones discovered by Pollack providing a model for prebiotic life forms. The philosophy would be that when the coupling strength between systems becomes so large that perturbation theory fails, the value of  $h_{eff}$  increases and makes perturbation theory is in powers of  $1/h_{eff}$  possible again. At space-time level this means emergence of non-determinism so that 3-surfaces at the future and past boundaries of causal diamond are connected by n-branched space-time surface for which branches fuse at the two ends. Dark matter would be Nature's manner to define what non-perturbative phases are. The strong hypothesis  $h_{eff} = h_{em} = h_{gr}$  might make possible reconnection between em and gravimagnetic flux tubes and ATP synthase is here a candidate system.
4. Rotating magnetic systems with high negative charge are also good candidates for generating large  $h_{eff}$  at the magnetic flux tubes possibly contain dark proton sequences identifiable as dark nuclei. I have also proposed that a system subject to constant torque allowing description in terms of potential function which is multivalued as function of the angle coordinate  $\phi$  leads rather naturally to generation of large  $h_{eff}$  [K35] when one requires internal consistency.

### Could dark electrons or protons at magnetic flux tubes serve as current carriers?

There are clearly many options for  $h_{eff}$  to choose if one wants to model Tesla's findings. Some options are characterized by AC frequency and some options by rotation velocity. The electrons in the secondary Tesla coil were believed to get stuck which one could take to mean that ohmic AC current does not flow anymore. If this really occurs electrons do not carry any current and high negative local charge density is generated.

One can consider several mechanisms for the super-conductivity.

1. Some fraction of electrons flows as dark Cooper pairs along magnetic flux tubes. The members of the Cooper pair could reside at the flux tubes of the approximately dipolar magnetic field located in the interior of the coil and and at the exterior of the coil near its surface and carrying magnetic fluxes in opposite direction. The interaction of spin with magnetic field

usually tends to disrupt the Cooper pair but not it stabilizes it. One can consider several guesses for the value of  $h_{eff}$  since AC current is in question.

2. If the notion of exclusion zone makes sense also for more general systems than water, one might guess that perhaps dark magnetic flux tubes carrying dark protonic currents along them are generated. The objection is that water is not present now and this option works only if there is source of protons. This option does not look very promising now.

Second challenge is to identify candidates for the supra currents and Josephson currents possibly appearing in the system.

1. Mini-lightnings carrying supra currents could form when U-shaped flux tubes from the secondary coil reconnect with "ground" and dark supra current flows along them. The formula  $h_{eff} = Z_1 Z_2 e^2 / v_0$  or even  $h_{gr} = M_E m(pair) / v_0$ ,  $v_0$  rotational velocity of Earth, suggests itself now.  $Z_2$  could be the charge  $2e$  of the Cooper pair and  $Z_1$  could be assigned with ground as charge reservoir.
2. One can also consider Josephson currents flowing along flux tube pairs associated with the time-dependent dipole magnetic field accompanying the coil. They would replace the Ohmic AC currents when electrons are "stuck". Josephson frequency would co-incide with AC frequency.

In the case of Josephson current the problem seems to be that the voltage defining Josephson frequency varies periodically as also the magnetic field for AC current. The sticking of Ohmic charge is however expected to destroy AC current so that one would obtain static voltage if ohmic DC current runs through the coil. Thus DC current seems to be necessary.

Static magnetic fields are also necessary for high  $T_c$  super-conductivity. They are achieved if the AC component of the Ohmic current becomes small or vanishing. In Maxwell's ED also also a small DC current present unless the coil contains ferromagnet. In TGD Universe it is also possible that a magnetic field with flux tubes carrying monopole flux requiring no DC current is generated. This kind of monopole magnetic fields could be responsible for the magnetic fields encountered in cosmology and astrophysics (the observed fields are 11 orders of magnitude stronger than the predicted) and could also appear in superconductors and even in ferromagnets.

In this situation the formula  $h_{eff}/h = E_J/hf_{AC}$  would state that the coil acts as a generalized Josephson junction with AC current replaced with Josephson current with  $f_J = E_J/h_{eff} = f_{AC}$ . The formula  $h_{eff}/h = E_J/(h(\Delta f_c - f_{AC}))$  would require that the magnetic field strengths at the ends of coil are different so that also the cyclotron frequencies are different. AC frequency would be equal to the generalized Josephson frequency:  $f_{AC} = \Delta f_c - E_J/h_{eff}$ . In this case one can consider even the possibility that there is no DC current so that one has  $f_{AC} = \Delta f_c$ . This fixes the increment  $\Delta B$  for the magnetic field.





## Chapter 7

# Summary of TGD Inspired Ideas about Free Energy

### 7.1 Introduction

The study of free energy phenomena has evolved to the level at which commercial applications are seriously developed despite the refusal of main stream science to admit the reality of these phenomena. TGD predicts numerous new physics phenomena. These might explain the claimed free energy phenomena such as over unity energy production without identifiable energy source in electrolysis of water, the strange properties of Brown's gas resulting in this process and the claimed cold fusion associated with electrolysis and also the energy production in sonoluminescence claimed to be due to cold fusion reactions. Second class of strange phenomena relate to rotating magnetic systems with Yildiz magnetic motor being the most dramatic example in this respect.

The first sections represent a summary about TGD views concerning cold fusion and related topics: the material comes from three chapters of the online book "p-Adic length scale hypothesis and dark matter hierarchy" [K46]. The summary demonstrates the evolution of ideas occurred during roughly two decades and thus reflects also the evolution of TGD.

The input from the chapters [K71] and [L3] represents the development of what I have christened nuclear string model. This model relies on the fractally natural assumption that atomic nuclei are analogous to proteins in the sense that they correspond to highly folded string like objects (possibly several of them) consisting of sequences of nucleons connected by color bonds having quark and antiquark at their ends. If the color bonds are neutral one obtains the counterparts of ordinary nuclei. The input from chapter [K23] includes discussion of Rossi's reactor and the reported selection rules and section about sonoluminescence.

Color bonds can also have charge  $\pm 1$  corresponding to  $u\bar{d}$  and  $\bar{d}u$  type quark pairs. This predicts large number of exotic nuclei. The guess for the energy scale of the exotic excitations of ordinary nuclei is around keV from an explanation for the finding that X rays from Sun induces effective variation in the rates of nuclear reaction rates: the variation would be explained in terms of excitations of creating exotic nuclei which cannot be distinguished from ordinary nuclei chemically.

Exotic nuclei represent new nuclear physics and this raises the question about their relevance for low energy nuclear reactions.

1. Could cold fusion involve a mechanism generating exotic nuclei by generating charged color bonds and in this manner help to get rid of Coulomb wall? Dark variant of weak interactions are necessary to achieve this since otherwise the rates are extremely low. Since W boson is effectively massless below the scaled up weak length scale, which should be of the order of atomic length scale, weak interaction rate would be enhanced so that they are of same order of magnitude as for electromagnetic interactions. Clearly rather large value of  $h_{eff} \sim 10^7 h$  is required.

For instance, could the exchange of a dark variant of  $W^+$  boson between incoming proton and target nucleus (say D) transform dark proton to dark neutron and increase the charge of target nucleus by one unit (say transforming it to pseudo Helium isotope with charge 2).

This would eliminate Coulomb wall and might relate to the fact that neutrons and gamma rays are not emitted in H-D cold fusion. Dark  $W^+$  could also be exchanged between electron and p inside D and neutralize D to effective di-neutron state.

2. Could the nuclei resulting from the low energy nuclear reactions be also exotic? This would help to explain the non-standard selection rules.

Second mechanism relies on darkness alone. If incoming proton and its quarks are dark having Compton size scale of order atomic size, the target nucleus would be much smaller than quarks and one can imagine target nucleus enters the Coulomb field of negatively charged n-quark so that Coulomb wall changes sign and the reaction can proceed.

In this chapter I represent first earlier ideas and models related to free energy and after than some new material is discussed.

1. The topics from [K71] represents a vision about cold fusion based on Trojan horse mechanism allowing to circumvent Coulomb wall. All mechanisms discussed later are variants of this mechanisms.
2. The topics from [L3] contains a lot of material. For instance, included are a discussion of findings of Kanarev and Mizuno related to electrolysis of water, the  $H_{1.5}O$  anomaly of water suggesting that water contains dark component, a discussion of a model of electrolysis and plasma-electrolysis, and a short discussion of the biological transmutations. The possibility of cold fusion in interstellar space could produce heavy elements so that solar interior would not be the only place where they are produced during the cosmic evolution. For instance, the well-known Lithium anomaly of cosmology could be explained in terms of cold fusion. Besides producing energy cold fusion could also make possible both spontaneous and artificially induced generation of metals and other heavier elements from light ones.

The basic new physics element in TGD based model of electrolysis is the phase transition increasing the value of  $h_{eff}$  for the space-time sheet at which water is topologically condensed and inducing "electric expansion of water". This would occur in strong local electric fields inducing di-electric breakdown. The reversal of this phase transition would explain the observed spontaneous implosion. The third phase transition would reduce  $h_{eff}$  but increase p-adic prime  $p$  in such a manner that volume remains unaffected. This phase transition liberates zero point kinetic energy (ZPKE). This energy could be behind several anomalies related to the electrolysis of water and also provide basic mechanism of the liberation of metabolic energy in living matter. The reverse transition could be induced by irradiation by light and could take place routinely in photosynthesis and be part of ADP-ATP transition.

Strong local electric fields would induce the  $h_{eff}$  increasing phase transitions and these fields indeed are present being associated with rough electrode surfaces. Strong electric fields appear also in cell membranes and in plasmoids proposed to define prebiotic life forms in TGD Universe. Lightnings and ball lightnings would be examples of plasmoids generating their metabolic energy by the proposed phase transition.

3. The input from [K23] includes discussion of Rossi's reactor and the reported selection rules and section about sonoluminescence with slight updatings. Also a model for the hydrino atom of Rossi based on so called q-Laguerre equation is discussed.

In last sections some new ideas and devices related to free energy are discussed. The ZPE approach is compared with the TGD approach identifying dark matter as a hierarchy of phases of ordinary matter characterized by non-standard value of Planck constant  $h_{eff} = nh$ . The general ideas behind anomalous hydrolysis of water are introduced, and a possible model for Brown's gas explaining its anomalous properties is formulated. This inspires a vision about how metabolism in living matter could utilize the mechanisms explaining the behavior of Brown's gas. Also cold fusion and sonoluminescence are briefly discussed with references to a more extensive summary about TGD inspired vision about these phenomena. The last section is devoted to Yildiz magnetic motor and relates closely to the model for rotating magnetic systems [K4] devices to explain the claims of Godin and Roschin [H49].

The material represents a development of ideas and TGD itself. Experimental data allow to consider several options so that a complete internal consistency of the ideas discussed is too much to hope for.

The appendix of the book gives a summary about basic concepts of TGD with illustrations. There are concept maps about topics related to the contents of the chapter prepared using CMAP realized as html files. Links to all CMAP files can be found at <http://www.tgdtheory.fi/cmaphtml.html> [L8]. Pdf representation of same files serving as a kind of glossary can be found at <http://www.tgdtheory.fi/tgdglossary.pdf> [L9]. The topics relevant to this chapter are given by the following list.

- Magnetic body [L19]
- Hierarchy of Planck constants [L17]
- Pollack's observations [L21]

## 7.2 Cold fusion and Trojan horse mechanism

The model for cold fusion has developed gradually as the understanding of quantum TGD and many-sheeted space-time has developed. Trojan horse mechanism has served as the connecting thread between various models. The last step of progress relates to the new vision about nuclear physics but it is still impossible to fix the model completely unless one poses the condition of minimality and the requirement that single mechanism is behind various anomalies.

### 7.2.1 Exotic quarks and charged color bonds as a common denominator of anomalous phenomena

There should exist a common denominator for anomalous behavior of water, cold fusion, the findings of Ditmire suggesting cold fusion, sono-fusion, exotic chemistries, strange properties of living matter including chiral selection, and also phenomena like low compressibility of condensed matter which standard physicist would not be worried about.

It seems that compression inducing the generation of charged color bonds between nucleons and leading to a formation of super-nuclei with atomic distances between building blocks might be the sought for common denominator. For super nuclei the repulsive weak interactions between exotic quark and anti-quark belonging to the two bonded nuclei would compensate the attractive color force so that a stable configuration of atomic size would result. Note that the weak coupling strength would be actually strong by the general criterion for transition to the large  $\hbar$  phase.

The charging of color bonds would occur via  $W$  boson exchange between exotic and valence quarks with exotic  $W$  boson transforming to ordinary  $W$  via mixing.

The alternative option is a phase transition of nuclei transforming  $k = 113$  em space-time sheets of valence quarks to em dark space-time sheets with a large value of  $\hbar$  suggested for heavier nuclei by the general criteria. This phase transition could be avoided if the criticality forces surplus protons to transfer the electromagnetic charge of valence quarks to color bonds so that the situation reduces to the first option. In this picture standard nuclear physics would remain almost untouched and nothing new except exotic quarks and charged color bonds is introduced.

The following examples suggest that this general picture indeed might unify a large class of phenomena.

1. The super-nuclei formed by the dark protons of water would be a basic example about this phenomenon. The occurrence of the process is plausible if also nucleons possess or can generate closed loops with exotic quark and anti-quark at the ends of the loop belonging to the same nucleon. The fact that these protons are dark with respect to electromagnetic interactions suggests that the charge of protons is transferred to the color bonds so that the outcome is a nuclear string formed from neutrons connected by positively charged color bonds. Darkness with respect to weak interactions suggests that valence quarks are doubly dark. This would mean that the p-adic length scale of color bonds would correspond to  $k_{eff} = 107 + 2 \times 22 = 151$  for  $\hbar_s = n^2 \hbar / v_0^2$ ,  $n = 1$ . This corresponds to the thickness

of cell membrane so that the structure of water would contain information about the basic biological length scale.

2. In condensed matter the super-nuclei would form at some critical pressure when weakly charged color bonds between neighboring nuclei become possible and compensate the attractive color force. This would explain the low compressibility of condensed matter.
3. Bio-polymers in vivo might correspond to super-nuclei connected by charged color bonds whose weak charges would explain the large parity breaking involve with chiral selection. Hydrogen bond might be a basic example of a charged color bond. It could be that the value of integer  $n$  in  $\hbar_s = n\hbar/v_0$  is  $n = 3$  in living matter and  $n = 1$  in ordinary condensed matter. Trojan horse mechanism might work also at the level of chemistry making possible to circumvent electronic Coulomb wall and might be an essential characteristic of the catalytic action. Note that Pd is also a powerful catalyst.  $n = 1$  might however distinguish it from bio-catalysts. In separate context I have dubbed this mechanism as 'Houdini effect'.

The reported occurrence of nuclear transmutations [C30, C41] such as  $^{23}\text{Na} + ^{16}\text{O} \rightarrow ^{39}\text{K}$  in living matter allowing growing cells to regenerate elements K, Mg, Ca, or Fe, could be understood as fusion of neighboring nuclei connected by charged color bond which becomes neutral by  $W$  emission so that collapse to single nucleus results in absence of the repulsive weak force. Perhaps it is someday possible to produce metabolic energy by bio-fusion or perhaps Nature has already discovered the trick!

4. In cold fusion the nuclei of target D and Pd would combine to form super-nuclei connected by charged color bonds. This would explain why the heavy loading of Pd nuclei with D (for a review of loading process see [C39] ) does not generate enormous pressures. Cold fusion would occur in some critical interval of loadings allowing ordinary and exotic nuclei to transform to each other. The transfer of the em charge of D to the color bond connecting D and Pd would make D effectively nn state. Together with the fact that the color bond would have length of order atomic radius would mean that the Coulomb wall of Pd and D is not felt by beam nuclei and Trojan horse mechanism would become possible. The prediction is that Coulomb wall disappears only only when deuterium or tritium target is used. If nuclei can transform to dark em phase cold fusion could occur for arbitrary target nuclei. That it is observed only for D and possibly H does not support this option.

If valence quarks are doubly dark, their magnetic bodies have size of order  $L(151) = 10$  nm, which is also the size scale of the nano-scaled Pd particles, color force would become long ranged. In sono-luminescence and son-fusion and also in nuclear transmutations similar formation of super-nuclei would occur and the collapse of super-nucleus to single nucleus could occur by the proposed mechanism.

5. In the experiments of Ditmire *et al* laser pulse induces very dense phase of Xenon atoms having  $Z = 54$  which is heated to energies in which electron energies extend to MeV region and expands rapidly.  $Z = 54$  means that Xe satisfies the most stringent condition of criticality for the transition to electromagnetic large  $\hbar$  phase. This transition does not occur if protons feed the surplus em charge to the color bonds so that Xe nuclei also weakly charged. Assume that some fraction of Xe is in this kind of phase. The compression of Xe gas by laser pulse compresses Xe super-nuclei. If the connecting charged color bonds emit their em and weak charge by emission of  $W$  boson the super-nuclei collapse to single nucleus and nuclear fusion reactions become possible. The repulsive weak force becoming manifest in the compression generates brehmstrahlung heating the system and induces a violent explosion much like in sono-fusion.

In the sequel the experiments Ditmire *et al* and cold fusion are discussed in detail using this model.

### 7.2.2 The experiments of Ditmire *et al*

An important stimulation in the development of the model for cold fusion came from the observations of Ditmire *et al* [C21] published in Nature. The discovery was that the energy spectrum of electrons in ionic explosions induced by the laser heating of ionic clusters extends up to energies

of order MeV (rather  $10^2$  eV(!)): this suggests strongly a mechanism making strong interactions possible.

In the experimental arrangement of Ditmire *et al* clusters of Xenon atoms are hit by ultrashort (150 fsec), high-intensity ( $2 \times 10^{16}$  W/cm<sup>2</sup>) laser pulses [C21]. This leads to superheating and production of high energy ions in the explosions of the superheated clusters. The highest ion energies are by 4 orders of magnitude larger than expected and of order MeV, the typical energy scale of nuclear strong interaction. The average ion energy is  $45 \pm 5$  keV for cluster size of 6.5 nm and decreases slowly with the size of the cluster. No hot ions are produced for small clusters containing less than  $\sim 100$  Xe atoms. It is not yet understood why the clusters explode so much more violently than molecules (producing 1 MeV ions as opposed to 100 eV ions) and small clusters. Another striking feature of the laser-cluster interaction is ionization to very high charge states, much higher than in the ionization, which can be produced by simple field ionization.

Consider first a more detailed model of the superheating as it is described in [C21].

*In an intensely irradiated cluster, optically and collisionally ionized electrons undergo rapid collisional heating for the short time ( $< ps$ ) before the cluster disassembles in the laser field. Our recent studies of the electron energy spectra produced by the high intensity irradiation of large Xe clusters with 150 fs laser pulse indicate that collisional heating within the cluster can produce electrons with energy up to 3 keV, an energy much higher than that typical of solid target plasmas.*

*A sharp peak in the measured electron energy spectrum suggested that the cluster micro-plasma exhibited a resonance in the heating by laser pulse similar to the giant resonance seen in metallic clusters. A small amount of cluster expansion during the laser pulse lowers the electron density to bring the near-infrared laser light into resonance with the free-electron plasma frequency in the cluster. This resonance greatly increases the laser electric field density within the cluster, and the laser absorption rate is enhanced, rapidly heating the electrons on a very fast ( $< 10$  fs) time scale to a highly non-equilibrium superheated state with mean energies of many keV. Charge separation of hot electrons inevitably leads to a very fast expansion of the cluster ions. This process is fundamentally different from low-intensity photo-fragmentation of cluster and far more energetic than the Coulomb explosion of small molecules.*

Authors believe (rather naturally!) that the production of hot ions is made possible by the high ion-temperatures produced by the not yet properly understood heating mechanism and suggest that this mechanism might make even table-top fusion possible.

In TGD framework the proposed general vision suggests following picture.

1. Laser pulse induces a compression of clusters of Xe atoms already containing super-nuclei with charged color bonds so that repulsive weak interaction compensated by color force in equilibrium situation becomes manifest and induces the expansion of the system much like the expansion of the bubble in sono-luminescence. The resulting brehmstrahlung heats the system.
2. The critical cluster size 6.5 nm could correspond to the p-adic length length scale  $L(k_{eff} = 151) = 10$  nm for doubly dark valence quarks with  $n = 1$ .
3. The nuclear fusions resulting when color bonds between nuclei become neutral and induce collapse to single nucleus. Anomalously high charge states could be a byproduct of violent and very rapid fusions of neighboring color bonded Xe nuclei tearing Xe nuclei and outer electrons apart. These fusions would generate quantum coherent dark gamma ray beams transforming to ordinary gamma rays by de-coherence transition reducing the wavelength of gamma rays by a factor of  $2^{-11}$  for  $\hbar_s = \hbar/v_0$ . It is also possible that dark gamma rays are absorbed by Pd super-nuclei. The wavelengths of dark gamma rays with energy of MeV would of order 2 nanometers in this case so that a coherent heating would happen in rather large volume.

### 7.2.3 Brief summary of cold fusion

In the following history and signatures of cold fusion are briefly summarized.

### History of cold fusion

The first claim for cold fusion [C32] dates back to March 23, 1989, when Pons and Fleischmann announced that nuclear fusion, producing usable amounts of heat, could be induced to take place on a table-top by electrolyzing heavy water and using electrodes made of Pd and platinum. Various laboratories all-over the world tried to reproduce the experiments. The poor reproducibility and the absence of the typical side products of nuclear fusion (gamma rays and neutrons) led soon to the conclusion (represented in the dramatic session of American Physical Society May 1, 1989) that nuclear fusion cannot explain the heat production. Main stream scientists made final conclusions about the subject of 'cold fusion' and cold fusion people became a pariah class of the scientific community.

The work with cold fusion however continued and gradually situation has changed. It became clear that nuclear reaction products, mainly  $^4\text{He}$ , are present. Gradually also the reasons for the poor reproducibility of the experiments became better understood. A representative example about the change of the attitudes is the article of Schwinger [C36] in which cold fusion is taken seriously. The article also demonstrates that the counter arguments of hot fusion people are based on the implicit assumption that hot fusion theory describes cold fusion despite the fact that the physical situations are radically different.

The development on the experimental side has been based on techniques involving the use of catalysis, nanotechnology, electrolysis, glow discharge and ultrasonic cavitation. There are now public demonstrations of cold fusion reactors, whose output energy far exceeds input energy and commercial applications are under intensive development.

Rather remarkably, also the production of heavier elements has been detected [C35] and this makes the explanation of the effect even more difficult in standard physics context and definitely excludes the explanations claiming that some chemical process is the source of the excess heat. The possibility of nuclear transmutation also suggests the possibility to transform ordinary nuclear wastes into non-radioactive nuclei and the first method achieving this has already been reported [C11]. There are claims [C30, C41] that cold fusion indeed occurs in bio-systems.

There is also some evidence for high temperature super conductivity associated with deuterium loaded palladium [C35]. Good representations about the subject of cold fusion and references to the experimental work can be found at various cold fusion web-sites [C3, C2]. Also the articles of J. Rothwell [C35] and the excellent review article of E. Storms [C38] are recommended.

It has become clear that cold fusion differs from hot fusion in several respects: gamma rays are not produced and the flux of neutrons is much lower than predicted by standard nuclear physics (these features are very well-come from the point of view of the technological applications). Together with the fact that Coulomb wall does not allow the occurrence of cold fusion at all in the standard physics context, this forces the conclusion that new physics must be involved.

It seems that TGD indeed could provide this new physics. The key elements of the model to be discussed are Trojan horse mechanism and coherent photon exchange action of D nuclei with Cooper pairs of the exotic super conductor formed by the D-loaded cathode material (say Palladium).

In the sequel the consideration is restricted to the case of Pd cathode: the model generalizes trivially to the case of a more general cathode material.

### Signatures of cold fusion

In the following the consideration is restricted to cold fusion in which two deuterium nuclei react strongly since this is the basic reaction type studied.

In hot fusion there are three reaction types:

- 1)  $D + D \rightarrow ^4\text{He} + \gamma$  ( $23.8\text{MeV}$ )
- 2)  $D + D \rightarrow ^3\text{He} + n$
- 3)  $D + D \rightarrow ^3\text{H} + p$ .

The rate for the process 1) predicted by standard nuclear physics is more than  $10^{-3}$  times lower than for the processes 2) and 3) [C40]. The reason is that the emission of the gamma ray involves the relatively weak electromagnetic interaction whereas the latter two processes are strong.

The most obvious objection against cold fusion is that the Coulomb wall between the nuclei makes the mentioned processes extremely improbable at room temperature. Of course, this alone

implies that one should not apply the rules of hot fusion to cold fusion. Cold fusion indeed differs from hot fusion in several other aspects.

1. No gamma rays are seen.
2. The flux of energetic neutrons is much lower than expected on basis of the heat production rate an by interpolating hot fusion physics to the recent case.

These signatures can also be (and have been!) used to claim that no real fusion process occurs. It has however become clear that the isotopes of Helium and also some tritium accumulate to the Pd target during the reaction and already now prototype reactors for which the output energy exceeds input energy have been built and commercial applications are under development. Therefore the situation has turned around. The rules of standard physics do not apply so that some new nuclear physics must be involved and it has become an exciting intellectual challenge to understand what is happening. A representative example of this attitude and an enjoyable analysis of the counter arguments against fold fusion is provided by the article 'Energy transfer in cold fusion and sono-luminescence' of Julian Schwinger [C36] . This article should be contrasted with the ultra-skeptical article 'ESP and Cold Fusion: parallels in pseudoscience' of V. J. [C37] [C37] .

Cold fusion has also other features, which serve as valuable constraints for the model building.

1. Cold fusion is not a bulk phenomenon. It seems that fusion occurs most effectively in nano-particles of Pd and the development of the required nano-technology has made possible to produce fusion energy in controlled manner. Concerning applications this is a good news since there is no fear that the process could run out of control.
2. The ratio  $x$  of D atoms to Pd atoms in Pd particle must lie the critical range [.85, .90] for the production of  ${}^4\text{He}$  to occur [D19] . This explains the poor repeatability of the earlier experiments and also the fact that fusion occurred sporadically.
3. Also the transmutations of Pd nuclei are observed [C35] .

Below a list of questions that any theory of cold fusion should be able to answer.

1. Why cold fusion is not a bulk phenomenon?
2. Why cold fusion of the light nuclei seems to occur only above the critical value  $x \simeq .85$  of D concentration?
3. How fusing nuclei are able to effectively circumvent the Coulomb wall?
4. How the energy is transferred from nuclear degrees of freedom to much longer condensed matter degrees of freedom?
5. Why gamma rays are not produced, why the flux of high energy neutrons is so low and why the production of  ${}^4\text{He}$  dominates (also some tritium is produced)?
6. How nuclear transmutations are possible?

#### 7.2.4 TGD inspired model of cold fusion

The model to be discussed is based on Trojan horse mechanism and explains elegantly all those aspects of cold fusion which are in conflict with standard nuclear physics. The reaction mechanism explains also the sensitivity of the occurrence of cold fusion to small external perturbations.



### Model for D-loaded Pd nano-particle

It seems that cold fusion is a critical phenomenon. The average  $D/Pd$  ratio must be in the interval (.85, .90). The current must be over-critical and must flow a time longer than a critical time. The effect occurs in a small fraction of samples. Deuterium at the surface of the cathode is found to be important and activity tends to concentrate in patches. The generation of fractures leads to the loss of the anomalous energy production. Even the shaking of the sample can have the same effect. The addition of even a small amount of  $H_2O$  to the electrolyte (protons to the cathode) stops the anomalous energy production.

All these findings support the catastrophe theoretic picture according to which the decomposition into patches corresponds to criticality allowing the presence of ordinary and exotic phase whose transformation to the ordinary phases makes possible cold fusion reactions. The added ordinary protons and fractures could serve as a seed for a phase transition leading to a region where only single phase is possible.

In TGD framework Pd nano-particles correspond to space-time sheets of size of order  $10^{-9} - 10^{-8}$  m and fusion is restricted inside these structures. Cold fusion can be regarded as a fusion of incoming ordinary D with target D attached to the surface of Pd rather than between two free D:s as suggested by the standard nuclear physics wisdom. Thus cold fusion could be regarded as 'burning' of D associated with a finite space-time sheets so that cold fusion is not a bulk phenomenon and is very sensitive to the in-homogenities of the Pd particle. Note that this in principle makes the control of cold fusion easier.

The critical loading fraction varies in the range .85 – .90. This value is so large that enormous pressures would be generated unless the deuterium nuclei lose their translational degrees of freedom by forming some kind of bound states with Pd nuclei. The guess is that the bound states correspond to the formation of super-nuclei with em and weakly charged color bonds connecting Pd and D nuclei.  $k = 113$  dark weak force, which is actually strong by the criticality condition, compensates the color force between the exotic quarks. This makes D nuclei effectively nn nuclei so that Coulomb wall does not produce difficulties.

The challenge is to understand the origin of the criticality condition for super-nucleus. The question is why the number of D nuclei per Pd nuclei varies in so narrow range for the phase transition leading to the formation of super-nuclei to occur. Catastrophe theoretic thinking suggests that a cusp catastrophe typical for phase transitions is in question. In the critical range there are two phases, exotic and ordinary phase, which can easily transform to each other. Criticality is essential for the cold fusion reactions to occur since initial state involves exotic D+Pd complex and final state involves ordinary nuclei.

The ratio  $x$  would correspond to the variable which varies in a direction transversal to cusp and whose variation therefore leads to a catastrophic jump inducing the phase transition or its reverse.  $x$  would be a pressure type variable which plays similar role also in phase transitions like liquid-gas phase transition. The critical range for  $x$  would correspond to the critical range of pressure in which liquid and gas are in equilibrium.

Second variable varies along the cusp so that the transition is possible above certain critical value. This variable presumably relates to the energetics of the transition so that transition would liberate energy above critical value of the parameter. Temperature is a natural candidate for this variable. Catastrophe theoretic model implies that for a given value  $x$  in catastrophe region both ordinary phase and exotic phase are possible. In these regions cold fusion can occur. In regions where the system is outside the catastrophe region so that system is stably in either phase, cold fusion cannot occur. This explains why Pd contains only patches where cold fusion occurs. The control variable, be it local temperature or something else, could be perhaps identified by studying the local conditions guaranteeing the occurrence of cold fusion. It is indeed known that the increase of temperature favors the occurrence of cold fusion.

The behavior variable could distinguish between the two phases and could correspond to the surface density  $n$  of D nuclei bound to Pd nuclei and transformed to fake D. The potential function could be free energy minimized when the system is in constant temperature and the two phases would correspond to local minima of free energy.

### Anomalous reaction kinetics of cold fusion

One can deduce a more detailed model for cold fusion from observations, which are discussed systematically in [C40] and in the references discussed therein.

1. When  $D_2O$  is used as an electrolyte, the process occurs when  $PdD$  acts as a cathode but does not seem to occur when it is used as anode. This suggests that the basic reaction is between the ordinary deuterium  $D = pn$  of electrolyte with the the exotic  $D=nn +$  charged color bond attached to Pd in the cathode.
2. For ordinary nuclei fusions to tritium and  ${}^3He$  occur with approximately identical rates. The first reaction produces neutron and  ${}^3He$  via  $D + D \rightarrow n + {}^3He$ , whereas second reaction produces proton and tritium via  $D + D \rightarrow p + {}^3H$ . The standard nuclear physics prediction is that one neutron per each tritium nucleus should be produced. Tritium can be observed by its beta decay to  ${}^3He$  and the ratio of neutron flux is several orders of magnitude smaller than tritium flux as found for instance by Tadahiko Mizuno and his collaborators (Mizuno describes the experimental process leading to this discovery in his book [C22] ). Hence the reaction producing  ${}^3He$  cannot occur significantly in cold fusion which means a conflict with the basic predictions of the standard nuclear physics.

The explanation is following. If D is fake D ( $nn+$ charged color bond connecting it with Pd), one expects that the production of  ${}^3He$  is hindered since there is no proton directly available. Also in the case that the reaction  $n+color\ bond \rightarrow p$  occurs, one expects that Coulomb wall makes the process slow.

3. The production of  ${}^4He$ , which should not occur practically at all, is reported to dominate and the fraction of tritium is below .1 per cent. The explanation could be that also multiple attachments to target can occur such that D attaches to (D+Pd) by forming a charged color bond. Thus would have  $nnnn$  state with two charged color bonds attached to Pd. This state could split from Pd and transform via exchange of two light weak bosons between exotic and valence quarks to  ${}^4He$  (assuming that dark  $W(113)$  can mix with  $W(89)$ ). It is also possible that the super-nuclear string formed by Pd and D splits and emits  ${}^4He$  as in ordinary alpha decay. Gamma rays need not be generated since the recoil momentum could be transferred to the Pd target like in Mössbauer effect.
4. Also more complex reactions between  $D$  and  $Pd$  and between Pd nuclei can occur. These can lead to the reactions transforming the nuclear charge of  $Pd$  and thus to nuclear transmutations.
5. The mechanism also explains why the cold fusion producing  ${}^3He$  and neutrons does not occur using water instead of heavy water. There are reports about cold fusion also in this case [C38] . If one fourth of protons in water are arranged to nuclear strings consisting of neutrons connected by positively charged color bonds as the TGD based model explaining the anomalies of water suggests [K23] , these strings could attach to fake D and induce cold fusion reactions.
6. The proposed reaction mechanism explains why neutrons are not produced in amounts consistent with the anomalous energy production. The addition of water to the electrolyte however induces neutron bursts. Suppose that one fourth of protons in water forms similar dark phase being transformed to neutrons connected by positively charged color bonds, as assumed in the model of water explaining various anomalies of water [K23] . What comes in mind is that neutrons are generated when a neutron string from  $H_2O$  containing only charged color bonds attaches to  $D+Pd$  ( $nn +$  charged color bond  $+Pd$ ). Neutrons of  $nn$  are connected by a neutral color bond. If charged color bonds between neutrons are energetically more favorable than neutral color bonds,  $nn$  could emit a free neutron in the process so that the outcome would be a neutron string containing only charged color bonds attached to Pd.

### How objections against cold fusion are circumvented?

It has already become clear that the model allows to circumvent the basic reaction kinetic arguments against cold fusion [C40] .

1. Coulomb wall makes nuclear fusions impossible.
2.  ${}^3\text{He}$  and  ${}^3\text{H}$  should be produced in equal amounts. The fraction of  ${}^4\text{He}$  should be smaller than  $10^{-3}$ .
3. The claimed nuclear transmutation reactions (reported to occur also in living matter [C30] ) should not occur.

Consider next the objections related to energetics.

1. Gamma rays, which should be produced in most nuclear reactions such as  ${}^4\text{He}$  production to guarantee momentum conservation are not observed. The explanation is that the recoil momentum goes to the macroscopic quantum phase defined by the Pd lattice as in Mössbauer effect, and eventually heats the electrolyte system. This provides the mechanism by which the liberated nuclear energy is transferred to the electrolyte difficult to imagine in standard nuclear physics framework.
2. If a nuclear reaction should occur, the immediate release of energy can not be communicated to the lattice in the time available. In the recent case the time scale is however multiplied by the factor  $r = \hbar_s/\hbar$  giving scaling factor  $2^{11}$  so that the situation changes dramatically.

### 7.2.5 Do nuclear reaction rates depend on environment?

Claus Rolfs and his group have found experimental evidence for the dependence of the rates of nuclear reactions on the condensed matter environment [C16] . For instance, the rates for the reactions  ${}^{50}\text{V}(p,n){}^{50}\text{Cr}$  and  ${}^{176}\text{Lu}(p,n)$  are fastest in conductors. The model explaining the findings has been tested for elements covering a large portion of the periodic table.

#### Debye screening of nuclear charge by electrons as an explanation for the findings

The proposed theoretical explanation [C16] is that conduction electrons screen the nuclear charge or equivalently that incoming proton gets additional acceleration in the attractive Coulomb field of electrons so that the effective collision energy increases so that reaction rates below Coulomb wall increase since the thickness of the Coulomb barrier is reduced.

The resulting Debye radius

$$R_D = 69 \sqrt{\frac{T}{n_{eff} \rho_a}} , \quad (7.2.1)$$

where  $\rho_a$  is the density of atoms per cubic meter and  $T$  is measured in Kelvins.  $R_D$  is of order .01 Angstroms for  $T = 373$  K for  $n_{eff} = 1$ ,  $a = 10^{-10}$  m. The theoretical model [C25, C34] predicts that the cross section below Coulomb barrier for  $X(p, n)$  collisions is enhanced by the factor

$$f(E) = \frac{E}{E + U_e} \exp\left(\frac{\pi \eta U_e}{E}\right) . \quad (7.2.2)$$

$E$  is center of mass energy and  $\eta$  so called Sommerfeld parameter and

$$U_e \equiv U_D = 2.09 \times 10^{-11} (Z(Z+1))^{1/2} \times \left(\frac{n_{eff} \rho_a}{T}\right)^{1/2} \text{ eV} \quad (7.2.3)$$

is the screening energy defined as the Coulomb interaction energy of electron cloud responsible for Debye screening and projectile nucleus. The idea is that at  $R_D$  nuclear charge is nearly completely screened so that the energy of projectile is  $E + U_e$  at this radius which means effectively higher collision energy.

The experimental findings from the study of 52 metals support the expression for the screening factor across the periodic table.

1. The linear dependence of  $U_e$  on  $Z$  and  $T^{-1/2}$  dependence on temperature conforms with the prediction. Also the predicted dependence on energy has been tested [C16] .
2. The value of the effective number  $n_{eff}$  of screening electrons deduced from the experimental data is consistent with  $n_{eff}(Hall)$  deduced from quantum Hall effect.

The model suggests that also the decay rates of nuclei, say beta and alpha decay rates, could be affected by electron screening. There is already preliminary evidence for the reduction of beta decay rate of  $^{22}\text{Na}$   $\beta$  decay rate in Pd [C15] , metal which is utilized also in cold fusion experiments. This might have quite far reaching technological implications. For instance, the artificial reduction of half-lives of the radioactive nuclei could allow an effective treatment of radio-active wastes. An interesting question is whether screening effect could explain cold fusion [C40] and sono-fusion [C19] .

### Electron screening and Trojan horse mechanism

These experimental findings allow to quantify the Trojan horse mechanism. The idea is that projectile nucleus enters the region of the target nucleus along a larger space-time sheet and in this manner avoids the Coulomb wall. The nuclear reaction itself occurs conventionally. In conductors the space-time sheet of conduction electrons is a natural candidate for the larger space-time sheet.

At conduction electron space-time sheet there is a constant charged density consisting of  $n_{eff}$  electrons in the atomic volume  $V = 1/n_a$ . This creates harmonic oscillator potential in which incoming proton accelerates towards origin. The interaction energy at radius  $r$  is given by

$$V(r) = \alpha n_{eff} \frac{r^2}{2a^3} , \quad (7.2.4)$$

where  $a$  is atomic radius.

The proton ends up to this space-time sheet by a thermal kick compensating the harmonic oscillator energy. This occurs below with a high probability below radius  $R$  for which the thermal energy  $E = T/2$  of electron corresponds to the energy in the harmonic oscillator potential. This gives the condition

$$R = \sqrt{\frac{Ta}{n_{eff}\alpha}} a . \quad (7.2.5)$$

This condition is exactly of the same form as the condition given by Debye model for electron screening but has a completely different physical interpretation.

Since the proton need not travel through the nuclear Coulomb potential, it effectively gains the energy

$$E_e = Z \frac{\alpha}{R} = \frac{Z\alpha^{3/2}}{a} \sqrt{\frac{n_{eff}}{Ta}} . \quad (7.2.6)$$

which would be otherwise lost in the repulsive nuclear Coulomb potential. Note that the contribution of the thermal energy to  $E_e$  is neglected. The dependence on the parameters involved is exactly the same as in the case of Debye model. For  $T = 373$  K in the  $^{176}\text{Lu}$  experiment and  $n_{eff}(Lu) = 2.2 \pm 1.2$ , and  $a = a_0 = .52 \times 10^{-10}$  m (Bohr radius of hydrogen as estimate for atomic radius), one has  $E_e = 28.0$  keV to be compared with  $U_e = 21 \pm 6$  keV of [C16] ( $a = 10^{-10}$ m corresponds to  $1.24 \times 10^4$  eV and 1 K to  $10^{-4}$  eV). A slightly larger atomic radius allows to achieve consistency. The value of  $\hbar$  does not play any role in this model since the considerations are purely classical.

An interesting question is what the model says about the decay rates of nuclei in conductors. For instance, if the proton from the decaying nucleus can enter directly to the space-time sheet of the conduction electrons, the Coulomb wall corresponds to the Coulomb interaction energy of proton with conduction electrons at atomic radius and is equal to  $\alpha n_{eff}/a$  so that the decay rate should be enhanced.

Trojan horse mechanism realized in this manner does not seem to explain the basic findings about cold fusion. Trojan horse mechanism applied to deuterium projectile and D-Pd target would predict standard nuclear physics. The reported strong suppression of  ${}^3\text{He}$  production with respect to  ${}^3\text{H}$  production however requires non-standard nuclear physics and the model discussed in the previous subsection provides this physics. Both mechanisms could of course be involved.

### 7.3 Cold fusion, plasma electrolysis, biological transmutations, and burning salt water

The article of Kanarev and Mizuno [D29] reports findings supporting the occurrence of cold fusion in NaOH and KOH hydrolysis. The situation is different from standard cold fusion where heavy water  $D_2O$  is used instead of  $H_2O$ .

One can understand the cold fusion reactions reported by Mizuno as nuclear reactions in which part of what I call dark proton string having negatively charged color bonds (essentially a zoomed up variant of ordinary nucleus with large Planck constant) suffers a phase transition to ordinary matter and experiences ordinary strong interactions with the nuclei at the cathode. In the simplest model the final state would contain only ordinary nuclear matter. The generation of plasma in plasma electrolysis can be seen as a process analogous to the positive feedback loop in ordinary nuclear reactions.

Rather encouragingly, the model allows to understand also deuterium cold fusion and leads to a solution of several other anomalies.

1. The so called lithium problem of cosmology (the observed abundance of lithium is by a factor 2.5 lower than predicted by standard cosmology [E13] ) can be resolved if lithium nuclei transform partially to dark lithium nuclei.
2. The so called  $H_{1.5}O$  anomaly of water [D12, D11, D16, D24] can be understood if 1/4 of protons of water forms dark lithium nuclei or heavier dark nuclei formed as sequences of these just as ordinary nuclei are constructed as sequences of  ${}^4\text{He}$  and lighter nuclei in nuclear string model. The results force to consider the possibility that nuclear isotopes unstable as ordinary matter can be stable dark matter.
3. The mysterious behavior burning salt water [D1] can be also understood in the same framework.
4. The model explains the nuclear transmutations observed in Kanarev's plasma electrolysis. Intriguingly, several biologically important ions belong to the reaction products in the case of NaOH electrolysis. This raises the question whether cold nuclear reactions occur in living matter and are responsible for generation of biologically most important ions.

#### 7.3.1 The data

##### Findings of Kanarev

Kanarev has found that the volume of produced  $H_2$  and  $O_2$  gases is much larger than the volume resulting in the electrolysis of the water used in the process. If one knows the values of  $p$  and  $T$  one can estimate the volumes of  $H_2$  and  $O_2$  using the equation of state  $V = nT/p$  of ideal gas. This gives

$$V(H_2; p, T) = \frac{A(H_2)}{A(H_2O)} \times \frac{M(H_2O)}{m_p} = \frac{1}{9} \frac{M(H_2O)}{m_p} \times \frac{T}{p} .$$

Here  $M(H_2O)$  is the total mass of the water (.272 kg for KOH and .445 kg for NaOH).

In the situation considered one should be able to produce from one liter of water 1220 liters of hydrogen and 622 liters of oxygen giving

$$V(H_2)/V(H_2O) = 1.220 \times 10^3 , \quad V(O_2)/V(H_2O) = .622 \times 10^3 ,$$

$$r(gas) = V(H_2 + O_2)/V(H_2O) = 1.844 \times 10^3 , \quad V(H_2)/V(O_2) \simeq 1.96 .$$

$V(H_2)/V(O_2) \simeq 1.96$  is 4 per cent smaller than the prediction  $V(H_2)/V(O_2) = 2$  of the ideal gas approximation.

The volumes of  $O_2$  and  $H_2$  are not reported separately. The table gives the total volumes of gas produced and ratios to the volume of water used.

	$M(H_2O)/kg$	$V(gas)/m^3$	$\frac{V(gas)}{V(H_2O)}$	$\frac{[V(gas)/V(H_2O)]}{r(gas)}$
KOH	.272	8.75	$3.2 \times 10^4$	17.4
NaOH	.445	12.66	$2.8 \times 10^4$	15.2

Table 1. The weight of water used in the electrolysis and the total volume of gas produced for KOH and NaOH electrolysis.  $r(gas)$  denotes the naive prediction for the total volume of gas per water volume appearing in previous table. For KOH *resp.* NaOH the volume ratio  $[V(gas)/V(H_2O)]$  is by a factor  $r = 17.4$  *resp.*  $r = 15.2$  higher than the naive estimate.

### Findings of Mizuno

Mizuno in turn found that the Fe cathode contains Si, K, Cr, Fe, Cu for both KOH and NaOH electrolysis and in case of NaOH also Al, Sl, Ca. The fraction of these nuclei is of order one per cent. The table below gives the fractions for both KOH and NaOH.

KOH				
Element(Z,N)	Al(13,27)	Si(14,28)	Cl(17,18)	K(19,20)
		0.94		4.50
Element(Z,N)	Ca(20,20)	Cr(24,28))	Fe(26,29)	Cu(29,34)
		1.90	93.0	0.45
NaOH				
Element(Z,N)	Al(13,27)	Si(14,28)	Cl(17,18)	K(19,20)
	1.10	0.55	0.20	0.60
Element(Z,N)	Ca(20,20)	Cr(24,28))	Fe(26,29)	Cu(29,34)
	0.40	1.60	94.0	0.65

Table 2. The per cent of various nuclei in cathode for KOH and NaOH electrolysis.

The results supports the view that nuclear reactions involving new nuclear physics are involved and that part of  $H_2$  and  $O_2$  could be produced by nuclear reactions at the cathode.

1. For *Si*, *K*, *Cr*, *Fe*, and *Cu* the mechanism could be common for both *NaOH* and *KOH* electrolysis and presumably involve fission of *Fe* nuclei. The percent of *K* in *KOH* is considerably larger than in *NaOH* case and this is presumably due to the absorption of  $K^+$  ions by the cathode.
2. For *Al*, *Si*, and *Ca* the reaction occurring only for *Na* should involve *Na* ions absorbed by the cathode and suffering cold fusion with some particles -call them just *X* - to be identified.
3. *Cu* is the only element heavier than *Fe* and is expected to be produced by fusion with *X*. Quite generally, the fractions are of order one per cent.
4. The authors suggests that the extra volume of  $H_2$  and  $O_2$  molecules is due to nuclear reactions in the cathode. A test for this hypothesis would be the ratio of  $H_2$  and  $O_2$  volumes. Large deviation from value 2 would support the hypothesis. The value near 2 would in turn support the hypothesis that the water produced by electrolysis is considerably denser than ordinary water.

### 7.3.2 $H_{1.5}O$ anomaly and nuclear string model

It would seem that some exotic nuclei, perhaps consisting of protons, should be involved with the cold fusion. Concerning the identification of these exotic particles there are several guidelines.

$H_{1.5}O$  anomaly, anomalous production of  $e^+e^-$  pairs in heavy ion collisions, and nuclear string model.

### $H_{1.5}O$ anomaly and anomalous production of electron-positron pairs in heavy ion collisions

There exists an anomaly which could be explained in terms of long open nuclear strings. The explanation of  $H_{1.5}O$  anomaly [D12, D11, D16, D24] discussed in [K23] as a manifestation of dark protons was one of the first applications of TGD based ideas about dark matter. The proposed explanation is that the fraction of 1/4 of protons is in atto-second time scale dark and invisible in electron scattering and neutron diffraction. Note that atto-second time scale corresponds to the time during which light travels a length of order atomic size.

A natural identification of the dark protons would be in terms of protonic strings behaving like nuclei having anomalously large size, which would be due to the anomalously large value of Planck constant. A partial neutralization by negatively charge color bonds would make these states stable.

The TGD based explanation of anomalous production of electron-positron pairs in the collisions of heavy nuclei just above the Coulomb wall [K79] is in terms of lepto-pions consisting of pairs of color octet electron and positron allowed by TGD and having mass slightly below  $2m_e \simeq 1$  MeV. The strong electromagnetic fields created in collision create coherent state of lepto-pions decaying into electron positron pairs.

### Nuclear string model

The nuclear string model describes nuclei as string like structures with nucleons connected by color magnetic flux tubes whose length is of order electron Compton length about  $10^{-12}$  meters and even longer and thus much longer than the size scale of nuclei themselves which is below  $10^{-14}$  meters. Color magnetic flux tubes define the color magnetic body of nucleus and each flux tube has colored fermion and anti-fermion at its ends. The net color of pair is non-vanishing so that color confinement binds the nucleons to the nuclear string. Nuclei can be visualized as structures analogous to plants with nucleus taking the role of seed and color magnetic body of much larger size taking the role of plant with color flux tubes however returning back to another nucleon inside nucleus.

One can imagine two basic identifications of the fermions.

1. For the first option fermions are identified as quarks. The color flux tube can have three charge states  $q = +1, 0, -1$  according to whether it corresponds to  $u\bar{d}, u\bar{u} + d\bar{d}$ , or  $\bar{u}d$  type state for quarks. This predicts a rich spectrum of exotic nuclei in which neutrons consist actually of proton plus negatively charged flux tube. The small mass difference between neutron and proton and small mass of the quarks (of order MeV) could quite well mean that these exotic nuclei are identified as ordinary nuclei. The findings of [C28] [C28] support the identification as quarks.
2. Lepto-hadron hypothesis [K79] encourages to consider also the possibility that color bonds have color octet electrons at their ends. This would make it easier to understand why lepto-pions are produced in the collisions of heavy nuclei.
3. One can also consider the possibility that the color bonds are superpositions of quark-antiquark pairs and colored electron-positron pairs.

### Two options

One can consider two options for protonic strings. Either their correspond to open strings connected by color magnetic flux tubes or protons are dark so that giant nuclei are in question.

#### 1. Protonic strings as open strings?

Color flux tubes connecting nucleons are long and one can ask whether it might be possible also open nuclear strings with long color flux tubes connecting widely separate nucleons even at atomic distance. These kind of structures would be favored if the ends of nuclear string are charged.

Even without assumption of large values of Planck constant for the color magnetic body and quarks the net length of flux tubes could be of the order of atomic size. Large value  $\hbar$  would imply an additional scaling.

The simplest giant nuclei constructible in this manner would consist of protons connected by color magnetic flux tubes to form an open string. Stability suggest that the charge per length is not too high so that some minimum fraction of the color bonds would be negatively charged. One could speak of exotic counterparts of ordinary nuclei differing from them only in the sense that size scale is much larger. A natural assumption is that the distance between charged protonic space-time sheets along string is constant.

In the sequel the notation  $X(z, n)$  will be used for the protonic string containing net charge  $z$  and  $n$  negatively charged bonds.  $a = z + n$  will denote the number of protons.  $z, n$  and  $a$  are analogous to nuclear charge  $Z$ , neutron number  $N$ , and mass number  $A$ . For open strings the charge is  $z \geq 1$  and for closed strings  $z \geq 0$  holds true.

This option has however problem. It is difficult imagine how the nuclear reactions could take place. One can imagine ordinary stringy diagrams in which touching of strings means that proton of protonic string and ordinary nucleus interact strongly in ordinary sense of the word. It is however difficult to imagine how entire protonic string could be absorbed into the ordinary nucleus.

### 2. Are protons of the protonic string dark?

Second option is that protonic strings consist of dark protons so that nuclear space-time-sheet has scale up size, perhaps of order atomic size. This means that fermionic charge is distributed in much larger volume and possibly also the fermions associated with color magnetic flux tubes have scaled up sized. The value  $\hbar = 2^{11} \hbar_0$  would predict Compton length of order  $10^{-12}$  m for nucleon and upper size of order  $10^{-11}$  for nuclei.

Cold nuclear reactions require a transformation of dark protons to ordinary ones and this requires leakage to the sector of the imbedding space in which the ordinary nuclei reside (here the book metaphor for imbedding space is very useful). This process can take place for a neutral part of protonic string and involves a reduction of proton and fermion sizes to normal ones. The phase transition could occur first only for a neutral piece of the protonic string having charges at its ends and initiate the nuclear reaction. Part of protonic string could remain dark and remaining part could be "eaten" by the ordinary nucleus or dark protonic string could "eat" part of the ordinary nuclear string. If the leakage occurs for the entire dark proton string, the nuclear reaction itself is just ordinary nuclear reaction and is expected to give out ordinary nuclei. What is important that apart from the crucial phase transition steps in the beginning and perhaps also in the end of the reaction, the model reduces to ordinary nuclear physics and is in principle testable.

The basic question is how plasma phase resulting in electrolysis leads to the formation of dark protons. The proposal [K26] that the transition takes place with perturbative description of the plasma phase fails, might be more or less correct. Later a more detailed nuclear physics picture about the situation emerges.

### 3. What happens to electrons in the formation of protonic strings?

One should answer two questions.

1. What happens to the electrons of hydrogen atoms in the formation of dark protonic strings?
2. In plasma electrolysis the increase of the input voltage implies a mysterious reduction of the electron current with the simultaneous increase of the size of the plasma region near the cathode [C22]. This means reduction of conductance with voltage and thus non-linear behavior. Where does electronic charge go?

Obviously the negatively charged color bond created by adding one proton to a protonic string could take the charge of electron and transform electrons as charge carriers to color bonds of dark  $Li$  isotopes which charge  $Z = 3$  by gluing to existing protons sequence proton and negatively charged color bond. If the proton comes from  $H_2O$   $OH^-$  replaces electron as a charge carrier. This would reduced the conductivity since  $OH^-$  is much heavier than electron. This kind of process and its reversal would take place in the transformation of hydrogen atoms to dark proton strings and back in atto-second time scale.



The color bond could be either  $\bar{u}d$  pair or  $e_8\bar{\nu}_8$  pair or quantum superposition of these. The basic vertex would involve the exchange of color octet super-symplectic bosons and their neutrino counterparts. Lepton number conservation requires creation of color singlet states formed of color octet neutrinos which are bosons and carrying lepton number -2. One color confined neutrino pair would be created for each electron pair consumed in the process and might escape the system: if this happens, the process is not reversible above the time scale defined by colored neutrino mass scale of order .1 eV which happens to be of order .1 atto-seconds for ordinary neutrinos. Also ordinary nuclei could consist of nucleons connected by identical neutral color bonds (mostly).

The exchange of light counterparts of charged  $\rho$  mesons having mass of order MeV could lead to the transformation of neutral color bonds to charged ones. In deuterium cold fusion the exchange of charged  $\rho$  mesons between  $D$  and  $Pd$  nuclei could transform  $D$  nuclei to states behaving like di-neutrons so that cold fusion for  $D$  could take place. In the earlier proposal exchange of  $W^+$  boson of scaled variant of weak interactions was proposed as a mechanism.

The formation of charged color bonds binding new dark protons to existing protonic nuclear strings or giving rise to the formation of completely new protonic strings would also increase of the rates of cold nuclear reactions.

Note that this picture leaves open the question whether the fermions associated with color bonds are quarks or electrons.

### **Nuclei and their dark variants must have same binding energy scale at nuclear quantum criticality**

The basic question is what happens to the scale of binding energy of nuclei in the zooming up of nuclear space-time sheet. Quantum criticality requires that the binding energies scales must be same.

1. Consider first the binding energy of the nuclear strings. The highly non-trivial prediction of the nuclear string model is that the contributions of strong contact interactions at nuclear space-time sheet (having size  $L < 10^{-14}$  m) to the binding energy vanish in good approximation for ground states with vanishing strong isospin. This means that the binding energy comes from the binding energy assignable to color bonds connecting nucleons together.
2. Suppose that this holds true in a good approximation also for dark nuclei for which the distances of nucleons at zoomed up nuclear space-time sheet (having originally size below  $10^{-14}$  meters) are scaled up. As a matter of fact, since the scale of binding energy for contact interactions is expected to reduce, the situation is expected to improve. Suppose that color bonds with length of order  $10^{-12}$  m preserve their lengths. Under these assumptions the nuclear binding energy scale is not affected appreciably and one can have nuclear quantum criticality. Note that the length for the color bonds poses upper limit of order 100 for the scaling of Planck constant.

It is essential that the length of color bonds is not changed and only the size of the nuclear space-time sheet changes. If also the length and thickness of color bonds is scaled up then a naive scaling argument assuming that color binding energy related to the interaction of transforms as color Coulombic binding energy would predict that the energy scales like  $1/\hbar$ . The binding energies of dark nuclei would be much smaller and transformation of ordinary nuclei to dark nuclei would not take place spontaneously. Quantum criticality would not hold true and the argument explaining the transformation of ordinary  $Li$  to its dark counterpart and the model for the deuterium cold fusion would be lost.

### **7.3.3 A model for the observations of Mizuno**

The basic objection against cold nuclear reactions is that Coulomb wall makes it impossible for the incoming nuclei to reach the range of strong interactions. In order that the particle gets to the cathode from electrolyte it should be positively charged. Positive charge however implies Coulomb wall which cannot be overcome with the low energies involved.

These two contradictory conditions can be satisfied if the electrolysis produces exotic phase of water satisfying the chemical formula  $H_{1.5}O$  with 1/4 of protons in the form of almost neutral

protonic strings can possess only few neutral color bonds. The neutral portions of the protonic string, which have suffered phase transition to a phase with ordinary Planck constant could get very near to the target nucleus since the charges of proton can be neutralized in the size scale of proton by the charges  $\bar{u}$  and  $d$  quarks or  $e$  and  $\bar{\nu}$  associated with the two bonds connecting proton to the two neighboring protons. This could make possible cold nuclear reactions.

It turns out that the model fixes protonic strings to isotopes of dark Lithium (with neutrons replaced with proton plus negatively charged color bond). What is intriguing is that the biologically most important ions (besides  $Na^+$ )  $Cl^-$ ,  $K^+$ , and  $Ca^{++}$  appear at the cathode in Kanarev's plasma electrolysis actually result as outcomes of cold nuclear reactions between dark  $Li$  and  $Na^+$ .

### General assumptions of the model

The general assumptions of the model are following.

1. Ordinary nuclei are nuclear strings, which can contain besides neutrons also "pseudo-neutrons" consisting of pairs of protons and negatively charged color bonds. The model for  $D$  cold fusion requires that the  $Pd$  nuclei contain also "pseudo-neutrons".
2. Reaction products resulting in the fusion of exotic protonic string transforming partially to ordinary nuclear matter (if originally in dark phase) consist of the nuclei detected in the cathode plus possibly also nuclei which form gases or noble gases and leak out from the cathode.
3.  $Si$ ,  $K$ ,  $Cr$ , and  $Cu$  are produced by the same mechanism in both KOH and NaOH electrolysis.
4.  $Al$ ,  $Cl$ , and  $Ca$  is produced by a mechanism which must involve cold nuclear reaction between protonic string and Na ions condensed on the cathode.
5.  $Cu(Z, N) = Cu(29, 34)$  is the only product nucleus heavier than  $Fe(26, 29)$ . If no other nuclei are involved and Cu is produced by cold fusion

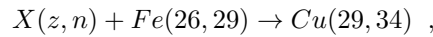

the anatomy of protonic string must be

$$X(z, n) = X(3, 5)$$

so that dark variant  $Li(3, 5)$  having charge 3 and mass number 8 would be in question.  $X(3, 5)$  would have 2 neutral color bonds and 5 negatively charged color bonds. To minimize Coulomb interaction the neutral color bonds must reside at the ends of the string. For quark option one would have charge  $1 + 2/3$  at the first end and  $1 + 1/3$  at the second end and charges of all protons between them would be neutralized. For color octet lepton color bond one would have charge 2 at the other end and zero at the other end.

For quark option the net protonic charge at the ends of the string causing repulsive interaction between the ends could make protonic string unstable against transition to dark phase in which the distance between ends is much longer even if the ends are closed within scaled up variant of the nuclear volume.

Arbitrarily long strings  $X(3, n)$  having neutral bonds only at their ends are possible and their fusions lead to neutron rich isotopes of  $Cu$  nucleus decaying to the stable isotope. Hence the prediction that only  $Cu$  is produced is very general.

The simplest dark protonic strings  $X(3, n)$  have quantum numbers of  $Li(3, n)$ . One of the hard problems of Big Bang cosmology is that the measured abundance of lithium is by a factor of about 2.5 lower than the predicted abundance [E13]. The spontaneous transformation of  $Li(3, n)$  isotopes to their dark variants could explain the discrepancy. Just by passign notice that  $Li$  has mood stabilizing effect [C4]: the spontaneous transformation of  $Li^+$  to its dark variant might relate to this effect.

### Production mechanisms for the light nuclei common to $Na$ and $K$

These nuclei must be produced by a fission of  $Fe$  nuclei.

1. For  $Si(14, 14)$  production the mechanism would be cold fission of  $Fe$  nucleus to two parts in the collision with the protonic string:

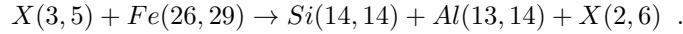

$X(2, 6)$  represent dark or ordinary  $He(2, 6)$ . As a noble gas  $He$  isotope would leave the cathode.

Note that arbitrarily long proton strings with two neutral bonds at their ends give neutron rich isotope of  $Si$  and exotic or ordinary isotope of  $He$  so that again the prediction is very general.

2.  $K(19, 20)$  is produced much more in KOH which most probably means that part of  $K^+$  is absorbed from the electrolyte. In this case the reaction could proceed as follows:

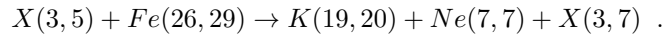

Note that the neutron number could be distributed in many manners between final states. For arbitrarily long proton string with two neutral bonds at ends higher neutron rich isotopes of  $K$  and  $Ne$  are produced. As noble gas  $Ne$  would leak out from the cathode.

Ordinary  $Li(3, 7)$  would decay by neutron emission to stable isotopes of  $Li$ . The temperature of the system determines whether  $Li$  boils out (1615 K under normal pressure).  $Li$  is not reported to appear in the cathode. In plasma electrolysis the temperature is in the interval  $.5 \times 10^4$ -  $10^4$  C and around  $10^3$  C in the ordinary electrolysis so that the high temperature might explain the absence of  $Li$ . Also the in-stability of  $Li$  isotopes against transition to dark  $Li$  in electrolyte would imply the absence of  $Li$ .

3. For  $Cr(24, 28)$  production the simplest reaction would be

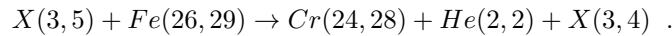

Helium would leak out as noble gas. Proton string would shorten by one unit and keep its charge.  $X(3, 4)$  would represent the stable isotope  $Li(3, 4)$  or its dark counterpart and what has been said in 2) applies also now.

### How to understand the difference between KOH and NOH?

One should understand why  $Al$ ,  $Cl$ , and  $Ca$  are not detected in the case of  $KOH$  electrolysis.

$Al$ ,  $Cl$ , and  $Ca$  would be created in the fusion of protonic strings with  $Na(11, 12)$  nuclei absorbed by the cathode. With this assumption the rates are expected to be of same order of magnitude for all these processes as suggested by the one per cent order of magnitude for all fractions.

One can imagine two reaction mechanisms.

**I:** One could understand the production assuming only  $X(3, 5)$  protonic strings if the number of  $X(3, 5)$  strings absorbed by single  $Na$  nucleus can be  $k = 1, 2, 3$  and that nuclear fission can take place after each step with a rate which is slow as compared to the rate of absorptions involving also the phase transition to dark matter. This is however highly implausible since ordinary nuclear interactions are in question.

**II:** Second possibility is that the protonic strings appearing with the highest probability are obtained by fusing copies of the basic string  $X(3, 5)$  by using neutral color bond between the strings. The minimization of electrostatic energy requires that that neutral color bonds are equally spaced so that there are three completely neutralized protons between non-neutralized protons.

One would have thus at least the strings  $X(3, 5)$ ,  $X(6, 10)$ , and  $X(9, 15)$ , which correspond to dark  $Li(3, 5)$  and dark variants of the unstable isotopes  $C(6, 10)$  and  $F(9, 15)$ . In nuclear string

model also ordinary nuclei are constructed from  $He(2, 2)$  strings and lighter strings in completely analogous manner, and one could perhaps see the dark nuclei constructed from  $Li(3, 5)$  as the next level of hierarchy realized only at the level of dark matter.

The charge per nucleon would be  $3/8$  and the length of the string would be a multiple of 8. Interestingly, the numbers 3, 5, and 8 are subsequent Fibonacci numbers appearing very frequently also in biology (micro-tubules, sunflower patterns). The model predicts also the occurrence of cold fusions  $X(z = 3k, n = 5k) + Fe(26, 29) \rightarrow (Z, N) = (26 + 3k, 29 + 5k)$ . For  $k = 2$  this would give  $Ge(32, 39)$  which is stable isotope of  $Ge$ . For  $k = 3$  one would have  $(Z, N) = (35, 44)$  which is stable isotope of  $Br$  [C27, C6] .

Consider now detailed description of the reactions explaining the nuclei detected in the cathode.

1.  $Al(13, 14)$  would be produced in the reaction

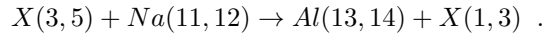

$H(1, 3)$  or its dark variant could be in question. Also the reaction  $X(3, 5) + Na(11, 12) \rightarrow Al(13, 17) + p$ , where  $Al(12, 17)$  is an unstable isotope of  $Al$  is possible.

The full absorption of protonic string would yield  $Si(14, 17)$  beta-decaying to  $P(15, 16)$ , which is stable. Either  $P$  leaks out from the cathode or full absorption does not take place appreciably.

2.  $Cl(17, 18)$  would be produced by the sequence

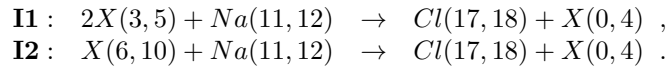

$X(0, 4)$  represents ordinary or dark tetra-neutron [C42, C17, C12] . The instability of the transformation of tetra-neutron to dark matter could explain why its existence has remained controversial.

If the protonic string were absorbed completely, the resulting  $Cl(17, 22)$  - if equivalent to ordinary nucleus - would transform via beta-decays to  $A(18, 23)$  and then to  $K(19, 22)$ , which is stable and detected in the target.

3.  $Ca(20, 20)$  would be produced in the reaction

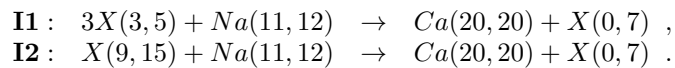

$X(0, 7)$  would be dark counterpart of "septa-neutron". The complete absorption of nuclear string would produce  $Ca(20, 27)$ , which (if ordinary nucleus) transforms via beta decays to  $Sc(21, 26)$  and then to  $Ti(22, 25)$ , which is stable.

### 7.3.4 Comparison with the model of deuterium cold fusion

It is interesting to compare the model with the model for cold fusion [C35, C1] reported using deuterium target and  $D_2O$  instead of water.

#### Earlier model

1. The model is based on the assumption that  $D$  nuclei in the target suffer a phase transition to a state in which  $D$  nuclei become neutral so that the color bond between neutron and proton becomes negatively charged: one has effectively di-neutrons.
2. The mechanism of charging of color bond must either involve weak interactions or exchange of lepto- $\rho$  mesons already discussed briefly. The proposal is that the exchange of  $W$  bosons of scaled up version of weak physics is involved with the range of interactions given by atomic length scale. The exchange of  $W^+$  bosons was assumed to take place between  $Pd$  and  $D$  nuclei. This mechanism could lead to the formation of negatively charged color bonds in also ordinary nuclei.

3. The neutrality of exotic  $D$  nuclei allows to overcome Coulomb wall. One can understand the reported selection rules: in particular the absence of Helium isotopes (only isotopes of  $H$  are detected). The absence of gamma rays can be understood if the resulting gamma rays are dark and leak out before a transformation to ordinary gamma rays.

### Are $D$ nuclei in $Pd$ target dark or not?

The question whether the exotic  $D$  nuclei are dark was left pending. The recent model suggests that the answer is affirmative.

1. The basic difference between the two experiments would be that in Kanarev's experiments incoming nuclei are dark whereas in  $D$  fusion cathode contains the dark nuclei and cold nuclear reactions occur at the "dark side" and is preceded by ordinary-to-dark phase transition for incoming  $D$ .
2.  $D$  cold fusion occurs for a very restricted range of parameters characterizing target: the first parameter is doping ratio: essentially one  $D$  nucleus per one  $Pd$  nucleus is needed which would fit with the assumption that scaled up size is of the order of atom size. Temperature is second parameter. This and the fact that the situation is highly sensitive to perturbations conforms with the interpretation as a phase transition to dark matter occurring at quantum criticality.
3. The model for Kanarev's findings forces to consider the possibility that dark  $D$  nuclei combine to form longer strings and can also give rise to dark  $Li(3, 5)$  explaining the observed nuclear transmutations in the target.
4. In cold nuclear reactions incoming nuclei would transform to dark nuclei (the picture as a leakage between different pages of a book like structure defined by the generalized imbedding space is helpful). The reaction would take place for dark nuclei in zoomed up nuclear physics and the reaction products would be unstable against phase transition to ordinary nuclei.
5. Is it then necessary to assume that target  $D$  nuclei are transformed to neutral ones (di-neutrons effectively) in order to have cold nuclear reactions? Nuclear space-time sheets are scaled up. If nucleon space-time sheets are not scaled up,  $p$  and  $n$  are connected by color magnetic flux tubes of same length as in the case of ordinary nuclei but located at much larger nuclear space-time sheet. The classical analog for the quantal distribution of nucleon charges is even charge distribution in a sphere or radius  $R$  defined by the charge of the scaled up nucleus. The height of the Coulomb wall is  $E_c = e^2/R$ . If  $R = a$ ,  $a$  the atomic radius, one has  $E_c \sim .1$  keV. The wall is by a factor  $10^{-4}$  lower than in ordinary nuclear collision so that the incoming  $D$  nucleus might overcome the Coulomb wall.

If Coulomb wall can be overcome, all dark variants of  $D + D$  reaction are possible. Helium nuclei have not been however detected, which supports the view that  $D$  in target is transformed to its neutral variant. Gamma rays would be dark and could leak out without detection which would explain the absence of gamma rays.

### Nuclear quantum criticality is essential

A note about the energetics of cold nuclear reactions is in order. The nuclear quantum criticality deriving from the cancelation of the contact interaction energies between nucleons for isospin singlets and scaling up of *only* nuclear space-time sheet is an absolutely essential assumption. Otherwise dark  $D$  would have much smaller binding energy scale than the visible one, and ordinary  $D$  in the  $Pd$  target could not transform to dark "di-neutron" state. Also the transformation of incoming  $D$  to its dark variant  $D$  at cathode could not take place.

### 7.3.5 What happens to $OH$ bonds in plasma electrolysis?

For an innocent novice one strange aspect of hydrolysis is how the  $OH$  bonds having energies of order 8 eV can be split in temperatures corresponding to photon energies of order .5 eV. Kanarev has suggested his own theory for how this could happen [D28]. TGD suggests that  $OH$  bonds

are transformed to their dark variants with scaled down bond energy and that there might be no essential difference between  $OH$  bond and hydrogen bond.

### The reduction of energy of $OH$ bonds in plasma electrolysis

Kanarev has found that in plasma electrolysis the energy of  $OH$  bonds is reduced from roughly 8 eV to about .5 eV, which corresponds to the fundamental metabolic energy quantum identifiable as the zero point kinetic energy liberate as proton drops from  $k = 137$  space-time sheet to much larger space-time sheet. In pyrolysis [D6] similar reduction could occur since the pyrolysis occurs above temperature about 4000 C conforming with the energy scale of hydrogen bond.

The explanation discussed in [K78] is that there is some mechanism exciting the bonds to a state with much lower bond energy. Dark matter hierarchy [K26] suggests that the excitation corresponds to the transformation of  $OH$  bond to dark bond so that the energy scale of the state is reduced.

Also in the ordinary electrolysis of water [D2] the energy of  $OH$  bonds is reduced to about 3.3 eV meaning a reduction factor of order 2. The simplest interpretation would be as a transformation of  $OH$  bonds to dark  $OH$  bond with  $\hbar \rightarrow 2\hbar$  (the scaling could be also by some other integer or even rational). The energy needed to transform the bond to dark bond could come from remote metabolism via the dropping of dark protons from a dark variant of some sub-atomic space-time sheet with size not smaller than the size of the atomic space-time sheet to a larger space-time sheet.

In many-sheeted space-time (see fig. <http://www.tgdtheory.fi/appfigures/manysheeted.jpg> or fig. 9 in the appendix of this book) particles topologically condense at all space-time sheets having projection to given region of space-time so that this option makes sense only near the boundaries of space-time sheet of a given system. Also p-adic phase transition increasing the size of the space-time sheet could take place and the liberated energy would correspond to the reduction of zero point kinetic energy. Particles could be transferred from a portion of magnetic flux tube portion to another one with different value of magnetic field and possibly also of Planck constant  $h_{eff}$  so that cyclotron energy would be liberated.

$H_{1.5}O$  anomaly suggests that 1/4 of protons of water are dark in atto-second time scale [K23] and one can imagine that both protons of water molecule can become dark under conditions defined by plasma electrolysis. Also the atomic space-time sheets and electron associated with  $OH$  bonds could become dark.

Atomic binding energies transform as  $1/\hbar^2$ . If the energy of hydrogen bond transforms like Coulombic interaction energy as given by the perturbative calculation, it is scaled down as  $1/\hbar$  since the length of the bond scales up like  $\hbar$ . Effectively  $\alpha_{em} \propto 1/\hbar$  is replaced by its scaled down value. For  $\hbar \rightarrow 2^4\hbar_0$  the energy would scale from 8 eV to .5 eV and the standard metabolic energy quantum could induce the splitting of the dark  $OH$  bond. If  $2^4$  is the scale factor of  $\hbar$  for dark nuclear space-time sheets, their size would be of order  $10^{-3}$  meters. The model for cold fusion is consistent with this since what matters is different value of Planck constant for the dark nuclear space-time sheets.

There is an objection against the reduction of  $OH$  bond energy. The bonds could be split by a process in which dark nuclear reactions kick protons to  $k = 133$  dark space-time sheet. In this case the maximal zero point kinetic energy liberated in the dropping back would be 8 eV and could induce breaking of  $OH$  bond. For  $\hbar/\hbar_0 \geq 4$  the size of  $k = 133$  dark space-time sheet would be larger than the size of  $k = 137$  atomic space-time sheet.

### Are hydrogen bonds dark $OH$ bonds?

The fact that the energy of hydrogen bonds [D4] is typically around .5 eV forces to ask what distinguishes hydrogen bond from dark  $OH$  bond. Could it be that the two bonds are one and the same thing so that dark  $OH$  bonds would form standard part of the standard chemistry and molecular biology? In hydrogen bond same hydrogen would be shared by the oxygen atoms of the neighboring atoms. For the first  $O$  the bond would be ordinary  $OH$  bond and for the second  $O$  its dark variant with scaled down Coulomb energy. Under conditions making possible pyrolysis and plasma electrolysis both bonds would become dark. The variation of the hydrogen bond energy could reflect the variation of the scaling factor of  $\hbar$ .

The concentration of the spectrum of bond energies on integer multiples of fundamental energy scale - or even better, on powers of 2 - would provide support for the identification. There is evidence for two kinds of hydrogen bonds with bond energies in ratio 1:2 [D32] : the TGD based model is discussed in [K23] .

### Mechanism transforming $OH$ bonds to their dark counterparts

The transformation of  $OH$  bonds to dark bonds would occur both in ordinary and plasma electrolysis and only the change of Planck constant would distinguish between the two situations.

1. Whatever the mechanism transforming  $OH$  bonds to their dark counterparts is, metabolic energy is needed to achieve this. Kanarev also claims over-unity energy production [D28] . Cold fusion researchers make the same claim about ordinary electrolysis. Cold nuclear reactions between  $Na^+$  ( $K^+$ ) and dark protons and dark  $Li$  could obviously serve as the primary energy source. This would provide the fundamental reason for why  $NaOH$  or  $KOH$  must be present. Cold nuclear reactions would thus occur also in the ordinary electrolysis of water and provide the energy inducing the transition of  $OH$  bonds to dark ones by (say)  $\hbar \rightarrow 2\hbar$  transition.
2. One can imagine several metabolic mechanisms for the visible-to-dark transformation of  $HO$  bonds. The energy spectrum of cold nuclear reactions forms a continuum whereas the energies needed to transform  $OH$  bonds to their dark variants presumably are in narrow bands. Therefore the energy liberated in cold nuclear reactions is not probably used as such. It is more plausible that standard metabolic energy quanta liberated in the dropping of protons (most naturally) to larger space-time sheets are utilized. The most important metabolic energy quanta for the dropping of proton come as  $E_k = 2^{k-137}kE_0$ :  $E_0 = .5$  eV is liberated in the dropping of proton from atomic space-time sheet ( $k = 137$ ) to much larger space-time sheet (the discrete spectrum of increments of the vacuum energy in the dropping approaches this energy [K49] ). The energy liberated in the dark nuclear reactions would "load metabolic batteries" by kicking the dark protons to the dark variants of  $k < 137$  space-time sheet (the size of dark atomic space-time sheet scales like  $\hbar$ ). Their dropping to larger space-time sheets would liberate photons with energies near to those transforming  $OH$  bonds to hydrogen bonds.
3. A signature for the standard metabolic energy quanta would be visible light at  $2eV$  and also discrete lines below it accumulating to  $2eV$ . Kanarev's indeed reports the presence of red light [D28] as a signature for the occurrence of process.

### 7.3.6 A model for plasma electrolysis

Kanarev's experiments involve also other strange aspects which lead to the view that cold nuclear reactions and dark matter physics are essential aspects of not only plasma electrolysis of Kanarev but also of ordinary electrolysis and responsible for the claimed over unity energy production. Biologically important ions are produced in reactions of dark  $Li$  and  $Na^+$  and there is very strong electric voltage over the cell membrane. This inspires the question whether cold nuclear reactions serve as a metabolic energy source in living cell and are also responsible for production of ions heavier than  $Na^+$ .

#### Brief description of plasma electrolysis

Electrolysis [D2] , pyrolysis [D6] , and plasma electrolysis [C22] , [D28] of water are methods of producing free hydrogen. In pyrolysis the temperature above 4000 C leads to hydrogen and oxygen production. Oxygen production occurs also at cathode and hydrogen yield is higher than given by Faraday law for ordinary electrolysis [D2] .

The article of Mizuno and collaborators [C22] about hydrogen production by plasma electrolysis contains a brief description of plasma electrolysis. A glow discharge occurs as the input voltage used in electrolysis is above a critical value and plasma is formed near cathode. In the arrangement of [C22] plasma state is easily achieved above 140 V. If the values of temperature and current

density are right, hydrogen generation in excess of Faraday's law as well as a production of oxygen at cathode (not possible in ideal electrolysis) are observed. Above 350 V the control of the process becomes difficult.

### What really happens in electrolysis and plasma electrolysis?

#### 1. Ordinary electrolysis

To understand what might happen in the plasma electrolysis consider first the ordinary electrolysis of water.

1. The arrangement involves typically the electrolyte consisting of water plus  $NaOH$  or  $KOH$  without which hydrolysis is impossible for thermodynamical reasons.
2. Electronic current flows from the anode to cathode along a wire. In electrolyte there is a current of positively charged ions from anode to cathode. At the cathode the reaction  $2H_2O + 2e^- \rightarrow 2H_2 + 2OH^-$  yields hydrogen molecules seen as bubbles in water. At the anode the reaction  $2H_2O \rightarrow O_2 + 4H^+ + 4e^-$  is followed by the reaction  $2H^+ + 2e^- \rightarrow H_2$  and the flow of  $2e^-$  to the cathode along wire. The net outcome is hydrolysis:  $H_2O \rightarrow 2H_2 + 2O_2$ . Note that  $O_2$  is produced only at anode and  $H_2$  at both anode and cathode.

#### 2. What happens in plasma electrolysis?

In plasma electrolysis something different might happen.

1. Cold nuclear reactions should take place at cathode in presence of  $Na^+$  ions plus dark  $Li$  and should be in equilibrium under ordinary conditions and contribute mainly to the formation of dark  $OH$  bonds. The rate of cold nuclear reactions increases with input voltage  $V$  since the currents of  $Na^+$  and dark  $Li$  to the cathode increase. Obviously the increased rate of energy yield from dark nuclear reactions could be the real reason for the formation of plasma phase above critical voltage.
2. By previous considerations the reduction of electron current above critical voltage has interpretation as a transition in which electronic charge is transferred to negative charge of color bonds of dark proton strings. Existing protonic strings could grow longer and also new strings could be created from the ionized hydrogen resulting in the electrolysis of water. The increase of the size of the dark nuclei would mean increase of the cross sections for cold nuclear reactions. The liberated energy would ionize hydrogen atoms and give rise to a positive feedback loop somewhat like in ordinary nuclear reactions.
3. The increased energy yield in cold nuclear reactions suggests that  $OH$  bonds are transformed very effectively to dark  $OH$  bonds in the plasma region. This means that the thermal radiation can split the hydrogen bonds and induce the splitting of two water molecules to  $4H$  and  $2O$  and therefore production of  $2H_2 + O_2$  everywhere in this kind of region. The temperature used by Kanarev corresponds to energy between .5-1 eV [D28] which conforms with the fact that  $OH$  bond energy is reduced to about .5 eV. Note that the presence of anode and cathode is not absolutely necessary if cold nuclear reactions can take place in the entire electrolyte volume and generate plasma phase by positive feedback loop.
4. The prediction is that Faraday's law for hydrogen production does not hold true.  $O/H$  ratio has the value  $r = O/H = 0$  for the ordinary electrolysis at cathode.  $r = 1/2$  holds true if local dissociation of water molecules dominates. According to [C22]  $r$  increases from electrolysis value  $r = .066$  above  $V = 140$  V achieving the value  $r = .45$  for  $V = 350$  V where the system becomes unstable. Also cold nuclear reactions could contribute to hydrogen and oxygen production and affect the value of  $r$  as suggested by the large volume of gas produced in Kanarev's experiments [D29].



### Over-unity energy production?

Over-unity energy production with output power 2- or even 3-fold as compared with input power has been reported from plasma electrolysis. The effectiveness is deduced from the heating of the system. Note that Mizuno reports in [C22] that 10 per cent effectiveness but this is for the storage of energy to hydrogen and does not take into account the energy going to the heating of water.

The formation of higher isotopes of  $Li$  by fusing dark protons to existing dark proton strings is a good candidate for the dominant energy production mechanism. An estimate for the energy liberated in single process  $Li(3, n) + m_p + e \rightarrow Li(3, n + 1) + 2\nu_8$  is obtained by using energy conservation. Here  $2\nu_8$  denotes color singlet bound state of two color octet excitations of neutrino.

Since  $e_8$  and  $\nu_8$  are analogous to  $u$  and  $d$  quarks one expects that their masses are very nearly the same. This gives as the first guess  $m_{\nu_8} = m_e$  and since lepto-pion (color bound state of color octet electrons, [K79]) has mass  $m = 2m_e$  a good guess is  $m(2\nu_8) = 2m_{\nu_8} = 2m_e$ . The energy conservation would give

$$m(Li(3, n)) + m_p = m(Li(3, n + 1)) + m_e + T(2\nu_8) + E(\gamma) . \quad (7.3.1)$$

Here  $T(2\nu_8)$  is the kinetic energy of  $2\nu_8$  state and  $E_\gamma$  is the energy of photon possibly also emitted in the process.

The process is kinematically possible if the condition

$$\Delta m = m(Li(3, n)) + m_p - m(Li(3, n + 1)) \geq m_e . \quad (7.3.2)$$

is satisfied. All incoming particles are approximated to be at rest, which is a good approximation taking into account that chemical energy scales are much lower than nuclear ones. For the left hand side one obtains from the mass difference of  $Li(3, n = 4)$  and  $Li(3, 5)$  isotopes the estimate  $\Delta m = 1.2312$  MeV for the liberated binding energy which is considerably larger than  $m_e = .51$  MeV. Hence the process is kinematically possible and  $2\nu_8$  would move with a relativistic velocity  $v = .81c$  and presumably leave the system without interacting with it.

The process can involve also the emission of photons and the maximal amount of energy that photon can carry out corresponds to  $E = \Delta m = 1.2312$  MeV. Let us denote by  $\langle E \rangle < \Delta m$  the average photonic energy emitted in the process and express it as

$$\langle E \rangle = z\Delta m , \quad z < 1. \quad (7.3.3)$$

One obtains an estimate for the production rate of photon energy (only this heats the system) from the incoming electron current  $I$ . If a fraction  $x(V)$  of the current is transformed to negatively charged color bonds the rate for energy production becomes by a little manipulation

$$\frac{P/kW}{I/A} = x(V)z \times 3.5945 . \quad (7.3.4)$$

This formula allows to estimate the value of the parameter  $x(V)z$  from experimental data. Since simplest Feynman graph producing also photons is obtained by adding photon line to the basic graph, one expects that  $z$  is of order fine structure constant:

$$z \sim \alpha_{em} = 1/137 . \quad (7.3.5)$$

The ratios of the excess power for a pair of  $(V, I)$  values should satisfy the condition

$$\frac{P(V_1)I(V_2)}{P(V_2)I(V_1)} = \frac{x(V_1)}{x(V_2)} . \quad (7.3.6)$$

$x(V)$  should be deducible as a function of voltage using these formulas if the model is correct.

These formulae allow to compare the predictions of the model with the experimental results of Naudin for Mizuno-Omori Cold Fusion reactor [C8]. The following table gives the values of  $\epsilon = x(V)z$  and ratios  $x(V(n))/x(V(n_1))$  deduced from the data tabulated by Naudin [C33] for the various series of experiments using the formulae above.

1. Most values of  $x(V)z$  are in the range .03 – .12.  $z = 1/137$  would give  $x(V)z \leq 1/137$  so that order of magnitude is predicted correctly. One cannot over-emphasize this result.
2. Apart from some exceptions the values look rather reasonable and do not vary too much. If one neglects the exceptional values, one has  $x_{max}(V)/x_{min}(V) < 4$ .  $n = 1, 5, 8, 9, 29$  correspond to exceptionally small values of  $x(V)$ . Perhaps cold fusion is not present for some reason. The output power is smaller than input power for  $n = 9$  and  $n = 29$ .

n	Voltage/V	Current/A	$x(V)z$	$x(V(n))/x(V(2))$
1	185	8.56	0.005	.145
2	147	2.45	0.036	1.00
3	215	2.10	0.046	1.30
4	220	9.32	0.044	1.22
5	145	1.06	0.001	.03
6	213	1.40	0.05	1.34
7	236	1.73	0.08	2.18
8	148	.83	0.01	.21
9	148	1.01	-0.00	-0.008
10	221	1.31	0.03	.87
11	279	3.03	0.05	1.46
12	200	8.58	0.03	0.89
13	199	7.03	0.07	1.91
14	215	9.78	0.04	1.07
15	207	8.34	0.03	0.74
16	247	2.19	0.06	1.69
17	260	2.20	0.02	0.55
18	257	2.08	0.03	0.71
19	195	2.95	0.06	1.59
20	198	2.62	0.07	1.98
21	182	2.40	0.05	1.26
22	212	2.27	0.06	1.74
23	259	2.13	0.12	3.22
24	260	4.83	0.04	1.05
25	209	3.53	0.04	1.16
26	230	4.99	0.10	2.79
27	231	5.46	0.09	2.53
28	233	5.16	0.10	2.85
29	155	4.60	-0.00	-0.04
30	220	4.44	0.11	2.95
31	256	5.25	0.05	1.36
32	211	3.68	0.03	.97
33	201	3.82	0.04	1.06

Table 3. The values of  $x(V)z$  and  $x(V(n))/x(V(1))$  deduced from the data of *Cold Fusion reaction-Experimental test results on June 25, 2003 by JL Naudin* at <http://jlnlabs.online.fr/cfr/html/cfrdatas.htm>.

### Has living matter invented cold nuclear physics?

Intriguingly, the ions  $Na^+, Cl^-, K^+, Ca^{++}$  detected by Mizuno in the cathode in Kanarev's experiments [D29] correspond to the most important biological ions. There is also a considerable evidence for the occurrence of nuclear transmutations in living matter [C30, C41]. For instance, Kervran claims that it is not possible to understand where the  $Ca$  needed to form the shells of eggs comes from. A possible explanation is that dark nuclear reactions between  $Na^+$  and dark Lithium produced the needed  $Ca$ .

There is extremely strong electric field through cell membrane (resting voltage is about .06 V). The acceleration of electrons in this field could generate plasma phase and creation of dark  $Li$  nuclei via a positive feedback loop. This could mean that cold nuclear reactions serve also in living cell as a basic metabolic energy source (possibly in the dark sector) and that also biologically important ions result as products of cold nuclear reactions.

### 7.3.7 Tests and improvements

#### Test for the hypothesis about new physics of water

The model involves hypothesis about new physics and chemistry related to water.

1. The identification of hydrogen bond as dark  $OH$  bond could be tested. One could check whether the qualitative properties of bonds are consistent with each. One could try to find evidence for quantization of bond energies as integer multiples of same energy (possible power of two multiples).
2.  $H_{1.5}O$  formula in atto-second scale should be tested further and one could look whether similar formula holds true for heavy water so that sequences of dark protons might be replaced with sequences of dark deuterons.
3. One could find whether plasma electrolysis takes place in heavy water.

#### Testing of the nuclear physics predictions

The model in its simplest form assumes that only dark  $Li$ ,  $C$ ,  $F$ , etc. are present in water. This predicts quite specific nuclear reactions in electrolyte and target and reaction product. For both target and electrolyte isotopes of nuclei with atomic number  $Z + k3$  are predicted to result in cold fusion reactions if energetically possible. For a target heavier than  $Fe$  also fission reactions might take place.

The estimates for the liberated energies are obtained assuming that dark nuclei have same binding energies as ordinary ones. In some cases the liberated energy is estimated using the binding energy per nucleon for a lighter isotope. Ordinary nuclei with maximal binding energy correspond to nuclear strings having  ${}^4He$  or its variants containing negatively charged color bonds as a basic structural unit. One could argue that gluing  $nLi(3, 5)$  or its isotope does not give rise to a ground state so that the actual energy liberated in the process is reduced so that process might be even impossible energetically. This could explain the absence of  $Ge$  from  $Fe$  cathode and the absence of  $Ti$ ,  $Mn$ , and  $Ni$  in  $KOH$  plasma electrolysis [D29].

**Cathode:** For cathode  $Fe$  and  $W$  have been used. For  $Fe$  the fusions  $Fe + Li \rightarrow Cu + 28.84 MeV$  and  $Fe + C \rightarrow Ge + 21.64 MeV$  are possible energetically. Mizuno does not report the presence of  $Ge$  in  $Fe$  target. The reduction of the binding energy of dark  $C(6, 10)$  by 21.64 MeV (1.35 MeV per nucleon) would make second reaction impossible but would still allow  $Li + C$  and  $Na + C$  fusion. Second possibility is that  $Ge$  containing negatively charged color bonds has smaller binding energy per nucleon than ordinary  $Ge$ .  $W + Li \rightarrow Ir$  would liberate 8.7 MeV if binding energy of dark  $Li$  is same as of ordinary  $Li$ .

**Electrolyte:** Consider electrolytes containing ions  $X^+$  with atomic number  $Z$ . If  $X$  is lighter than  $Fe$ , the isotopes of nuclei with atomic number  $Z + 3k$  might be produced in fusion reactions  $nLi + X$ .  $X = Li, K, Na$  has one electron at s-shell whereas  $B, Al, Cr, \dots$  has one electron at p-shell.

Reaction	<b>Li</b> + $Li \rightarrow C$	<b>C</b> + $Li \rightarrow F$	<b>F</b> + $Li \rightarrow Mg$
$E/MeV$	27.1	24.0	31.5
	<b>Li</b> + $Na \rightarrow Si$	<b>C</b> + $Na \rightarrow Cl$	<b>F</b> + $Na \rightarrow Ca$
$E/MeV$	34.4	30.5	33.7
	<b>Li</b> + $K \rightarrow Ti$	<b>C</b> + $K \rightarrow Mn$	<b>F</b> + $K \rightarrow Ni$
$E/MeV$	32.2	33.6	32.7

Table 5. The estimates for the energies liberated in fusions of dark nuclei of water and the ion of electrolyte. Boldface refers to dark nuclei  $Li(3, 5)$ ,  $C(6, 10)$ , and  $F(9, 15)$ .

### Relationship to the model of Widom and Larsen and further tests

W. Guglinski kindly informed me about the theory of cold fusion by Widom and Larsen [C45]. This theory relies on standard nuclear physics. The theory is reported to explain cold fusion reaction products nicely in terms of the transformation of electrons and protons to very low energy neutrons which can overcome the Coulomb barrier. The problem of the theory is that very high energy electrons are required since one has  $Q = .78$  MeV for  $e + p \rightarrow n$  and  $Q = -3.0$  MeV for  $e + D \rightarrow n + n$ . It is difficult to understand how so energetic electrons could result in ordinary condensed matter.

Since proton plus color bond is from the point of view of nuclear physics neutron and the fusion reactions would obey ordinary nuclear physics rules, the predictions of TGD are not expected to deviate too much from those of the model of Widom and Larsen.

An important class of predictions relate to ordinary nuclear physics. Tetra-neutron could be alpha particle with two negatively charged color bonds and neutron halos could consist of protons connected to nucleus by negatively charged color bonds. This could reduce the binding energy considerably.

Cold nuclear fusion might also provide an in situ mechanism for the formation of ores. Nuclear ores in places where they should not exist but involving remnants of organic matter would be the prediction. Cold fusion has a potential for a technology allowing to generate some metals artificially.

### How to optimize the energy production?

The proposed model for the plasma electrolysis suggests following improvements to the experimental arrangement.

The production of energy in process is due to three reactions: 1)  $Li+p$  in plasma. 2)  $Li+Fe/W...$  in target, and 3)  $Li + Na/K...$  in plasma. The model suggests that 1) dominates so that basic process would occur in plasma rather than cathode.

1. Since  $W$  does not evaporate so easily, it is better material for cathode if the production of dark  $Li$  dominates energy production.
2. Cathode could be replaced with a planar electrode with fractal peaky structure generating the required strong electric fields. This could increase the effectiveness of the energy production by increasing the effective area used.
3. Since  $H_2O \rightarrow OH^- + p$  is required by the generation of dark  $Li$  sequences. The energy feed must be able to follow the rapidly growing energy needs of this reaction which seems to occur as bursts.
4. The prediction is that the output power is proportional to electron current rather than input power. This suggests minimization of input power by minimizing voltage. This requires maximization of electron conductivity. Unfortunately, the transformation of electrons to  $OH^-$  ions as charge carriers reduces conductivity.

## 7.4 Anomalies possibly related to electrolysis of water and cold fusion

### 7.4.1 Burning salt water by radio-waves and cold fusion by plasma electrolysis

John Kanzius has made a strange discovery [D1]: salt water in the test tube radiated by radio waves at harmonics of a frequency  $f=13.56$  MHz burns. Temperatures about 1500 C, which correspond to .17 eV energy have been reported. One can radiate also hand but nothing happens. The original discovery of Kanzius was the finding that radio waves could be used to cure cancer by destroying the cancer cells. The proposal is that this effect might provide new energy source by liberating chemical energy in an exceptionally effective manner. The power is about 200 W so that the power used could explain the effect if it is absorbed in resonance like manner by salt water. In the following it is proposed that the cold nuclear reactions are the source of the energy.

### Do radio waves of large Planck constant transform to microwave photons or visible photons in the process?

The energies of photons involved are very small, multiples of  $5.6 \times 10^{-8}$  eV and their effect should be very small since it is difficult to imagine what resonant molecular transition could cause the effect. This leads to the question whether the radio wave beam could contain a considerable fraction of dark photons for which Planck constant is larger so that the energy of photons is much larger. The underlying mechanism would be phase transition of dark photons with large Planck constant to ordinary photons with shorter wavelength coupling resonantly to some molecular degrees of freedom and inducing the heating. Microwave oven of course comes in mind immediately. The fact that photosynthesis means burning of water and the fact that visible light is emitted in turn suggests that the radio wave photons are transformed to visible or nearly visible photons corresponding to the energy scale of photons involved with photosynthesis.

The original argument inspired by the analogy with microwave oven is discussed below. The generalization to the case of visible photons is rather straightforward and is discussed in [K23].

1. The fact that the effects occur at harmonics of the fundamental frequency suggests that rotational states of molecules are in question as in microwave heating. The formula for the rotational energies [D7] is

$$E(l) = E_0 \times (l(l+1)) \quad , \quad E_0 = \hbar_0^2 / 2\mu R^2 \quad , \quad \mu = m_1 m_2 / (m_1 + m_2) \quad .$$

Here  $R$  is molecular radius which by definition is deduced from the rotational energy spectrum. The energy inducing the transition  $l \rightarrow l+1$  is  $\Delta E(l) = 2E_0 \times (l+1)$ .

2. *NaCl* molecules crystallize to solid so that the rotational heating of *NaCl* molecules cannot be in question.
3. The microwave frequency used in microwave ovens is 2.45 GHz giving for the Planck constant the estimate 180.67 equal to 180 with error of .4 per cent. The values of Planck constants for  $(\hat{M}^4/G_a) \times CP_2 \times G_b$  option (factor space of  $M^4$  and covering space of  $CP_2$  maximizing Planck constant for given  $G_a$  and  $G_b$ ) are given by  $\hbar/\hbar_0 = n_a n_b$ .  $n_a n_b = 4 \times 9 \times 5 = 180$  can result from the number theoretically simple values of quantum phases  $\exp(i2\pi/n_i)$  corresponding to polygons constructible using only ruler and compass. For instance, one could have  $n_a = 2 \times 3$  and  $n_b = 2 \times 3 \times 5$ .

### Connection with plasma electrolysis?

The burning of salt water involves also the production of  $O_2$  and  $H_2$  gases. Usually this happens in the electrolysis of water [D2]. The arrangement involves typically electrolyte consisting of water plus *NaOH* or *KOH* present also now but anode, cathode and electronic current absent. The proposed mechanism of electrolysis involving cold nuclear reactions however allows the splitting of water molecules to  $H_2$  and  $O_2$  even without these prerequisites.

The thermal radiation from the plasma created in the process has temperature about 1500 C which correspond to energy about .17 eV: this is not enough for splitting of bonds with energy .5 eV. The temperature in salt water could be however considerably higher.

The presence of visible light suggests that plasma phase is created as in plasma electrolysis. Dark nuclear reactions would provide the energy leading to ionization of hydrogen atoms and subsequent transformation of the electronic charge to that of charged color bonds in protonic strings. This in turn would increase the rate of cold nuclear reactions and the liberated energy would ionize more hydrogen atoms so that a positive feedback loop would result.

Cold nuclear reactions should provide the energy transforming hydrogen bonds to dark bonds with energy scaled down by a factor of about  $2^{-6}$  from say 8 eV to .125 eV if  $T = 1500C$  is accepted as temperature of water. If Planck constant is scaled up by the factor  $r = 180$  suggested by the interpretation in terms of microwave heating, the scaling of the Planck constant would reduce the energy of *OH* bonds to about .04 eV, which happens to be slightly below the energy assignable to the cell membrane resting potential. The scaling of the size of nuclear space-time sheets of  $D$  by factor  $r = 180$  is consistent with the length of color bonds of order  $10^{-12}$  m. The role of microwave

heating would be to preserve this temperature so that the electrolysis of water can continue. Note that the energy from cold nuclear reactions could partially escape as dark photons.

There are some questions to be answered.

1. Are the radio wave photons dark or does water - which is a very special kind of liquid - induce the transformation of ordinary radio wave photons to dark photons by fusing 180 radio wave massless extremals (MEs) to single ME. Does this transformation occur for all frequencies? This kind of transformation might play a key role in transforming ordinary EEG photons to dark photons and partially explain the special role of water in living systems.
2. Why the radiation does not induce a spontaneous combustion of living matter which also contains  $Na^+$  and other ions. A possible reason is that  $\hbar$  corresponds to Planck constant of dark  $Li$  which is much higher in living water. Hence the energies of dark photons do not induce microwave heating.
3. The visible light generated in the process has yellow color. The mundane explanation is that the introduction  $Na$  or its compounds into flame yields bright yellow color due to so called sodium D-lines [D25] at 588.9950 and 589.5924 nm emitted in transition from 3p to 3s level. Visible light could result as dark photons from the dropping of dark protons from dark space-time sheets of size at least atomic size to larger dark space-time sheets or to ordinary space-time sheets of same size and de-cohere to ordinary light. In many-sheeted space-time particles topologically condense at all space-time sheets having projection to given region of space-time so that this option makes sense only near the boundaries of space-time sheet of a given system.

Yellow light corresponds roughly to the rather narrow energy range .96-2.1 eV (.59–.63  $\mu m$ ). The metabolic quanta correspond to jumps to space-time sheets of increasing size give rise to the fractal series  $E/eV = 2 \times (1 - 2^{-n})$  for transitions  $k = 135 \rightarrow 135 + n$ ,  $n = 1, 2, \dots$  [K49]. For  $n = 3, 4, 5$  the lines have energies 1.74, 1.87, 1.93 eV and are in the visible red ( $\lambda/\mu m = .71, .66, .64$ ). For  $n > 5$  the color is yellow. In Kanarev's experiments the color is red which would mean the dominance of  $n < 6$  lines: this color is regarded as a signature of the plasma electrolysis. In the burning of salt water the light is yellow [D1], which allows to consider the possibility that yellow light is partially due to  $n > 5$  lines. Yellow color could also result from the dropping  $k = 134 \rightarrow 135$  ( $n = 1$ ).

#### 7.4.2 Could q-Laguerre equation relate to the claimed fractionation of the principal quantum number for hydrogen atom?

The so called hydrino atom concept of Randell Mills [D23] represents one of the notions related to free energy research not taken seriously by the community of university physicists. What is claimed that hydrogen atom can exist as scaled down variants for which binding energies are much higher than usually due to the large Coulomb energy. The claim is that the quantum number  $n$  having integer values  $n = 0, 1, 2, 3, \dots$  and characterizing partially the energy levels of the hydrogen atom can have also inverse integer values  $n = 1/2, 1/3, \dots$ . The claim of Mills is that the laboratory BlackLight Inc. led by him can produce a plasma state in which transitions to these exotic bound states can occur and liberate as a by-product usable energy.

The National Aeronautic and Space Administration has dispatched mechanical engineering professor Anthony Marchese from Rowan University to BlackLight's labs in Cranbury, NJ, to investigate whether energy plasmas-hot, charged gases- produced by Mills might be harnessed for a new generation of rockets. Marchese reported back to his sponsor, the NASA Institute for Advanced Concepts, that indeed the plasma was so far unexplainably energetic. An article about the findings of Mills and collaborators have been accepted for publication in Journal of Applied Physics so that there are reasons to take seriously the experimental findings of Mills and collaborators even if one does not take seriously the theoretical explanations.

The fractionized principal quantum number  $n$  claimed by Mills [D23] is reported to have at least the values  $n = 1/k$ ,  $k = 2, 3, 4, 5, 6, 7, 10$ . First explanation would be in terms of Plack constant having also values smaller than  $\hbar_0$  possible if singular factor spaces of causal diamond CD and  $CP_2$  are allowed. q-Deformations of ordinary quantum mechanics are suggested strongly by the

hierarchy of Jones inclusion associated with the hyper-finite factor of type  $II_1$  about which WCW spinors are a basic example. This motivates the attempt to understand the claimed fractionization in terms of  $q$ -analog of hydrogen atom. The safest interpretation for them would be as states which can exist in ordinary imbedding space (and also in other branches)

The Laguerre polynomials appearing in the solution of Schrödinger equation for hydrogen atom possess quantum variant, so called  $q$ -Laguerre polynomials [A9], and one might hope that they would allow to realize this semiclassical picture at the level of solutions of appropriately modified Schrödinger equation and perhaps also resolve the difficulty associated with  $n = 1/2$ . Unfortunately, the polynomials discussed in [A9] correspond to  $0 < q \leq 1$  rather than complex values of  $q = \exp(i\pi/m)$  on circle and the extrapolation of the formulas for energy eigenvalues gives complex energies.

#### $q$ -Laguerre equation for $q = \exp(i\pi/m)$

The most obvious modification of the Laguerre equation for  $S$ -wave sates (which are the most interesting by semiclassical argument) in the complex case is based on the replacement

$$\begin{aligned} \partial_x &\rightarrow \frac{1}{2}(\partial_x^q + \partial_{\bar{x}}^q) \\ \partial_x^q f &= \frac{f(qx) - f(x)}{(q-1)x}, \\ q &= \exp(i\pi/m) \end{aligned} \quad (7.4.1)$$

to guarantee hermiticity. When applied to the Laguerre equation

$$x \frac{d^2 L_n}{dx^2} + (1-x) \frac{dL_n}{dx} = nL_n, \quad (7.4.2)$$

and expanding  $L_n$  into Taylor series

$$L_n(x) = \sum_{n \geq 0} l_n x^n, \quad (7.4.3)$$

one obtains difference equation

$$\begin{aligned} a_{n+1} l_{n+1} + b_n l_n &= 0, \\ a_{n+1} &= \frac{1}{4R_1^2} [R_{2n+1} - R_{2n} + 2R_{n+1}R_1 + 3R_1] + \frac{1}{2R_1} [R_{n+1} + R_1] \\ b_n &= \frac{R_n}{2R_1} - n^q + \frac{1}{2}, \\ R_n &= 2\cos[(n-1)\pi/m] - 2\cos[n\pi/m]. \end{aligned} \quad (7.4.4)$$

Here  $n^q$  is the fractionized principal quantum number determining the energy of the  $q$ -hydrogen atom. One cannot pose the difference equation on  $l_0$  since this together with the absence of negative powers of  $x$  would imply the vanishing of the entire solution. This is natural since for first order difference equations lowest term in the series should be chosen freely.

#### Polynomial solutions of $q$ -Laguerre equation

The condition that the solution reduces to a polynomial reads as

$$b_n = 0 \quad (7.4.5)$$

and gives

$$n^q) = \frac{1}{2} + \frac{R_n}{2R_1} , \quad (7.4.6)$$

For  $n = 1$  one has  $n^q) = 1$  so that the ground state energy is not affected. At the limit  $N \rightarrow \infty$  one obtains  $n^q) \rightarrow n$  so that spectrum reduces to that for hydrogen atom. The periodicity  $R_{n+2Nk} = R_n$  reflects the corresponding periodicity of the difference equation which suggests that only the values  $n \leq 2m - 1$  belong to the spectrum. Spectrum is actually symmetric with respect to the middle point  $[N/2]$  which suggests that only  $n < [m/2]$  corresponds to the physical spectrum. An analogous phenomenon occurs for representations of quantum groups [K9]. When  $m$  increases the spectrum approaches integer valued spectrum and one has  $n > 1$  so that no fractionization in the desired sense occurs for polynomial solutions.

### Non-polynomial solutions of q-Laquerre equation

One might hope that non-polynomial solutions associated with some fractional values of  $n^q)$  near to those claimed by Mills might be possible. Since the coefficients  $a_n$  and  $b_n$  are periodic, one can express the solution ansatz as

$$\begin{aligned} L_n(x) &= P_a^{2m)}(x) \sum_k a^k x^{2mk} = P_a^{2m)}(x) \frac{1}{1 - ax^{2m}} , \\ P_a^{2m)}(x) &= \sum_{k=0}^{2m-1} l_k x^k , \\ a &= \frac{l_{2m}}{l_0} , \end{aligned} \quad (7.4.7)$$

This solution behaves as  $1/x$  asymptotically but has pole at  $x_\infty = (1/a)^{1/2m}$  for  $a > 0$ .

The expression for  $l_{2m}/l_0 = a$  is

$$a = \prod_{k=1}^{2m} \frac{b_{2m-k}}{a_{2m-k+1}} . \quad (7.4.8)$$

This can be written more explicitly as

$$\begin{aligned} a &= (2R_1)^{2m} \prod_{k=1}^{2m} X_k , \\ X_k &= \frac{R_{2m-k} + (-2n^q) + 1}{R_{4m-2k+1} - R_{4m-2k} + 4R_{2m-k+1}R_1 + 2R_1^2 + 3R_1} , \\ R_n &= 2\cos[(n-1)\pi/m] - 2\cos[n\pi/m] . \end{aligned} \quad (7.4.9)$$

This formula is a specialization of a more general formula for  $n = 2m$  and resulting ratios  $l_n/l_0$  can be used to construct  $P_a^{2m)}$  with normalization  $P_a^{2m)}(0) = 1$ .

### Results of numerical calculations

Numerical calculations demonstrate following.

1. For odd values of  $m$  one has  $a < 0$  so that a a continuous spectrum of energies seems to result without any further conditions.
2. For even values of  $m$   $a$  has a positive sign so that a pole results.



For even value of  $m$  it could happen that the polynomial  $P_a^{2m}(x)$  has a compensating zero at  $x_\infty$  so that the solution would become square integrable. The condition for reads explicitly

$$P_a^{2m} \left( \left( \frac{1}{a} \right)^{\frac{1}{2m}} \right) = 0 . \tag{7.4.10}$$

If  $P_a^{2m}(x)$  has zeros there are hopes of finding energy eigen values satisfying the required conditions. Laguerre polynomials and also q-Laguerre polynomials must possess maximal number of real zeros by their orthogonality implied by the hermiticity of the difference equation defining them. This suggests that also  $P_a^{2m}(x)$  possesses them if  $a$  does not deviate too much from zero. Numerical calculations demonstrate that this is the case for  $n^q < 1$ .

For ordinary Laguerre polynomials the naive estimate for the position of the most distant zero in the units used is larger than  $n$  but not too much so. The naive expectation is that  $L_{2m}$  has largest zero somewhat above  $x = 2m$  and that same holds true a small deformation of  $L_{2m}$  considered now since the value of the parameter  $a$  is indeed very small for  $n^q < 1$ . The ratio  $x_\infty/2m$  is below .2 for  $m \leq 10$  so that this argument gives good hopes about zeros of desired kind.

One can check directly whether  $x_\infty$  is near to zero for the experimentally suggested candidates for  $n^q$ . The table below summarizes the results of numerical calculations.

1. The table gives the exact eigenvalues  $1/n_q$  with a 4-decimal accuracy and corresponding approximations  $1/n_{\simeq}^q = k$  for  $k = 3, \dots, 10$ . For a given value of  $m$  only single eigenvalue  $n^q < 1$  exists. If the observed anomalous spectral lines correspond to single electron transitions, the values of  $m$  for them must be different. The value of  $m$  for which  $n^q \simeq 1/k$  approximation is optimal is given with boldface. The value of  $k$  increases as  $m$  increases. The lowest value of  $m$  allowing the desired kind of zero of  $P^{2m}$  is  $m = 18$  and for  $k \in \{3, 10\}$  the allowed values are in range  $18, \dots, 38$ .
2.  $n^q = 1/2$  does not appear as an approximate eigenvalue so that for even values of  $m$  quantum calculation produces same disappointing result as the classical argument. Below it will be however found that  $n^q = 1/2$  is a universal eigenvalue for odd values of  $m$ .

m	$1/n_{\simeq}^q$	$1/n^q$	m	$1/n_{\simeq}^q$	$1/n^q$
<b>18</b>	<b>3</b>	2.7568	30	8	7.5762
<b>20</b>	<b>4</b>	3.6748	<b>32</b>	<b>8</b>	8.3086
22	5	4.5103	<b>34</b>	<b>9</b>	9.0342
<b>24</b>	<b>5</b>	5.3062	<b>36</b>	<b>10</b>	9.7529
<b>26</b>	<b>6</b>	6.0781	38	10	10.4668
<b>28</b>	<b>7</b>	6.8330			

Table3. The table gives the approximations  $1/n_{\simeq}^q = 1/k$  and corresponding exact values  $1/n^q$  in the range  $k = 3, \dots, 10$  for which  $P_a^{2m}(x_\infty)$  is nearest to zero. The corresponding values of  $m = 2k$  vary in the range,  $k = 18, \dots, 38$ . For odd values of  $m$  the value of the parameter  $a$  is negative so that there is no pole. Boldface marks for the best approximation by  $1/n_{\simeq}^q = k$ .

**How to obtain  $n^q = 1/2$  state?**

For odd values of  $m$  the quantization recipe fails and physical intuition tells that there must be some manner to carry out quantization also now. The following observations give a hunch about the desired condition.

1. For the representations of quantum groups only the first  $m$  spins are realized [K9] . This suggests that there should exist a symmetry relating the coefficients  $l_n$  and  $l_{n+m}$  and implying  $n^q = 1/2$  for odd values of  $m$ . This symmetry would remove also the double degeneracy associated with the almost integer eigenvalues of  $n^q$ . Also other fractional states are expected on basis of physical intuition.

2. For  $n^q) = 1/2$  the recursion formula for the coefficients  $l_n$  involves only the coefficients  $R_m$ .
3. The coefficients  $R_k$  have symmetries  $R_k = R_{k+2m}$  and  $R_{k+m} = -R_m$ .

There is indeed this kind of symmetry. From the formula

$$\begin{aligned} \frac{l_n}{l_0} &= (2R_1)^n \prod_{k=1}^n X_k , \\ X_k &= \frac{R_{n-k} + (-2n^q) + 1)R_1}{[R_{2n-2k+1} - R_{n-2k} + 4R_{n-k+1}R_1 + 2R_1^2 + 3R_1]} \end{aligned} \quad (7.4.11)$$

one finds that for  $n^q) = 1/2$  the formula giving  $l_{n+m}$  in terms of  $l_n$  changes sign when  $n$  increases by one unit

$$\begin{aligned} A_{n+1} &= (-1)^m A_n , \\ A_n &= \prod_{k=1}^m \frac{b_{n+m-k}}{a_{n+m-k+1}} = \prod_{k=1}^m (2R_1)^m \prod_{k=1}^m X_{k+n} . \end{aligned} \quad (7.4.12)$$

The change of sign is essentially due to the symmetries  $a_{n+m} = -a_n$  and  $b_{n+m} = b_n$ . This means that the action of translations on  $A_n$  in the space of indices  $n$  are represented by group  $Z_2$ .

This symmetry implies  $a = l_{2m}/l_0 = -(l_m)(l_0)^2$  so that for  $n^q) = 1/2$  the polynomial in question has a special form

$$\begin{aligned} P_a^{2m)} &= P_a^m)(1 - Ax^m) , \\ A &= A_0 . \end{aligned} \quad (7.4.13)$$

The relationship  $a = -A^2$  implies that the solution reduces to a form containing the product of  $m^{th}$  (rather than  $(2m)^{th}$ ) order polynomial with a geometric series in  $x^m$  (rather than  $x^{2m}$ ):

$$L_{1/2}(x) = \frac{P_a^m)(x)}{1 + Ax^m} . \quad (7.4.14)$$

Hence the  $n$  first terms indeed determine the solution completely. For even values of  $m$  one obtains similar result for  $n^q) = 1/2$  but now  $A$  is negative so that the solution is excluded. This result also motivates the hypothesis that for the counterparts of ordinary solutions of Laguerre equation sum (even  $m$ ) or difference (odd  $m$ ) of solutions corresponding to  $n$  and  $2m - n$  must be formed to remove the non-physical degeneracy.

This argument does not exclude the possibility that there are also other fractional values of  $n$  allowing this kind of symmetry. The condition for symmetry would read as

$$\begin{aligned} \prod_{k=1}^m (R_k + \epsilon R_1) &= \prod_{k=1}^m (R_k - \epsilon R_1) , \\ \epsilon &= (2n^q) - 1 . \end{aligned} \quad (7.4.15)$$

The condition states that the odd part of the polynomial in question vanishes. Both  $\epsilon$  and  $-\epsilon$  solutions so that  $n^q)$  and  $1 - n^q)$  are solutions. If one requires that the condition holds true for all values of  $m$  then the comparison of constant terms in these polynomials allows to conclude that  $\epsilon = 0$  is the only universal solution. Since  $\epsilon$  is free parameter, it is clear that the  $m$ :th order polynomial in question has at most  $m$  solutions which could correspond to other fractionized eigenvalues expected to be present on basis of physical intuition.

This picture generalizes also to the case of even  $n$  so that also now solutions of the form of Eq. 7.4.14 are possible. In this case the condition is

$$\prod_{k=1}^m (R_k + \epsilon R_1) = - \prod_{k=1}^m (R_k - \epsilon R_1) . \quad (7.4.16)$$

Obviously  $\epsilon = 0$  and thus  $n = 1/2$  fails to be a solution to the eigenvalue equation in this case. Also now one has the spectral symmetry  $n_{\pm} = 1/2 \pm \epsilon$ .

The symmetry  $R_n = (-1)^m R_{n+m-1} = (-1)^m R_{n-m-1} = (-1)^m R_{m-n+1}$  can be applied to show that the polynomials associated with  $\epsilon$  and  $-\epsilon$  contain both the terms  $R_n - \epsilon$  and  $R_n + \epsilon$  as factors except for odd  $m$  for  $n = (m+1)/2$ . Hence the values of  $n$  can be written for even values of  $m$  as

$$n^q(n) = \frac{1}{2} \pm \frac{R_n}{2R_1} , \quad n = 1, \dots, \frac{m}{2} , \quad (7.4.17)$$

and for odd values of  $m$  as

$$\begin{aligned} n_{\pm}^q(n) &= \frac{1}{2} \pm \frac{R_n}{2R_1} , \quad n = 1, \dots, \frac{m+1}{2} - 1 , \\ n^q &= 1/2 . \end{aligned} \quad (7.4.18)$$

Plus sign obviously corresponds to the solutions which reduce to polynomials and to  $n^q \simeq n$  for large  $m$ . The explicit expression for  $n^q$  reads as

$$n_{\pm}^q(n) = \frac{1}{2} \pm \frac{(\sin^2(\pi(n-1)/2m) - \sin^2(\pi n/2m))}{2\sin^2(\pi/2m)} . \quad (7.4.19)$$

At the limit of large  $m$  one has

$$n_{+}^q(n) \simeq n , \quad n_{-}^q(n) \simeq 1 - n . \quad (7.4.20)$$

so that the fractionization  $n \simeq 1/k$  claimed by Mills is not obtained at this limit. The minimum for  $|n^q|$  satisfies  $|n^q| < 1$  and its smallest value  $|n^q| = .7071$  corresponds to  $m = 4$ . Thus these zeros cannot correspond to  $n^q \simeq 1/k$  yielded by the numerical computation for even values of  $m$  based on the requirement that the zero of  $P^{2m}$  cancels the pole of the geometric series.

### Some comments

Some closing comments are in order.

1. An open question is whether there are also zeros  $|n^q| > 1$  satisfying  $P_a^{2m}((1/a)^{1/2m}) = 0$  for even values of  $m$ .
2. The treatment above is not completely general since only s-waves are discussed. The generalization is however a rather trivial replacement  $(1-x)d/dx \rightarrow (l+1-x)d/dx$  in the Laguerre equation to get associated Laguerre equation. This modifies only the formula for  $a_{n+1}$  in the recursion for  $l_n$  so that expression for  $n^q$ , which depends on  $b_n$ :s only, is not affected. Also the product of numerators in the formula for the parameter  $a = l_{2m}/l_0$  remains invariant so that the general spectrum has the spectral symmetry  $n^q \rightarrow 1 - n^q$ . The only change to the spectrum occurs for even values of  $m$  and is due to the dependence of  $x_{\infty} = (1/a)^{1/2m}$  on  $l$  and can be understood in the semiclassical picture. It might happen that the value of  $l$  is modified to its  $q$  counterpart corresponding to q-Legendre functions.

3. The model could partially explain the findings of Mills and  $n^q \simeq 1/k$  for  $k > 2$  also fixes the value of corresponding  $m$  to a very high degree so that one would have direct experimental contact with generalized imbedding space, spectrum of Planck constants, and dark matter. The fact that the fractionization is only approximately correct suggests that the states in question could be possible for all sectors of imbedding space appear as intermediate states into sectors in which the spectrum of hydrogen atom is scaled by  $n_b/n_a = k = 2, 3, \dots$
4. The obvious question is whether q-counterparts of angular momentum eigenstates ( $idf_m/d\phi = mf_m$ ) are needed and whether they make sense. The basic idea of construction is that the phase transition changing  $\hbar$  does not involve any other modifications except fractionization of angular momentum eigenvalues and momentum eigenvalues having purely geometric origin. One can however ask whether it is possible to identify q-plane waves as ordinary plane waves. Using the definition  $L_z = 1/2(\partial_u^q + \partial_{\bar{u}}^q)$ ,  $u = \exp(i\phi)$ , one obtains  $f_n = \exp(in\phi)$  and eigenvalues as  $n^q = R_n/R_1 \rightarrow n$  for  $m \rightarrow \infty$ . Similar construction applies in the case of momentum components.

### 7.4.3 Comparison with the reports about biological transmutations

Kervran's book "Biological Transmutations" [C30] contains a surprisingly detailed summary about his work with biological transmutations and it is interesting to find whether the proposed model could explain the findings of Kervran. TGD suggests two general mechanisms.

1. The nuclear reactions involving dark  $Li$ ,  $C$ , and  $F$  predicted to be present in living matter.
2. Nuclear fusions made possible by a temporary transformation of ordinary nuclear space-time sheets to dark ones with much larger size so that Coulomb wall is reduced considerably. The nuclear reaction might proceed if it is energetically possible. Almost any reaction  $A + B \rightarrow C$  is possible via this mechanism unless the nuclei are not too heavy.

#### Fortuitous observations

In his childhood Kervran started to wonder why hens living in a limestone poor region containing thus very little calcium in ground and receiving no calcium in their nutrition could develop the calcium required by eggs and by their own bones. He noticed that hens had the habit of eating mica, which contains silicon. Later this led to the idea that  $Si$  could somehow transmute to  $Ca$  in living matter. In the proposed model this could correspond to fusion of  $Si(14, 14) + \mathbf{C(6, 6)} \rightarrow Ca(20, 20)$  which occurs spontaneously.

Second fortuitous observation were the mysterious  $CO$  poisonings by welders working in factory. After careful studies Kervran concluded that  $CO$  must be produced endogenously and proposed that the inhaled air which had been in contact with incandescent iron induces the transformation  $N_2 \rightarrow CO$  conserving both neutron and proton number. This transformation might be understood in TGD context if the nuclear space-time sheets are part of time in dark with much larger size so that a direct contact becomes possible for nuclear space-time sheets and Coulomb wall is reduced so that the reaction can proceed with some probability if energetically possible. The thermal energy received from hot iron might help to overcome the Coulomb barrier. The mass difference  $m(2N) - m(O) - m(C) = 10.45$  MeV allows this reaction to occur spontaneously.

#### Examples of various anomalies

Kervran discusses several plant anomalies. The ashes of plants growing in  $Si$  rich soil contain more  $Ca$  than they should: this transmutation has been already discussed. The ashes of a plant growing on  $Cu$  fibres contain no copper but 17 per cent of iron oxides in addition to other elements which could not have come from the rain water. The reaction  $Cu(58) + \mathbf{Li(3, 4)} \rightarrow Fe(26, 32) + \mathbf{C(6, 6)}$  would liberate energy of 11.5 MeV.

There are several mineral anomalies.

1. Dolomite rock is formed inside limestone rocks which would suggest the transmutation of  $Ca(20, 20)$  into  $Mg(12, 12)$ . The nuclear reaction  $Ca(20, 20) + \mathbf{Li(3, 4)} \rightarrow Mg(12, 12) +$

$Na(11, 12)$  would liberate energy of 3.46 MeV.  $Ca$  emerges from  $Si$  in soil and in what Kervran refers to a "sickness of stone". The candidate reaction has been already discussed.

- Graphite is found in siliceous rocks. Kervran proposes the reaction  $Si \rightarrow C + O$ .  $m(Si) - m(C) - M(O) = -16.798$  MeV does not allow this reaction to proceed spontaneously but the reaction  $Si + Li \rightarrow C + Na$  liberates the energy 2.8880 MeV.
- Kervran mentions the reaction  $O + O \rightarrow S$  as a manner to produce sulphur from oxygen. This reaction is obviously energetically favored.

Kervran discusses the transmutations  $Na \rightarrow K$  and  $Na \rightarrow Ca$  occurring also in plasma electrolysis and explained by TGD based model. Further transmutations are  $Na \rightarrow Mg$  and  $Mg \rightarrow Ca$ .  $Na \rightarrow Mg$  could correspond to the reaction  $Na(11, 12) + Li(3, 2) \rightarrow Mg(12, 12) + He(2, 2)$  favored by the high binding energy per nucleon for  ${}^4He$  (7.072 MeV).  $Mg \rightarrow Ca$  would correspond to the reaction  $Mg + O \rightarrow Ca$ , which obviously liberates energy.

#### 7.4.4 Are the abundances of heavier elements determined by cold fusion in interstellar medium?

According to the standard model, elements not heavier than  $Li$  were created in Big Bang. Heavier elements were produced in stars by nuclear fusion and ended up to the interstellar space in supernova explosions and were gradually enriched in this process. Lithium problem forces to take this theoretical framework with a grain of salt.

The work of Kervran [C30] suggests that cold nuclear reactions are occurring with considerable rates, not only in living matter but also in non-organic matter. Kervran indeed proposes that also the abundances of elements at Earth and planets are to high degree determined by nuclear transmutations and discusses some examples. For instance, new mechanisms for generation of  $O$  and  $Si$  would change dramatically the existing views about evolution of planets and prebiotic evolution of Earth.

#### Where did the Lithium go?

Ulla - one of the commentators in my blog - sent an interesting link concerning Lithium problem to an article by Elisabetta Caffau et al titled "An extremely primitive halo star" [E16].

What has been found is a star which is extremely poor on metallic elements: ("metallic" refers to elements heavier than  $Li$ ). The mystery is that not only elements heavier than  $Li$  but also  $Li$  itself, whose average abundance is believed to be determined by cosmological rather than stellar nucleosynthesis, is very scarcely present in these stars.

This finding can be coupled with too other observations about anomalies in  $Li$  abundance.

- The average abundance of  $Li$  in Cosmos is lower than predicted by standard cosmology by a factor between 2 and 3 [E9].
- Also Sun has too low  $Li$  abundance [E8].

Authors think that some process could have created very high temperature destroying the  $Li$  in this kind of stars: maybe dark matter annihilation might have caused this. This looks rather artificial to me and would not explain too low  $Li$  abundance for other stars and for interstellar medium.

The transformation of  $Li$  to dark matter (ordinary Lithium in a phase with larger value of Planck constant) would mean its effective disappearance. This process would have occurred both in interstellar medium and in stars so that all three  $Li$  problems would be solved at once. Many question marks remain. What about the rate for the phase transition to dark matter? Also lighter elements should be able to transform to dark form. Why the cosmological abundances for them are however essentially those predicted by the standard model of primordial nucleosynthesis? Is the reason that  $Li$  their fusion to  $Li$  was much faster than transformation to dark matter during primordial nucleosynthesis whereas  $Li$  fused very slowly and had time to transform to dark  $Li$ ?

$Li$  problem would rather sharply distinguish between two very different views about dark matter: dark matter as some exotic elementary particles on one hand and dark matter as phases of ordinary matter implied by generalization of quantum theory on the other hand.

### Are heavier nuclei produced in the interstellar space?

TGD based model is consistent with the findings of Kervran and encourages to consider a simple model for the generation of heavier elements in interstellar medium. The assumptions are following.

1. Dark nuclei  $X(3k, n)$ , that is nuclear strings of form  $Li(3, n)$ ,  $C(6, n)$ ,  $F(9, n)$ ,  $Mg(12, n)$ ,  $P(15, n)$ ,  $A(18, n)$ , etc..., form as a fusion of  $Li$  strings.  $n = Z$  is the most plausible value of  $n$ . There is also  ${}^4He$  present but as a noble gas it need not play an important role in condensed matter phase (say interstellar dust). The presence of water necessitates that of  $Li(3, n)$  if one accepts the proposed model as such.
2. The resulting nuclei are in general stable against spontaneous fission by energy conservation. The binding energy of  $He(2, 2)$  is however exceptionally high so that alpha decay can occur in dark nuclear reactions between  $X(3k, n)$  allowed by the considerable reduction of the Coulomb wall. The induced fissions  $X(3k, n) \rightarrow X(3k - 2, n - 2) + He(2, 2)$  produces nuclei with atomic number  $Z \bmod 3 = 1$  such as  $Be(4, 5)$ ,  $N(7, 7)$ ,  $Ne(10, 10)$ ,  $Al(13, 14)$ ,  $S(16, 16)$ ,  $K(19, 20)$ ,... Similar nuclear reactions make possible a further alpha decay of  $Z \bmod 3 = 1$  nuclei to give nuclei with  $Z \bmod 2$  such as  $B(5, 6)$ ,  $O(8, 8)$ ,  $Na(11, 12)$ ,  $Si(14, 14)$ ,  $Cl(17, 18)$ ,  $Ca(20, 20)$ ,... so that most stable isotopes of light nuclei could result in these fissions.
3. The dark nuclear fusions of already existing nuclei can create also heavier  $Fe$ . Only the gradual decrease of the binding energy per nucleon for nuclei heavier than  $Fe$  poses restrictions on this process.

The table below allows the reader to build a more concrete view about how the heavier nuclei might be generated via the proposed mechanisms.

H(1,0)							He(2,2)
Li(3,4)	Be(4,5)	B(5,6)	C(6,6)	N(7,7)	O(8,8)	F(9,10)	Ne(10,10)
Na(11,12)	Mg(12,12)	Al(13,14)	Si(14,14)	P(15,16)	S(16,16)	Cl(17,18)	A(18,22)
K(19,20)	Ca(20,20)						

Table 4. The table gives the most abundant isotopes of stable nuclei.

### The abundances of nuclei in interstellar space should not depend on time

The basic prediction of TGD inspired model is that the abundances of the nuclei in the interstellar space should not depend on time if the rates are so high that equilibrium situation is reached rapidly. The  $\hbar$  increasing phase transformation of the nuclear space-time sheet determines the time scale in which equilibrium sets on. Standard model makes different prediction: the abundances of the heavier nuclei should gradually increase as the nuclei are repeatedly re-processed in stars and blown out to the interstellar space in super-nova explosion.

Amazingly, there is empirical support for this highly non-trivial prediction [E24]. Quite surprisingly, the 25 measured elemental abundances (elements up to  $Sn(50, 70)$  (tin) and  $Pb(82, 124)$  (lead)) of a 12 billion years old galaxy turned out to be very nearly the same as those for Sun. For instance, oxygen abundance was 1/3 from that from that estimated for Sun. Standard model would predict that the abundances should be .01-.1 from that for Sun as measured for stars in our galaxy. The conjecture was that there must be some unknown law guaranteeing that the distribution of stars of various masses is time independent. The alternative conclusion would be that heavier elements are created mostly in interstellar gas and dust.

### Could also "ordinary" nuclei consist of protons and negatively charged color bonds?

The model would strongly suggest that also ordinary stable nuclei consist of protons with proton and negatively charged color bond behaving effectively like neutron. Note however that I have also consider the possibility that neutron halo consists of protons connected by negatively charged color bonds to main nucleus. The smaller mass of proton would favor it as a fundamental building block of nucleus and negatively charged color bonds would be a natural manner to minimize Coulomb energy. The fact that neutron does not suffer a beta decay to proton in nuclear environment provided by stable nuclei would also find an explanation.

1. Ordinary shell model of nucleus would make sense in length scales in which proton plus negatively charged color bond looks like neutron.
2. The strictly nucleonic strong nuclear isospin is not vanishing for the ground state nuclei if all nucleons are protons. This assumption of the nuclear string model is crucial for quantum criticality since it implies that binding energies are not changed in the scaling of  $\hbar$  if the length of the color bonds is not changed. The quarks of charged color bond however give rise to a compensating strong isospin and color bond plus proton behaves in a good approximation like neutron.
3. Beta decays might pose a problem for this model. The electrons resulting in beta decays of this kind nuclei consisting of protons should come from the beta decay of the d-quark neutralizing negatively charged color bond. The nuclei generated in high energy nuclear reactions would presumably contain genuine neutrons and suffer beta decay in which  $d$  quark is nucleonic quark. The question is whether how much the rates for these two kinds of beta decays differ and whether existing facts about beta decays could kill the model.

## 7.5 Cold fusion and sonoluminescence

### 7.5.1 Basic ideas about cold fusion

The basic prediction of TGD is a hierarchy of fractally scaled variants of QCD like theories and that color dynamics is fundamental even for our sensory qualia (visual colors identified as increments of color quantum numbers in quantum jump). The model for ORMEs suggest that exotic protons obey QCD like theory in the size scale of atom. If this identification is correct, QCD like dynamics might be studied some day experimentally in atomic or even macroscopic length scales of order cell size and there would be no need for ultra expensive accelerators!

#### What makes possible cold fusion?

I have proposed that cold fusion might be based on Trojan horse mechanism in which incoming and target nuclei feed their em gauge fluxes to different space-time sheets so that electromagnetic Coulomb wall disappears [K71]. If part of Palladium nuclei are "partially dark", this is achieved. Another mechanism could be the de-localization of protons to a larger volume than nuclear volume induced by the increase of  $h_{eff}$  meaning that reaction environment would differ dramatically from that appearing in the usual nuclear reactions and the standard objections against cold fusion would not apply anymore [K71]: this de-localization could correspond to the darkness of electromagnetic and perhaps also electroweak field bodies of protons.

A third proposal is perhaps the most elegant and relies on the nuclear string model [L3] predicting a large number of exotic nuclei obtained by allowing the color bonds connecting nucleons to have all possible em charges 1, 0, 1. Many ordinary heavy nuclei would be exotic in the sense that some protons would correspond to protons plus negatively charged color bonds. The exchange of an exotic weak boson between  $D$  and  $Pd$  nuclei transforming  $D$  nuclei to exotic neutral  $D$  nuclei would occur. The range of the exotic weak interaction correspond to atomic length scale meaning that it behaves as massless particle below this length scale. For instance,  $W$  boson could be  $r = 2^{24}$  dark variant of  $k = 113$  weak boson for which the dark variant of p-adic scale would correspond to the atomic scale  $k = 137$  but also other options are possible.

#### How standard objections against cold fusion can be circumvented?

The following arguments against cold fusion are from an excellent review article by Storms [C40].

1. Coulomb wall requires an application of higher energy. Now electromagnetic Coulomb wall disappears in both models.
2. If a nuclear reaction should occur, the immediate release of energy can not be communicated to the lattice in the time available. In the recent case the time scale is however multiplied by the factor  $r = n_a$  and the situation obviously changes. For  $n_a = 2^{24}$  the time scale

corresponding to MeV energy becomes that corresponding to keV energy which is atomic time scale.

3. When such an energy is released under normal conditions, energetic particles are emitted along with various kinds of radiation, only a few of which are seen by various CANR (Chemically Assisted Nuclear Reactions) studies. In addition, gamma emission must accompany helium, and production of neutrons and tritium, in equal amounts, must result from any fusion reaction. None of these conditions is observed during the claimed CANR effect, no matter how carefully or how often they have been sought. The large value of  $\hbar(M^4)$  implying large Compton lengths for protons making possible geometric coupling of gamma rays to condensed matter would imply that gamma rays do not leave the system. If only protons form the quantum coherent state then fusion reactions do not involve the protons of the cathode at all and production of  ${}^3\text{He}$  and thus of neutrons in the fusion of  $D$  and exotic  $D$ .
4. The claimed nuclear transmutation reactions (reported to occur also in living matter [C29] ) are very difficult to understand in standard nuclear physics framework.
  - (a) The model of [K71] allows them since protons of different nuclei can re-arrange in many different manners when the dark matter state decays back to normal.
  - (b) Nuclear string model [L3] allows transmutations too. For instance, neutral exotic tritium produced in the reactions can fuse with  $Pd$  and other nuclei.
5. Many attempts to calculate fusion rates based on conventional models fail to support the claimed rates within PdD (Palladium-Deuterium). The atoms are simply too far apart. This objection also fails for obvious reasons.

### Mechanisms of cold fusion

In TGD framework exotic nuclei are needed to explain the selection rules which do not conform with standard nuclear physics. There are several options for what exotic nuclei could be.

1. Nuclei might be partially dark with some nucleons in dark state with Compton length of order atomic length scale.
2. Nuclei can also be exotic in the sense that some neutral color bonds have transformed to charged ones by exchange of dark W bosons effectively massless below atomic length scale. This could transform D nuclei to neutral ones and eliminate Coulomb wall. The presence of two oppositely charged bonds by (possibly dark) W exchange could give rise to a nucleus with same em charge as the original but different mass: presumably mass difference would be of order keV.
3. Also the emitted em radiation - say gamma rays - and particles - say protons or neutrons - could be dark and could remain undetected using standard means.

From this it is clear that it is easy to invent models consistent with observations: careful consideration of data might however allow to fix the model to a high degree. One can try to deduce a more detailed model for cold fusion from observations, which are discussed systematically in [C40] and in the references discussed therein.

1. A critical phenomenon is in question. The average  $D/Pd$  ratio must be in the interval (.85, .90). The current must be over-critical and must flow a time longer than a critical time. The effect occurs in a small fraction of samples.  $D$  at the surface of the cathode is found to be important and activity tends to concentrate in patches. The generation of fractures leads to the loss of the anomalous energy production. Even the shaking of the sample can have the same effect. The addition of even a small amount of  $H_2O$  to the electrolyte (protons to the cathode) stops the anomalous energy production.
  - (a) These findings are consistent with the view that patches correspond to a macroscopic quantum phase involving de-localized nuclear protons. The added ordinary protons and fractures could serve as a seed for a phase transition leading to the ordinary phase [K71].



- (b) An alternative interpretation is in terms of the formation of neutral exotic  $D$  and exotic  $Pd$  via exchange of exotic, possibly dark,  $W$  bosons massless below atomic length scale [L3].
2. When  $D_2O$  is used as an electrolyte, the process occurs when  $PdD$  acts as a cathode but does not seem to occur when it is used as anode. This suggests that the basic reaction is between the ordinary deuterium  $D = pn$  of electrolyte with the exotic nucleus of the cathode. Denote by  $\hat{p}$  the exotic proton and by  $\hat{D} = n\hat{p}$  exotic deuterium at the cathode.

For ordinary nuclei fusions to tritium and  ${}^3He$  occur with approximately identical rates. The first reaction produces neutron and  ${}^3He$  via  $D + D \rightarrow n + {}^3He$ , whereas second reaction produces proton and tritium by  ${}^3H$  via  $D + D \rightarrow p + {}^3H$ . The prediction is that one neutron per each tritium nucleus should be produced. Tritium can be observed by its beta decay to  ${}^3He$  and neutron flux is several orders of magnitude smaller than tritium flux as found for instance by Tadahiko Mizuno and his collaborators (Mizuno describes the experimental process leading to this discovery in his book [C22]). Hence the reaction producing  ${}^3He$  cannot occur significantly in cold fusion which means a conflict with the basic predictions of the standard nuclear physics.

- (a) The explanation discussed in [K71] does not involve exotic nuclei with charged color bonds. The assumption is that the proton in the target deuterium  $\hat{D}$  is in the exotic state with large Compton length and the production of  ${}^3He$  occurs very slowly since  $\hat{p}$  and  $p$  correspond to different space-time sheets. Since neutrons and the proton of the  $D$  from the electrolyte are in the ordinary state, Coulomb barrier is absent and tritium production can occur. The mechanism also explains why the cold fusion producing  ${}^3He$  and neutrons does not occur using water instead of heavy water.
- (b) Nuclear string model [L3] model with charged color bonds predicts that only neutral exotic tritium is produced considerably when incoming deuterium interacts with neutral exotic deuterium in the target. This requires that in target  $D$  nuclei exchange large  $\hbar$   $W$  boson with electron or  $Pd$  or other  $D$  nucleus. In the latter case the outcome is two exotic nuclei looking chemically like di-neutron and  ${}^3He$ .
3. The production of  ${}^4He$  has been reported although the characteristic gamma rays have not been detected.
- (a)  ${}^4He$  can be produced in reactions such as  $D + \hat{D} \rightarrow {}^4He$  or its exotic counterpart in the model of [K71].
- (b) Nuclear string model [K71] does not allow direct production of  ${}^4He$  in D-D collisions.
4. Also more complex reactions between  $D$  and  $Pd$  for which protons are in exotic state, can occur. These can lead to the reactions transforming the nuclear charge of  $Pd$  and thus to nuclear transmutations.

Both models allow nuclear transmutations. In nuclear string model [K71] the resulting exotic tritium can fuse with  $Pd$  and other nuclei and produce nuclear transmutations.

The reported occurrence of nuclear transmutation such as  ${}^{23}Na + {}^{16}O \rightarrow {}^{39}K$  in living matter [C29] allowing growing cells to regenerate elements K, Mg, Ca, or Fe, could be understood in nuclear string model if also neutral exotic charge states are possible for nuclei in living matter. The experimental signature for the exotic ions would be cyclotron energy spectrum containing besides the standard lines also lines with ions with anomalous mass number. This could be seen as a splitting of lines. For instance, exotic variants of ions such  $Na^+$ ,  $K^+$ ,  $Cl^-$ ,  $Ca^{++}$  with anomalous mass numbers should exist. It would be easy to mis-interpret the situation unless the actual strength of the magnetic field is not checked.

5. Gamma rays, which should be produced in most nuclear reactions such as  ${}^4He$  production to guarantee momentum conservation are not observed.

- (a) The explanation of the model of [K71] is that the recoil momentum goes to the macroscopic quantum phase and eventually heats the electrolyte system. This provides obviously the mechanism by which the liberated nuclear energy is transferred to the electrolyte difficult to imagine in standard nuclear physics framework. The emitted gamma rays could be also dark and observed only if they transform to ordinary ones.
  - (b) In nuclear string model [L3]  ${}^4\text{He}$  is not produced at all.
6. Both models explain why neutrons are not produced in amounts consistent with the anomalous energy production. The addition of water to the electrolyte is however reported to induce neutron bursts.
- (a) In the model of [K71] (no charged color bonds) a possible mechanism is the production of neutrons in the phase transition  $\hat{p} \rightarrow p$ .  $\hat{D} \rightarrow p + n$  could occur as the proton contracts back to the ordinary size in such a manner that it misses the neutron. This however requires energy of 2.23 MeV if the rest masses of  $\hat{D}$  and  $D$  are same. Also  $\hat{D} + \hat{D} \rightarrow n + {}^3\text{He}$  could be induced by the phase transition to ordinary matter when  $\hat{p}$  transformed to  $p$  does not combine with its previous neutron partner to form  $D$  but recombines with  $\hat{D}$  to form  ${}^3\hat{\text{He}} \rightarrow {}^3\text{He}$  so that a free neutron is left.
  - (b) Nuclear string model [L3] would suggest that the collisions of protons of water with exotic neutral  $D$  with negatively charged color bond produce neutron and ordinary  $D$ . This requires the transformation of negatively charged color bond between p and n of target  $D$  to a neutral color bond between incoming p and neutron of target.

A cautious conclusion is that nuclear string model with exotic color bonds and dark weak bosons is the more natural option. Also dark protons suggested strongly by the model for the dark portion of water can be considered but partial darkness of nuclei is perhaps an artificial idea. Note that all nuclei might appear as dark variants with size scale of molecules and analogous to folded proteins. This intriguing similarity creates the question whether the physics of linear biomolecules mimics nuclear physics and whether dark nuclei are involved with this mimicry natural in the fractal Universe of TGD.

### 7.5.2 Does Rossi's reactor give rise to cold fusion?

Lubos Motl has been raging several times about the cold fusion gadget of Andrea Rossi and I decided to write the following response as he returned to the topic again. The claim of Rossi and physicist Fogardi [C24] is that the cold fusion reaction of H and Ni producing Cu takes place in the presence of some "additives" (Palladium catalyst as in many cold fusion experiments gathering at its surface Ni?).

#### Objections claiming that the evaporation of water does not actually take place

Lubos Motl of course "knows" before hand that the gadget cannot work: Coulomb barrier. Since Lubos is true believer in naive text book wisdom, he simply refuses to consider the possibility that the physics that we learned during student days might not be quite right. Personally I do not believe or disbelieve cold fusion: I just take it seriously as any person calling himself scientist should do. I have been developing for more than 15 years ideas about possible explanation of cold fusion in TGD framework. The most convincing idea is that large value of Planck constant associated with nuclei could be involved scaling up the range of weak interactions from  $10^{-17}$  meters to atomic size scale and also scaling up the size of nucleus to atomic size scale so that nucleus and even quarks would like constant charge densities instead of point like charge. Therefore Coulomb potential would be smoothed and the wall would become much lower (see this and this) [K71, L3].

One must say in honor of Lubos that at this time he had detailed arguments about what goes wrong with the reactor of Rossi: this is in complete contrast with the usual arguments of skeptics which as a rule purposefully avoid saying anything about the actual content and concentrate on ridiculing the target. The reason is of course that standard skeptic is just a soldier who has got the list of targets to be destroyed and as a good soldier does his best to achieve the goal. Thinking

is not what a good soldier is expected to do since the professors in the consultive board take care of this and give orders to those doing the dirty job.

As a theoretician I have learned the standard arguments used to debunk TGD: logic is circular, text is mere world salad, everything is just cheap numerology, too many self references, colleagues have not recognized my work, the work has not been published in respected journals, and so on. The additional killer arguments state that I have used certain words which are taboos and already for this reason am a complete crackpot. Examples of bad words are "water memory", "homeopathy", "cold fusion", "crop circles", "quantum biology", "quantum consciousness". There is of course no mention about the fact that I have always emphasized that I am skeptic, not a believer or disbeliever, and only make the question "What if..." and try to answer it in TGD framework. Intellectual honesty does not belong to the virtues of skeptics who are for modern science what jesuits were for the catholic church. Indeed, as Loyola said: the purpose sanctifies the deeds.

Lubos has real arguments but they suffer from the strong negative emotional background coloring so that one cannot be trust the rationality of the reasoning. The core of the arguments of Lubos is following.

1. The water inside reactor is heated to a temperature of 100.1 C. This is slightly above 100 C defining the nominal value of the boiling point temperature at normal pressure. The problem is that if the pressure is somewhat higher, the boiling point increases and the it could happen that the no evaporation of the water takes place. If this is the case, the whole energy fed into the reactor could go to the heating of the water. The input power is indeed somewhat higher than the power needed to heat the water to this temperature without boiling so that this possibility must be taken seriously and the question is whether the water is indeed evaporated.

Comments:

- (a) This looks really dangerous. Rossi uses water only as a passive agent gathering the energy assumed to be produced in the fusion of hydrogen and nickel to copper. This would allow to assume that the water fed in is at lower temperature and also the water at outlet is below boiling boiling. Just by measuring the temperature at the outlet one can check whether the outgoing water has temperature higher than it would be if all input energy goes to its heating.
  - (b) This is only one particular demonstration and it might be that there are other demonstrations in which the situation is this. As a matter fact, from an excellent video interview of Nobelist Brian Josephson one learns that there are also demonstrations in which water is only heated so that the argument of Lubos does not bite here. The gadget of Rossi is already used to heat university building. The reason why the evaporation is probably that this provides an effective manner to collect the produced energy. Also by reading the Nyteknik report [C24] one learns that the energy production is directly measured rather than being based on the assumption that evaporation occurs.
2. Is the water evaporated or not? This is the question posed by Lubos. The demonstration shows explicitly that there is a flow of vapor from the outlet. As Rossi explains there is some condensation. Lubos claims that the the flow of about 2 liters of vapor per second resulting from the evaporation 2 ml of water per second should produce much more dramatic visual effect. More vapor and with a faster flow velocity. Lubos claims that water just drops from the tube and part of it spontaneously evaporates. This is what Lubos wants to see and I have no doubt that he is seeing it. Strong belief can move mountains! Or at least can make possible the impression that they are moving!

Comments:

- (a) I do not see what Lubos sees but I am not able to tell how many liters of vapor per second comes out. Therefore the visual demonstration as such is not enough.
- (b) I wonder why Rossi has not added flow meter measuring the amount of vapor going through the tube. Second possibility is to allow the vapor condensate back to water in the tube by using heat exchanger. This would allow to calculate the energy gained

without making the assumption that all that comes out is vapor. It might be that in some experiments this is done.

To sum up, Lubos in his eagerness to debunk forgets that he is concentrating on single demonstration and forgetting other demonstrations altogether and also the published report [C24] to which his argument do not apply. I remain however skeptic (I mean real skeptic, the skepticism of Lubos and -sad to say- of quite too many skeptics- has nothing to do with a real skeptic attitude). Rossi should give information about the details of his invention and quantitative tests really measuring the heat produced should be carried out and published. Presumably the financial aspects related to the invention explain the secrecy in a situation in which patenting is difficult.

### Objections from nuclear physics

The reading of Rossi's paper and Wikipedia article led me to consider in more detail also various nuclear physics based objections against Rossi's reactor [C9]. Coulomb barrier, the lack of gamma rays, the lack of explanation for the origin of the extra energy, the lack of the expected radioactivity after fusing a proton with  $^{58}\text{Ni}$  (production of neutrino and positron in beta decay of  $^{59}\text{Cu}$ ), the unexplained occurrence of 11 per cent iron in the spent fuel, the 10 per cent copper in the spent fuel strangely having the same isotopic ratios as natural copper, and the lack of any unstable copper isotopes in the spent fuel as if the reactor only produced stable isotopes.

#### 1. *Could natural isotope ratios be determined by cold fusion?*

The presence of Cu in natural isotope ratios and the absence of unstable copper isotopes of course raise the question whether the copper is just added there. Also the presence of iron is strange. Could one have an alternative explanation for these strange co-incidences?

1. Whether unstable isotopes of Cu are present or not, depends on how fast  $^A\text{Cu}$ ,  $A < 63$  decays by neutron emission: this decay is expected to be fast since it proceeds by strong interactions. I do not know enough about the detailed decay rates to be able to say anything about this.
2. Why the isotope ratios would be the same as for naturally occurring copper isotopes? The simplest explanation would be that the fusion cascades of two stable Ni isotopes determine the ratio of naturally occurring Cu isotopes so that cold fusion would be responsible for their production. As a matter fact, TGD based model combined with what is claimed about bio-fusion led to the proposal that stable isotopes are produced in interstellar space by cold fusion and that this process might even dominate over the production in stellar interiors. This would solve among other things also the well-known Lithium problem. The implications of the ability to produce technologically important elements artificially at low temperatures are obvious.

#### 2. *Could standard nuclear physics view about cold fusion allow to overcome the objections?*

Consider now whether one could answer the objections in standard nuclear physics framework as a model for cold fusion processes.

1. By inspecting stable nuclides one learns that there are two fusion cascades. In the first cascade the isotopes of copper would be produced in a cascade starting from with  $^{58}\text{Ni} + n \rightarrow ^{59}\text{Cu}$  and stopping at  $^{63}\text{Cu}$ . All isotopes  $^A\text{Cu}$ ,  $A \in \{55, 62\}$  are unstable with lifetime shorter than one day. The second fusion cascade begins from  $^{63}\text{Ni}$  and stops at  $^{65}\text{Cu}$ .
2. The first cascade involves five cold fusions and 4 weak decays of Cu. Second cascade involves two cold fusions and one weak decay of Cu. The time taken by the cascade would be same if there is single slow step involved having same duration. The only candidates for the slow step would be the fusion of the stable Ni isotope with the neutron or the fusion producing the stable Cu isotope. If the fusion time is long and same irrespective of the neutron number of the stable isotope, one could understand the result. Of course, this kind of co-incidence does not look plausible.
3.  $^{A-5}\text{Fe}$  could be produced via alpha decay  $^A\text{Cu} \rightarrow ^{A-4}\text{Co} + \alpha$  followed by  $^{A-4}\text{Co} \rightarrow ^{A-5}\text{Fe} + p$ .

3. *Could TGD view about cold fusion allow to overcome the objections?*

The claimed absence of positrons from beta decays and the absence of gamma rays are strong objections against the assumption that standard nuclear physics is enough. In TGD framework it is possible to ask whether the postulated fusion cascades really occur and whether instead of it weak interactions in dark phase of nuclear matter with range of order atomic length scale are responsible for the process because weak bosons would be effectively massless below atomic length scale. For TGD inspired model of cold fusion see [tgdtheory.fi/public\\_html/pdfpool/padnucl.pdf](http://tgdtheory.fi/public_html/pdfpool/padnucl.pdf) and [tgdtheory.fi/public\\_html/paddark/paddark.html#nuclstring](http://tgdtheory.fi/public_html/paddark/paddark.html#nuclstring) [K71, L3].

1. The nuclear string model assumes that nucleons for nuclear strings with nucleons connected with color bonds having quark and antiquark at their ends. Color bonds could be also charged and this predicts new kind of internal structure for nuclei. Suppose that the space-time sheets mediating weak interactions between the color bonds and nucleons correspond to so large value of Planck constant that weak interaction length scale is scaled up to atomic length scale. The generalization of this hypothesis combined with the p-adic length scale hypothesis is actually standard piece of TGD inspired quantum biology ([tgdtheory.fi/public\\_html/paddark/paddark.html#darkforces](http://tgdtheory.fi/public_html/paddark/paddark.html#darkforces)) [K21].
2. The energy scale of the excitations of color bond excitations of the exotic nuclei would be measured in keVs. One could even consider the possibility that the energy liberated in cold fusion would correspond to this energy scale. In particular, the photons emitted would be in keV range corresponding to wavelength of order atomic length scale rather than in MeV range. This would resolve gamma ray objection.
3. Could the fusion process  $^{58}\text{Ni} + n$  actually lead to a generation of Ni nucleus  $^{59}\text{Ni}$  with one additional positively charged color bond? Could the fusion cascade only generate exotic Ni nuclei with charged color bonds, which would transform to stable Cu by internal dark W boson exchange transferring the positive charge of color bond to neutron and thus transforming it to neutron? This would not produce any positrons. This cascade might dominate over the one suggested by standard nuclear physics since the rates for beta decays could be much slower than the rate for direct generation of Ni isotopes with positively charged color bonds.
4. In this case also the direct alpha decay of Ni with charged color bond to Fe with charged color bond decaying to ordinary Fe by positron emission can be imagined besides the proposed mechanism producing Fe.
5. If one assumes that this process is responsible for producing the natural isotope ratios, one could overcome the basic objections against Rossi's reactor.

The presence of em radiation in keV range would be a testable basic signature of the new nuclear physics as also effects of X-ray irradiation on measured nuclear decay and reaction rates due to the fact that color bonds are excited. As a matter fact, it is known that X-ray bursts from Sun in keV range has effects on the measured nuclear decay rates and I have proposed that the proposed exotic nuclear physics in keV range is responsible for the effect. Quite generally, the excitations of color bonds would couple nuclear physics with atomic physics and I have proposed that the anomalies of water could involve classical  $Z^0$  force in atomic length scales. Also the low compressibility of condensed matter phase could involve classical  $Z^0$  force. The possible connections with sono-luminescence and claimed sonofusion are also obvious ([http://tgdtheory.fi/public\\_html/paddark/paddark.html#exonuclear](http://tgdtheory.fi/public_html/paddark/paddark.html#exonuclear)) [K23].

### More recent results concerning heat production in Rossi's reactor

According to the article "Indication of anomalous heat energy production in a reactor device containing hydrogen loaded nickel powder" [H25] (<http://arxiv.org/pdf/1305.3913.pdf>) cold fusion has been demonstrated quite convincingly so that "indication" in the title can be take as a humorous understatement.

The studied system is the E-Cat HT of Rossi containing Ni power plus unknown catalyst under hydrogen pressure. The durations of test runs were about 100 hours. Heat cameras were

used to measure the temperature at the upper surface of the cylinder. The lower bound for the heat power estimated theoretically from the temperature distribution using estimates for radiation power, very small conduction power through the contacts with environment, and from estimate convection power through the surrounding air. In one of the runs the input power was 360 W and output power 2034 W giving  $COP \simeq 5.6$ . The run took 96 hours and the weight of Ni cylinder was .236 kg. On basis of this the heat energy per weight is higher than .68 MJ/kg which is higher than for any conventional energy source. This is a lower bound since only the heat energy produced during the test run is included.

To my opinion, it seems safe to conclude that low energy nuclear reactions can be regarded as an established fact and the commercialization is indeed in full swing. It is a pity that at the same time academic theoretical physics after the results from LHC has reached dead end basically due to the sticking to the reductionistic dogma, which does not allow any new physics above elementary particle length scale - and if we believe string theorists- above Planck length scale.

### 7.5.3 Sono-luminescence, classical $Z^0$ force, and hydrodynamic hierarchy of p-adic length scales

Sono-luminescence [D17] , [D17] is a peculiar phenomenon, which might provide an application for the hydrodynamical hierarchy. The radiation pressure of a resonant sound field in a liquid can trap a small gas bubble at a velocity node. At a sufficiently high sound intensity the pulsations of the bubble are large enough to prevent its contents from dissolving in the surrounding liquid. For an air bubble in water, a still further increase in intensity causes the phenomenon of sono-luminescence above certain threshold for the sound intensity. What happens is that the minimum and maximum radii of the bubble decrease at the threshold and picosecond flash of broad band light extending well into ultraviolet is emitted. Rather remarkably, the emitted frequencies are emitted simultaneously during very short time shorter than 50 picoseconds, which suggests that the mechanism involves formation of coherent states of photons. The transition is very sensitive to external parameters such as temperature and sound field amplitude.

A plausible explanation for the sono-luminescence is in terms of the heating caused by shock waves launched from the boundary of the adiabatically contracting bubble [D17] , [D17] . The temperature jump across a strong shock is proportional to the square of Mach number and increases with decreasing bubble radius. After the reflection from the minimum radius  $R_s(min)$  the outgoing shock moves into the gas previously heated by the incoming shock and the increase of the temperature after focusing is approximately given by  $T/T_0 = M^4$ , where M is Mach number at focusing and  $T_0 \sim 300 K$  is the temperature of the ambient liquid. The observed spectrum of sono-luminescence is explained as a brehmstrahlung radiation emitted by plasma at minimum temperature  $T \sim 10^5 K$ . There is a fascinating possibility that sono-luminescence relates directly to the classical  $Z^0$  force.

Even standard model reproduces nicely the time development of the bubble and sono-luminescence spectrum and explains sensitivity to the external parameters [D17] , [D17] . The problem is to understand how the length scales are generated and explain the jump-wise transition to sono-luminescence and the decrease of the bubble radius at sono-luminescence: ordinary hydrodynamics predicts continuous increase of the bubble radius. The length scales are the ambient radius  $R_0$  (radius of the bubble, when gas is in pressure of 1 atm) and the minimum radius  $R_s(min)$  of the shock wave determining the temperature reached in shock wave heating. Zero radius is certainly not reached since shock front is susceptible to instabilities.

#### p-Adic length scale hypothesis and the length scales of sono-luminescence

Since p-adic length scale hypothesis introduces a hierarchy of hydrodynamics with each hydrodynamics characterized by a p-adic cutoff length scale there are good hopes of achieving a better understanding of these length scales in TGD. The change in bubble size in turn could be understood as a change in the 'primary' condensation level of the bubble.

1. The bubble of air is characterized by its primary condensation level  $k$ . The minimum size of the bubble at level  $k$  must be larger than the electron Compton scale  $L_e(k) = \sqrt{5}L(k)$ . This suggests that the transition to photo-luminescence corresponds to the change in the primary

condensation level of the air bubble. In the absence of photo-luminescence the level can be assumed to be  $k = 163$  with  $L_e(163) \sim .76 \mu m$  in accordance with the fact that the minimum bubble radius is above  $L_e(163)$ . After the transition the primary condensation level of the air bubble one would have  $k = 157$  with  $L_e(157) \sim .07 \mu m$ . In the transition the minimum radius of the bubble decreases below  $L_e(163)$  but should not decrease below  $L_e(157)$ : this hypothesis is consistent with the experimental data [D17] , [D17] .

2. The particles of hydrodynamics at level  $k$  have minimum size  $L(k_{prev})$ . For  $k = 163$  one has  $k_{prev} = 157$  and for  $k = 157$   $k_{prev} = 151$  with  $L_e(151) \sim 11.8 nm$ . It is natural to assume that the minimum size of the particle at level  $k$  gives also the minimum radius for the spherical shock wave since hydrodynamic approximation fails below this length scale. This means that the minimum radius of the shock wave decreases from  $R_s(min, 163) = L_e(157)$  to  $R_s(min, 157) = L_e(151)$  in the transition to sono-luminescence. The resulting minimum radius is  $11 nm$  and much smaller than the radius  $.1 \mu m$  needed to explain the observed radiation if it is emitted by plasma.

A quantitative estimate goes along lines described in [D17] , [D17] .

1. The radius of the spherical shock is given by

$$R_s = At^\alpha , \quad (7.5.1)$$

where  $t$  is the time to the moment of focusing and  $\alpha$  depends on the equation of state (for water one has  $\alpha \sim .7$ ).

2. The collapse rate of the adiabatically compressing bubble obeys

$$\frac{dR}{dt} = c_0 \left( \frac{2}{3\gamma} \frac{\rho_0}{\rho} \left( \frac{R_m}{R_0} \right)^3 \right)^{1/2} , \quad (7.5.2)$$

where  $c_0$  is the sound velocity in gas,  $\gamma$  is the heat capacity ratio and  $\rho_0/\rho$  is the ratio of densities of the ambient gas and the liquid.

3. Assuming that the shock is moving with velocity  $c_0$  of sound in gas, when the radius of the bubble is equal to the ambient radius  $R_0$  one obtains from previous equations for the Mach number  $M$  and for the radius of the shock wave

$$\begin{aligned} M &= \frac{\frac{dR_s}{dt}}{c_0} = (t_0/t)^{\alpha-1} , \\ R_s &= R_0 (t/t_0)^\alpha , \\ t_0 &= \frac{\alpha R_0}{c_0} . \end{aligned} \quad (7.5.3)$$

where  $t_0$  is the time that elapses between the moment, when the bubble radius is  $R_0$  and the instant, when the shock would focus to zero radius in the ideal case. For  $R_0 = L_e(167)$  (order of magnitude is this) and for  $R_s(min) = L_e(151)$  one obtains  $R_0/R_s(min) = 256$  and  $M \simeq 10.8$  at the minimum shock radius.

4. The increase of the temperature immediately after the focusing is approximately given by

$$\frac{T}{T_0} \simeq M^4 = \left( \frac{R_0}{R_s} \right)^{\frac{4(1-\alpha)}{\alpha}} \simeq 1.3 \cdot 10^4 . \quad (7.5.4)$$

For  $T_0 = 300 K$  this gives  $T \simeq 4 \cdot 10^6 K$ : the temperature is far below the temperature needed for fusion.

In principle the further increase of the temperature can lead to further transitions. The next transition would correspond to the transition  $k = 157 \rightarrow k = 151$  with the minimum size of particle changing as  $L_e(k_{prev}) \rightarrow L_e(149)$ . The next transition corresponds to the transition to  $k = 149$  and  $L_e(k_{prev}) \rightarrow L_e(141)$ . The values of the temperatures reached depend on the ratio of the ambient size  $R_0$  of the bubble and the minimum radius of the shock wave. The fact that  $R_0$  is expected to be of the order of  $L_e(k_{next})$  suggests that the temperatures achieved are not sufficiently high for nuclear fusion to take place.

### Could sonoluminescence involve the formation of a phase near vacuum extremals?

In TGD inspired model of cell membrane [K57] a key role is played by almost vacuum extremals for which the induced Kähler field is very small. Vacuum extremals are accompanied by a strong classical  $Z^0$  field proportional to classical electromagnetic field and given by  $Z^0 = -2\gamma/p$ ,  $p = \sin^2(\theta_W)$ . One could also imagine that em field is vanishing in which case  $Z^0$  field is proportional to Kähler field and also strong because of  $Z^0 = 6J/p$ ,  $p = \sin^2(\theta_W)$  proportionality. In this case also classical color fields are present. It is however not clear whether these fields can be realized as preferred extremals of Kähler action.

The classical  $Z^0$  field should have a source and the vacuum polarization in the sense that flux tubes are generated with many fermion state and its conjugate at its opposite ends would generate it. The Compton scale of weak bosons must correspond to  $L_e(157)$  so that either dark variants of ordinary weak bosons or their light variants would be in question. Both would be effectively massless below  $L_e(157)$ . The simplest situation corresponds to many-neutrino state for vacuum extremals but also many quark states are possible when em field for the flux tube vanishes.

The length scales involved correspond to Gaussian Mersennes  $M_{G,k} = (1+i)^k - 1$  and together with  $k = 151$  and  $k = 167$  define biologically important length scales [K57]. The p-adically scaled up variants and dark variants of QCD and weak physics have been conjectured to play key role in biology between length scales 10 nm (cell membrane thickness) and 2.5  $\mu\text{m}$  (the size scale of nucleus). This motivates the question whether a nearly vacuum extremal phase (as far as induced gauge fields are considered) accompanies the transition changing the p-adic length scale associated with the bubble from  $k = 163$  to  $k = 157$ . The acceleration in the strong  $Z^0$  field associated with the flux tubes could generate the visible light as brehmstrahlung radiation, perhaps also  $Z^0$  and  $W$  brehmstrahlung could be generated and would decay to photons and charged particles and generate a plasma in this manner. If the weak scale is given by  $k_W = 157$ , the mass scale of weak bosons is  $2^{-31} \simeq 10^{-9}/2$  times smaller than that of ordinary weak bosons (about 50 eV which corresponds to a temperature of  $5 \times 10^5$  K). A further transition to  $k = 151$  would correspond to gauge boson mass scale 400 eV and temperature or order  $4 \times 10^6$  K.

### Could phase transitions increasing Planck constant and p-adic prime accompany sonoluminescence

In sonoluminescence external sound source induces oscillation of the radius of a bubble of water containing noble gas atoms. The unexpected observation is generation of radiation even at gamma ray energies and it is proposed that nuclear fusion might take place.

A possible new element in the model is  $h_{eff}$  increasing phase transition of the space-time sheet containing the water vapour and other atoms to dark phase during the expansion phase and reduction back to the ordinary value during implosion period now forced by the sound wave. If implosion actually takes place spontaneously then the energy of sound wave could be liberated as luminescence. If also dark hydrogen atoms are generated, dark protons could be able to circumvent the Coulomb wall so that low energy nuclear reactions could occur. On the other hand, if the phase transition reducing the Planck constant and increasing p-adic length scale takes place for the water space-time sheet in such a manner that the two scale changes compensate each other (this requires  $h_{eff} = 2^k h$  and  $p \rightarrow 2^{2k} p$  (this is an excellent approximation), zero point kinetic energy (ZPKE) is liberated and could heat the bubble and induce high energy radiation and perhaps even the proposed ordinary fusion. Cold fusion however seems more elegant alternative. The fact that neutron yield has not been observed in sonoluminescence suggests that ordinary hot fusion is not involved.



I have earlier considered the possibility that classical long ranged  $Z^0$  fields predicted by TGD might be involved and give rise to a new interaction possibly related to sonoluminescence. I have proposed that classical  $Z^0$  fields could play a role in the physics of cell membrane. The speculative proposal is that cell membrane could be in two possible states: the first ("ordinary") state would correspond to far from vacuum extremal for which electric field dominates. Second state would be near to vacuum extremal: in this case classical  $Z^0$  field would dominate and give rise to rather radical modification of the model for cell membrane since  $Z^0$  membrane potential would replace the ordinary one. Neurons serving as sensory receptors might correspond to this phase.

This model remains very speculative as also the possible role of classical  $Z^0$  fields in sonofusion. Note however that the phase transition increasing  $h_{eff}$  implies a dilution to vapour like phase ("electrically expanded water") and means that the state is near vacuum. By quantum classical correspondence classical  $Z^0$  fields might become important. In the case of cell membrane  $Z^0$  Coulomb energy defined by  $Z^0$  potential is much stronger than its electronic counterpart and corresponds to voltage of order few eV and therefore to visible photon energies roughly 50 times higher than the energies assignable to the ordinary membrane potential of about .06 eV. One can wonder whether similar effect could appear also in electrolysis where also strong local electric fields appear.

## 7.6 The TGD variant of the model of Widom and Larsen for cold fusion

Widom and Larsen (for articles see the Widom Larsen LENR Theory Portal [C7] (<http://newenergytimes.com/v2/sr/WL/WLTheory.shtml>)) have proposed a theory of cold fusion (LENR) [C5], which claims to predict correctly the various isotope ratios observed in cold fusion and accompanying nuclear transmutations. The ability to predict correctly the isotope ratios suggests that the model is on the right track. A further finding is that the predicted isotope ratios correspond to those appearing in Nature which suggests that LENR is perhaps more important than hot fusion in solar interior as far as nuclear abundances are considered. TGD leads to the same proposal and Lithium anomaly could be understood as one implication of LENR [L3]. The basic step of the reaction would rely on weak interactions: the proton of hydrogen atom would transform to neutron by capturing the electron and therefore would overcome the Coulomb barrier.

### 7.6.1 Challenges of the model

The model has to meet several challenges.

1. The electron capture reaction  $p + e \rightarrow n + \nu$  is not possible for ordinary atom since the mass difference of neutron is 1.3 MeV and larger than electron mass .5 MeV (electron has too small kinetic energy). The proposal is that strong electric fields at the catalyst surface imply renormalization effects for the plasmon phase at the surface of the catalyst increasing electron mass so that it has width of few MeVs [C44]. Physically this would mean that strong em radiation helps to overcome the kinematical threshold for the reaction. This assumption [C26]: the claim is that the mass renormalization is much smaller than claimed by Widom and Larsen.
2. Second problem is that weak interactions are indeed very weak. The rate is proportional to  $1/m_W^4$ ,  $m_W \sim 100$  GeV whereas for the exchange of photon with energy  $E$  it would be proportional to  $1/E^4$ . For  $E \sim 1$  keV the ratio of the rates would be of the order of  $10^{-48}$ !

This problem could be circumvented if the transition from proton to neutron occurs coherently for large enough surface patch. This would give rate proportional to  $N^2$ , where  $N$  is the number electrons involved. Another mechanism hoped to help to get high enough reaction rate is based on the assumption that the neutron created by the capture process has ultra-low momentum. This is the case if the mass renormalization of electron is such that the energies of the neutrons produced in the reaction are just above the kinematical threshold. Note however that this reduces the electron capture cross section. The argument is that the absorption rate for neutron by target nucleus is by very general arguments proportional to

$1/v_n$ ,  $v_n$  the velocity of neutron. Together these two mechanisms are hoped to give high enough rate for cold fusion.

3. The model must also explain why gamma radiation is not observed and why neutrons are produced much less than expected. Concerning gamma rays one must assume that the heavy electrons of the plasmon phase assigned to the surface of the catalyst absorb the gamma rays and re-emit them as infrared light emitted to environment as heat. Ordinary electrons cannot absorb gamma rays but heavy electrons can [C43], and the claim is that they do transform gamma rays to infrared photons. If the neutrons created in LENR have ultra-low energies their capture cross sections are enormous and the claim is that they do not get out of the system.

The assumption that electron mass is renormalized so that the capture reaction can occur but occurs only very near threshold so that the resulting neutrons are ultraslow has been criticized [C26].

### 7.6.2 TGD variant of the model

TGD allows to consider two basic approaches to the LENR.

1. **Option I** involves only dark nucleons and dark quarks. In this case, one can imagine that the large Compton length of dark proton - at least of order atomic scale - implies that it overlaps target nucleus, which can see the negatively charged  $d$  quark of the proton so that instead of Coulomb wall one has Coulomb well.
2. **Option II** involves both dark weak bosons and possibly also dark nucleons and dark electrons. The TGD inspired model for living matter - in particular, the model for cell membrane involving also  $Z^0$  membrane potential in the case of sensory receptor neurons [K21] - favors the model involving both dark weak bosons, nucleons, and even electrons. Chiral selection for biomolecules is extremely difficult to understand in standard model but could be understood in terms of weak length scale of order atomic length scale at least: below this scale dark weak bosons would be effectively massless and weak interactions would be as strong as em interactions. The model for electrolysis based on plasmoids identified as primitive life forms supports also this option. The presence of dark electrons is suggested by Tesla's cold currents and by the model of cell membrane.

This option is fixed quantitatively by the condition that the Compton length of dark weak bosons is of the order of atomic size scale at least. The ratio of the corresponding p-adic size scales is of order  $10^7$  and therefore one has  $h_{eff} \sim 10^{14}$ . The condition that  $h_{eff}/h = 2^k$  guarantees that the phase transition reducing  $h_{eff}$  to  $h$  and increasing p-adic prime  $p$  by about  $2^k$  and p-adic length scale by  $2^{k/2}$  does not change the size scale of the space-time sheet and liberates cyclotron magnetic energy  $E_n(1 - 2^{-k}) \simeq E_n$ .

Consider next **Option II** by requiring that the Coulomb wall is overcome via the transformation of proton to neutron. This would guarantee correct isotope ratios for nuclear transmutations. There are two options to consider depending on whether a) the W boson is exchanged between proton nucleus (this option is not possible in standard model) or b) between electron and proton (the model of Widom and Larsen relying on the critical massivation of electron).

1. **Option II.1.** Proton transforms to neutron by exchanging W boson with the target nucleus.
  - (a) In this case kinematics poses no obvious constraints on the process. There are two options depending on whether the neutron of the target nucleus or quark in the neutral color bond receives the W boson.
  - (b) If electron and proton are dark with  $h_{eff}/h = n = 2^k$  in the range  $[10^{12}, 10^{14}]$  the situation can change since W boson has its usual mass from the point of view of electron and proton.  $\hbar^4/m_W^4$  factor in differential cross section for 2-to-2 scattering by W exchange is scaled up by  $n^4$  (see the appendix of [A7] so that effectively  $m_W$  would be of order 10 keV for ordinary  $\hbar$ .

(c) One can argue that in the volume defined by proton Compton length  $\lambda_p \simeq 2^{-11}\lambda_e \in [1.2, 12]$  nm one has a superposition of amplitudes for the absorption of dark proton by nucleus. If there are  $N$  nuclei in this volume, the rate is proportional to  $N^2$ . One can expect at most  $N \in [10^3, 10^6]$  target nuclei in this volume. This would give a factor in the range  $10^9 - 10^{12}$ .

2. **Option II.2:** Electron capture by proton is the Widom-Larsen candidate for the reaction in question. As noticed, this process cannot occur unless one assumes that the mass of electron is renormalized to have a value in a range of few MeV. If dark electrons are heavier than ordinary, the process could be mediated by W boson exchange and if the electron and proton have their normal sizes the process occurs with same rate as em processes.

If electron and proton are dark with  $h_{eff}/h = n \in [10^{12}, 10^{14}]$  the situation can change since W boson has its usual mass from the point of view of electron and proton. 2-to-2 cross section is proportional to  $\hbar^4$  and is scaled up by  $n^4$ . On the other hand, the naive expectation is that  $|\Psi(0)|^2 \propto m_e^3/h_{eff}^3 \propto 1/n^{-3}$  for electron is scaled by  $n^{-3}$  so that the rate is increased by a factor of order  $n \in [10^{12}, 10^{14}]$  (electron Compton length is of order cell size scale! instead of Angstrom) from its ordinary value. This is not enough.

On the other hand, one can argue in the volume defined by proton Compton size one has a superposition of amplitudes for the absorption of electron. If there are  $N$  dark electrons in this volume, the rate is proportional to  $N^2$ . One can expect at most  $10^6$  dark electrons in the volume of scale 10 nm so that this could give a factor  $10^{12}$ . This would give amplification factor  $10^{26}$  to the weak rate so that it would be only by two orders of magnitude smaller than the rate for massless weak bosons.

There are also other strange features to be understood.

1. The absence of gamma radiation could be due to the fact that the produced gamma rays are dark. For  $h_{eff}/h \in [10^{12}, 10^{14}]$  the energy frequency of 1 MeV dark gamma ray would correspond to that of photon with energy of  $[1, 1] \mu\text{eV}$  and thus to radio wave photon with wavelength of order 1 m and frequency of order  $3 \times 10^8$  Hz. In Widom-Larsen model the photons would be infrared photons. The decay of the dark gamma ray to a bunch of ordinary radio wave photons should be observed as radio noise. Note that Gariaev has observed transformation of laser light scattered from DNA to radio wave photons with frequencies down to 1 kHz at least.
2. The absence of the neutrons could be understood if they are dark and simply do not interact with visible matter before phase transition to ordinary neutrons. One can imagine an alternative interpretation allowing the interaction and assuming that nuclei are dark in the reaction volume. The large Compton wavelength implies that dark neutrons are absorbed by dark nuclei coherently in a volume of order 1.2-12 nm so that an additional amplification factor  $N^2 \in [10^9, 10^{12}]$  would be obtained. The absorption cross section for neutrons should be proportional to  $\hbar^2$  giving a huge amplification factor in the range  $[10^{24}, 10^{48}]$ . Effectively this corresponds to the assumption of Widom and Larsen stating that neutrons have ultra-low momentum.

The natural question is why  $h_{eff}$  is such that the resulting scale as photon wavelength corresponds to energy in scale 10-100 keV. The explanation could relate to the predicted exotic nuclei obtained by replacing some neutral color bonds connecting nucleons with charged ones and exchange of weak boson would affect this replacement. Could the weak physics associated with  $h_{eff} \in [10^{12}, 10^{14}]$  be associated with dark color bonds? The reported annual variations of the nuclear reaction rates correlating with the distance of Earth from Sun suggest that these variations are induced by solar X rays [C18].

## 7.7 Does ZPE have TGD counterpart?

The attempts to understand Brown's gas and related phenomena involve the notion of zero point energy (ZPE). This notion can be criticized as mathematically unacceptable and also physical

objections against it can be found. In TGD framework dark matter and dark energy are realized in non-conventional manner. Many-sheeted space-time concept (see fig. <http://www.tgdtheory.fi/appfigures/manysheeted.jpg> or fig. 9 in the appendix of this book) implies also the notion of zero point kinetic energy (ZPKE) as zero point kinetic energy of a particle localized inside space-time sheet: p-adic length scale hypothesis allows to quantify this notion. These notions replace the ZPE but do not provide any magic energy source. Even more science fictive option can be imagined: zero energy ontology (ZEO) makes possible effectively the creation of matter from vacuum without breaking conservation laws. In the following I compare ZPE and TGD based approach to make it easier to understand the TGD inspired model for Brown's gas.

### 7.7.1 Moddell and ZPE

Garret Moddell has written an excellent popular article about ZPE ([http://ecee.colorado.edu/~moddel/QEL/Papers/VacEnergyExtrac\\_Jan10.pdf](http://ecee.colorado.edu/~moddel/QEL/Papers/VacEnergyExtrac_Jan10.pdf)). Moddell and Haisch have proposed a model for how one might be able to utilize ZPE. Moddell mentions the proposal at the end of the article.

The article represents some basic physical objections against ZPE. The most serious mathematical objection against ZPE is that in QED vacuum energy density assignable to virtual photons and fermion pairs is strictly infinite or zero: depending on whether one performs so called normal ordering which is mathematically acceptable but not elegant. One can perform a cutoff in frequencies at say Planck frequency to get finite vacuum energy. This however breaks Lorentz symmetry.

In supersymmetric theories ZPE vanishes identically. This conforms with the physical view about vacuum energy as energy due to the closing of the system to a finite volume: Uncertainty Principle implies ZPE for all particles including photon. As the size of the volume becomes infinite, ZPE should vanish. One can imagine also forms of vacuum energy for which the density is finite. In particular, energy density of Higgs field for a state with non-vanishing vacuum expectation value can be non-vanishing and finite. Usually ZPE does not however mean this.

The basic physical objections discussed by Moddell are following. Moddell considers objections against two ideas for extracting ZPE and then represents the proposal by him and Haisch.

1. Standard physics argument is that a system able to extract ZPE would be Maxwell demon and thus break second law of thermodynamics. A very plausible sounding objection to this is that one could use diode which allows current only in second direction. Electrons absorb virtual photons of ZPE and are gradually transferred to another electrode so that their energy is transformed to electrostatic energy. In fact any noise can produce this kind of effect and one can indeed realize this situation (see below). Moddell actually leaves open whether this kind of process should happen or not.

The fact is however that the charging does not happen without some artificial background noise: the straightforward conclusion would be that ZPE vanishes so that the argument pro ZPE turns against ZPE.

The so called ratchet principle ([http://en.wikipedia.org/wiki/Ratchet\\_\(device\)](http://en.wikipedia.org/wiki/Ratchet_(device))) is a generalization of the diode idea to any system in which change of dynamical variable can be only in one direction due to the presence of constraints. The ratchet can be also mechanical and is used in machinery. That background noise can be transformed to mechanical work is demonstrated experimentally (<http://www.nld.ds.mpg.de/~bioentropy/material/Toyabe2010.pdf>). The claim of the article that this demonstrates also Maxwell demon at work is to my opinion wrong. This experiment however suggest that if ZPE is there it should in principle make itself visible in diode like systems. It does not.

Stochastic resonance is a phenomenon analogous to what happens in ratchet: here random noise amplifies oscillations of bistable oscillator (two equilibrium positions) if the oscillation frequency is suitable related to the frequency like parameter characterizing the noise. For instance, brains use stochastic resonance to amplify weak signals.

2. One can ask whether it could be possible to transfer energy from the frequency distribution of the vacuum energy to a frequency range where it can be used. In recent electronics only radio frequencies can be used and the photon energies proportional to frequency are very

small. Could it be possible to transform low frequency photons to higher frequency ones, say visible photons. This does not work according to an argument developed by Einstein: induce and spontaneous emissions guarantee that the energy transfers occur in both directions and compensate each other.

In fact, TGD predicts the desired mechanism although the motivations was not this. For large value of Planck constant  $h_{eff} = nh$  the energy of dark photon is given by  $E = h_{eff}f$  and therefore low frequency photons, say EEG photons with extremely low energy much below physiological thermal threshold, can become very energetic. This makes quantum coherence possible in long length scales. TGD based model of living matter relies on this mechanism. Tesla's cold currents could consist of dark electrons.

3. The third trial is based on Casimir cavities. For Casimir cavities the notion of ZPE is physically well-motivated and experimentally verified as a force between the conductor sheets of the cavity. This does not however provide infinite energy source. The reason is that the force is conservative. If one manages to get continually work from the system one must do the compensating work to return the system to the original state.
4. Moddel and Haisch propose a modification based on ZPE. One brings into the cavity atoms and assumes that they have lower ground state energy than outside the cavity. The atoms go to the lower ground state and radiate energy which can be used. After than the atoms are brought out and they return to the ordinary ground state by extracting ZPE.

The basic objection is that the ground state energy of atoms is expected to be higher inside the cavity than outside. The zero point energy due to the closure of atomic to the cavity increases its energy and also the zero point energy of virtual photons is inside cavity is expected to be higher than outside by Uncertainty Principle. Therefore one would not gain energy.

If the energy is indeed lower inside the cavity (for instance, one might argue that this could be due to the phenomenon replacing that principal quantum number  $n$  of hydrogen atom by  $1/n$  as claimed by Randell Mills). Of course, if ZPE vanishes it requires work to get the atoms out of the cavity.

The proposal of Moddell and Haisch have been tested in the laboratory led by Moddell. Olga Dimitrieva has made a thesis about the heat production in LENR (cold fusion) believed to take place in cold fusion (<http://ecee.colorado.edu/~moddel/QEL/Papers/DmitriyevaThesis12.pdf>) [C13]. The thesis contains an Appendix which is about the testing of the proposal of Moddell and Haisch and not directly related to the content of the thesis.

The conclusion of the abstract of the Appendix is that conventional models for the thermodynamics of Casimir cavity do not explain the findings completely. Photon emissions in IR range are observed. From the text one however learns that the ZPE predictions for gas in Casimir cavity are not consistent with what was observed.

In more detail the argument goes as follows.

1. Stochastic electrodynamics (not standard QED) is the starting point. ZPE photons are absorbed and emitted and equilibrium situation prevails. Electrons emit Larmor radiation changing the spin direction of electron "down" in absence of absorption of ZPE. In equilibrium the energies should shift: effect would be Lamb+Casimir that is Lamb in finite cavity. The hope is that energies shift downwards. This is not proven. Above just the opposite is argued to happen.
2. The walls of Casimir cavity should be conducting. This is guaranteed by gold coated filter through which gas flows to the cavity and out of it. Several gases have been tested and also non-coated filters for which Casimir effect should be absent.
3. IR emission was observed. Contrary to expectations He gas produces highest emission and it does not matter whether coating is present or not so that Lamb+Casimir does not explain the finding.

The thesis proper demonstrates that anomalous heat production takes place in H-D cold fusion. The hypothesis that certain chemical reaction could explain the heat production is studied. This model is not excluded but it is noticed that it does not work in more general cold fusion: say when D is replaced with Ni.

### 7.7.2 To what ZPE corresponds in TGD Universe?

The comparison of ZPE based explanations of claimed free energy phenomena demonstrates correspondence between ZPE and certain TGD based notions. Dark matter as large  $h_{eff}$  phases magnetic bodies whose magnetic energy corresponds to dark energy seems to take the role of ZPE to some extent. A third important piece is p-adic length scale hypothesis and the proposal that zero point kinetic energies (ZPKE as opposed to ZPE) for particles topologically condensed on space-time sheets define a hierarchy of metabolic energy quanta.

Both hydrinos, hydrolysis and strange properties of Brown's gas, cold fusion, Tesla's cold currents, the phenomena related to rotating magnetic systems (Yildiz magnetic motor) have models involving these concepts. Also the characteristic features of living matter are modelled using same notions. Even remote mental interactions would rely on same universal mechanism involved magnetic body and dark matter in TGD sense.

This generality is what encourages to take seriously this approach and the details of particular model are bound to vary as more data emerges.

A further element is zero energy ontology (ZEO), which makes possible to literally create worlds from vacuum meaning apparent breaking of conservation laws.

1. The reason is that quantum states correspond to physical events in ordinary ontology: pairs of positive and negative energy state corresponding to the initial and final state of physical event. The usual positive energy ontology can be seen as an erratic extrapolation assuming much more than observations actually allow to assume. Conservation laws and symmetries are not broken in the re-creation process associated with the quantum jump leading to state function reduction.
2. Conservation laws hold always only in scale defined by the causal diamond (CD) defined as intersection of two light-cones in opposite time directions). Positive and negative energy parts of the states reside at opposite boundaries of given CD and CDs form a fractal scale hierarchy. This is actually anything terribly new. The notion of renormalization group has been part of quantum field theories from the beginning. What is new that one gives up the notion of positive energy state as a fundamental notion.
3. The connection with positive energy ontology is that the observer which is small as compared to the CD in question sees either the positive or negative energy part of the state and therefore uses positive energy ontology (sign of energy is of course convention). If CD is much smaller than observer, observer sees the zero energy states as quantum fluctuation.

There are actually indications for necessity of ZEO already in existing physics.

1. In the model of superconductivity coherent states are essential. Coherent state is quantum superposition with all possible boson numbers. In superconductivity bosons are fermion pairs. Therefore the super-selection rule that the fermion number of quantum state is well-defined is broken and in principle fermion number non-conservation becomes possible. In ZEO this problem disappears.
2. In cosmology energy is not conserved in cosmic scales but is conserved in laboratory scales (Poincare invariance of particle physics). The resolution of the problem is that the relevant ZEOs have totally different size scales in cosmology and particle physics.
3. The basic prediction of quantum measurement theory based on ZEO is that the direction of thermodynamical arrow of time alternates in the sequence of state function reductions taking place to the two boundaries of given CD. The reason is that the resulting zero energy states have definite and opposite arrow of geometric time reflecting itself also at the space-time geometry and topology by quantum classical correspondence. Fantappie was an Italian

theoretical physicist who observed already at thirties that in living matter the arrow of thermodynamical time seems to be variable and introduced the notion of syntropy which could be identified as entropy with non-standard time direction. Also phase conjugate laser rays obey second law in wrong direction of time.

4. In free energy phenomena cooling of environment is often reported suggesting non-standard arrow of geometric time and transformation of heat to work temporarily not allowed by the standard form of second law, which generalizes in ZEO.

I wrote about the relationship of ZEO and ZPE a blog article (<http://matpitka.blogspot.fi/2013/05/about-god-theory-of-bernard-haisch.html>). The basic point is that the idea about creation essential for the "God theory" of Haisch - leads to difficulties with conservation laws. ZPE is the proposed solution. To my opinion it is not since XPE breaks the Lorentz invariance of the theory and forces to make ad hoc assumption about the interaction of matter with ZPE.

Creation (or re-creation) as quantum jump in positive energy ontology would break the laws of physics. In ZEO this is not the case. Quantum jumps replaces quantum superposition of worlds obeying laws of physics with a new one. Conservation laws are not broken.

I have not applied the idea about re-creation to explain any anomalies: just to avoid irritating colleagues too much.

### ZPKE as analog of ZPE?

ZPE has also ZPKE (zero point kinetic energy) of particle topological condensed at given space-time sheet as TGD analog.

1. Space-time sheets have finite size. This implies zero point kinetic energy (ZPKE) for all particles. Even for photons in the same way as in wave guide. It is easy to estimate the value of ZPKE if one can assume that kinetic energy dominates and one has non-relativistic situation. For a particle of mass  $m$  inside a space-time sheet of size  $L$  one has apart from a numerical factor

$$E_0 \propto \frac{\hbar^2 \pi^2}{2mL^2} .$$

$E_0$  does not depend on  $h_{eff}$  replacing  $h$  in general case since  $L$  scales like  $h_{eff}$ .

2. p-Adic length scale hypothesis inspired by p-adic mass calculations replaced  $L$  by a hierarchy of p-adic length scales  $L_p$  with p-adic primes satisfying  $p \simeq 2^k$  and  $p < 2^k$ . Especially favored are Mersenne primes  $p = M_n = 2^n - 1$  and their complex counterparts. p-Adic length scales can be expressed in excellent approximation in the form  $L_p \equiv L(k) = 2^{(k-151)/2} \times L(151)$ ,  $L(151) = 10$  nm, which happens to be the thickness of cell membrane. The numerical factor in  $E_0$  does not depend on  $p$  if p-adic fractality is assumed. This makes possible to make rather precise predictions.
3. ZPKE is clearly analogous to Casimir effect. Now the cavity containing photons is replaced with space-time sheet and virtual photons inside cavity are replaced with real particles. In fact, the analog of Casimir effect is expected since the total energy of particle system depends on the size of the space-time sheet.

It turns out that for proton the ZEPK for condensation at  $k = 137$  space-time sheet equals (note that  $k = 137$  is inverse of fine structure constant) is about .5 eV and corresponds to the nominal value of metabolic energy quantum. The ZPKE is same for electron condensed at  $k = 149$  space-time sheet since the masses of electron and proton relate approximately by a factor  $2^{-11}$ .  $L(149)$  corresponds to the thickness of the lipid layer of cell membrane. The proposal is that metabolic energy quanta (at least those above thermal energy) form a fractal hierarchy.

One can imagine two mechanisms by which zero point kinetic energies can serve as metabolic energy quanta.

1. Option I (the original proposal). Particles at given space-time sheet can drop to a larger space-time sheet leading to a liberation of ZPKE. The dropping of  $k = 137$  proton or  $k = 149$  electron to a larger space-time sheet would lead to a liberation of a metabolic energy quantum. On the other hand, if particles are driven to smaller space-time sheet they gain zero point kinetic energy.
2. Option II (the new one). Phase transitions changing the p-adic prime of the space-time sheets containing the particles are possible. Dropping is therefore not necessary! These phase transitions can increase the value of p-adic prime and reduce ZPKE leading to a liberation of ZPKE as usable energy. This system indeed serves as the analog of population reversed laser since all particles experience the reduction of ZPKE simultaneously, and can liberate large amounts of energy in a quantum coherent phase transition like manner.

### 7.7.3 Hierarchy of Planck constants

#### Background

1. The observations about effects of radiation at ELF frequencies on vertebrate brain was the first motivation for the hierarchy of Planck constant identified in terms of phases of matter behaving like dark matter locally. What was found were quantal effects assignable to cyclotron transitions in magnetic field of magnitude  $B = .2$  Gauss which is  $2/5$  of the Earth's magnetic field and identified as endogenous magnetic field. Cyclotron energies in field of this strength are how extremely and quantum effects should be totally masked by the thermal noise. The attempts to understand why EEG manages to correlate so strongly with the state of brain and what is the function of EEG meet the same problem. If  $h_{eff} = nh$  is assumed the situation changes and  $E = h_{eff}f$  allows to have photon energies above thermal threshold even for ELF frequencies if  $h_{eff}$  is large enough. It is known that dark matter accounts most of the matter and also that dark energy is also present. The natural hypothesis is that dark matter corresponds to large  $h_{eff} = nh$  phases at magnetic flux quanta and dark energy to the magnetic energy of the flux quanta carrying magnetic monopole fluxes.
2. The observation that the stoichiometry of water is  $H_{1.5}O$  in atto second time scales (in ZEO this statement makes sense) led to the conclusion that every fourth proton is dark in the sense that it is not visible in neutron diffraction and electron scattering. The presence of dark protons and even dark nuclei formed as string like structures formed by them and possibly forming analogs of atoms involving also dark electrons, could relate to the thermodynamical anomalies of water.

#### A possible model for dark particles

The proposed model involving only phase transitions for the space-time sheet at which particles of water are topologically condensed, is certainly the simplest one but not the only possible option for darkness. For instance, one can consider dark variants of proton and electron and in the model of living matter they play a key role.

1. A model for dark electrons ([http://www.tgdtheory.fi/public\\_html/articles/teslaling.pdf](http://www.tgdtheory.fi/public_html/articles/teslaling.pdf), [K90]) assignable to neuronal cell membrane combines increase of effective Planck constant and increase of p-adic prime characterizing the particle and the idea about fractionized particle as n-particle state of 1/n-fractionized particles with quantum numbers scaled down by 1/n-factor. These states are obtained by a phase transition increasing  $h_{eff} = nh$ ,  $n = 2^k$ . This induces fractionization of the particle to n-sheeted structure. p-adic length assignable to the  $n$  space-time sheets of the dark particle is scaled to p-adic prime  $\simeq 2^k p$  so that mass at given sheet is scaled down by 1/n factor for each fractional particle at each sheet. Since there are  $n$  sheets mass remains unchanged. Same applies to all quantum numbers.
2. One can consider several variants of dark proton. The space-time sheet associated with proton with size scale of proton Compton length can become dark but quarks remain as such. One would have  $n = 2^k$  1/n-fractional protons at  $n$  sheets of the covering with total quantum numbers same as for ordinary proton and p-adic length scale scaled up by a factor



$2^k$ . Also the quarks inside proton can become dark and their size therefore can increase. This could give rise to the proposed dark protons possibly explaining the strange stoichiometry of water at atto-second time scale and also various anomalies of water.

### Applications in biology

Magnetic body whose flux quanta carry dark particles as cyclotron Bose-Einstein condensates is basic element of TGD inspired view about living matter [K90]. The "motor actions" of the magnetic body have key role in the model.

1. Inside cell phase transitions increasing or reducing the volume of cytoplasm are general ("electric expansions" and implosions in Brown's gas). The proposal is that these phase transitions are induced by  $h_{eff}$  changing phase transitions for magnetic flux tubes inducing the corresponding change of their length. The same mechanism could also bring together distant molecules connected by flux tubes in very selective manner: this would make possible for molecules to find each other in the molecular crowd of cytoplasm.
2. Reconnection of flux tubes in turn makes it possible to build flux tube connections with other molecules by controlling the thickness of the flux tube and therefore the value of the local magnetic field, which must be same for two reconnecting flux tubes. This implies also that cyclotron frequencies are same. This makes possible a mechanism of directed attention and sense of presence at molecular level since molecule can generate negentropic entanglement with another one by this mechanism. In fact, the basic task of ATP would be to build reconnections between molecules and build at the same time negentropic entanglement. Metabolic energy as such would not be fundamental: conscious experience made possible by the negentropic entanglement (see fig. <http://www.tgdtheory.fi/appfigures/cat.jpg> or fig. 21 in the appendix of this book) would be more fundamental. Later a more precise view about what happens when metabolic energy is used will be considered.
3. An observation which came as a complete surprise was that in a simple model for dark proton the states can be classified in such a manner that they correspond to DNA, RNA, tRNA and amino-acids. Also vertebrate genetic code had natural realization as mapping between DNA type states and amino-acid type states [K32]. This generated the idea that genetic code and counterparts of fundamental biomolecules are realized already at the level of dark nuclear physics. This would of course revolutionize the views about biology. What we seen in biochemistry would be only shadows on the wall of Plato's cave. Dark biomolecules would also make possible R&D at the level of biology since dark biology would make possible kind of virtual biology: experimentation is done first using dark biomolecules and if something working is found, transcription to ordinary biomolecules is carried out. Water memory, homeopathy, basic mechanism of immune system, and cell membran containing copy of DNA as dark DNA realized as dark proton sequences are ensuing proposals [K32]. Water would be living: genetic code for water clusters would be realized as sequences of dark protons.

#### 7.7.4 How p-adic length scale hypothesis and hierarchy of Planck constants are related?

p-Adic length scale hypothesis and the hypothesis about hierarchy of metabolic energy quanta are corner stones of TGD inspired view about living matter. Also the hierarchy of Planck constants plays a crucial role and one expects a connection between the two notions. I have not been able to integrate these ideas together in a really convincing manner.

The attempt to achieve this integration in the general model for free energy anomalies however led to a small modification of the existing view about how zero point kinetic energy could be liberated as metabolic energy quanta could allow to fuse this notion with that of hierarchy of Planck constants: the scaling of  $h$  to  $nh_{eff}$  for  $n = 2^k$  for space-time sheet containing particle followed by the reverse scaling and p-adic phase transition increasing  $p$  by factor  $n = 2^k$  (in excellent approximation would reduce ZPKE and therefore liberate zero point kinetic energy as usable energy.

## 7.8 TGD inspired model of Brown's gas and related phenomena

Many claimed free energy phenomena relate to the electrolysis of water (hydrolysis) induced by various manners (usually by a current running between electrodes) with two water molecules producing  $2H_2$  and  $O_2$ . If water splitting involves only standard chemistry, it would require energy. Experimenters however report that the reaction liberates energy. Electrolysis without power feed is the ultimate test for the concept and closed loop electrolysis has been reported by two groups of Steven Eaton and Jeff Sokol and Oliver and Valentin mentioned in the lectures of Moray B. King [H29] (<http://www.sciencedirect.com/science/article/pii/S1875389211006079>). The notion of hydrino atom as scaled down hydrogen atom with fractionization of the principal quantum number  $n$  (Mills suggests  $n \rightarrow 1/n$  [D23] but also  $n \rightarrow n/m$ ,  $m = 2, 3, \dots$  can be considered) is related also to hydrolysis.

Also cold fusion for which evidence is growing involves electrolysis. Coulomb wall makes cold fusion impossible in standard physics framework so that academic community as a rule refuses to take the cold fusion claims seriously. There might be a connection between the energy production in hydrolysis and cold fusion: for instance, Kanarev, who has studied hydrolysis and cold fusion expert Mizuno have indeed reported the occurrence of cold fusion in hydrolysis.

The general strategy concerning the understanding of free energy relies on the assumption that a very large class of anomalous phenomena rely on same basic mechanism. This includes life as a phenomenon, water memory and homeopathy, free energy phenomena involving overunity phenomena related to the dissociation of water, lightning and ball lightning, anomalous effects associated with rotating magnetic systems, phenomena related to UFOs (light balls), even remote mental interactions. One must have unified explanation for all these phenomena based on a real theory. This excludes zero point energy (ZPE) type models based on ad hoc solution of a mathematical problem with no hints about how ZPE would interact with matter.

Plasmoid as primitive life form would be the underlying connecting thread between these phenomena so that all the listed phenomena would involve life and prebiotic (or possibly postbiotic!) life. This gives very strong constraints on the model. Plasmoid should consist of the analogs of linear biomolecules, it should metabolize and communicate, in TGD Universe it should have magnetic body, and even genetic code might be realized. In particular, the simplified analog of biological metabolism would be at work. In living matter photosynthesis relies on the splitting of water whereas cell respiration relies on the reversal of this process producing carbon dioxide and water. Something very similar should happen in free energy systems involving electrolysis, and the fact that water splitting occurs also in several free energy phenomena suggests that these processes are analogous to photosynthesis and store energy to "molecules" analogous to various linear biomolecules, in particular sugars. Even the counterpart of ADP-ATP process might be realized.

In the sequel I will consider a TGD inspired model based on the notion of dark matter identified as hierarchy of quantum coherent phases with non-standard value of Planck constant given by  $h_{eff} = n \times h$ . The basic proposal - motivated originally by quite different experimental anomalies - is that water contains a dark component consisting of dark proton strings representing dark nuclei in nuclear string model [K26, K23, L3]. The plasmoids would consist of ring like structures formed by exotic water molecules for which second  $H$  is dark: these dark protons would combine by color bonds to form ring like dark nucleus. One cannot exclude the possibility that also other than water molecules contain dark protons: the signature would be the presence of apparently unallowed covalent bonds due to the fact the dark proton is not visible. In the following I will discuss the basic principles involved. For instance, the -H and O-H groups of carbohydrates might contain dark protons. Free energy phenomena would in this framework basically correspond to a generation of prebiotic lifeforms predicted already in the model of water memory and homeopathy [K32].

### 7.8.1 Brown's gas

Beloved child has many names and so does also Brown's gas. Stoichiometric mixture of  $H_2$  and  $O_2$ , HHO gas (atomic hydrogen and oxygen), hydroxy, oxy-hydrogen, electrically expanded water, charged water clusters. These names give some idea about assumptions about what might be

involved.

Brown's gas is what is created in the hydrolysis identified now as splitting of water molecules (somewhat confusingly, in biology it corresponds to splitting of molecules liberating water). It might be involved also with phenomena like steam electricity, waterfall ionization, thunder could separation, and sonoluminescence: all these phenomena involving charge separation in macroscopic scales and this phenomenon is not well understood. The lecture notes of Moray B. King (<http://www.sciencedirect.com/science/article/pii/S1875389211006079>) provide a good overall view about Brown's gas and one can also find references.

1. Brown's gas does not behave exactly like mono-atomic or diatomic hydrogen and looks like gaseous water with excess electrons. The Brown's gas flame resulting in hydrolysis is cool: the temperature is around 130 C. The flame is however able to melt metals which have roughly 10 times higher melting temperature. The flame sublimates tungsten with vaporization temperature of 5555 C, and cuts cleanly through wood, metal and ceramics. The flame does not boil water although its temperature is higher than boiling point of water.
2. The flame induces electric shock suggesting that charge or their separation in long enough scales is present. This observation brings in mind the reports of Tesla about the physiological effects caused by what he called dark currents.
3. Usual gas tends to expand but Brown's gas implodes. What this phase transition like phenomenon means is not understood but it suggests that Brown's gas is not usual hydrogen but that also second component is present. Simple but ingenious experiments manage to separate this component and it turns out that it is than ordinary hydrogen gas.
4. Brown's gas is reported to affect radio-activity. For instance, neutralization of radioactive wastes is reported. Low energy nuclear reactions (cold fusion) and nuclear transmutations are also associated with Brown's gas. This suggests a direct connection with low energy nuclear reactions (LENR, cold fusion).
5. Brown's gas involves unknown component. This can be demonstrated in several manners.
  - (a) Fill balloon with the Brown's gas and waiting it to fall to ground as hydrogen leaks out. What remains still exhibits balloon torch.
  - (b) Fill paper bag with the gas. Seal bag shut. Wait 12 hours for hydrogen to vent away. Open the bag. A gains heavier than air remains and can be ignited.
  - (c) Glass pouring test. Gas is heavier than air and can be poured from glass to another one. Ignite the gas at the bottom of the glass.
6. George Wiseman has observed that Brown's gas burns downward in an imploding ring. This has probably motivated the term "Electrically Expanded Water".

Charged water clusters forming vapour is one proposed identification of the Brown's gas. The motivation comes from the fact that laboratory analysis finds only little hydrogen in the flame. What remains is proposed to consist of gaseous charged water clusters. Charged water cluster have been noticed to be analogous to plasma cluster and microscopic ball lightning. The charged water clusters would behave like Rydberg matter ([http://en.wikipedia.org/wiki/Rydberg\\_matter](http://en.wikipedia.org/wiki/Rydberg_matter)) involving core ions and de-localized electrons at circular orbits with large value of the principal quantum number  $n$  known as Rydberg orbits.

There is analogy of charged water clusters with two poorly understood phenomena: steam electricity [H46] (<http://www.esdjournal.com/techpapr/prevens/previndx.htm>) and waterfall ionization. Also thunder cloud charge separation and sonoluminescence might involve the formation of charged water clusters.

According to Moray B. King [H29] charged water clusters are formed in the cavitation of water. Cavitation can be induced either mechanically or by electric pulsing using strong electric field having interpretation as a modulation of carrier frequency by the pulse frequency. King [H4] (<http://www.free-energy-info.co.uk/MorayKing.pdf>) has discussed the possibility that charged water clusters are plasmoids, whose basic units are linear closed ring like structures consisting of sequences ...-O-H-O-..... From the view point of chemistry the problem is that the bonds

do not have interpretation as covalent bonds. The stoichiometry would be also HO rather than H<sub>2</sub>O, which leads to ask where the second H resides.

In TGD framework it would be highly desirable to assign to plasmoids dipole magnetic field and corresponding magnetic body but the proposed structure does not suggest any obvious identification of the needed ring current. The hint comes from the observation that 1/4:th of protons of water in atto-second time scale are dark in the sense that they are not visible in electron scattering and neutron diffraction. Maybe the rings are actually sequences of exotic water molecules for which the second proton is dark in some sense.

An alternative possibility is that - in accordance with the original model for  $H_{1.5}O$  stoichiometry of water [K32] - these sequences are just dark proton sequences at the magnetic flux tubes associated with the exotic blob of water carrying negative charge. The protons would be outside the blob at magnetic flux tubes so that charge separation would result. This picture is forced by the findings of the group led by Gerald Pollack [L10].

To summarize: Brown's gas seems to involve two components. The other one is ordinary hydrogen and second one something heavier than air and responsible for the strange properties of Brown's gas. The basic properties of Brown's gas to be explained are electric expansion, implosion, over unity energy production, low temperature contra ability to melt metal, and the presence of a component heavier than air.

### 7.8.2 Pollack's findings about fourth phase of water

What is described above was the view about Brown's gas before I received a link to a Youtube lecture by Gerald Pollack about fourth gel like phase of water (see <https://www.youtube.com/watch?v=i-T7tCMUDXU>) [L10]. Listening this lecture provided considerable support for this picture and led to a much more detailed and also simplified view.

The discovery of negatively charged exclusion zone formed in water bounded by gel phase was the motivation for Pollack to propose the notion of gel like fourth phase of water. Below I discuss this notion from TGD point of view.

The proposal will be that the fourth phase corresponds to negatively charged regions - exclusion zones - with size up to 100-200 microns generated when energy is fed into the water - say as radiation, in particular solar radiation. The stoichiometry of the exclusion zone is  $H_{1.5}O$  and can be understood if every fourth proton is dark proton residing at the flux tubes of the magnetic body assignable to the exclusion zone and outside it. This leads to a model for prebiotic cell as exclusion zone. Dark protons are proposed to form dark nuclei whose states can be grouped to groups corresponding to DNA, RNA, amino-acids, and tRNA and for which vertebrate genetic code is realized in a natural manner [K32, L3]. The voltage associated with the system defines the analog of membrane potential, and serves as a source of metabolic energy as in the case of ordinary metabolism. The energy is liberated in a reverse phase transition in which dark protons transform to ordinary ones. Dark proton strings serve as analogs of basic biopolymers, and one can imagine analog of bio-catalysis with enzymes replaced with their dark analogs. The recent discovery that metabolic cycles emerge spontaneously in absence of cell support this view.

#### The findings

One can find a biographical sketch [I11] (<http://faculty.washington.edu/ghp/cv/>) giving a list of publications containing items related to the notions of exclusion zone and fourth phase of water discussed in the talk. I list below some basic experimental findings about fourth gel like phase of water made in the laboratory led by Gerald Pollack [L10].

1. In water bounded by a gel a layer of thickness up to 100-200 microns is formed. All impurities in this layer are taken outside the layer. This motivates the term "exclusion zone". The layer consists of layers of molecular thickness and in these layers the stoichiometry is  $H_{1.5}O$ . The layer is negatively charged. The outside region carries compensating positive charge. This kind of blobs are formed in living matter. Also in the splitting of water producing Brown's gas negatively charged regions are reported to emerge [H29, H4].
2. The process requires energy and irradiation by visible light or thermal radiation generates the layer. Even the radiation on skin can induce the phase transition. For instance, the

blood flow in narrow surface veins requires metabolic energy and irradiation forces the blood to flow.

3. The layer can serve as a battery: Pollack talks about a form of free energy deriving basically from solar radiation. The particles in the layer are taken to the outside region, and this makes possible disinfection and separation of salt from sea water. One can even understand how clouds are formed and mysteries related to the surface tension of water as being due the presence of the layer formed by  $H_{1.5}O$ .
4. In the splitting of water producing Brown's gas [H29, H4] having a natural identification as Pollack's fourth phase of water the needed energy can come from several alternative sources: cavitation, electric field, etc...

### Dark nuclei and Pollack's findings

While listening the lecture of Pollack I realized that a model for dark water in term of dark proton sequences is enough to explain the properties of the exotic water according to experiments done in the laboratory of Pollack. There is no need to assume sequences of half-dark water molecules containing one dark proton each.

1. The dark proton sequences with dark proton having size of order atomic nucleus would reside at the flux tubes of dark magnetic field which is dipole like field in the first approximation and defines the magnetic body of the negatively charged water blob. This explains the charge separation if the flux tubes have length considerably longer than the size scale of the blob which is given by size of small cell. In the model inspired by Moray B. King's lectures charge separation is poorly understood.
2. An interesting question is whether the magnetic body is created by the electronic currents or whether it consists of flux tubes carrying monopole flux: in the latter case no currents would be needed. This is obviously purely TGD based possibility and due to the topology of  $CP_2$ .
3. This means that in the model inspired by the lectures of Moray B. King discussed above, one just replaces the sequences of partially dark water molecules with sequences of dark protons at the magnetic body of the  $H_{1.5}O$  blob. The model for the proto-variants of photosynthesis and metabolism remain as such. Also now genetic code would be realized.

These primitive forms of photosynthesis and metabolism form could be key parts of their higher level chemical variants. Photosynthesis by irradiation would induce a phase transition generating dark magnetic flux tubes (or transforming ordinary flux tubes to dark ones) and the dark proton sequences at them. Metabolism would mean burning of the resulting blobs of dark water to ordinary water leading to the loss of charge separation. This process would be analogous to the catabolism of organic polymers liberating energy. Also organic polymers in living matter carry their metabolic energy as dark proton sequences: the layer could also prevent their hydration. That these molecules are typically negatively charged would conform with the idea that dark protons at magnetic flux tubes carry the metabolic energy.

The liberation of energy would involve increase of the p-adic prime characterizing the flux tubes and reduction of Planck constant so that the thickness of the flux tubes remains the same but the intensity of the magnetic field is reduced. The cyclotron energy of dark protons is liberated in coherent fashion and in good approximation the frequencies of the radiation corresponds to multiplies of cyclotron frequency: this prediction is consistent with that in the original model for the findings of Blackman and others [J11].

The phase transition generating dark magnetic flux tubes containing dark proton sequences would be the fundamental step transforming inanimate matter to living matter and the fundamental purpose of metabolism would be to make this possible.

### Minimal metabolic energy consumption and the value of membrane potential

This picture raises a question relating to the possible problems with physiological temperature.

1. The Josephson radiation generated by cell membrane has photon energies coming as multiples of  $ZeV$ , where  $V$  is membrane potential about .06 V and  $Z = 2$  is the charge of electron Cooper pair. This gives  $E = .12$  eV.
2. There is a danger that thermal radiation masks Josephson radiation. The energy for photons at the maximum of the energy density of blackbody radiation as function of frequency is given as the maximum of function  $x^3/(e^x - 1)$ ,  $x = E/T$  given by  $e^{-x} + x/3 - 1 = 0$ . The maximum is given approximately by  $x = 3$  and thus  $E_{max} \simeq 3T$  (in units  $c = 1, k_B = 1$ ). At physiological temperature  $T = 310$  K (37 C) this gives .1 eV, which is slightly below Josephson energy: living matter seems to have minimized the value of Josephson energy - presumably to minimize metabolic costs. Note however that for the thermal energy density as function of *wavelength* the maximum is at  $E \simeq 5T$  corresponding to 1.55 eV which is larger than Josephson energy. The situation is clearly critical.
3. One can ask whether also a local reduction of temperature around cell membrane in the fourth phase of water is needed.
  - (a) "Electric expansion" of water giving rise to charge separation and presumably creating fourth phase of water is reported to occur [H29, H4].
  - (b) Could the electric expansion/phase transition to dark phase be adiabatic involving therefore no heat transfer between the expanding water and environment? If so, it would transform some thermal energy of expanding water to work and reduce its temperature. The formula for the adiabatic expansion of ideal gas with  $f$  degrees of freedom for particle ( $f = 3$  if there are no other than translational degrees of freedom) is  $(T/T_0) = (V/V_0)^{-\gamma}$ ,  $\gamma = (f + 2)/f$ . This gives some idea about how large reduction of temperature might be involved. If p-adic scaling for water volume by a power of two takes place, the reduction of temperature can be quite large and it does not look realistic.
  - (c) The electric expansion of water need not however involve the increase of Planck constant for water volume. Only the Planck constant for flux tubes must increase and would allow the formation of dark proton sequences and the generation of cyclotron Bose-Einstein condensates or their dark analog in which fermions (electrons in particular) effectively behave as bosons (the anti-symmetrization of wave function would occur in dark degrees of freedom corresponding to multi-sheeted covering formed in the process).

#### Fourth phase of water and pre-biotic life in TGD Universe

If the fourth phase of water defines pre-biotic life form then the phase transition generating fourth phase of water and its reversal are expected to be fundamental elements of the ordinary metabolism, which would have developed from the pre-biotic metabolism. The following argument conforms with this expectation.

1. Cell interiors, in particular the interior of the inner mitochondrial membrane are negatively charged as the regions formed in Pollack's experiments. Furthermore, the citric acid cycle, ([http://www.en.wikipedia.org/wiki/Citric\\_acid\\_cycle](http://www.en.wikipedia.org/wiki/Citric_acid_cycle)), which forms the basic element of both photosynthesis (<http://www.en.wikipedia.org/wiki/Photo-synthesis>) and cellular respiration ([http://www.en.wikipedia.org/wiki/Cellular\\_respiration](http://www.en.wikipedia.org/wiki/Cellular_respiration)), involves electron transport chain ([http://www.en.wikipedia.org/wiki/Electron\\_transport\\_chain](http://www.en.wikipedia.org/wiki/Electron_transport_chain)) in which electron loses gradually its energy via production of NADP and proton at given step. Protons are pumped to the other side of the membrane and generates proton gradient serving as metabolic energy storage just like battery. The interpretation for the electron transport chain in terms of Pollack's experiment would be in terms of generation of dark protons at the other side of the membrane.
2. When ATP is generated from ADP three protons per ATP flow back along the channel formed by the ATP synthase molecule ([http://www.en.wikipedia.org/wiki/ATP\\_synthase](http://www.en.wikipedia.org/wiki/ATP_synthase)) (perhaps Josephson junction) and rotate the shaft of a "motor" acting as a catalyst generating three ATP molecules per turn by phosphorylating ADP. The TGD based interpretation is

that dark protons are transformed back to ordinary ones and possible negentropic entanglement is lost.

3. ATP is generated also in glycolysis (<http://www.en.wikipedia.org/wiki/Glycolysis>), which is ten-step process occurring in cytosol so that membrane like structure need not be involved. Glycolysis involves also generation of two NADH molecules and protons. An open question (to me) is whether the protons are transferred through an endoplasmic reticulum or from a region of ordered water (fourth phase of water) to its exterior so that it would contribute to potential gradient and could go to magnetic flux tubes as dark proton. This would be natural since glycolysis is realized for nearly all organisms and electron transport chain is preceded by glycolysis and uses as input the output of glycolysis (two pyruvate molecules (<http://www.en.wikipedia.org/wiki/Pyruvate>)).
4. Biopolymers - including DNA and ATP - are typically negatively charged. They could thus be surrounded by fourth phase of water and neutralizing protons would reside at the magnetic bodies. This kind of picture would conform with the idea that the fourth phase (as also magnetic body) is fractal like. In phosphorylation the metabolic energy stored to a potential difference is transferred to shorter length scales (from cell membrane scale to molecular scale).

In glycolysis (<http://www.en.wikipedia.org/wiki/Glycolysis>) the net reaction  $C_6H_{12}O_6 + 6O_2 \rightarrow 6CO_2(g) + 6H_2O(l) + \text{heat}$  takes place. The Gibbs free energy change is  $\Delta G = -2880$  kJ per mole of  $C_6H_{12}O_6$  and is negative so that the process takes place spontaneously. Single glucose molecule is theoretized to produce  $N = 38$  ATP molecules in optimal situation but there are various energy losses involved and the actual value is estimated to be 29-30. From  $Joule = 6.84 \times 10^{18}$  eV and  $mol = 6.02 \times 10^{23}$  and for  $N = 38$  one would obtain the energy yield .86 eV per single ATP. The nominal value that I have used .5 eV. This is roughly 5 to 8 times higher than  $E = ZeV, Z = 2$ , which varies in the range .1-.16 eV so that the metabolic energy gain cannot be solely due to the electrostatic energy which would actually give only a small contribution.

In the thermodynamical approach to metabolism the additional contribution would be due to the difference of the chemical potential  $\mu$  for cell exterior and interior, which is added to the membrane potential as effective potential energy. The discrepancy is however rather large and this forces the question the feasibility of the model. This forces to reconsider the model of osmosis in the light of Pollack's findings.

### Pollack's findings in relation to osmosis and model for cell membrane and EEG

Osmosis (<http://en.wikipedia.org/wiki/Osmotic>) has remained to me poorly understood phenomenon. Osmosis means that solvent molecules move through a semipermeable membrane to another side of the membrane if the concentration of solute is higher at that side. Solute can be water or more general liquid, supercritical liquid, and even gas.

Osmosis is not diffusion: it can occur also towards a higher concentration of water. Water molecules are not attracted by solute molecules. A force is required and the Wikipedia explanation is that solute molecules approaching pores from outside experience repulsion and gain momentum which is transferred to the water molecules.

The findings of Pollack inspire the question whether the formation of exclusion zone could relate to osmosis and be understood in terms of the fourth phase of water using genuine quantal description.

In the thermodynamical model for ionic concentrations one adds to the membrane resting potential a contribution from the difference of chemical potentials  $\mu_i$  at the two sides of the membrane. Chemical potentials for the ions parametrize the properties of the cell membrane reducing basically to the properties of the channels and pumps (free diffusion and membrane potential do not entirely determine the outcome).

If the transfer of ions - now protons - through cell membrane is quantal process and through Josephson junctions defined by transmembrane proteins, then the thermodynamical model can at best be a phenomenological parameterization of the situation. One should find the quantum counterpart of thermodynamical description, and here the identification of quantum TGD as square root of thermodynamics in Zero Energy Ontology (ZEO) suggests itself. In this approach thermodynamical distributions are replaced by probability amplitudes at single particle level such that their moduli squared give Boltzmann weights.

### 1. Simplest Josephson junction model for cell membrane

The first guess is that quantum description is achieved by a generalization of the Josephson junction model allowing different values of Planck constant at magnetic flux tubes carrying dark matter.

1. Josephson junctions correspond microscopically to transmembrane proteins defining channels and pumps. In rougher description entire cell membrane is described as Josephson junction.
2. The magnetic field strength at flux tube can differ at the opposite side of the membrane and even the values of  $h_{eff}$  could in principle be different. The earlier modelling attempts suggest that  $h_{eff}/h = n = 2^k A$ , where  $A$  is the atomic weight of ion, is a starting assumption deserving testing. This would mean that each ion resides at its own flux tubes.

The phase transitions changing the value of  $h_{eff}$  could induce ionic flows through cell membrane, say that occurring during nerve pulse since the energy difference defining the ratio of square roots of Boltzmann weights at the two sides of the membrane would change. Also the change of the local value of the magnetic field could do the same.

Consider first the simplest model taking into account only membrane potential.

1. The simplest model for Josephson junction defined by the transmembrane protein is as a two state system  $(\Psi_1, \Psi_2)$  obeying Schrödinger equation.

$$i\hbar_1 \frac{\partial \Psi_1}{\partial t} = ZeV\Psi_1 + k_1\Psi_2 \quad ,$$

$$i\hbar_2 \frac{\partial \Psi_2}{\partial t} = k_2\Psi_2 \quad .$$

One can use the decomposition  $\Psi_i = R_i \exp(i\Phi(t))$  to express the equations in a more concrete form. The basic condition is that the total probability defined as sum of moduli squared equals to one:  $R_1^2 + R_2^2 = 1$ . This is guaranteed if the hermiticity condition  $k_1/\hbar_1 = \overline{k_2}\hbar_2$  holds true. Equations reduce to those for an ordinary Josephson junction except that the frequency for the oscillating Josephson current is scaled down by  $1/h_{eff}$ .

2. One can solve for  $R_2$  assuming  $\Phi_1 = eVt/h_{eff}$ . This gives

$$R_2(t) = \sin(\Phi_0) + \frac{k_1}{\hbar_1} \sin\left(\frac{eVt}{\hbar_1}\right) \quad .$$

$R_2$  oscillates around  $\sin(\Phi_0)$  and the concentration difference is coded by  $\Phi_0$  taking the role of chemical potential as a phenomenological parameter.

3. The counterparts of Boltzmann weights would be apart from a phase factor square roots of ordinary Boltzmann weights defined by the exponent of Coulomb energy:

$$R = \sin(\phi_0) = \exp\left(\frac{ZeV(t)}{2T}\right) \quad .$$

Temperature would appear as a parameter in single particle wave function and the interpretation would be that thermodynamical distribution is replaced by its square root in quantum theory. In ZEO density matrix is replaced by its hermitian square root multiplied by density matrix.

### 2. The counterpart of chemical potential in TGD description

This model is not as such physically realistic since the counterpart of chemical potential is lacking. The most straightforward generalization of the thermodynamical model is obtained by the addition of an ion dependent chemical potential term to the membrane potential:  $ZeV \rightarrow ZeV + \mu_I$ . This would however require a concrete physical interpretation.



1. The most obvious possibility is that also the chemical potential actually correspond to an interaction energy - most naturally the cyclotron energy  $E_c = \hbar_{eff} Z e B_{end} / m$  of ion - in this case proton - at the magnetic flux tube. Cyclotron energy is proportional to  $\hbar_{eff}$  and can be rather large as assumed in the model for the effects of ELF em fields on brain.
2. This model would predict the dependence of the effective chemical potential on the mass and charge of ion for a fixed value of on  $\hbar_{eff}$  and  $B_{end}$ . The scales of ionic chemical potential and ion concentrations would also depend on value of  $\hbar_{eff}$ .
3. The model would provide a different interpretation for the energy scale of bio-photons, which is in visible range rather than infrared as suggested by the value of membrane potential.

The earlier proposal [K29] was that cell membrane can be in near vacuum extremal configuration in which classical  $Z^0$  field contributes to the membrane potential and gives a large contribution for ions. The problematic aspect of the model was the necessity to assume Weinberg angle in this phase to have much smaller value than usually. Furthermore, for proton the  $Z^0$  contribution is negligible in good approximation so that this model does not explain the high value of the metabolic energy currency.

4. The simplest model the communications to magnetic body rely on Josephson radiation whose fundamental frequency  $f_J$  is at resonance identical with the cyclotron frequency  $f_c(MB)$  at particular part of the flux tube of the magnetic body:  $f_c(MB) = f_J$ .  $f_c(MB)$  corresponds to EEG frequency in the case of brain and biophotons are produced from dark EEG photons as ordinary photons in phase transition reducing  $\hbar_{eff} = n \times h$  to  $h$ .

In the modified model the sum  $f_c + f_{J,n}$  ( $f_{J,n} = E_J / n \times h$ ) of  $\hbar_{eff}$ -independent cyclotron frequency and Josephson frequency proportional to  $1/\hbar_{eff}$  equals to cyclotron frequency  $f_c(MB)$  at "personal" magnetic body varying slowly along the flux tube:  $f_c + f_{J,n} = f_c(MB)$ . If also the variation of  $f_J$  assignable to the action potential is included, the total variation of membrane potential gives rise to a frequency band with width roughly

$$\frac{\Delta f}{f} \simeq \frac{2f_{J,n}}{f_c + f_{J,n}} = \frac{2f_{J,1}}{nf_c + f_{J,1}} .$$

If dark photons correspond to biophotons the energy is of cyclotron photon is in visible and UV range one has  $nf_c = E_{bio}$  and

$$\frac{\Delta f}{f} \simeq \frac{2ZeV}{E_{bio} + ZeV} .$$

The prediction is scale invariant and same for all ions and also electron unless  $E_{bio}$  depends on ion. For  $eV = .05$  eV,  $Z = 1$ , and  $E_{bio} = 2$  eV ( $f \simeq 5 \times 10^{14}$  Hz) one has  $\Delta f/f \sim .1$  giving 10 per cent width for EEG bands assumed in the simpler model.

If this vision is on the correct track, the fundamental description of osmosis would be in terms of a phase transition to the fourth phase of water involving generation of dark matter transferred to the magnetic flux tubes. For instance, the swelling of cell by an in-flow of water in presence of higher concentration inside cell could be interpreted as a phase transition extending exclusion zone as a process accompanied by a phase transition increasing the value of  $\hbar_{eff}$  so that the lengths of the flux tube portions inside the cell increase and the size of the exclusion zone increases. In general case the phase transitions changing  $\hbar_{eff}$  and  $B_{end}$  by power of two factor are possible. This description should bring magnetic body as part of bio-chemistry and allow understanding of both equilibriumion distributions, generation of nerve pulse, and basic metabolic processes leading to the generation of ATP.

### Why would charge separation generate large $\hbar_{eff}$ ?

The basic question is whether and how the separation of electron and proton charges generates large  $\hbar_{eff}$ ? A possible mechanism emerged from a model [K97] explaining anomalously large gravimagnetic effect claimed by Tajmar et al [E18, ?] to explain the well-established anomaly

related to the mass of Cooper pairs in rotating super-conduction. The mass is too large by fraction of order  $10^{-4}$  and the proposal is that gravimagnetism changes slightly the effective Thomson magnetic field associated with the rotating super-conductor leading to wrong value of Cooper pairs mass when only ordinary Thomson field is assumed to be present. The needed gravimagnetic field is however gigantic: 28 orders larger than that predicted by GRT. Gravimagnetic field is proportional  $h_{eff}^2$  in TGD and if one uses  $h_{gr}$  for electron-Earth system one obtains correct order of magnitude.

Nottale's finding that planetary orbits seem to correspond to Bohr orbits in gravitational potential with gigantic value of gravitational Planck constant is the basic input leading to the model of gravimagnetic anomaly.

1. By Equivalence Principle  $h_{gr}$  has the general form  $h_{gr} = GMm/v_0$ , where  $M$  and  $m$  are the interacting masses and  $v_0$  is a parameter with dimensions of velocity. For three inner planets one has  $v_0/c \simeq 2^{-11}$ .
2. The notion of  $h_{gr}$  generalizes to that for other interactions. For instance, in electromagnetic case the formation of strong em fields implying charge separation leads to systems in which  $h_{em} = Z_1 Z_2 e^2 / v_0$  is large. Pollack's exclusion zone and its complement define this kind of systems and is identified as prebiotic life form.
3. Since the natural expansion parameter of perturbative expansion is the  $g^2/4\pi\hbar$ , one can say that transition to dark matter phase make the situation perturbative. Mother Nature is theoretician friendly.

$h_{em}$  might be large in the exclusion zones (EZ) appearing in the water bounded by gel and their variants could play central role in living matter.

1. EZ carries very large negative charge with positive charge outside the exclusion zone.
2. TGD interpretation is in terms of  $H_{1.5}O$  phase of water formed when every 4:th proton is transferred to magnetic body as dark particle with large value of  $h_{eff}$ . The proposal is that primitive life form is in question.
3. The pair formed by EZ and its complement could have large value of  $h_{eff} = h_{em} = Z^2 e^2 / v_0$ .
4. The velocity parameter  $v_0$  should correspond to some natural rotation velocity. What comes in mind is that complement refers to Earth and  $v_0$  is the rotation velocity at the surface of Earth. The prediction for  $h_{eff}$  would be of order  $h_{em}/h = 4\pi\alpha Z^2 \times .645 \times 10^6 \simeq 5.9 \times 10^4 Z^2$ .
5. Cell membrane involves also large charge separation due to very strong electric field over the cell membrane. Also now dark phases with large  $h_{em}$  or  $h_{gr}$  could be formed.

I have proposed that metabolic machinery generates large  $h_{eff}$  phase somehow.  $h_{eff} = h_{em}$  hypothesis allows to develop this hypothesis in more detail.

1. I have speculated earlier [K35] that the rotating shaft of a molecular motor associated with ATP synthase plays a key role in generating dark matter phase. What comes in mind is that charge separation takes place associating exclusion zone with the shaft and the rotational velocity  $v_0$  of the shaft appears in the formula for  $h_{em}$ . Of course, some numerical constant not far from unity could be present. The electric field over the mitochondrial membrane generates charge separation. One can imagine several identifications for the product of charges. The charge  $Z$  associated with the complement would be naturally associated with single dark flux tube containing dark nucleon consisting of dark protons. For instance, the charge associated with the exclusion zone could be the charge of the electronic Cooper pair giving  $h_{em} = 2e \times Z/v_0$ .
2. The value of  $v_0/c$  is expected to be of order  $10^{-14}$  from the angular rotation rate of ADP synthase about few hundred revolutions per second. The order of magnitude for  $h_{em}$  could be same as for  $h_{gr}$  associated with Earth-particle system.

$h_{eff}(ATP\text{synthase}) = h_{gr}(2e, Earth)$  would make possible reconnection of electromagnetic flux tubes with gravimagnetic flux tubes [K55].

### Which came first: metabolism or cell membrane?

One of the basic questions of biology is whether metabolism preceded basic biopolymers or vice versa. RNA world scenario assumes that RNA and perhaps also genetic code was first.

1. The above view suggests that both approaches are correct to some degree in TGD Universe. Both metabolism and genetic code realized in terms of dark proton sequences would have emerged simultaneously and bio-chemistry self-organized around them. Dark proton sequences defining analogs of amino-acid sequences could have defined analogs of protein catalysts and played a key role in the evolution of the metabolic pathways from the primitive pathways involving only the phase transition between ordinary water and fourth phase of water.
2. There is very interesting article [I12] reporting that complex metabolic pathways are generated spontaneously in laboratory environments mimicking hot thermal vents. Glycolysis and pentose phosphate pathway were detected. The proposal is that these pathways are catalyzed by metals rather than protein catalysts.
3. In standard biology these findings would mean that these metabolic pathways emerged before basic biopolymers and that genetic code is not needed to code for the metabolic pathways during this period. In TGD framework dark genetic code [K32, L3] would be there, and could code for the dark pathways. Dark proton strings in one-one correspondence with the amino-acid sequences could be responsible for catalysts appearing in the pathways. Only later these catalysts would have transformed to their chemical counterparts and might be accompanied by their dark templates. One cannot even exclude the possibility that the chemical realization of the DNA-aminoacid correspondence involves its dark analog in an essential manner.

### 7.8.3 A model for Brown's gas

The simplest TGD inspired model for the Brown's gas combines three phase transitions taking place for the space-time sheet at which particle has suffered topological condensation. The first is the increase of Planck constant by factor  $2^n$  and second its reverse (electric expansion and implosion). The third phase transition is reduction of Planck constant combined with a compensating increase of the p-adic length scale so (liberation of ZPKE or its magnetic analog) as usable energy.

Both expansion and implosion happen. Expansion could correspond to  $h_{eff}$  increasing phase transition for water or some protons of water giving rise to strings made of dark protons in TGD inspired model of dark matter. Implosion could correspond to the inverse of this phase transition. These transitions would preserve ZPKE or its analog. The liberation of ZPKE or its analog could take place in a phase transition reducing  $h_{eff} = 2^k h$  back to  $h$  but increasing the p-adic scale for the space-time sheet by factor  $2^{k/2}$  (in excellent approximation) so that the size of the space-time sheet would not be affected but vacuum energy would be reduced.

### Three possible models for liberation of metabolic energy

One can imagine three different models for the liberation of metabolic energy.

1. The simplest TGD based model is as a phase transition increasing the value of p-adic prime  $p$  assignable to the space-time sheet at which particle is topologically condensed:
  - (a) Particle drops to a larger space-time sheet with larger p-adic prime  $p_1$  with  $p_1/p \simeq 2^k$ . The problem is that different particles need not drop simultaneously so that coherent liberation of energy is difficult to achieve.
  - (b) The space-time sheet itself suffers a phase transition increasing its p-adic length scale. The energies are scaled down by factor  $2^{-k}$  and the difference is liberated as usable energy. Coherent liberation of energy is achieved automatically. If the particle inside the space-time sheet is free in good approximation a model as particle in box applies and if the expansion of the space-time sheet takes place adiabatically the quantum numbers characterizing the state of the particle do not change in the transition. As

a consequence, the energy  $E_{\{n_i\}} = k \sum_i n_i^2 \hbar^2 / 2mL_p^2$  is reduced as  $L_p \propto \sqrt{p}$  increases to  $L_{p_1}$ , where  $p_1/p \simeq 2^k$  holds true. The difference of vacuum energies is liberated as usable energy in coherent manner: this is of special significance in living systems.

2. The space-time sheet could also carry magnetic energy and particles are expected to be in cyclotron states and perhaps form a cyclotron Bose-Einstein condensate. In this case the phase transition reduces the value of  $B$  but preserves the magnetic flux so that  $B \rightarrow B/2^k$ ,  $p_1/p \simeq 2^k$ , takes place. This scales down the energies of cyclotron states by the same scaling factor  $2^{-k}$  as in the case of free particle. The liberated energy is in good approximation just the cyclotron energy for large enough values of  $k$ . Coherence is achieved automatically.
3. The earlier model for the liberation of cyclotron energy was based on the assumption that the value of  $B$  is not changed but that the value of magnetic quantum number  $n$  changed. If  $n$  is reduced one achieves liberation of energy. Coherence of the transition might produce problems now. Both models can explain the observations of Blackman and others concerning the effects of ELF radiation on vertebrate brain since the spectrum of photons energies inducing effects correspond to cyclotron energies for the latter option and in excellent approximation to it for the previous model. The mechanism is however quite different.

This phase transition for the larger space-time sheet can take place in two steps.

1. First a phase transition increasing  $\hbar_{eff}$  of the background space-time sheet by  $n = 2^k$  occurs. This leaves ZPKE invariant but scales up the size of the space-time sheet by  $2^{k/2}$ . The interpretation would be as "electric expansion" of Brown's gas. No energy transfer takes place since both kinetic and magnetic energies are invariant under the scaling of  $\hbar$ . Note however than in the original situation the magnetic field can be very strong so that zooming up from microscopic scales can happen.
2. After this a phase transition reducing Planck constant back to  $\hbar$  but increasing p-adic length scale by  $2^k$  occurs. The size scale of the background space-time sheet is not affected but the zero point kinetic energy is reduced by factor  $2^{-k}$  and liberated as usable energy. This phase transition would take place for the dark component of Brown's gas in the melting of the metal and other similar phenomena. Also the liberation of metabolic energy in living matter could correspond to this phase transition.

This model for electric expansion, implosion, and energy liberation assumes nothing about the particles involved since dark particle means ordinary particle topologically condensed on dark space-time sheet and having wave function de-localized in the n-sheeted structure. For instance, water can be dark in this sense. One could indeed consider the possibility that the vapour phase identified as charged water cluster is just water containing positive ions  $H_+^3$  or protons and electrons and that phase transition to large  $\hbar$  phase expands the space-time sheet at which water is topologically condensed at evaporates the water. Ordinary liquid to gas transition could proceed in the same manner and involve liberation of ZPKE at the second step of the process. In the general case the binding energy involved with the formation of the denser phase could compensate for the energy gain in the increase of the p-adic prime so that the melting would require energy feed.

### Model for the building bricks of plasmoids

I have already earlier discussed a model for dark proton sequences as primitive life forms. The observation discussed by Moray B. King inspired a more detailed formulation of the model of plasmoids identified as primitive life forms in TGD framework.

1. The key observation was that the model for dark nuclei [L3, K32], in particular dark proton, predicts counterparts of DNA, RNA, tRNA, and amino-acids and also vertebrate genetic code follows naturally. This together with nuclear string model led to the vision that life appears already at the level of dark variants of nuclei. The observed anomalous  $H_{1.5}O$  stoichiometry of water in atto-second scale supports the view that dark protons appear in ordinary water.

2. This model was first introduced to explain water memory and homeopathy. The basic idea was that the process creating homeopathic remedy induces the analog of molecular evolution for the dark proton sequences, which in turn provide representations for the molecules appearing in environment. These representations would be fundamental also for the functioning of immune system of living matter. The dark life could provide R&D laboratory for living matter allowing to test say various gene candidates and transcribe them to ordinary biological DNAs if they are successful in the virtual model world. Evolution would not be random but directed just as evolution of technologies.
3. The latest step in the process [K92] was the proposal that cell membranes involve dark proton sequences providing a representation of dark DNA and connected by magnetic flux tubes to the units of DNA in genome. These two DNA representations would be identical. Quite generally, dark and ordinary biomolecules might be connected by magnetic flux tubes.

This picture does not yet provide model for the metabolism of the building bricks of plasmoids. Something very much analogous to the splitting of sugars to carbon di-oxide and water is however expected. Since carbon is not present now, this leaves only the option that the linear dark structures are nothing but exotic form of water for which the proton of one hydrogen atom of each water molecule is dark. These dark protons would combine by strong interactions to a nuclear string and O-H groups would be attached to them. The cyclic analog of DNA, RNA, or amino-acid realizing genetic code would be the outcome. The stoichiometry  $H_{1.5}O$  observed in atto-second time scale would be achieved in average sense if the portions of exotic and dark water are same. The prediction is that dark water is heavier than ordinary water: the molecular weight would correspond to average length of the dark water cycle. This is consistent with the observations about Brown's gas.

Plasmoid should also possess a magnetic body. This requires a currents rotating along the cyclic structures. The obvious identification of the current is as dark supra currents assignable to dark protons so that the building bricks of plasmoid would be analogous to super-conducting rings.

### Model for the metabolism of plasmoids

The proposed dark analogs of basic biomolecules would be created through the analog of photosynthesis involving the splitting of water to  $H + OH$  followed by  $H \rightarrow H_{dark}$  and by recombination to a sequence of dark water molecules. The process would be analogous to translation of mRNA to amino-acids and could proceed by an analogous mechanism. The process would be spontaneous since the energy of cyclotron states would not change in  $h \rightarrow h_{eff} = 2^k \times h$ .

Metabolic energy would be liberated in the decay of the exotic water back to water with  $h_{eff} = h$  and p-adic prime scaled by about  $2^k$ . This process is completely analogous to the splitting of various linear biomolecules in metabolism in order to obtain metabolic energy. This process would explain the ability of cool Brown's gas to melt metal for instance. When fossil fuels are used, the outcome is carbon di-oxide and water. Now only water is obtained so that this form of free energy might not contribute to the warming of environment.

The process differs from ZPE in that it does not provide any endless source of energy. Since water is in practice an unlimited natural resource, this should not be a problem. A closed cycle at the level of visible matter is obtained only if the reverse phase transition transforming the water with  $h_{eff} = h$  and p-adic prime  $p_1 \simeq 2^{k/2}p$  to that with  $h_{eff} = 2^k \times h$  and p-adic prime  $p$  takes place spontaneously.

The irradiation with carrier frequency  $f_h$  and modulation frequency  $f_l$  such that one has  $f_l/f_h = 2^k$  is one possibility which I have proposed. Dark solar radiation at magnetic flux tubes with magnetic field  $B_{end} = .2$  Gauss (guess from the experiments of Blackman [J15]; also many other values can be considered) could provide automatically the needed pulsed radiation inducing the phase transition. The most optimistic option is that this transition occurs even in the case of closed system in which water circulates.

Before attempting to identify reasonable candidates for  $f_l$  and  $f_h$  it is useful to consider estimates for  $h_{eff}/h = 2^k$ . Note that this assumption might be too strong: the vision about evolution as emergence of number theoretical complexity suggests that so called Fermat integers defining polygons, which are constructible using ruler and compass, define favored values

of  $h_{eff}/h = n$  [K26]. These integers are expressible as products of different Fermat primes  $F_n = 2^{2^k} + 1$  and power of 2. The known Fermat primes correspond to  $k = 0, 1, 2, 3, 4$  and are 3, 5, 17, 257, 65537. Only the two lowest ones differ significantly from power of two. This raises the question whether also the scale hierarchies  $\sqrt{3}L(k)$ ,  $\sqrt{5}L(k)$ , and  $\sqrt{15}L(k)$  are important besides p-adic length scale hierarchy  $L(k) = 2^{k/2}R_{CP_2}$ . They could be associated with the algebraic extensions of p-adic numbers involving  $\sqrt{3}$  and  $\sqrt{5}$ .

1. The condition that cold nuclear fusion is possible via the TGD based mechanism requires dark variant of weak interactions corresponds to scaled up p-adic length scale of order atomic size. The condition that weak bosons are effectively massless in atomic length scale gives one estimate for  $h_{eff}/h$ . The condition that weak scale characterized by  $M_{89}$  is increased to that characterized by  $M_{127}$  gives  $h_{eff}/h = 2^{48} \simeq 2.8 \times 10^{14}$ .
2. Second estimate for  $h_{eff}/h$  follows from the condition that cyclotron energy for given charged particle is of the order of metabolic energy quantum. For proton  $B_{end} = .2$  Gauss gives  $f_c = 300$  Hz. The energy is about .5 eV for  $h_{eff}/h = 1.37 \times 10^{14}$  rather near to  $h_{eff}/h = 2^{47}$  which is by a factor of 1/2 smaller than the previous estimate. It is however clear that the estimates are internally consistent: skeptic would see this as a pure accident and some-one taking anthropic principle seriously as an outcome of evolution in very general sense. Note that for electron the metabolic energy quantum would be about 938 eV suggesting that keV energy scale assignable to the dark weak interactions has its own metabolic energy quantum. For ion of mass number  $A$  and ionization  $z$  the value producing the same value of metabolic quantum is  $A/z \times 1.37 \times 10^{14}$ . An alternative assumption is a hierarchy of metabolic quanta coming as  $z/A$  multiples of the fundamental metabolic energy quantum for a fixed value of  $h_{eff}/h$ . The condition that the metabolic energy quantum is above thermal energy of photon at physiological temperature for which peak wavelength for blackbody radiation corresponds to energy of .13 eV. This gives  $A/z \leq .5/.13 = 3.84$ . The estimate is too stringent since  $Ca^{++}$  with  $A/z = 20$  should allow metabolic energy quantum above the thermal energy. This suggests that  $h_{eff}/h$  characterizes given ion and that its multiples coming as power of two are allowed.
3. For  $h_{eff}/h = n = 2^{k_{dark}}$  with  $k_{dark} \in \{47, 48\}$  dark electron would have p-adic length scale  $L(k)$ ,  $k = 127 + d_{dark} \in \{174, 175\}$ . This corresponds to a Compton length  $l_c \in \{28, 40\} \mu\text{m}$ . That this corresponds to the size scale of cell gives additional support for the vision. Note also that for electron the size scale of CD identified as secondary p-adic time scale associated with  $M_{127} = 2^{127} - 1$  corresponds to .1 seconds, which defines a fundamental biorhythm. Proton Compton length would be scaled to the range [15, 21] nm (10 nm defines the thickness of the cell membrane) and light current quarks with energy of 5-20 MeV to the size scale of cell nucleus.

A reasonable guess is that the candidates for  $f_h$  and  $f_i$  should satisfy the condition  $f_h/f_i = 2^k$ ,  $k = 47$  or  $k = 48$ .  $f_h$  can be deduced from the estimate for  $h_{eff}$ .

1. Schumann frequency 7.8 Hz is the first candidate for the modulating frequency. This would give UV frequency  $f_h \simeq 1.1 \times 10^{15}$  Hz corresponding to energy of 9.7 eV for  $k = 47$ , which corresponds to the energy scale for covalent bonds. The energy scale of hydrogen atom is 13.6 eV.
2. For the cyclotron frequency of DNA (which depends only weakly on the length of the DNA sequence due to the constant charge density per unit length) of about 1 Hz (the frequency of heart beat) one would obtain  $f_h = 1.4 \times 10^{14}$  Hz for  $k = 47$ , which corresponds to energy of 1.4 eV and is just below the visible range starting around 1.65 eV. The scaling of this energy by  $\sqrt{3}/2$ ,  $\sqrt{5}/4$ , and  $\sqrt{15}/4$  By multiplying the For  $k = 48$  the energy would be to 3.3 eV, which is quite near to the UV end 3.36 eV of visible portion of spectrum. Again one can ask whether just accidents are in question.

Allowing the generalization of the p-adic length scale hypothesis one obtains 7 photon energies in the visible range corresponding to the scalings of 1.4 eV by  $[\sqrt{3}/2, \sqrt{5}/4, \sqrt{5}/2, \sqrt{15}/4, \sqrt{3}, 2, \sqrt{15}/8, \sqrt{5}]$  giving  $E/eV = [1.71, 1.57, 2.21, 1.91, 2.42, 2.71, 2.80, 3.13]$ . Note that 2 eV corresponds to red

light and metabolic energy quantum of .50 eV to  $k = 51$ . An interesting question is whether these special frequencies relate to the peak wave lengths for color vision.

A macroscopic variant of photosynthesis using the possibly existing dark photons at the flux tubes of  $B_{end} = .2$  Gauss [J15] can be imagined. The flux tubes of  $B_{end}$  could correspond to those of  $B_E$  with nominal value .5 Gauss if a weakening of the field value takes place inside living matter. Note that in case of  $h_{eff}/h \sim 10^{14}$  this field value would correspond to about  $10^{10}$  Tesla for the ordinary value of  $\hbar$  (a field strengths assignable to supernovas!) and assignable to electron Compton scale.

The sequences of these two phase transitions involved with dark metabolism would be very much analogous to ..-ATP-ADP-ATP-... "Karma's cycle". There is also a strong analogy with breathing and even sleep-wake-up cycle and longer bio-rhythms. p-Adic fractality forces to ask whether all these rhythms involve the same dark metabolic cycle but in different scales. Increase of  $h_{eff}$  indeed corresponds to an increase of "IQ" in TGD inspired theory of consciousness and its reduction to its lowering. This could quite concretely correspond the experience of becoming tired. There is also a close analogy with the state function reduction sequence in ZEO. State function reductions occur alternatively at the opposite boundaries of causal diamond (CD) of given scale and I have proposed an interpretation in terms of generalized sleep-awake cycles.

#### 7.8.4 About implications of the new view about what happens in water splitting

The standard goal in the attempts to demonstrate free energy concept is to produce over unity effect: this applies also to water splitting. If Brown gas is analogous to a fuel carrying energy, successful water splitting must burn Brown gas. Rather literally, the child is thrown out with the bath water. If the TGD based interpretation is correct, the storage of Brown gas would be the correct thing to do. One should also convincingly demonstrate that Brown gas indeed contains something else than water vapour and hydrogen, and according to Moray B. King this kind of demonstrations have been carried out.

There is an objection against the interpretation of Brown gas as fuel. The storage of energy requires energy liberation mechanisms. One can imagine several solutions.

1. The observations about  $H_{1.5}$  = stoichiometry in electron scattering and neutron diffraction indicate that the exotic water-polymers containing one dark proton per water molecule are present in water normally and their life-time is of order atto-second. If the value of  $h_{eff}$  for these water polymers increases in water splitting, the lifetime of water-polymer is expected to grow. Indeed, the simplest expectation is that the lifetime is proportional to  $h_{eff}$ . This would mean that the polymers and therefore the fuel can become stable even in human time scales. For  $h_{eff} \simeq 10^{15}h$  suggested by cold fusion and observations of Blackman about the effects of ELF radiation on vertebrate brain, the lifetime would be around millisecond, which happens to define fundamental biorhythm (kHz synchrony in brain).
2. The polymers are created in water electrolysis and energy is therefore needed. The process would be analogous to what happens in the storage of metabolic energy to biopolymers involving also splitting of water (photosynthesis is the simplest example). Cold fusion, which involves also electrolysis, is one natural candidate for the process liberating the energy.
3. Another possible energy source are the magnetic bodies of plasmoids identified in TGD framework as candidates for primitive life forms. Plasmoids have been reported to be an outcome of the water splitting and correspond to charged water clusters. Plasmoids are typically modelled as tori and the structure of dipole magnetic field is essentially that of torus so that a connection with the notion of magnetic body emerges. Magnetic body of the system serves as a natural fuel tank in TGD inspired energy technology allowing the energy to flow to the system from larger magnetic bodies. The energy itself could originate from Sun - either as photons or as charged particles transforming to dark phase with large Planck constant at the magnetic bodies. There would be a strong analogy with photosynthesis.

### 7.8.5 Lightnings and life

One expects that the phase transition  $h \rightarrow h_{eff}$  takes place as plasma phase is generated. Also the formation of plasma clusters could correspond to this of phase transitions. Ball lightnings could be seen as plasmoids for which this phase transition occurs continually as they move in air.

Lightning itself could be seen as a plasmoid travelling downwards as a di-electric breakdown near the outer surface of plasmoid, where the electric field is above the critical value for di-electric breakdown. In di-electric breakdown dark phase of matter would be generated and transform to ordinary phase with scaled up p-adic length scale so that ZPKE would be liberated and the plasmoid would preserve its high temperature. The plasmoid would propagate along path with average length of  $L = 45$  m after which it would become unstable against decay producing one or more baby plasmoids. The branching tree represents a sequence or generations of plasmoids replicating in the node of this tree.

This picture conforms with the proposal that life involves in an essential manner dark matter realised as large  $h_{eff}$  phases. The phase transition reducing  $h_{eff}$  back to  $h$  and increasing p-adic prime would provide metabolic energy for primordial life forms. Solar radiation should induce the reduction of the p-adic prime  $p$  characterizing the resulting space-time sheet to its normal value.

If the transition liberating ZPKE occurs routinely in living matter as basic step of metabolism, also the reverse phase transition must take place. The simplest possibility is that solar radiation with preferred frequency induces the transition increasing  $n = 2^k$  back to its original value and reducing the p-adic prime by factor  $2^{-k}$ . The  $ADP \rightarrow ATP$  process could involve this process. Therefore the fundamental role of the metabolic energy feed would be to bring back the system back to the large  $\hbar$  state with smaller value of  $p$  so that its size is not changed.

### 7.8.6 Could electrolysis alone produce energy?

The obvious question is whether this process can be used to produce energy continually by recycling the water. This is possible if water can be returned to its original state without feeding energy. This is not the case. The point is that the scaling up of the size of the p-adic space-time sheet carrying water clusters must be undone and this requires compression and therefore energy. Believers in ZPE would suggest that the return to the original state takes place spontaneously by extraction of vacuum energy. One can however imagine an open system in which the water that comes in is not circulated and takes the role of fuel.

The formation nuclei formed in cold fusion has been reported in electrolysis and one can also imagine the possibility that the formation of dark phase of matter makes possible cold fusion. The proposed phase transition alone does not provide any obvious mechanism of cold fusion. One however expects more general phase transitions to dark matter be present already in water.

1. For instance, the phase transition increasing the value of  $h_{eff}$  for the electroweak field body of nucleus could increase the weak length scale from  $10^{-17}$  meters to about atomic length scale and below this scale weak bosons would be effectively massless and weak interactions would become strong. This together with nuclear string model inspires a possible model for how cold fusion could proceed [L3].
2. An alternative option is based on the formation dark protons with Compton length or order atomic length scale. In [L3] a more detailed quark level mechanism for how this could allow to overcome Coulomb wall in H-D cold fusion is considered. The idea is simple: increase of Planck constant zooms the space-time sheets of proton and quarks to atomic size so that the target deuteron finds itself in the interior of dark proton or one of quarks. Also anomalous selection rules explaining the absence of high energy neutrons and gamma rays are considered.

### 7.8.7 Comment about hydrinos

Randell Mills [D23] has claimed on basis of published experimental findings that hydrogen atom allows what he calls hydrino states. For these states the principal quantum number  $n$  characterizing the energy of the state completely is replaced with its inverse  $n \rightarrow 1/n$ . This implies that the binding energy spectrum  $E \propto 1/n^2$  is reverted to  $E \propto n^2$ . A more general hypothesis is that



scaling  $E_n \propto 1/n^2 \rightarrow m^2/n^2$  takes place. The most probable reason for not taking the claim seriously is that neither Schrödinger equation or Dirac equation allows this kind of states.

Could non-standard value of Planck constant explain the claim of Mills?

1. The naive approach would just replaced  $h$  with  $h_{eff} = mh$  in the formula for the binding energies. The proportionality  $1 \propto 1/h^2$  would imply the reduction of the binding energies by factor  $1/m^2$  rather than its increase by factor  $m^2$ . This naive modification of the basic formulas is however not consistent with the fact that the formula for the binding energy is non-perturbative as the fact that binding energy becomes infinite at the limit  $h \rightarrow 0$ . One must modify Schrödinger equation itself rather than only the quantum numbers appearing in it.
2. I have considered the possibility that the introduction of large Planck constant  $h_{eff} = mh$  corresponds to  $1/m$ -fractionization for quantum numbers and that anyons for which this fractionization takes place could be understood in TGD framework. One could start from fractionization for the angular momentum and the radial "momentum"  $n$ . Replacing  $n$  by  $n/m$  one indeed obtains formula  $E_n \rightarrow m^2 E_n$  more general than but consistent with that of Mills. One might hope that a modification of Schrödinger equation gives this result at least approximately.
3. One can indeed consider a modification of the Laguerre equation for the radial part of the electron's wave function in hydrogen atom with quantum Laguerre (q-Laguerre) equation. This is well-motivated if  $h_{eff} = mh$  corresponds to  $1/m$ -fractionization for quantum numbers and this is one of the basic ideas related to the interpretation of  $h_{eff}$  hierarchy. I have studied q-Laguerre numerically for years ago ([http://www.tgdtheory.fi/public\\_html/freenergy/freenergy.html#freenergy](http://www.tgdtheory.fi/public_html/freenergy/freenergy.html#freenergy) [K78]). The formula of Mills can be produced approximately for  $m > 2$  but not for  $m = 2$ . Hence the scaling of the ground state binding energy by 4 cannot be understood unless one assumes that it is produced from  $n = 2$  state for  $m = 4$ .

The connection with hierarchy of Planck constants and fractionization of quantum numbers is far from being well understood so that q-Laguerre equation could be also seen as an independent hypothesis. q-Laguerre equation is application of quantum group concept closely related to von Neuman algebras known as hyper-finite factors of type  $II_1$  (HFFs) providing alternative mathematical framework for quantum theory. In TGD framework [K86] these algebras relate naturally to the notion of finite measurement resolution. The question is whether there really is a connection between finite measurement resolution realized in terms quantum group concept and inclusions of HFFs and hierarchy of Planck constants.

At the level of numbers the correspondence would mean that quantum group characterized by quantum phase  $q = \exp(i2\pi/n)$ ,  $n = 3, 4, 5, \dots$  corresponds to  $h_{eff} = nh$  and to a discretization of angle variables so that only the phases  $q^k = \exp(i2\pi k/n)$  appear in the phase resolution used (in purely p-adic context only the phases make sense, not angles). Note that  $n = 2$  is not in the series of the allowed quantum phases: therefore it is not surprising that  $m = 2$  is problematic in q-Laguerre equation.

A strong objection against this proposal is that all previous arguments suggest rather large values of  $h_{eff}/h$ : now the values would be rather small. My personal guess is that the electrolysis effects found by Mills can be explained by the general model already discussed without hydrino hypothesis.

### 7.8.8 Does dark biology represent pre- or post-biotic evolution?

The discovery of dark proton realization of genetic codons [L3, K32] was an accident and I am still puzzled about whether the vertebrate genetic code can really emerge from dark nuclear physics or is it only a curiosity or self deception. The first interpretation for the dark code is as a code associated with prebiotic evolution [K27]. This is suggested by the enormous simplicity for the analogs of counterparts of linear biomolecules, and the fact that the utilization of metabolic energy means that these "molecules" decay to ordinary water. In this view life would have migrated from dark space-time sheets to visible space-time sheets. This higher level life would be gradually

migrating to lower levels in the hierarchy and taking visible matter to its control and that biological evolution represents a step in this process.

There are however some objections against this view. The dark code corresponds to vertebrate code, which can be seen as an outcome of along genetic evolution. There are also other codes, which are less perfect (these are discussed in [K18] representing a number theoretic approach to genetic code). For instance, the meaning of the codeword is context dependent for some codons and Peter Gariaev has proposed that this context dependence is a more general phenomenon. One would expect that prebiotic code is much simpler than genetic code and I have considered a model for how genetic code might have emerged from more primitive codes with 4 and 16 code words as a "product code" [K18, K27].

These objections inspire the question whether life could migrate from lower to higher scales. The dark genetic code would in this framework correspond to the emergence of a new level in evolution - perhaps identifiable as cultural evolution. This would explain why dark variant of the genetic code corresponds to vertebrate code. One could also solve Fermi paradox [K85] due to the fact that no signs of intelligent life have been observed in cosmos and probabilistic estimate suggests that cosmos is full of life. The answer could be very simple: in some stage the civilization transforms to dark matter invisible to us! The civilizations are there but living on magnetic flux quanta and probably communicate with us telepathically. The higher evolutionary level would also conform with the fact that the spatial and temporal scales of consciousness are much longer than for the consciousness assignable to visible manner. This could allow also to understand also the mystery of crop circles. To my opinion many of them are genuine, and the interpretation as some kind of cognitive representations analogous to those realized in brain is highly suggestive. Certainly these representations would represent mental images of conscious entities, which are at higher evolutionary level than us [K19, K20].

Many great leaps in evolution have occurred via crisis periods involving extinction. Could it be that gradual transition to dark matter based life could begin as a response to the recent crises of human kind? The gradual transition of life to the dark matter level would indeed solve the energy problem by coupling us to the energy sources assignable to the dark matter hierarchy at various magnetic bodies. It would also solve the problem caused by the climate warming if it is indeed due to the liberation of CO<sub>2</sub> as fossil fuels are used. The dark matter "molecules" as analogs of biomolecules and hydrocarbons would produce only water when used.

What has been bothering me somewhat are the messianic elements of free energy movement: something totally new is believed to be emerging even at the level of consciousness and ethics and moral rules. Skeptic scientist finds it difficult to accept the idea that new form of energy could have so wide implications: the fundamental problems of the society relate to ethics and moral. On the other hand, if one interprets free energy phenomena as manifestations of post-biotic life forms realizing genetic code at the level of dark matter, it becomes possible to defend the messianic view about free energy. The transition to dark matter dominated world would mean also leap in the level of consciousness.

The belief in ZEP has also some features that worry me. I believe that there is some great intuition behind this view but to me its realisation in terms of ZEP is wrong thing to do: the existing mathematical physics simply fails to provide the needed language and concepts. My own proposal is zero energy ontology (ZEO) in which physical states are replaced with physical events and continual re-creation becomes possible without giving up the symmetries and laws of physics.

I find it also alarming that some advocates of free energy also have a hostile attitude towards science. This is easy to understand as a reaction to the arrogant attitude of the academic world towards free energy and actually all visions challenging the basic dogmas of the standard science. Christianity emerged as the Roman Empire collapsed and something similar seems to be happening now: at this time free energy movement might take the role of Christianity. It would be a pity if also now blind beliefs would replace rational thinking for almost two millennia.



## Chapter 8

# Ufos, Aliens, and the New Physics

### 8.1 Introduction

My personal interest in UFOs and extraterrestrials was stimulated by a TV document for almost decade ago claiming that the locations of UFO observations seem to correlate with lines of tectonic activity. Michael Persinger's work about UFO experiences was also very stimulating. The realization that crop circles are probably not hoax led to a development of rather unconventional ideas about life forms possibly responsible for the generation of crop circles.

What are UFOs? What are aliens? The attempt to answer these basic questions requires an answer to a more general question: What is life. During the last decade I have developed rather an elaborate theory of consciousness and applied it to the modelling of living matter as a macroscopic quantum system. The new view about space-time, time and consciousness allows also to develop ideas about UFOs and aliens, in particular about possible manners by which highly developed civilizations could receive information about remote parts of the Universe and to get contact with other civilizations.

In this chapter, which is actually slightly modified popular article, I try first to summarize the TGD based view about consciousness and living systems. The basic notions are many-sheeted space-time, topological quantization and magnetic body, p-adic physics as physics of intentionality and cognition, and basic ideas of TGD inspired theory of consciousness. Time mirror mechanism is a basic mechanism in TGD inspired theory of consciousness and it has also technological applications including instantaneous remote sensing of geometric past, communications with geometric past, and instantaneous remote utilization of energy, and perhaps even remote induction of simple life forms, about which simplest are perhaps plasmoids. The intelligent looking light balls reported repeatedly by UFO experiencers are indeed identifiable as plasmoids and quite recent experimental findings demonstrate that plasmoids satisfy the basic criteria justifying their identification as simple life forms.

TGD suggests also a mechanism making possible to reduce gravitational and inertial masses of space-ships so that they would behave like very light system as observations indeed suggest. Plasmoids could be living space-ships able to draw their energy from environment by the time mirror mechanism. It however seems that the highly developed civilizations would probably not see the trouble to travel to distant galaxies since it is un-necessary, and the finiteness of light velocity in any case would pose very strong limitations on what they could achieve in this manner.

Chilbolton and Crabwood crop circles can be interpreted as messages telling basic facts about the civilization responsible for their construction. Chilbolton message is constructed using the same format as Arecibo message and tells that both Earth, Mars, and Jupiter are colonized. These crop circles might be interpreted as hints about the existence of intra-terrestrial/planetary life and this inspired a model for pre-biotic evolution allowing also a model for the evolution of genetic code. The highly advanced civilization could be identified as either intelligent intra-planetary or as ourselves in the geometric future using a technology based on time mirror mechanism to construct crop circles and using less intelligent intra-terrestrial plasmoids to construct the crop circles. Sun is depicted to have a smaller size as in Arecibo message, and Crabwood message came one year and one day after the Chilbolton message: these hints allow to make estimate about the

temporal distance of this civilization of the geometric future from us.

The hypothesis about hierarchy of macroscopic quantum phases characterized by arbitrarily large values of Planck constant [K23, K21, K22] resolved the long standing problem of interpreting properly the predicted long ranged classical weak and color fields, and induced a great leap forward in the evolution of TGD based view about consciousness and life [K27]. This progress has motivated the insertion of some comments relating to dark matter hierarchy also in this chapter.

The appendix of the book gives a summary about basic concepts of TGD with illustrations. There are concept maps about topics related to the contents of the chapter prepared using CMAP realized as html files. Links to all CMAP files can be found at <http://www.tgdtheory.fi/cmaphtml.html> [L8]. Pdf representation of same files serving as a kind of glossary can be found at <http://www.tgdtheory.fi/tgdglossary.pdf> [L9]. The topics relevant to this chapter are given by the following list.

- Weak form of electric-magnetic duality [L30]
- Hierarchy of Planck constants [L17]
- Hyperfinite factors and TGD [L18]

## 8.2 Basic vision

The 8 online books about about TGD [K83, K62, K96, K72, K47, K95, K94, K70] and 9 books about TGD inspired theory of consciousness and quantum biology [K76, K13, K53, K11, K30, K38, K42, K69, K89] at my home page provide comprehensive (and unavoidably a little bit out of date) summary of TGD and TGD inspired theory of consciousness. The online journal JNLRMI [L1, L2] and its follower Journal of Non-locality contain several articles about TGD inspired theory of consciousness and quantum biology and its applications to remote mental interactions. Here a brief summary of what might be called basic principles is given.

### 8.2.1 Quantum-classical correspondence

The fundamental meta-level guiding principle is quantum-classical correspondence (classical physics is an exact part of quantum TGD). The principle states that all quantum aspects of the theory, which means also various aspects of consciousness such as volition, cognition, and intentionality, should have space-time correlates. Real space-time sheets provide kind of symbolic representations whereas p-adic space-time sheets provide correlates for cognition and intentions. All that we can symbolically communicate about conscious experience relies on quantal space-time engineering to build these representations. What makes possible to have even space-time correlates of quantum jumps and quantum jump sequences classical non-determinism of the basic variational principle determining the dynamics of space-time sheets and inherent determinism of p-adic variants of field equations.

### 8.2.2 Classical physics as exact part of quantum theory

In TGD Universe space-times are 4-surfaces in the 8-dimensional space  $H = M_+^4 \times CP_2$  obtained by replacing the points of Minkowski space future light cone with 4-dimensional compact space  $CP_2$  having extremely small size of order  $10^{-30}$  meters (see Fig. 8.7). Classical physics corresponds to the dynamics of space-time surfaces determined by the criticality in the sense of having an infinite number of deformations for which the second variation of Kähler action vanishes.

The expectation is that the number of critical deformations defining the symmetries is infinite and conformal symmetries are in question. The conformal algebras would form an infinite hierarchy of sub-algebras with generators labelled by integers proportional to an integer  $n = 1, 2, \dots$ . One would have  $n$  conformal equivalence classes of space-time surfaces connecting given 3-surfaces at the boundaries of CD and  $n$  would define Planck constant  $h_{eff} = n \times h$  labelling the hierarchy of dark matters (see fig. <http://www.tgdtheory.fi/appfigures/planckhierarchy.jpg>, which is also in the appendix of this book).

This dynamics have several unconventional features basically due to the possibility to interpret the Kähler action as a Maxwell action expressible in terms of the induced metric defining classical gravitational field and induced Kähler form defining a non-linear Maxwell field not as such identifiable as electromagnetic field however.

### Topological field quantization and the notion of many-sheeted space-time

Quantum classical correspondence is very powerful principle. For instance, the criticality of Kähler action serving as the basic variational principle can be interpreted as a space-time representation for the quantum criticality of TGD Universe. Hence the solutions of field equations correspond asymptotically to self-organization patterns for which dissipation represented by Lorentz 4-force vanishes. This provides the physical intuition which has led to a discovery of extremely general solution families of field equations. It might even be that the classical field equations determining space-time surfaces are exactly solvable. The study of field equations leads to general classification of the phases of matter and simple topological criterion differentiates between living and "dead" matter [K10, K51] .

#### 1. Topological field quantization

The compactness of  $CP_2$  implies the notions of many-sheeted space-time and field quantization. Topological field quantization means that various classical field configurations decompose into topological field quanta. Space-time becomes many-sheeted (see Fig. 8.7). One can see space-time as a gigantic Feynman diagram with lines thickened to 4-surfaces. Criticality implies that only selected field configurations analogous to Bohr's orbits are realized physically so that quantum-classical correspondence becomes very predictive. An interpretation as a 4-D quantum hologram is a further very useful picture [K33] but will not be discussed in this chapter in any detail. One implication of many-sheetedness is the possibility of macroscopic quantum coherence.

Topological field quantization implies that the field patterns associated with material objects form extremely complex topological structures which can be said to belong to the material objects. The notion of field body, in particular magnetic body, typically much larger than the material system, differentiates between TGD and Maxwell's electrodynamics, and has turned out to be of fundamental importance in the TGD inspired theory of consciousness. One can say that field body provides an abstract representation of the material body.

Space-time sheets topologically condense to larger space-time sheets by wormhole contacts (see fig. <http://www.tgdtheory.fi/appfigures/wormholecontact.jpg> or fig. 10 in the appendix of this book) which have Euclidian signature of metric. This implies causal horizon at which the signature of the induced metric changes from Minkowskian to Euclidian. This forces to modify the notion of sub-system. What is new is that two systems represented by space-time sheets can be unentangled although their subsystems bound state entangle with the mediation of the join along boundaries bonds connecting the boundaries of sub-system space-time sheets (see Fig. 8.7). This is not allowed by the notion of subsystem in ordinary quantum mechanics. This notion in turn implies the central concept of fusion and sharing of mental images by entanglement making possible telepathic communications of mental images over arbitrarily long distances.

### The possibility of negative energies

A further prediction derives from the fact that space-time is 4-surface rather than an abstract manifold. Energy momentum tensor of general relativity is replaced by a collection of conserved energy and momentum currents, which are 4-vector fields. This makes the notions of energy and momentum precisely defined but also implies that the sign of energy and momentum depend on the time-orientation of the space-time sheet. Negative energies become therefore possible somewhat like in the lines of a Feynman diagram. Negative energy topological light rays have phase conjugate laser waves [D35, D37] as the most plausible standard physics counterparts, and play a fundamental role in quantum metabolism as a kind of quantum credit card [K34] . They generate also time like entanglement which corresponds to a formation of new kind of bound states.

Negative energies might be possible even for ordinary particles and could mean dramatic deviation from the standard quantum theory. The roles of annihilation and creation operators have changed for negative energy space-time sheets. This would mean that operator combinations

involving both annihilation and creation operators would generate states involving positive and negative energy space-time sheets. One can even imagine that an intentional action could create states with vanishing net quantum numbers and that positive and negative energy particles could be separated from each other.

Phase conjugate waves [D35, D37] discovered by Zeldovich and his colleagues at seventies in Russia are counterparts of negative energy photons. They represent signals propagating to the geometric past and it is possible to understand their strange properties if one assumes that they have negative energies. Kozyrev was probably the first one to observe phase conjugate waves from distance astrophysical and propagating towards geometric past [H31]. Sadly, standard physicists are not yet mature to realize how far reaching this discovery is or not to even take it seriously.

### TGD Universe is quantum spin glass

Since Kähler action is Maxwell action with Maxwell field and induced metric expressed in terms of  $M_+^4 \times CP_2$  coordinates, the gauge invariance of Maxwell action as a symmetry of the vacuum extremals (this implies is a gigantic vacuum degeneracy) but not of non-vacuum extremals. Gauge symmetry related space-time surfaces are not physically equivalent and gauge degeneracy transforms to a huge spin glass degeneracy. Spin glass degeneracy provides a universal mechanism of macro-temporal quantum coherence and predicts degrees of freedom called zero modes not possible in quantum field theories describing particles as point-like objects. Zero modes are identifiable as effectively classical variables characterizing the size and shape of the 3-surface as well as the induced Kähler field.

### Long range classical weak and color fields

Geometrization of classical fields means that various classical fields are expressible in terms of imbedding space-coordinates and are thus not primary dynamical variables. This predicts the presence of long ranged weak and color (gluon) fields not possible in standard physics context.

The proper interpretation of these fields has been the most difficult challenge that I have encountered during the development of TGD. So difficult that it took not less than 24 years before I was mature to realize that these fields can be assigned to a fractal hierarchy of copies of standard model physics, in particular the physics based on different value of Planck constant and having interpretation in terms of dark matter hierarchy. A good metaphor for the TGD universe is as an inverted Mandelbrot fractal so that the increase (rather than decrease) of the resolution scale reveals endlessly new and larger structures due to the scaled up variants of standard physics not possible to see in shorter length scales.

The exotic weak and color forces appear already in atomic length scales and force to modify the view about nuclear physics and condensed matter physics [K71, K23]. The charge entanglement induced by  $W$  MEs defines the most promising candidate for the general mechanism for how magnetic bodies perform quantum control of biological bodies: for instance, the model of nerve pulse generation represents an application of this [I37] [K57]. Chiral selection in living matter can be seen as a direct evidence for the exotic weak forces operating at the level of dark matter [K27]. Classical color force in turn is the backbone in the model of color vision [K29]: colors correspond to increments of color quantum numbers in this model.

### 8.2.3 p-Adic physics as physics of cognition and intentionality

p-Adic number fields  $R_p$ , one for each prime  $p$ , and real numbers  $R$  are completions of rational numbers. p-Adic numbers differ from real numbers in that notions of distance, nearness, and continuity are completely different. p-Adic field equations are also inherently non-deterministic. For these reasons p-adic numbers are excellent candidates for modelling of space-time correlates of cognition and intention.

#### p-Adic numbers

Like real numbers, p-adic numbers can be regarded as completions of the rational numbers  $q = r/s$  ( $r$  and  $s$  integers) to a larger number field allowing the generalization of differential calculus. Each prime  $p$  defines a p-adic number field allowing the counterparts of the usual arithmetic operations.

A basic difference between real and p-adic numbers is that the notions of distance are quite different. Any rational can be written as  $q = p^k \times r/s$  where  $r$  and  $s$  are not divisible by  $p$ . The p-adic norm in  $R_p$  (analogous to absolute value in real context) is  $|q|_p = p^{-k}$ . In particular for  $q = p^k$  the norm is  $p^{-k}$  and approaches zero when  $k$  becomes infinite. Real norm would become infinite at this limit. Therefore p-adically infinitesimal corresponds to infinite in the real sense.

p-Adic numbers allow the generalization of the differential calculus. The basic rules of the p-adic differential calculus are the same as those of the ordinary differential calculus. There is however one important new element: the set of the functions having vanishing p-adic derivative consists of so called pseudo constants which are piecewise constant function. In the real case only constant functions have vanishing derivative. This implies that p-adic differential equations are non-deterministic. This non-determinism is identified as a counterpart of the non-determinism of cognition, imagination, and intentionality.

### p-Adic length scales and p-adic cognitive codes

Parallel space-time sheets with distance about  $10^4$  Planck lengths form a hierarchy. Each material object (...atom, molecule, ..., cell,...) corresponds to this kind of space-time sheet. The p-adic primes  $p \simeq 2^k$ ,  $k$  prime or power of prime, characterize the size scales of the space-time sheets in the hierarchy. The p-adic length scale  $L(k)$  can be expressed in terms of cell membrane thickness as

$$L(k) = 2^{(k-151)/2} \times L(151) \quad , \quad (8.2.1)$$

where the p-adic length scale  $L(151)$  and all p-adic length scales above electron length scale  $L(127)$  were identified erratically in all writings about TGD before 2014. This deserves some comments.

1. The wrong identification was  $L(151) \simeq 10$  nm implying wrong identification of other scales above  $L(127)$  since I have calculated them by scaling  $L(151)$  by an appropriate power of two. What I have denoted by  $L(151)$  is actually obtained by scaling the Compton length  $L_e(127) = \hbar/m_e$  by  $2^{(151-127)/2}$  and therefore electrons Compton scale if it would correspond to  $k = 151$ . Since the mass of electron from p-adic mass calculations is given by  $m_e = \sqrt{5+X}\hbar/L(127)$ , the correct identification of  $L(151)$  would be

$$L(151) = 2^{(151-127)/2} L(127) = 2^{(151-127)/2} L_e(151)/\sqrt{5+X} = 10/\sqrt{5+X} \text{ nm} \quad , \quad 0 \leq X \leq 1 \quad .$$

Here  $X$  denotes the unknown second order contribution of form  $X = n/M_{127}$ ,  $n$  integer, to the electron mass, and in the first approximation one can take  $X = 0$  - the approximation is excellent unless  $n$  is very large. In the sequel I will try to use the shorthand  $L_e(k) = \sqrt{5}L(k)$  but cannot guarantee that the subscript "e" is always present when needed: it is rather difficult to identify all places where the earlier erratic definition appears. I can only apologise for possible confusions.

2. This mistake has no fatal consequences for TGD inspired quantum biology. Its detection however provides a further support for the speculated central role of electron in living matter. Since the scales obtained by scaling the electron Compton scale seem to be important biologically (scaled up Compton scale  $\sqrt{5}L(151)$  corresponds to cell membrane thickness), the conclusion is that electrons - or perhaps their Cooper pairs - play a fundamental role in living matter. The correct value of  $L(151)$  is  $L(151) = 4.5$  nm, which is slightly below the p-adic length scale  $L_e(149) = 5$  nm assigned with the lipid layer of cell membrane.
3. I have also assigned to electron the time scale  $T = .1$  seconds defining a fundamental biorhythm as a secondary p-adic time scale  $T_2(127) = \sqrt{M_{127}}T(127)$ . The correct assignment of  $T = .1$  seconds is as the secondary Compton time  $T_{2,e}(127) = \sqrt{M_{127}}T_e(127)$  of electron: secondary p-adic time scale is  $T_2(127) = \sqrt{M_{127}}T(127)$  and corresponds to  $T_{2,e}(127)/\sqrt{5} = .045$  seconds and to  $f(127) = 22.4$  Hz.



These are so called primary p-adic length scales but there are also n-ary p-adic length scales related by a scaling of power of  $\sqrt{p}$  to the primary p-adic length scale. The model for photosynthesis [K34] gives additional support for the importance of also n-ary p-adic length scales  $L_e(n, k) = 2^{(n-1)k/2}L_e(k)$  so that the relevant p-adic length scales would come as half-octaves in a good approximation but prime and power of prime values of  $k$  would be especially important. p-Adic length scale hypothesis allows to quantify the notion of many-sheeted space-time and make rich spectrum of predictions such as p-adic frequencies  $f(k) = c/L(k)$  and corresponding energies (see fig. <http://www.tgdtheory.fi/appfigures/manysheeted.jpg> or fig. 9 in the appendix of this book).

p-Adic cognitive are realized as bit sequences defined by field patterns such that duration of codeword is  $T_e(n, k) = L_e(n, k)/c$  and the number  $k_1$  of bits is a factor of  $k$ . For prime values of  $k$  the number of bits is maximal, which is one reason for why they are in special position. Genetic code correspond to  $k_1 = 6$  and memetic code to  $k_1 = 126$  [K31]. These cognitive codes would be universal and especially interesting concerning communications with extraterrestrial civilizations since they correspond to precisely defined frequencies.

### Generalization of number concept

The basic ingredient is the new view about numbers: real and p-adic number fields are glued together like pages of a book along common rationals representing the rim of the book (see Fig. 8.7). This generalizes to the extensions of p-adic number fields and the outcome is a complex fractal book like structure containing books within books. This holds true also for manifolds and one ends up to the view about many-sheeted space-time realized as 4-surface in 8-D generalized imbedding space and containing both real and p-adic space-time sheets. The latter are interpreted as correlates for thoughts and intentions. The transformation of intention to action corresponds to a quantum jump in which p-adic space-time sheet is replaced with a real one.

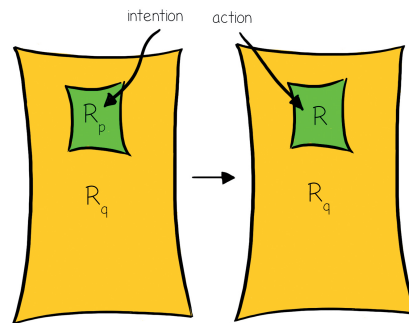

Figure 8.1: Transformation of intention to action as real-to-p-adic transformation and realization of intention as action as its reversal.

### p-Adically infinitesimal is infinite in real sense

One implication is that the rationals having short distance p-adically are very far away in real sense. This implies that p-adically short temporal and spatial distances correspond to long real distances and that the evolution of cognition proceeds from long to short temporal and spatial scales whereas material evolution proceeds from short to long scales. First a rough sketch is generated and then smaller and smaller details are added gradually. Together with the non-determinism of p-adic field equations this explains the long range temporal correlations (ability to realize rough plans) and apparent local randomness of intentional behavior.

The fact that p-adically infinitesimal distances correspond to infinite distances in real sense means that continuous p-adic space-time sheets have a literally infinite size. Thus cognitive body is of infinite size and our thoughts have infinite size in real sense. This turns upside down the

usual view about brain as seat of thoughts and forces a new view about conscious existence. Particular biological life cycle is like turning attention to a particular biological body serving as motor instrument and sensory receptor. After biological death the attention turns to some other biological body perhaps in some other galaxy. This allows also a fresh look to what one means by extraterrestrial and aliens.

### **p-Adic fractal statistics as a signature of intentionality**

The failure of the real statistics and its replacement by p-adic fractal statistics for time series defined by varying number  $N$  of measurements performed during a fixed time interval  $T$  allows very general tests for whether the system is intentional and what is the p-adic prime  $p$  characterizing the "intelligence quotient" of the system. The replacement of  $\log(p_n)$  in the formula  $S = -\sum_n p_n \log(p_n)$  of Shannon entropy with the logarithm of the p-adic norm  $|p_n|_p$  of the rational valued probability allows to define a hierarchy of number theoretic information measures which can have both negative and positive values and one can assign to rational valued probabilities a unique p-adic entropy  $S_p$  as maximally negative entropy and identify it as information associated with the entanglement. This kind of entanglement is naturally interpreted as bound state entanglement.

### **8.2.4 The core ideas of TGD inspired theory of consciousness and quantum biology**

The following ideas of TGD inspired theory of consciousness and of quantum biology are the most relevant ones for what will follow.

#### **Quantum jump as moment of consciousness and the notion of self**

"Everything is conscious and consciousness can be only lost" is the briefest manner to summarize TGD inspired theory of consciousness. Quantum jump as a moment of consciousness and the notion of self are key concepts of the theory besides quantum mechanical concepts like entanglement (see Fig. 8.7) and bound state (electron and proton in hydrogen atom provide the basic example of bound state. Generation of bound state quantum entanglement with environment means that the system loses its consciousness.

Moment of consciousness corresponds to single quantum jump, which has a complex anatomy not discussed here. Self is a system able to avoid bound state entanglement with environment and can be formally seen as an ensemble of quantum jumps. The contents of consciousness of self are defined by the averaged increments of quantum numbers and zero modes (sensory and geometric qualia). Moments of consciousness can be said to be the counterparts of elementary particles and selves the counterparts of many-particle states, both bound and free.

The selves formed by macro-temporal quantum coherence are in turn the counterparts of atoms, molecules and larger structures. Macro-temporal quantum coherence effectively binds a sequence of quantum jumps to a single quantum jump as far as conscious experience is considered. The idea that conscious experience is about changes amplified to macroscopic quantum phase transitions, is the key philosophical guideline in the construction of various models, such as the model of qualia, the capacitor model of sensory receptor, the model of cognitive representations, and declarative memories.

Selves can have sub-selves and self experiences them as mental images. The TGD based notion of sub-system allows sub-selves to entangle and this corresponds to the fusion of mental images: this occurs for instance in stereovision. In the case that the systems in question represents a mental image, entanglement means fusion and sharing of mental images. The implication is that the contents of our consciousness is not so private than we have accustomed to think. For instance, shared mental images could be behind the development of moral rules and be crucial for the existence of society.

#### **Macro-temporal quantum coherence**

Macro-temporal quantum coherence is second consequence of the spin glass degeneracy [K33]. It is essentially due to the formation of bound states and has as a topological correlate the formation of

join along boundaries bonds connecting the boundaries of the component systems. During macro-temporal coherence quantum jumps integrate effectively to single long-lasting quantum jump and one can say that system is in a state of oneness, eternal now, outside time. Macro-temporal quantum coherence makes possible stable non-entropic mental images. Negative energy topological light rays (MEs) are one particular mechanism making possible macro-temporal quantum coherence via the formation of bound states, and remote metabolism and sharing of mental images are other facets of this mechanism.

### Space-time as a 4-dimensional living organism

p-Adic physics as physics of intentionality and cognition is a further key idea of TGD inspired theory of consciousness. p-Adic space-time sheets as correlates for intentions and p-adic-to-real transformations of them as correlates for the transformation of intentions to actions allow deeper understanding of also psychological time as a front of p-adic-to-real transition propagating to the direction of the geometric future. Negative energy MEs are absolutely essential for the understanding of how precisely targeted intentionality is realized.

Entire 4-dimensional space-time can be said to be living and self-organizing structure which changes in each quantum jump. This means that our geometric future and past contain civilizations and in principle we could communicate with ourselves of geometric future. Even our own biological bodies can be lived through many times although one must assume that there is a kind of "dead time" during which large changes in the immediate geometric past are not possible: for instance, a different decision in the geometric youth could suddenly and profoundly change our life in geometric now.

### Mersenne hypothesis

The scale of the Josephson frequencies assignable to a given neuron is determined by the value of Planck constant. TGD inspired quantum biology and number theoretical considerations suggest preferred values for  $r = \hbar/\hbar_0$ . For the most general option the values of  $\hbar$  are products and ratios of two integers  $n_a$  and  $n_b$ . Ruler and compass integers defined by the products of distinct Fermat primes and power of two are number theoretically favored values for these integers because the phases  $\exp(i2\pi/n_i)$ ,  $i \in \{a, b\}$ , in this case are number theoretically very simple and should have emerged first in the number theoretical evolution via algebraic extensions of p-adics and of rationals. p-Adic length scale hypothesis favors powers of two as values of  $r$ .

One can however ask whether a more precise characterization of preferred Mersennes could exist and whether there could exist a stronger correlation between hierarchies of p-adic length scales and Planck constants. Mersenne primes  $M_k = 2^k - 1$ ,  $k \in \{89, 107, 127\}$ , and Gaussian Mersennes  $M_{G,k} = (1+i)k - 1$ ,  $k \in \{113, 151, 157, 163, 167, 239, 241, \dots\}$  are expected to be physically highly interesting and up to  $k = 127$  indeed correspond to elementary particles. The number theoretical miracle is that all the four p-adic length scales with  $k \in \{151, 157, 163, 167\}$  are in the biologically highly interesting range 10 nm-2.5  $\mu\text{m}$ ). The question has been whether these define scaled up copies of electro-weak and QCD type physics with ordinary value of  $\hbar$ . The proposal that this is the case and that these physics are in a well-defined sense induced by the dark scaled up variants of corresponding lower level physics leads to a prediction for the preferred values of  $r = 2^{k_d}$ ,  $k_d = k_i - k_j$ . More general prediction is  $h_{eff} = nh$ , where  $n$  is product of distinct Fermat primes and power  $2^{k_d}$ .

This proposal will be referred to as Mersenne hypothesis and it leads to strong predictions about EEG since it predicts a spectrum of preferred Josephson frequencies for a given value of membrane potential and also assigns to given value of  $\hbar$  a fixed size scale having interpretations as size scale of body part or magnetic body.

### Dark matter hierarchy, sensory representations, motor action, and metabolism

Dark matter hierarchy forces a profound reconsideration of brain metabolism and allows to develop a detailed model for how magnetic bodies use biological bodies as sensory receptors and motor instruments [K22] leading among other things to a generalization of the notion of genome.

For ordinary quantum mechanics photons at EEG frequencies correspond to ridiculously small energies. Dark matter hierarchy is accompanied by a hierarchy of EEGs and its generalizations

with the scalings of frequencies predicted to come in powers  $r = 2^{k_d}$ , where the values of  $k_d$  are fixed by Mersenne hypothesis [K22] .

The fact that arbitrarily small frequencies can correspond to energies above thermal threshold at higher levels of dark matter hierarchy implies that photons with arbitrarily low frequencies can have sizeable physical effects on matter. This conforms with the findings about the effects of ELF em fields on living matter [K22] , and these effects allow to develop a rather detailed model for EEG and identify the parts of EEG correlating with communications of sensory data to the magnetic body and with quantum control performed by the magnetic body [K22] .

The implication is that the transfer of energy between magnetic bodies and biological body could be major factor in metabolism. The question is whether the magnetic bodies provide metabolic energy for brain or utilize the metabolic energy provided by brain or both. Time mirror mechanism (see fig. <http://www.tgdtheory.fi/appfigures/timemirror.jpg> or fig. 24 in the appendix of this book) as a mechanism of intentional action would predict that magnetic body uses the metabolic resources of brain during intentional action. Together with the strange findings about ionic currents through cell membrane suggesting that ionic channels and pumps are actually ionic receptors and the ionic currents through them are only small samples about the net currents, this vision leads to a profoundly new view about brain metabolism.

## 8.3 TGD based view about life

The notions of many-sheeted space-time, magnetic body, p-adic physics as physics of intention and cognition, time mirror mechanism as a tool to realized intentional action, and classical  $Z^0$  force, are the basic elements of TGD inspired view about life (see the figures ??, <http://www.tgdtheory.fi/appfigures/manysheeted.jpg> or fig. 9, fluxquant, padictoreal in the appendix of this book).

### 8.3.1 The notion of magnetic body

The magnetic field associated with any material system is topologically quantized, and one can speak about magnetic body since one can assign given magnetic flux tube to a definite material system.

#### Magnetic body as an intentional agent

An attractive idea is that the relationship of the magnetic body to the material system is to some degree that of the manual to an electronic instrument. Magnetic body would thus allow to realize both sensory and abstract symbolic representations about the material body. Magnetic body would in this case serve as a kind of computer screen at which the data items processes in say brain are communicated either classically (positive energy MEs) or by sharing of mental images (negative energy MEs).

Magnetic body is also an active intentional agent: motor actions are controlled from magnetic body and proceed as cascade like processes from long to short length and time scales as quantum communications of desires at various levels of hierarchy of magnetic bodies. Communication occurs backwards in geometric time by negative energy MEs. Motor action as a response to these desires occurs by classical communications by positive energy MEs and as neural activities. This explains the coherence and synchrony of motor actions difficult to understand in neuroscience framework. The sizes of flux tubes are astrophysical: for instance, EEG frequency of 7.8 Hz corresponds to a wave length defined by Earth's circumference. The non-locality in the length scale of magnetosphere, and even in length scales up to light life, is forced by Uncertainty Principle alone, if taken seriously in macroscopic length scales.

#### Universal metabolic currencies

The leakage of supra currents of ions and their Cooper pairs from magnetic flux tubes of the Earth's magnetic field to smaller space-time sheets and their dropping back involving liberation of the zero point kinetic energy defines one particular metabolic "Karma's cycle". The dropping of protons from  $k = 137$  atomic space-time sheet involved with the utilization of ATP molecules is only a special instance of the general mechanism involving an entire hierarchy of zero point kinetic energies

defining universal metabolic currencies. This leads to the idea that the topologically quantized magnetic field of Earth defines the analog of central nervous system and blood circulation present already during the pre-biotic evolution and making possible primitive metabolism. This has far reaching implications for the understanding of how pre-biotic evolution led to living matter as we understand it [K27].

In many-sheeted space-time particles topologically condense at all space-time sheets having projection to given region of space-time so that this option makes sense only near the boundaries of space-time sheet of a given system. Also p-adic phase transition increasing the size of the space-time sheet could take place and the liberated energy would correspond to the reduction of zero point kinetic energy. Particles could be transferred from a portion of magnetic flux tube portion to another one with different value of magnetic field and possibly also of Planck constant  $h_{eff}$  so that cyclotron energy would be liberated. In the following only the "dropping" option is discussed.

### Dark matter hierarchy and motor control

The following general overview about quantum communication and control emerges from the model for EEG hierarchy as correlate for dark matter hierarchy discussed in detail in [K22] .

1. Cyclotron frequencies relate to the control of the biological body by the magnetic body and could be assigned with the magnetic flux sheets going through DNA since it is genome where protein synthesis is initiated and is thus the optimal intermediate step in the cellular control.
2. One of the basic functions of cell membranes is to perceive the chemical environment using various kinds of receptors as sensors. Neurons have specialized to receive symbolic representations of the sensory data of primary sensory organs about the situation in the external world. A good guess is that in this case magnetic flux quanta are hollow cylindrical structures parallel to the cell membrane associated proteins serving as Josephson junctions. Also magnetic flux tubes parallel to axon serving as templates for axons could define communication lines connecting cell membranes to the cellular magnetic body. Also synaptic contacts should involve similar magnetic flux quanta connecting them to neuronal magnetic body.
3. This picture would explain why the temperature of brain must be in the narrow range 36-37 K to guarantee optimal functionality of the organism. If interior superconductivity is lost, magnetic body receives sensory data but is paralyzed since its desires cannot be realized. If boundary superconductivity is lost, magnetic body can move but is blind.
4. In the length scales below the weak length scale  $L_w$  also charged weak bosons behave as massless particles and the exchange of virtual  $W$  bosons makes possible a non-local charge transfer. Dark quark-antiquark pairs associated with the color bonds of the atomic nuclei can become charged via the emission of dark  $W$  boson and thus produce an exotic ion. The same can happen at the higher levels of dark matter hierarchy.
5. Massless extremals (MEs, topological light rays) serve as correlates for coherent states and Bose-Einstein condensates of dark bosons. Besides neutral massless extremals (MEs) TGD predicts also charged massless extremals obtained from their neutral counterparts by a mere color rotation (color and weak quantum numbers are not totally independent in TGD framework). The second non-local quantum control mechanism is based on electromagnetic charge entanglement involving a superposition of ordinary ions/atoms and exotic ions connected by a  $W$  massless extremal joining magnetic body and biological body. In quantum jump this state would be reduced to exotic charge state with some probability increasing with the strength of the classical  $W$  field. Charged massless extremals could be seen as correlates for non-local quantum control by affecting charge equilibria whereas neutral MEs would serve as correlates for coordination and communication. Color charged MEs could also induce color charge polarization and flows of color charges and thus generate visual color qualia by the capacitor mechanism discussed in [K29] .
6. These non-local quantum mechanisms can induce or change electromagnetic polarization in turn inducing ordinary charge flows and thus making possible quantum control of nervous system by magnetic body. The generation of nerve pulse could rely on the spontaneous state

function reduction occurring for charge entangled state reducing the resting potential below the critical value by this kind of mechanism inducing charge transfer between cell interior and exterior. Also remote mental interactions, in particular telekinesis, might rely on this mechanism.

### Emergence of symbols at molecular level and new view about hydrogen bond, water, and bio-catalysts

The first questions one can ask about dark matter is "What dark atoms could be?". This question is discussed in [K21] and more thoroughly and relating it to the general model about living matter in [K40, K27, K19].

One can imagine two notions of dark atom. The first one is based on  $r^2$ -fold radial scaling of ordinary atom and predicts that energies are scaled down like  $1/r^2$ . Second is based on  $r$ -fold radial folding of the ordinary atom without changing its size. Both of these notions seem to make sense.

The radially folded atoms seems to be especially interesting biologically. The nucleus of this dark atom is ordinary whereas electrons are dark. For Mersenne hypothesis the space-time sheet associated with a dark atom is locally  $r$ -fold covering of  $M^4$ ,  $r = 2^{k_d}$ . The sheets however integrate to a single sheet globally.

Single electron states have very nearly the same energy as in the case of ordinary atoms since principal quantum number  $n$  is fractionized to  $n/r$ . Fermi statistics allows also  $N \leq r$ -electron states: this is essentially due to the degeneracy caused by the  $r$ -fold local stack structure of space-time sheets.

From the point of exterior world these atoms have an effective fractional charge  $1 - N/r$  since fine structure constant associated with the interaction of dark electron with external world is scaled down by a factor  $1/r$ .  $N = r$  corresponds to full electron shell and represents especially stable state analogous to noble gas atom or magic nucleus.

Dark N-hydrogen atoms, briefly  $H_N$ -atoms are of especial interest from the point of view of biology. One ends up with the hypothesis that  $H_r$ -atom corresponds to hydrogen atom appearing in hydrogen bond. Furthermore,  $H_N$ -atoms could define  $r$ -fold alphabet and their attachment to various bio-molecules could define letters for the names of bio-molecules.

The molecules labelled by name and conjugate name would have enhanced probability to fuse along the letters and conjugate letters ( $N_c = \lambda - N$ ): in this process one proton would be liberated and could drop to a larger space-time sheet liberating metabolic energy quantum. This process would define simultaneously the basic mechanisms of catalytic action and generation of metabolic energy quantum.  $H_N$  atoms would bring in symbolic representations and what might be called molecular sex.

The assumption that that at least part of water molecules of water in living systems could be of form  $H_N - O - H$  and  $H_{N_1} - O - H_{N_2}$  leads to a model for ordered water as water in which only  $H_r$ -atoms are bound to oxygen and to answer basic questions concerning the role of water in bio-chemistry. For instance, the question why hydration induces de-polymerization unless the water is in ordered phase can be answered. The prediction is that  $H_N - O - H$  water acts as a catalytic poison by attaching to the letters of the names of molecules and thus spoiling catalytic specificity. The identification of ordered water as the predecessor of gel-phase emerges naturally.

In this framework it is even possible to say something non-trivial about how first replicators have emerged. The new view about hydrogen bond poses very strong constraints on allowed bio-monomers. Monomers forming negatively charged polymers at the verge of stability are ideal since they define optimal targets for catalytic action.

### Magnetic Mother Gaia as conscious entity

Magnetic Mother Gaia could also form sensory and other representations receiving input from several brains via negative energy EEG MEs entangling magnetosphere with brains. The multi-brained magnetospheric selves could be responsible for the third person aspect of consciousness and for the evolution of social structures. Some aspects of remote viewing very difficult to understand if remote viewing involves only the target and viewer [J22], the successful healing by prayer and

meditation groups [J9] , and the experiments of Mark [J19] [J19] support the view that multi-brained possibly magnetospheric selves are involved. Magnetic flux tubes could function as wave guides for MEs and this aspect is crucial in the model of long term memory.

### 8.3.2 Time mirror mechanism as a fundamental mechanism transforming intentions to actions

Time mirror mechanism (see fig. <http://www.tgdtheory.fi/appfigures/timemirror.jpg> or fig. 24 in the appendix of this book) is based on the generalization of what happens in the reflection of light. Instead of reflecting in spatial direction, light propagating in the direction of past is reflected in time direction. Phase conjugate light waves can be identified as light propagating in the direction of geometric past and with its photons having negative energies. Reflected light consists in turn of ordinary positive energy photons.

#### Materialization of intentions

Long ranged electro-weak fields, in particular ELF em fields, are crucial for the TGD inspired model of brain and a natural assumption is that p-adic-real phase transitions occur also for "topological light rays" (massless extremals (MEs)).

A concrete picture about the materialization of intentions emerges, when one asks how a precisely targeted intention could be realized at the atomic or molecular level. The basic point is that molecules can only intend to make simple quantum transitions.

1. If the transition occurs to a lower energy state it can occur spontaneously whereas the transitions to a higher energy states cannot. Spontaneous transitions mask the possibly occurring intended transitions so that only the transitions which cannot occur spontaneously allow precisely targeted intention.
2. What would happen is that first a p-adic ME representing the intention to perform the transition is generated. Then p-adic ME is transformed to a real ME in quantum jump. Quite generally, it seems that intention can be realized in a precisely targeted manner only for the transitions, which cannot occur spontaneously, and thus involve the emission of negative energy MEs.
3. The generation of negative energy MEs utilizes the buy now-let others pay mechanism of metabolism, which implies extreme flexibility since system gets energy instantaneously. Of course, there must exist an unselfish self, which is able to pay and this puts severe constraints on the mechanism.
4. *W* MEs inducing charge entanglement involving exotic nuclear ionizations of opposite sign in entangled systems is especially attractive candidate for inducing generalized motor actions. The mechanism relies on the generation of classical electric fields at dark space-time sheets in turn inducing via Faraday law electric fields at space-time sheets containing the ordinary matter: this leads to generation of ordinary ohmic currents. The generation of nerve pulse could represent one example of a generalized motor action realized in this manner by magnetic body [K57] .

#### Time mirror mechanism, scalar wave pulses, and wormhole magnetic fields

Many-sheeted space-time makes possible many-sheeted lasers since cold space-time sheets can contain Bose-Einstein condensates of ions and their Cooper pairs. If the system contains population inverted many-sheeted laser for which the increment of zero point kinetic energy corresponds to the energy of photons associated with negative energy MEs, the absorption of negative energy photons gives rise to a phase transition like dropping of particles to larger space-time sheet by the induced emission mechanism, and the control signal represented by negative energy MEs can be amplified if a critical number of particles drops to the larger space-time sheet. This control mechanism allows an instantaneous motor control in which intention is transformed to desired represented by negative energy MEs and generates in geometric past a reaction representing the desired response, say neuronal activity giving rise to a motor action. This process probably involves entire hierarchy

of magnetic selves realizing their intentions as desires communicated to lower level magnetic selves and the lowest level corresponds to the regions of brain responsible for liberating metabolic energy.

The simplest possibility is that the transformation of the intention to action corresponds to p-adic-to-real phase transition for negative energy topological light ray. It however seems that generation of p-adic scalar wave pulse transformed to real one is more promising mechanism. When scalar wave pulse moves in matter, charges end up to the space-time sheet of the scalar wave pulse and accelerate without dissipation. Instead of brehmstrahlung the accelerated charges emit negative energy "acceleration radiation" having negative energy MEs as space-time correlates. Since dissipation is negligible this leads to a generation of a strong negative energy signal. The resulting negative energy photons in turn induce the phase-transition like dropping of particles of population inverted many-sheeted laser to larger space-time sheets liberating a beam of positive energy photons which is much more intense than the control signal consisting of negative energy photons. A good guess is that scalar wave pulses provide a fundamental control mechanism in living matter, and that nerve pulse represents only a special case of this control mechanism.

Intentions could be transformed also to actions by generation of magnetic flux tubes: so called wormhole magnetic fields [K87] correspond to pairs of magnetic flux tubes having opposite time orientations and therefore also opposite energies. Wormhole magnetic fields could be created by first generating their p-adic counterparts, and then transforming them to their real counterparts in quantum jump. The phase transition like changes of EEG spectrum involving emergence or disappearance of EEG band might be due to the generation of wormhole magnetic fields giving rise to EEG resonance frequencies via cyclotron transitions and thus represent motor actions of magnetic body [K22] .

### 8.3.3 Applications of time mirror mechanism

Time mirror mechanism has become a corner stone of TGD inspired theory of consciousness and biological applications translate easily to technological applications, which provide a fresh new about how advanced civilizations might study the surrounding cosmos.

#### Biological applications

Long term memory, sensory perception, and realization of intentions as action, in particular motor actions rely on time mirror mechanism. The idea is simple. To remember is to "see" the brain of the past. Ordinary seeing is based on reflection of light on an object. Seeing the brain of past is based on reflection of light in time direction by mirror mechanism. The same mechanism explains remote mental interactions. Now reflection occurs some other brain or some other system containing population inverted lasers.

The strange time delays associated with active and passive aspects of consciousness discovered by Libet [J20] can be interpreted as due to the finiteness of light velocity and astrophysical size of the magnetic body, and thus lend support for the notions of magnetic body and time mirror mechanism.

Time mirror mechanism allows also instantaneous remote metabolism: system gets positive energy by sending negative energy topological light rays/photons to some system able to receive them. If the receiving system is population inverted laser, a cascade like process generating positive energy photons propagating to the future and to the system which sent the negative energy photons. The cascade results because the probability of bosons to drop in ground state is proportional to the number of bosons already in ground state. This mechanism makes biological system extremely flexible since any part of it can get energy instantaneously if needed.

#### Instantaneous quantum remote sensing?

Ordinary remote sensing technology is limited by the finite velocity of light making it impossible to remote sense actively objects that are too faraway. Time mirror mechanism suggests a technology of active remote sensing based on time reflection at the studied object and thus involving no time lapse, and making possible remote sensing of arbitrarily distant, even astrophysical, objects due to the possibility of amplification in reflection and the fact that topological light rays are "outside" the space-time and the interaction with matter is very weak. The only additional condition is



the presence of the many-sheeted population reversal. This condition could be satisfied for living matter at least.

Dela-Warr camera [J33] might be based on this mechanism. Even more science-fictionally and a little bit of tongue in cheek, one can consider also the possibility of communicating with the civilizations of the geometric future by using population inverted lasers. Send to the geometric future classical  $k$ -bit signals ( $k$  harmonics of the fundamental) at  $p$ -adic frequencies  $f(n, k)$  to tell that we have discovered  $p$ -adic cognitive codes, and wait whether the population inverted lasers at these frequencies return to the ground state with an abnormally high rate! One can easily imagine simple codes for communication. For instance, for  $p$ -adic length scales corresponding to visible wave lengths the typical number of bits would be 163.

### Remote utilization of energy

In the technological context remote metabolism would translate to a remote utilization of energy stores making unnecessary the costly transport of the fuel. Only negative energy signal of critical intensity would be required to generate amplified positive energy signal from the geometric past providing the energy instantaneously and over long distances. Since many-sheeted lasers defined by space-time sheets of many-sheeted space-time are everywhere (energies correspond to zero point kinetic energies), the spaceship could get its energy almost in any environment which is sufficiently many-sheeted.

The need to carry large amounts of fuel and the limitations posed by the maximal classical signal velocity are the basic problems of the space technology. The technological variant of the remote metabolism might provide at least a solution to the fuel problem. The work with the Searl machine suggests that phase conjugate laser beams could also generate antigravity effects [K78].

### Sharing of mental images and telepathic communications

Time mirror mechanism allows also the system of geometric now to entangle with that of the geometric past. This means that the systems of geometric now and past share mental images. This could be the mechanism of episodal memory in which events of geometric past are re-experienced. The mechanism makes also possible telepathic sharing of mental images: for the system in future the experience represents memory (not necessarily personal) and for the system of past to precognition. It might be that the civilizations of remote geometric future have developed this mechanism to a refined technology allowing them to directly experience what the civilizations of geometric past and future experience. Encounters of UFOs and aliens could be this kind of remote contacts. They would be absolutely real encounters in the sense that the sensory perceptions are about real aliens but generated telepathically.

### Plasma oscillation patterns as holograms

The so called 4-wave interaction involves four laser beams: probe beam and its phase conjugate and two laser beams in opposite directions and interfering to a standing wave [K12]. In bio-systems probe beam and its phase conjugate would be responsible for remote metabolism providing the energy needed to build the hologram by time mirror mechanism. Standing wave in turn would define a simple hologram serving as a fundamental sensory representation from which more complex sensory representations are constructed. If the oppositely moving laser beams have slightly different frequencies, the standing wave pattern moves. Nerve pulse could basically result in this manner.

Plasma oscillations of ionic charge densities represent standing waves since the plasma oscillation frequency does not depend on the wavelength so that the standing pattern repeats periodically. The metabolic energy needed to build up plasma oscillation patterns would be obtained by time mirror mechanism using wave and its phase conjugate (probe beam and its phase conjugate).

This would be one reason for why ions are so crucial for living cell. All atomic nuclei are completely ionized  $Z^0$  ions and this would make possible further plasma oscillations. In fact, the  $Z^0$  plasma frequency of water corresponds to the fundamental metabolic energy currency .44 eV so that metabolism could be used to build  $Z^0$  holograms based on water molecules. Many-sheeted space-time predicts entire hierarchy of plasma frequencies coming as powers of 2.

### 8.3.4 Vision about the evolution of life

The notion of many-sheeted space-time could allow to understand many puzzles related to the pre-biotic evolution [I34, I44]. There are many constraints on the models for pre-biotic evolution. The models have also many difficulties [I22, I33].

#### Cognitive evolution proceeding from long to short scales is also present

General principles of TGD lead to an overview about how evolution must have proceeded. Usually the evolution of life is seen as an evolution proceeding from short to long length scales (atoms, molecules, cells,...). Also cognitive evolution must have occurred in parallel with the chemical evolution, and since p-adically small means large in real sense, cognitive growth must have proceeded from long length and time scales to short ones. Learning of a motor skill and carving a statue by starting from a rough sketch and adding gradually details are good examples of the process. Magnetic flux tubes structure must have developed gradually more and more intricate by the emergence of local structures by a process analogous to a construction of a fractal. The resulting magnetic flux tube structures have in turn served as templates for the formation of bio-matter.

The study of field equations leads to a classification for the phases of matter according to the dimension of  $CP_2$  projection. Magnetic field structures for which  $CP_2$  projections have dimensions  $D = 2$  and  $D = 3$  have interpretation as phases analogous to ferromagnetic phase and spin glass phase respectively and  $D = 2 \rightarrow 3$  phase transition would be presumably induced by the interaction of flux tube structures with bio-matter and lead to the extremely complex but organized phase identifiable as living matter.  $D = 4$  phase would in turn correspond to chaotic phase analogous to a demagnetized phase.

These ideas lead to a rather detailed vision about how the pre-biotic evolution might have proceeded.

#### 1. Standard vision about pre-biotic life is problematic

The prevailing mechanistic world view forces to conclude that life emerged accidentally in young Earth during a relatively short time period of about .3 billion years. On basis of extensive computer simulations, one can fairly say that a spontaneous generation of life in primordial ocean seems extremely implausible [I22].

TGD replaces materialistic view with a continual re-creation in which classical universe in 4-dimensional sense is replaced by a new one in each quantum jump. p-Adic length scale hypothesis allows to formulate the notion of evolution precisely as a generation of increasingly larger space-time sheets characterized by preferred p-adic primes meaning also a sequence of symmetry breakings. Macroscopic and even astrophysical quantum coherence becomes a key features of living matter. Theory is partially non-deterministic also in classical sense but the absolute minimization of Kähler action and self-organization lead to Darwinian selection of selected patterns.

#### 2. Did life develop in the womb of Mother Gaia?

A stable star and planet providing appropriate conditions such as temperature for liquid water is needed. The many-sheeted view about life widens dramatically the spectrum of possible environments for the pre-biotic evolution. In fact, the interior of the many-sheeted Earth could contain Mother Gaia's womb providing a shielded environment for the evolution of life instead of the rather harsh environment defined by the primordial atmosphere and ocean.

The womb would be located somewhere below the boundary at which  $k = 137$  atomic space-time sheets transform to very hot  $k = 131$  space-time sheets: this should occur when the thermal de Broglie wave length becomes equal to the p-adic length scale  $L(131)$ . The transition occurs above the crust-mantle boundary (1300 K). Below the 131 – 137 boundary, the temperature at  $k=137$  atomic space-time sheets diminishes and the range of temperatures could cover also room temperature. Mantle-core boundary (4000 K) is a good candidate for the surface at which the temperature at  $k = 137$  space-time sheets is near to the room temperature.

In a sharp contrast to the standard wisdom, something like a mirror image of the biosphere should exist at the other side of the mantle if one takes many-sheeted space-time seriously. The hot  $k = 131$  space-time sheets yield a thermal radiation with wave lengths containing ordinary metabolic energy currency about .5 eV. The dropping of ions O, C, N from the hot  $k = 131$  space-time sheets to larger space-time sheets generates light at visible frequencies replacing solar light

so that even intra-terrestrial counterpart of photosynthesis could develop. The dropping of oxygen atoms could make also possible development of oxygen based metabolism.

### 3. Was chemical evolution guided by magnetic body of Mother Gaia?

The notions of many-sheeted body, topological field quantization, and classical  $Z^0$  modify profoundly the views about chemical evolution.

1. Atoms like C, N, and O and smaller amounts of P and S giving rise to bio-monomers, and metals like Al, Fe, and Zn are the basic building blocks. The formation of various chemical bonds like hydrogen bonds, covalent bonds, and peptide bonds could involve many-sheeted physics in a nontrivial manner.
2. The formation of biological monomers (amino acids, nucleotides, fatty acids, sugars) is an essential element of life. Except for DNA nucleotides, basic monomers evolve in the circumstances simulating to what have been believed to be the primordial atmosphere. These bio-monomers are found even in the interstellar space and in galactic clouds so that the question is not whether the pre-biotic life can develop but whether our recent day materialistic science allows to understand how it develops. The standard wisdom about primordial atmosphere as a reducing environment (containing no oxygen) indeed leads to grave difficulties. Also the concentrations in the primordial ocean seem to be quite too low for the bio-monomers to be synthesized [I33]. Magnetic flux tube structure of the magnetosphere acting as a nervous system and a metabolic circuitry of the magnetic Mother Gaia could make possible controlled metabolism already during the pre-biotic period and allow to circumvent these difficulties.
3. The formation of the biological polymers such as proteins, nucleic acids, lipids, and carbohydrates occurs universally by dehydration. The problem is that in water environment polymers are un-stable against decay by hydration: it would seem that a metabolic energy feed is required already at this stage to guarantee non-equilibrium situation. The solution to the difficulties could be quantum control from the magnetic flux tubes of magnetosphere providing primordial metabolism with the same universal energy currencies as associated with the recent metabolism. Phosphate-sugar polymers form the backbone of nucleic acids and metabolism is based on ADP and ATP formed from adenine and phosphate ions. It has been already earlier found that the generation of ATP and its metabolic utilization involve the flow of protons between the atomic space-time sheets and some larger space-time sheets, say magnetic flux tube of Earth [K34]. It will be found that this mechanism is involved also with the dehydration leading to polymerization and phosphorylation. The reversal of this process also implies the un-stability of DNA in an ordinary aqueous environment.
4. The assembly of these macro-molecules into organized aggregates like chromosomes, microtubules and cell organelles could involve many-sheeted physics. Classical  $Z^0$  fields generated by nuclei, which are completely ionized  $Z^0$  ions, are screened by neutrinos but not locally since the size of neutrinos is much larger than the size of the nucleus. Classical  $Z^0$  fields, besides explaining chiral selection of bio-molecules, could be a central tool in the control of the molecular engineering since  $Z^0$  tidal forces allow to distinguish between nuclei with different A-Z/A ratios.
5. Also the emergence of catalysts, metabolism, and the membrane bound structures should be understood. Super-conductivity at magnetic flux tubes and its breakdown, as well as the possibility of negative energy MEs having phase conjugate laser waves as standard physics counterparts, are expected to be especially relevant for the catalytic action. Bound state quantum entanglement in macroscopic length scales is also an absolutely essential part of this mechanism. Intentional action realized in terms of negative energy MEs and appearing already at the molecular level, is expected to become an increasingly important aspect of catalytic action when the complexity of the structures increases. In TGD framework a primitive many-sheeted metabolism is present from the beginning and becomes only refined during evolution. Most importantly, metabolic currencies are constants of nature by the p-adic length scale hypothesis. Self-organization in many-sheeted space-time is expected to automatically lead to the generation of the gel phase as a possible predecessor of membrane

bounded structures as well as of membrane structures themselves containing liquid crystal water stabilizing also DNA nucleotides.

#### 4. *Emergence of genetic code*

The emergence of the genetic code has remained a mystery in various scenarios of pre-biotic evolution. The TGD inspired solution of the puzzle came from a rather unexpected (or should one say un-respected) direction. Chilbolton and Crabwood crop formations [H1, H2, H5, H7] led to the realization of the exact A-G symmetry and slightly broken T-C symmetry of the genetic code. These symmetries strongly suggest that the evolution of the triplet code occurred as a fusion of singlet and doublet codes. One ends up with a detailed model for how this happened by using some hints provided by Chilbolton crop formation [H1, H2] and the structure of tRNA molecule carrying in its fossilized parts detailed information about the evolution of the code. Nanno-bacteria [I30, I24] might correspond to some predecessor of the recent genetic code. Nanno-bacteria accompany mineral structures and actively manipulate them: this conforms with the view that mineral interfaces have been indeed important for the evolution of polymers.

Introns are the basic mystery of DNA. TGD predicts that language is a universal phenomenon. It appears already at prokaryotes and is based on genetic code realized as temporal field patterns and at level of eukaryotes introns define memetic code (code word has 126 bits) besides genetic code and define kind of higher level language. Memes represented as sequences of 21 DNA triplets and expressing themselves as field patterns associated with MEs would realized this higher level universal language.

#### **Plasmoids as primitive life forms?**

If the self-organization leading to the generation of life proceeds from magnetic body of to the biological body then simple many-sheeted topological quanta containing plasma, plasmoids, should be the simplest life forms. For instance, plasmoids could carry torus like magnetic flux configurations. The flux tubes of magnetic field can form extremely complex knotted and linked structures. This topology provides almost enormous representational capacity and one can wonder whether the opportunistic Nature could really have failed to notice this opportunity.

Perhaps the simplest plasmoids (even ball lightning!) might be regarded as the magnetic counterparts of the simplest monocellulars. Note that small plasmoids should be generated also when supra-currents in bio-matter leak out from the magnetic flux tubes. Neural circuits might be accompanied by plasmoids responsible for the self-organization of the ordinary matter around them.

The zero point kinetic energy liberated when particles drop from say atomic space-time sheets to the space-time sheets magnetic flux tubes, would define basic metabolic energy quanta for the plasmoid. Therefore metabolic energy quanta would be by p-adic length scale hypothesis universal and same everywhere in Universe. Thus metabolism would not be result of biochemical evolution but precede it. Plasma oscillation patterns at plasma-frequency are ideal hologram like sensory representations built using time mirror mechanism so that plasmoids could have primitive sensory systems.

##### 1. *Plasma sheet as a 'microchip'*

There is a fascinating finding about the 'memory chip' character of the organization of the ionic velocity distribution in the plasma sheet [F5] at the night side of the Earth's magnetosphere. The belief was that the distribution is a Maxwellian thermal distribution but a complex organization of the number of ions as a function of speed and direction relative to the direction of the local magnetic field has been detected [F5]. By coloring the bins representing small volumes of the velocity space, one finds that 3-dimensional features like 'eyes' and 'wings' appear! The proposed interpretation is that these features codes the history of ionic currents. One cannot exclude the possibility that these ionic currents could reflect even our sensory experiences. The prediction is that also other transition regions (in particular magneto-pause) should exhibit similar complex self-organization patterns.

##### 2. *Plasmoids in laboratory*

It seems that one of the most craziest predictions of TGD inspired theory of consciousness has been realized at laboratory. Quite recent report tells about plasmoids generated in a simple diode involving plasma generator creating plasma column between itself and the positively charged anode [I43]. The plasmoids are self-organizing structures able to evolve in a period of few microseconds. They possess many properties that life forms are expected to have. Plasmoids

1. grow from micrometer size up to cm size,
2. replicate by simply dividing into two pieces,
3. have an outer negatively charged surface separating the positively charged interior from the environment and obviously analogous to the cell membrane. Hence the plasmoid is analogous to a capacitor, and the exchange of matter with the environment could correspond to a dielectric breakdown essential for qualia in TGD based model of the sensory receptor,
4. possess a metabolic cycle involving the transfer of matter between the interior of the plasmoid and environment. This cycle is seen as a periodic generation of visible light at specific frequencies: the light balls are typically found to be red or yellow. The frequency of metabolic oscillations is at 25-45 kHz frequency range,
5. are able to communicate by generating electromagnetic radiation by inducing vibrations in the receiving plasmoid at the same frequency.

These findings give valuable hints concerning the more detailed modelling the "biology" of plasmoids. Plasmoids are in a key role in the TGD inspired model of pre-biotic evolution discussed in [K27]. For instance, one can ask whether the preferred colors might be interpreted in terms of quantized increments of zero point kinetic energies liberated when atoms or ions (such as C, N, and O) drop from the hot  $k = 131$  space-time sheets (temperature being of the order of the zero point kinetic energy) to larger space-time sheets.

### 3. Plasmoids and the emergence of dark $H_N$ -atoms

As already discussed briefly, the notion of dark  $N$ -atom leads to a new vision about hydrogen bond and water, and allows to identify a fundamental mechanism of catalysis. For instance,  $H_N$  atom at  $k = 1$  level of dark matter hierarchy can be regarded as a space-time sheet folded  $r$  times in radial direction. Single electron energies are in the lowest order approximation same as for ordinary hydrogen atom and the sizes of  $H_N$ - and  $H$ -atoms are also same. What is new that the number of electrons can range from  $N = 1$  to  $N = r$ . This means that  $H_N$ -atoms define ideal letters for the names of molecules obtained by replacing ordinary hydrogen atoms capable of forming hydrogen bonds with  $H_N$ -atoms. The fusion of  $H_N$ - and  $H_{N_c}$ -atom ( $N_c = r - N$ ) is strongly favored since it gives rise to  $r$ -atom expected to be especially stable as a full electron shell.

The identification of the hydrogen atoms of hydrogen bonds as  $H_r$ -atoms leads to a general vision about how symbolic representations appear at the molecular level and how the extreme selectivity of bio-catalytic is due to the enhanced probability molecules with name and conjugate name to fuse to hydrogen bonded reaction complex and spitting out one proton dropping to a larger space-time sheet and liberating metabolic energy quantum in this process kicking the reaction complex over the potential wall to the final state. Also the exceptional role of water in the evolution of life can be understood.

How the first  $H_N$  atoms did emerge becomes the basic question about pre-biotic evolution. A plasma phase containing free electrons seems to be a necessary prerequisite if one takes seriously the hypothesis that the increase of Planck constant as a phase transition taking place as gauge interactions become so strong that the perturbative treatment fails (color confinement of quarks is good example of this phenomenon).

This supports the view about plasmoids as predecessors of molecular life forms, and also encourages to take more seriously the crazy sounding idea that hot temperatures, say those prevailing in planetary interiors or even solar photosphere, are a necessary prerequisite for the emergence of plasmoids and possible  $N$ -molecular variants of life [K27, K20].

### Dark matter hierarchy and evolution

Dark matter hierarchy leads to an amazingly concrete picture about evolutionary hierarchy allowing to identify the counterparts for concepts like mineral, plant, and animal kingdom that we learned during schooldays and ceased to take seriously as students of theoretical physics as we learned that other sciences are just taxonomy. Even more, a view about what distinguishes between prokaryotes, eukaryotes, animal cells, neurons, EEG, and even about what makes cultural evolution, becomes possible.

Mersenne hypothesis [K22] predicts a hierarchy of Planck constants  $\hbar = \hbar_0$ ,  $r = 2^{k_d}$ , with values of  $k_d$  fixed by the condition that Mersenne primes and their Gaussian counterparts define p-adic length scales to which one can assign fractally scaled up variant of weak interactions and perhaps also color interactions. The condition that dark variants of these physics include the Mersenne length scales poses strong conditions on the values of  $k_d$  and leads to a detailed view about biological evolution.

Ordinary matter corresponds to  $k_d = 0$  and ordinary value of  $\hbar$  and higher levels correspond to scaled up values of  $\hbar$ . This means scaling up of various quantum length scales and also the sizes of space-time sheets by  $r$ . It seems that magnetic flux quanta are the primary structures forming hierarchy of this kind and large  $\hbar$  means that cyclotron energy scales expressible as  $E = \hbar e B / m \propto r$  so that an arbitrarily weak magnetic field strength can in principle correspond to a cyclotron energy above thermal threshold at room temperature.

The appearance of space-time sheets zoomed up in size by a power of  $r$  means the emergence of new levels of structure and it is natural to identify big leaps in evolution in terms of scaling of  $\hbar$  by  $r$  and emergence of new large magnetic flux sheets satisfying magnetic flux quantization condition with the unit of flux scaled up by  $r$ . This leap is quantum leap but in different sense as thought usually. The emergence of higher dark matter levels would basically mean the integration of existing structures to larger structures. A good metaphor are text lines at the pages of book formed by magnetic flux sheets whose width is scaled up by  $r$  as the new level of dark matter hierarchy emerges.

This conceptual framework gives rather strong guidelines for the identification of the levels of evolutionary hierarchy in terms of dark matter hierarchy. The outcome is a detailed vision about big evolutionary leaps discussed in [K40] in detail.

#### 8.3.5 Could simple life forms be induced by intentional action?

Since life would involve self-organization of magnetic flux tube patterns, one can consider the possibility that intentional actions could induce this self-organization and in well-defined sense give the spark of life to the dead matter. Obviously, the highly advanced civilizations of geometric future might have developed a kind of spark-of-life technology and using time mirror mechanism they could induce self-organization inducing life in remote geometric past. Perhaps we are doing this all the time for our brains of the geometric past when we remember.

There is some support for this wild speculation. William Tiller in Stanford University has carried out impressive experimental work with what he calls intention imprinted electronic devices (IIED), and his results challenge that standard assumption that the intentions of experimenter do not affect the experimental apparatus [J28, J29, J30]. The simplest explanation for the findings is that intentional action induces magnetic self-organization of IIED and of the target material used in experiments. For instance, purified water develops pH-, temperature- and conductivity oscillations and its pH becomes sensitive to external magnetic fields.

#### Experimental arrangement

The goal was to try to imprint a specific intention into a simple, low tech electronic device so as to influence the companion, specific, well-designed, target experiment. The intentional imprinting was attempted in a meditative state. The intentionally imprinted device, IIED, was sent to a laboratory located at distance of about 1500 miles where colleagues had set up the experiment. The device was placed about 6 inches from a continuously running and computer-monitored target experiment and switched on (total electrical power rate was less than 1 microwatt). Over a time period of about 1-4 months the recorded results from the target experiment changed in the directions of the specific intention and the change eventually reached the selected magnitude of the specific intention. Also

an identical, but not intention imprinted device was used and the results were compared in order to achieve more objective measurements about the effects of human consciousness on electric devices.

The targets used were purified water, some bio-molecules, and larvae of flies. These targets were either unshielded or shielded from radiation. For the latter purpose they were closed inside a grounded Faraday cage (FC), which screened rather effectively the radiation coming at microwave frequencies whereas for ultra low frequency (ULF) fields the screening is virtually absent (skin depth behaves as  $1/\sqrt{\pi\sigma f}$  at low frequencies and  $f = 2\pi\sigma$  (in units  $\hbar = c = 1$ ) defines kind of critical frequency above which screening occurs effectively). The targets could be affected by control device (CD) or by identical IIED generating microwave radiation. Radiation was generated either at single frequency (7.3 MHz) or at three frequencies (5.0, 8.0 and 9.3 MHz) [J32] .

In the case of purified water the spatial distributions of physical parameters like pH, temperature, and conductivity were measured as a function time. In the case of bio-molecules the possible effect on thermodynamical activity, which measures the thermodynamical energy of single molecule, was measured. In the case of fly larvae the possible effect on the larval development time was studied. The results from various arrangements were compared with control targets (no FC, no CD, no IIED).

### Experimental findings

The basic experimental results were two-fold. First of all intended effects were achieved. Secondly, the "conditioning" of the laboratory resulted as an unexpected effect and continued even after the removal of the target and IIED.

#### 1. *Effects of the intentional action*

1. IIED imprinted by intention to increase/decrease the pH of water gradually induced a shift in the pH of purified water to the intended value, increased the in vitro thermodynamic activity of bio-molecules, and a reduction of larval development time.
2. For bio-molecules and larvae four simultaneous side-by-side treatments were tested):
  - (a) an unshielded sample,
  - (b) a shielded sample,
  - (c) a shielded sample with an "on" control device,
  - (d) a shielded sample with an "on" IIED.

Just the shielding of em radiation affected the thermodynamic activity of the bio-molecules, and just adding less than about 1 microwatt of microwave radiation via control device reduced the thermodynamical activity and lengthened the developmental time. Thus the microwave radiation acted as a stressor having entropic effect. When the control device was replaced with IIED, the degradation caused by microwave radiation was overcome.

#### 2. *"Conditioning" of the laboratory*

Quite unexpected phenomena arose from a repeated conduct of IIED in a given laboratory space. By simply continuing to use IIED in the laboratory space, it became "conditioned in some very fundamental way". Three signatures heralded the onset of the "conditioning" process.

1. Oscillations of air and water temperature, and of pH and electrical conductivity of water with large amplitudes with the periods of oscillations in 10-100 minute range developed. The amplitudes of pH- and temperature oscillations was  $\sim \Delta pH = .1$  pH-unit and  $\Delta T \sim 1 - 3$  K units respectively. Even more remarkably, the oscillations were sustained in the locale even after the removal of the IIED suggesting kind of phantom effect analogous to phantom DNA effect. Oscillation amplitude had peaks at the harmonics of fundamental frequency  $f_i = 1/T_i$ ,  $T_i = 36.6$  minutes with three lowest harmonics being very clearly visible [J30] . Also  $T_i = 51.2$  minutes appears as fundamental period in some experiments. The ratio of these periods is 1.4 and rather near to  $\sqrt{2} = 1.41$ , which might relate to p-adic length scale hypothesis.

2. When an pH-increasing IIED with intention to increase pH by one unit was turned on in an almost unconditioned space located several hundred feet away from a strongly conditioned space, a well-defined pattern of pH-oscillations in an unconditioned space emerged. This pattern was accompanied by a highly correlated pattern of oscillations in strongly conditioned space. This kind of highly correlated oscillations were not observed in several unconditioned spaces also located several hundred feet away.
3. The targets were subject to the action of a vertically aligned magnetic field in the range of  $10^{-2} - 5 \times 10^{-2}$  Tesla, such that the direction of the field could be reversed. In an unconditioned space the change of the direction of the magnetic field did not affect the pH. In the strongly conditioned space the effect on pH was different for the opposite directions of the applied field and the difference in pH values was about .6 units. One can say, that the target had become sensitive to the effects of external magnetic fields.

### Explanation of the pH oscillations in terms of the general model of intentional action

The findings described above support the notion of magnetic body as mediator of the intentional action, and provide a connection with the general TGD based vision about pre-biotic evolution. The following general model for the effects suggests itself.

#### 1. *Intentional action induces magnetic self-organization of the control device and target*

The magnetic body of IIED becomes a part of the intentional agent. Also the magnetic body of the target (purified water, etc...) partially fuses with that of IIED. Even more, the general model for the pre-biotic evolution [K27] suggests that the intentional action mediated via the IIED induced a self-organization of a p-adic hierarchy of topological field quanta of magnetic field in the target system. This kind of hierarchy is associated also with DNA in the TGD based model for the effects of laser radiation on DNA observed by Gariaev [I28]. The generation of magnetic structures in shorter length scales is what one expects the intentional action to generate since intentional "growth" proceeds quite generally from long to short length and time scales.

The simplest candidate for the time scale of oscillations varying in 10-100 minute range is as the time scale associated with the cyclotron frequency of magnetic field quanta responsible for the intentional action. The cyclotron period of proton lies in 10-100 minute range for a magnetic field strength varying in the range of 27.8-278 pT. For  $T_l = 36.6$  minute period the field strength would be 75.9 pT. The corresponding magnetic length is 4 mm and near to  $L(188) = 3.7$  mm. The harmonics of the fundamental  $f_l$  could correspond to the quantized values of the magnetic flux coming as integer multiples of the basic flux with the strength of magnetic field quantized to integer multiples. Similar quantization of the  $Z^0$  magnetic field strength is assumed in TGD based model of hearing [K56].

Cyclotron oscillations in the magnetic field could induce by some mechanism a periodic flow of protons between the magnetic flux tubes and the atomic space-time sheets of water and in this manner affect pH. pH-fluctuations would in turn induce temperature and conductivity fluctuations as side effects. Both  $T_l = 51.2$  min and  $T_l = 36.6$  min appear and have ratio very near to  $L(k+1)/L(k) = \sqrt{2}$ . If this finding is taken at face value, the magnetic flux quanta must be magnetic sheets for which magnetic flux scales as the inverse of the thickness  $d = L(k)$  of the flux sheet having constant size in the second transversal dimension.

#### 2. *Scaling law of homeopathy and frequencies of pH-oscillations and microwaves*

The experiment involves two frequencies: the ULF frequencies associated with the pH-oscillations and the frequencies associated with the microwaves generated by the control device. Since intentional action compensates for the entropic effect of microwaves, these frequencies must relate to each other and generalized scaling law is an excellent candidate in this respect.

The TGD based model explains and generalizes the scaling law of homeopathy, which states that low and high frequencies having ratio  $f_h/f_l = 2 \times 10^{11}$  accompany each other. Cyclotron oscillations with frequency  $f_l$  would result when charged particles drop from smaller space-time sheets and liberate the increment of zero point kinetic energy as a radiation with frequency  $f_h$ . Also the reverse of this process could occur with generation of negative energy photons at frequencies  $f_h$  and  $f_l$ . The emission of two photons is needed to guarantee momentum conservation since the momenta of charged particles are so small as compared to photon momenta.



The generalized scaling law predicts

$$f_h/f_l = \Delta E_0/E_c(k_2) ,$$

where  $\Delta E_0 = E_0(k_1) - E_0(k_2)$  is the zero point kinetic energy increment when a charged particle drops from the space-time sheet labelled by  $k_1$  to the sheet labelled by  $k_2$ .  $E_c(k_2)$  denotes cyclotron frequency at the magnetic flux tube labelled by  $k_2$ .

The factor  $f_h/f_l$  varies but does not depend on the mass of the charged particle and by the quantization of the magnetic flux are apart from a numerical factor proportional to the ratio  $p_2/p_1 = 2^{k_2-k_1}$  defined by the p-adic primes  $p \simeq 2^k$  for the two space-time sheets in question. The scaling law of homeopathy in its basic form and p-adic length scale hypothesis suggest that  $f_h/f_l$  is related by a power of two to  $f_h/f_l = 2 \times 10^{11} \sim (200/256) \times 2^{38}$  so that one has

$$f_h/f_l = 2 \times 10^{11} = (200/256) \times 2^n ,$$

where the integer  $n$  varies.

The generalized scaling law suggests that the frequency of pH oscillations corresponds to  $f_l$ . The frequencies of microwaves would correspond to  $f_h$  identifiable as the zero point kinetic energy of proton liberated when it drops from space-time sheet generated by the intentionally induced magnetic self-organization.

### 3. The mechanism of intentional action

The control device generates microwaves, and the intentional action should compensate the effect of the control device. The model of the intentional action based on the time mirror mechanism supports the view that negative energy MEs and photons are involved. Phase conjugation means essentially time reversal, and it could compensate the entropic effect of the ordinary microwaves generated by IIED and acting as a stressor in case of fly larvae. This also conforms with the fact that phase conjugate microwaves and ULF waves can penetrate the Faraday cage.

The microwave radiation at frequencies  $f_h$  could induce a flow of protons between  $k = 167$  space-time sheets and larger space-time sheets by providing the needed zero point kinetic energy to kick protons to  $k = 167$  space-time sheet. Negative energy (phase conjugate) microwave photons would induce the reverse process. By the basic mechanism of induced emission (now induced dropping) this in turn could induce the flow of protons from atomic space-time sheets to smaller space-time sheets as a kind of domino effect, and lead to a new flow equilibrium would result with different pH. The pre-requisite of this mechanism is that the hierarchy of the magnetic flux tubes characterizing also DNA is present in the target. The IIED affected by the intentional action would give rise to this magnetic hierarchy unless it already exists. IIED would play a role similar to an object received by the person to be healed from the healer (or vice versa) in remote healing.

A more detailed space-time description for what happens might be as follows.

1. ULF and microwave fields are coherently superposed inside MEs (incoherence would mean microwave MEs inside ULF MEs) so that the corresponding transversal magnetic and electric fields are precisely parallel by the highly non-linear properties of MEs. ULF frequencies correspond naturally to harmonics of cyclotron frequency because of the strong coupling to cyclotron phase transitions of the Cooper pair Bose-Einstein condensate.
2. MEs serve as temporary bridges connecting the boundaries of  $k = 169$  and  $k = 188$  space-time sheets and the oscillating electric field of ME is orthogonal to the boundaries. By quantum classical correspondence the microwave frequencies associated with ME as well as the voltage along the bridge correspond to integer multiples for the energy of a microwave photon. The same mechanism based on  $Z^0$  MEs underlies the TGD based model of nerve pulse.
3. The superposed ULF and microwave frequency electric fields inside ME induce a periodic flow of the protonic Cooper pairs forth and back between the super-conducting flux tubes of the Earth's magnetic field ( $k = 169$ ) and magnetic flux tubes of the field  $B_I$  ( $k = 188$ ). Microwave part induces a rapidly oscillating force superposed to the slowly varying ULF part of the force. The oscillatory flow of protons from atomic space-time sheets to larger space-time sheets affects the proton density at atomic space-time sheets causing pH oscillations.

4. Do the three peak frequencies for  $pH$ -oscillations correspond directly to three microwave frequencies by scaling law?

Scaling law would suggest that the three peak frequencies coming as harmonics of  $f = 1/T_l$ ,  $T_l = 51.2$  min, correspond to three frequencies  $f_l$  identifiable as cyclotron frequencies corresponding to the quantized values  $n = 1, 2, 3$  for the magnetic flux. The frequencies produced by control device producing microwaves in 1-10 MHz range are non-trivial [J29, J30] and the first bet is that the frequencies given by the generalized scaling law must be in this range to compensate the entropic effects. The generalized scaling law  $f_n/f_l = (200/256) \times 2^n$  with  $n = 33$  gives the frequencies  $f_n = 3.1$  MHz and its two harmonics 6.2 MHz and 9.3 MHz as counterparts of  $f_l$  and its harmonics. The frequencies produced by the control device are 5.0, 8.0 and 9.3 MHz and not harmonics of each other. Note however that the highest frequency corresponds exactly to the third harmonic of  $f_l$ .

Rather remarkably,  $f_n = 3.1$  MHz corresponds to the zero point kinetic energy of a protonic Cooper pair at  $k = 169$  space-time sheet associated with the magnetic flux tubes of the Earth's magnetic field. Thus protonic Cooper pairs could drop from the super-conducting flux tubes of the Earth's magnetic field to the magnetic flux tubes of  $\sim 76$  pT magnetic field having  $k = 188$ . This in turn would generate a cascade like dropping of protons from the atomic space-time sheet so that  $pH$  is changed.

5. Correlation between  $pH$  and temperature oscillations and protonic zero point kinetic energy

In the case of water at temperature  $T = 300$  K the amplitudes of oscillations are  $\Delta T = 3$  K and  $\Delta pH \simeq .1$ . If the density of protons satisfies  $n = n_0 \exp(-\Delta E/T)$ , where  $\Delta E$  is most naturally the zero point kinetic energy .4 – .5 eV of protons at the atomic space-time sheet, one has

$$\Delta pH = \frac{\Delta E}{T} \times \frac{\Delta T}{T} .$$

$\Delta pH = .1$  would require  $\Delta E \simeq .3$  eV, which is quite near .4 – .5 eV.

The fact that the exponential  $\exp(-\Delta E/T)$  happens to be near to the number  $n/n_{H_2O} = 10^{-pH}$ , gives further support for the idea that the zero point kinetic energy at  $k = 137$  space-time sheet determines  $pH$ , or more generally, that the densities of various ions are determined by many-sheeted chemistry and by zero point kinetic energies. If this interpretation is correct,  $n(137)$  can be identified as the net density of protons including also protons bound to hydrogen atoms. The net density of protons at a given space-time sheet involves a degeneracy of states factor  $g(k)$  so that one would have

$$n(137) = \frac{g(137)}{g(169)} \times n(169) ,$$

where  $k = 169$  refers to the super-conducting flux tubes of the Earth's magnetic field. p-Adic fractality and p-adic length scale hypothesis imply that  $g(k)$  scales as  $1/L^3(k)$ . This gives  $g(169)/g(137) \sim (L(137)/L(169))^3 = 2^{-48} \simeq 4 \times 10^{-15}$ .

6. Sensitivity to the external magnetic field

The effect of the  $pH$  values depends on the direction of the external magnetic field  $B_{ext}$ . This could be understood if  $B_{ext}$  interferes with the magnetic field at some level of magnetic hierarchy induced by the magnetic fields in .1 nT range which mediate the intentional action.  $pH$  is changed if the change of the magnetic field at these space-time sheets in the cellular length scale range affects the flow of protons between atomic space-time sheets and larger space-time sheets when .1 nT flux tubes with thickness around 100  $\mu m$  are present. This is expected to be the case if the thickness of the flux tubes is affected by the external magnetic field. The flux tubes in a given p-adic length scale could even disappear as a result of destructive or constructive interference.

Concerning the detailed model there are two options.

i) If the magnetic field consists of flux sheets so that one has  $B(k) \propto 1/L(k) \propto 2^{-k/2}$ . In this case the external field strength corresponds to p-adic length scale  $L(k)$  related to the length scale  $L(169) \simeq 5 \mu m$  by a scaling of  $.5 \times 10^{-2} - 10^{-3}$  the length scale varies between  $L(149) = .5$  nm (thickness of the lipid layer of cell membrane) and 25 nm. This option is supported at the level of DNA magnetic hierarchy by the findings of Gariaev about effects of laser light on DNA, and also by

the fact that the ratio of  $T_l = 51.2$  min and  $T_k = 36.6$  min is very near to  $\sqrt{2}$ . This situation would result if the flux quanta at various p-adic length scales are quite generally obtained by scaling the flux tubes of the Earth's magnetic field in one direction by keeping the flux as constant.

ii) If the magnetic field consists of flux tubes ( $B(k) \propto 1/L^2(k) \propto 2^{-k}$ )  $L(k)$  is related to  $L(169)$  by a scaling by a factor  $.1 - .03$  so that it is in the range  $1.6 - .5 \mu\text{m}$ .

### 7. Phantom effect

A further strange finding is that the removal of both IIED and target does not eliminate the temperature oscillations of the air although their amplitude is reduced by a factor of about ten. The phantom effect can be understood if the magnetic flux tubes associated with  $k = 188$  magnetic field are present also in the air volume, and are not affected by the removal of IIED and target, so that the oscillatory flow of protons between  $k = 169$  and  $k = 188$  space-time sheets with cyclotron frequency continues and induces the oscillation of the proton density of air.

### The effects caused by the quartz crystal

In some experiments the removal of the target and IIED was followed by the addition of quartz crystal [J32]. The quartz crystal was made of natural quartz (in order to avoid undesired intentional imprinting!) and had height  $h = 15.24$  cm and minimum diameter  $d = h/2 = 7.62$  cm. The crystal was asymmetric in the vertical direction having apex pointing upwards.

The findings were following.

1. When the crystal was in a vertical direction, its presence sharpened the existing spatial phantom profile for temperature oscillations of air and somewhat amplified it.
2. When the crystal was turned to a horizontal direction, its presence immediately increased the temporal frequency of T-oscillations by a factor slightly larger than two. The spatial profile became first almost flat and the amplitude weakened.

The interpretation of the stimulates several ideas and questions.

1. *Does the spatial profile of T-oscillations correspond to a standing wave resulting as an interference pattern of microwaves?*

The spatial profile for the temperature oscillations is measured using spatial resolution  $D = h = 15.24$  cm, where  $h$  is the height of the quartz crystal. The profile is quasi-periodic with a period of  $\lambda = 2D = 2h$ . Of course, experiments with a better spatial resolution would be required to deduce reliably the profile but the measurements are consistent with a spatial oscillation having period  $\lambda = 2D = 2h$ . This kind of profile could result as an interference of two classical microwave beams propagating in two opposite directions and generating a standing wave with wave length  $2h$ . This kind of interference pattern is involved with the four-wave interaction producing phase conjugate waves: the interfering waves correspond to the reference beam and a beam opposite to it. The two additional beams correspond to beam and its phase conjugate, either of them generating the other one.

2. *Does the quartz crystal act as an amplifier?*

The orientation of the crystal is obviously important. This encourages to think that the incoming signal enters from a vertical direction and is amplified by the quartz crystal so that the vertical dimension determines the resonantly amplified wave lengths. Perhaps magnetic flux tubes of  $B_I$  and the Earth's magnetic field  $B_E$  are in this direction. It could be that the light-like vacuum current of ME generates positive or negative energy coherent photons with an intensity distribution having maximum in the directions orthogonal to MEs and that the presence of the quartz crystal amplifies the vacuum current inside ME. Alternatively, it could be enough that quartz crystal amplifies the the classical fields associated with MEs.

The height  $h$  of the quartz crystal is one half of the microwave wavelength. Hence it could act like an absorbing or emitting half wave antenna. The fundamental frequencies associated with the microwaves would correspond to  $f_1 = c/2h \simeq 1$  GHz for the vertical crystal and  $f_2 = c/2d = 2f_1 \simeq 2$  GHz for the horizontal crystal. For the vertical crystal  $\lambda_1 = 2h = 2D = 30.48$  cm would be the wavelength of the spatial profile which conforms with observations. For the horizontal crystal

period would be  $\lambda_2 = 2d = 15.4$  cm. The observed spatial profile immediately after the turning of the quartz crystal to horizontal position is flat in consistency with this prediction. It should be easy to check out whether the oscillatory pattern is present by improving the resolution.

*3. Are population inverted many-sheeted masers involved?*

The frequencies  $f_1$  resp.  $f_2 = 2f_1$  are rather near to the zero point kinetic energies of a protonic Cooper pair for  $k = 153$  resp.  $k = 152$ . In the case of electronic Cooper pairs one has  $k = 164$  and  $163$  (the ratio of proton and electron masses is near to a power of 2:  $m_p/m_e \simeq 2^{11}$ ). Perhaps many-sheeted population inverted micro wave lasers are involved and time mirror mechanism induces dropping of protons to large space-time sheets or the reverse process.  $k = 152$  and  $k = 153$  correspond to length scales  $\sqrt{2} \times L(151)$  and  $2 \times L(151)$ , where  $L(151) = 10$  nm corresponds to the thickness of the cell membrane. The four-wave interaction suggested by the interpretation of the spatial profile would presumably involve many-sheeted laser mechanism at the microscopic level.

*4. Scaling law of homeopathy is satisfied*

The approximate doubling of the ULF frequency of T-oscillations when the quartz crystal is turned to a horizontal position is consistent with the generalized scaling law of homeopathy. The ratio  $f_h/f_l$  of frequencies of microwave and ULF oscillations occurring at 51.2 min period is  $3.1 \times 10^{12}$  for  $f_h = f_1$  and  $6.2 \times 10^{12}$  for  $f_h = f_2$ . In a good approximation this ratio differs by a factor  $2^4$  resp.  $2^5$  from  $f_h/f_l = 2 \times 10^{11}$ .

These findings support the scaling law of homeopathy, time mirror mechanism as a microscopic part of the four-wave interaction utilizing many-sheeted population inverted lasers, and quartz crystal as an amplifier of intentional action. Much remains however poorly understood. In particular, the question how the phenomenological description of the four-wave interaction and time mirror mechanism could be integrated to a more comprehensive theory, remains open

## 8.4 Great vision about biological evolution and evolution of brain

The following great vision about evolution and is not perhaps strictly about hierarchy of EEGs. The hierarchy of dark matter and EEGs however leads to this vision naturally. The first part of vision relates to biological evolution. Second part is about the evolution of brain. Here the key thread is evolution of two kinds of intelligences, the ordinary fast intelligence evolving via the emergence of fast computation type activities and emotional slow intelligence developing via the emergence of higher levels of dark matter hierarchy. The latter intelligence is what distinguishes us from animals.

### 8.4.1 Basic assumptions

The great vision about evolution and brain relies on two several new notions and ideas.

1. Life as something in the intersection of real and p-adic worlds making possible negentropic entanglement- both space-like and time-like. This makes possible to understand what conscious intelligence is and NMP reduces evolution to a generation of negentropic entanglement (see fig. <http://www.tgdtheory.fi/appfigures/cat.jpg> or fig. 21 in the appendix of this book). DNA as topological quantum computer hypothesis [K25] finds also a justification.
2. The notion of many-sheeted space-time (see fig. <http://www.tgdtheory.fi/appfigures/manysheeted.jpg> or fig. 9 in the appendix of this book) suggesting a universal hierarchy of metabolic energy quanta, and the notion of magnetic body.
3. Communication and control based on Josephson radiation and cyclotron transitions crucial for understanding bio-photons and EEG and its fractal generalization as a key element of bio-communications.
4. Zero energy ontology and the closely related notion of causal diamond (CD) assigning a hierarchy of macroscopic time scales to elementary particles coming as octaves of the basic

time scale and justifying p-adic length scale hypothesis. Zero energy energy ontology also justifies the vision about memory and intentional action and the idea that motor action can be seen as time reversal of sensory perception.

5. The hierarchy of Planck constants and the identification of the fundamental evolutionary step as an increase of Planck constant. Evolutionary steps mean migration to the pages of the Big Book labeled by larger values of Planck constant and living system can be regarded as a collection of pages of the Big Book such that a transfer of matter and energy between the pages is taking place all the time. The change of the Planck constant implies either reduction or increase of the quantum scales-this leads to a model for biocatalysis and a model of cognitive representations as scaled down or scaled up "stories" mimicking the real time evolution.
6. A resonant like interaction between hierarchy of Planck constants and p-adic length scale hierarchy favoring the values of Planck constant proportional to powers of two, and idea that weak and color interactions are especially important in the length scales which correspond to Mersenne primes and Gaussian Mersennes. The simplest option is that weak bosons have their standard masses but appear as massless below their Compton length which scales up like  $\hbar$  and preferred p-adic length scales correspond to Mersenne primes. Also copies of weak bosons and gluons with ordinary value of Planck constant and reduced mass scale can (and will) be considered.

### How to identify the preferred values of Planck constant?

The basic problem is to identify the preferred values of Planck constant and here one can only make theoretical experimentation and all what follows must be taken in this spirit. One can consider assumptions which become increasingly stronger.

1. If only singular coverings of CD and  $CP_2$  are possible Planck constant is a product of integers. Algebraic simplicity of algebraic extensions of rationals favors ruler and compass integers (Appendix).
2. A resonant interaction between the dark length scales and p-adic length scales with ordinary value of Planck constant favors Planck constants coming as powers of two.
3. An even stronger assumption would be that p-adic length scales coming as Mersennes and Gaussian Mersennes are especially interesting.
  - (a) If weak bosons can appear with the ordinary value of Planck constant only in the p-adic length scale  $k = 89$ , one obtains the condition

$$k_d = k - 89 \quad , \quad k \in \{89, 107, 113, 127, 151, 157, 163, 167\} \quad (8.4.1)$$

for the values of  $r = 2^{k_d}$  allowing dark weak bosons in p-adic length scales assignable to Mersennes. These values of  $k_d$  assign to electrons and quarks dark p-adic length scales  $L(k_{eff}) = \sqrt{r}L(k)$ ,  $r \equiv \hbar/\hbar_0 = 2^{k_d}$ . The scales could correspond to size scales of basic units of living systems.

- (b) If weak bosons and possibly also gluons with ordinary value of Planck constant are possible in all p-adic length scales  $L(k)$ ,  $k \in \{89, 107, 113, 127, 151, 157, 163, 167\}$ , one obtains much richer structure. This hierarchy defines defines secondary dark matter hierarchies from the condition that the scaling the p-adic length scale  $L(k_1)$  in this set by  $\sqrt{r}$ ,  $r \equiv \hbar/\hbar_0 = 2^{k_d}$ , gives a p-adic length scale equal to another p-adic length scale  $L(k_2)$  in this set. This requires  $k_d + k_1 = k_2$  so that the values

$$k_d = k_2 - k_1 \quad (8.4.2)$$

are favored for the scaling of  $\hbar$ . In this case the hierarchy of dark scales assignable to quarks and leptons is much richer. The tables below demonstrate that electron appears

as its dark variant for all Mersennes and also in atomic length scales  $k = 137, 139$  so that this option puts electron in a completely unique position.

4. Also other scales are possible. For instance,  $r = 2^{47}$  required by 5 Hz Josephson frequency gives dark weak scale which corresponds  $k = 136$  as a p-adic scale. The stages of sleep can be understood in terms of scaling of  $\hbar$  by factor 2 and 4 so that also the atomic length scale  $k = 137$  and the scale  $k = 138$  are involved.

Since the experimental input is rather meager, one is forced to do theoretical experimentation with various hypothesis. The quantitative experimental tests are rather primitive but basically quantal.

1. The time scales assignable to CDs of leptons and quarks and their scaled up counterparts for the preferred values of Planck constant should define biologically important time scales. One might even speak about evolutionary level of electron. These time scales could define fundamental biorhythms and also time scales of long term memory and planned action.
2. Josephson frequencies and cyclotron frequencies scaling like  $1/\hbar$  (if magnetic field scales down like  $1/\hbar$ ) charactering biologically important ions and elementary particles. In accordance with the quantum criticality of living matter it is assumed that cell membrane corresponds to almost vacuum extremal so that classical  $Z^0$  force is an essential element of the model. Also these frequencies should define fundamental bio-rhythms and characterize the evolutionary level of cell. Experimentally of special importance are the cyclotron frequencies assignable to  $Ca^{++}$  ions.
3. The amplitude windows for electric field scaling like  $\hbar$  for a particular cyclotron frequency define a basic prediction.

**Tables about predicted time and length scales**

The following tables summarize various predictions for time scales and length scales. They correspond to the most general assumption that exotic bosons with the ordinary value of Planck constant are possible in all length scales associated with Mersennes and Gaussian Mersennes.

$k_d$	$p_1$	$p_2$		$k_d$	$p_1$	$p_2$
4	163	167		38	<b>89</b>	127
6	107	113		38	113	151
6	151	157		40	127	167
6	157	163		44	107	151
10	157	167		44	113	157
12	151	163		50	107	157
14	113	127		50	113	163
16	151	167		54	113	167
18	<b>89</b>	107		56	107	163
20	107	127		60	107	167
24	<b>89</b>	113		62	<b>89</b>	151
24	127	151		68	<b>89</b>	157
30	127	157		74	<b>89</b>	163
36	127	163		78	<b>89</b>	167

Table 5. The integers  $k_d$  characterizing the preferred values of  $r = \hbar/\hbar_0 = 2^{k_d}$  identified from the condition that the dark variant of p-adic length scale  $L(p_1)$  corresponding to some ordinary p-adic length scale defined by Mersenne prime  $M_p$  or Gaussian Mersenne  $M_{G,p}$ ,  $p \in \{89, 107, 113, 127, 151, 157, 163, 167\}$  corresponds to similar p-adic length scale  $L(p_2)$ . If one assumes that weak bosons can appear with ordinary value of Planck constant only in the p-adic length scale  $k = 89$ , only the rows with  $p_1 = 89$  of the table are possible: in these cases  $p_1$

is in boldface and the row has double underline. The corresponding values of  $k_d$  are in the set  $\{18, 24, 38, 62, 68, 74, 78\}$ .

Note that the table above include only the dark length scales associated with  $k = 89$  gauge bosons.

$Z, W$	d	u	e	$k_d$
89	120	124	127	<b>0</b>
93	124	127	131	4
95	126	129	133	6
99	130	133	137	10
101	132	135	139	12
103	134	137	141	14
105	136	139	143	16
107	138	141	145	<b>18</b>
109	140	143	147	20
113	144	147	151	<b>24</b>
119	150	153	157	30
125	156	159	163	36
127	158	161	165	<b>38</b>
129	160	163	167	40
133	164	167	171	44
139	170	173	177	50
143	174	177	181	54
145	176	179	183	56
149	180	183	187	60
151	182	185	189	<b>62</b>
157	188	191	195	<b>68</b>
163	194	197	201	<b>74</b>
167	198	201	205	<b>78</b>

Table 6. The dark p-adic length scales  $\sqrt{r}L(k) = L(k_{eff})$ ,  $k_{eff} = k + k_d$ , of intermediate gauge bosons  $Z, W$ , d and u quarks, and electron for the values  $r = 2^{k_d}$  of Planck constant defined in Table 5. The uppermost row gives the integers characterizing the p-adic length scales of the particles for the standard value of Planck constant.  $k_{eff}$  characterizes also the CD times scale through the formula  $T(CD, k_{eff}) = 2^{k_{eff}-127} \times .1$  seconds. The rows which correspond to the less general option for which only  $M_{89}$  corresponds to weak bosons with ordinary value of Planck constants have double underline and the corresponding values of  $k_d$  are in boldface.

$k_1$	$k_M$	$k_1$	$k_M$	$k_1$	$k_M$	$k_1$	$k_M$
113	89	113	107	163	127	163	157
127	89	119	107	167	127	169	157
151	89	123	107	133	127	173	157
157	89	113	107	139	127	163	157
163	89	117	107	143	127	167	157
167	89	111	107	133	127	161	157
95	89	175	113	137	127	169	163
109	89	181	113	131	127	183	163
133	89	187	113	225	151	207	163
139	89	191	113	229	151	213	163
145	89	119	113	157	151	219	163
149	89	133	113	171	151	223	163
103	89	157	113	195	151	177	163
127	89	163	113	201	151	201	163
133	89	169	113	207	151	207	163
139	89	173	113	211	151	213	163
143	89	127	113	165	151	217	163
113	89	151	113	189	151	187	163
119	89	157	113	195	151	193	163
125	89	163	113	201	151	199	163
129	89	167	113	205	151	203	163
95	89	137	113	175	151	169	163
101	89	143	113	181	151	175	163
105	89	149	113	187	151	179	163
95	89	153	113	191	151	169	163
99	89	119	113	157	151	173	163
93	89	125	113	163	151	167	163
145	107	129	113	167	151	187	167
169	107	119	113	157	151	211	167
175	107	123	113	161	151	217	167
181	107	117	113	155	151	223	167
185	107	195	127	235	157	227	167
113	107	201	127	163	157	181	167
127	107	205	127	177	157	205	167
151	107	133	127	201	157	211	167
157	107	147	127	207	157	217	167
163	107	171	127	213	157	221	167
167	107	177	127	217	157	191	167
121	107	183	127	171	157	197	167
145	107	187	127	195	157	203	167
151	107	141	127	201	157	207	167
157	107	165	127	207	157	173	167
161	107	171	127	211	157	179	167
131	107	177	127	181	157	183	167
137	107	181	127	187	157	173	167
143	107	151	127	193	157	177	167
147	107	157	127	197	157	171	167

ĩ

Table 9. The table gives all weak boson length scales -both non-dark and dark implied by the assumption that all Mersennes primes and their Gaussian counterparts and their dark counterparts defined  $k_d = k_i - k_j$  them are possible.



particle	$Z, W$	d	u	e
k	89	120	123	127
f(CD)/Hz	$2.7488 \times 10^{12}$	1280	160	10

Table 8. The fundamental frequencies associated with the CDs of intermediate gauge bosons  $Z, W$ , d and u quarks, and electron. Note that for intermediate gauge bosons the frequency of CDs corresponds to energy  $E = 1.13 \times 10^{-2}$  eV and wavelength  $\lambda = 1.01 \times 10^{-4}$  m (size of a large neuron).

$Z, W$	d	u	e	$k_d$
3.64e-13	7.81e-04	6.25e-03	1.00e-01	<b>0</b>
5.821e-12	1.25e-02	1.00e-01	1.60e+00	4
2.31e-11	5.00e-02	4.00e-01	6.40e+00	6
3.73e-10	8.00e-01	6.40e+00	1.02e+02	10
1.49e-09	3.20e+00	2.56e+01	4.10e+02	12
5.97e-09	1.28e+01	1.02e+02	1.65e+03	14
2.38e-08	5.12e+01	4.10e+02	6.55e+03	16
9.54e-08	2.05e+02	1.64e+03	2.62e+04	<b>18</b>
3.81e-07	8.19e+02	6.55e+03	1.05e+05	20
6.10e-06	1.31e+04	1.05e+05	1.68e+06	<b>24</b>
3.91e-04	8.39e+05	6.71e+06	1.07e+08	30
2.50e-02	5.37e+07	4.30e+08	6.87e+09	36
1.00e-01	2.15e+08	1.72e+09	2.75e+10	<b>38</b>
4.00e-01	8.59e+08	6.87e+09	1.10e+11	40
6.40e+00	1.37e+10	1.10e+11	1.76e+12	44
4.10e+02	8.80e+11	7.04e+12	1.12e+14	50
6.55e+03	1.41e+13	1.13e+14	1.80e+15	54
2.62e+04	5.63e+13	4.50e+14	7.21e+15	56
4.19e+05	9.01e+14	7.21e+15	1.15e+17	60
1.68e+06	3.60e+15	2.88e+16	4.61e+17	<b>62</b>
1.07e+08	2.31e+17	1.84e+18	2.95e+19	<b>64</b>
6.87e+09	1.48e+19	1.18e+20	1.89e+21	<b>74</b>
1.10e+11	2.36e+20	1.89e+21	3.02e+22	<b>78</b>

Table 9. The  $\hbar$ -scaled fundamental time scales  $T(CD, k_{eff}) = 2^{k_{eff}-127} \times .1$  seconds associated with the CDs of intermediate gauge bosons  $Z, W$ , d and u quarks, and electron for the values  $\hbar/\hbar_0 = 2^{k_d}$  of Planck constant defined in Table 5. The scales are expressed in seconds. The uppermost row gives the time scales of CDs for the standard value of Planck constant. The rows which correspond to the less general option for which only  $M_{89}$  corresponds to weak bosons with ordinary value of Planck constants have double underline and the corresponding values of  $k_d$  are in boldface.

### Electron and $u$ quark are different

Before continuing an important observation is in order. Electron is exceptional when compared to quarks. It appears as a dark particle in all p-adic length scales defined by biologically important Gaussian Mersennes and also in atomic length scales  $k = 137$  and  $k = 139$ . The reason is trivial: by the basic assumptions electron must appear at same length scales as weak bosons above  $k = 127$  since it corresponds to Mersenne prime. Also for the less general option (exotic intermediate gauge bosons are possible only as the dark variants of the standard ones) it appears at cell membrane length scale  $k = 151$ , which is due to the fact that one has  $113 - 89 = 151 - 127 = 24$ . Also  $u$  quark can appear with  $k_{eff} = 137, 139, 163, 167$  and also this is an accident. The light invariants

of intermediate gauge bosons appearing in long p-adic length scales would naturally correspond to almost vacuum extremals making possible the criticality as the basic aspect of life. One must of course be very cautious about the masses of exotic counterparts of  $u$  and  $d$  quark: one can also consider the possibility that masses are identical.

### 8.4.2 Dark matter hierarchy and big leaps in evolution

Dark matter hierarchy leads to an amazingly concrete picture about evolutionary hierarchy allowing to identify the counterparts for concepts like mineral, plant, and animal kingdom that we learned during schooldays and ceased to take seriously as students of theoretical physics as we learned that other sciences are just taxonomy. Even more, a view about what distinguishes between prokaryotes, eukaryotes, animal cells, neurons, EEG, and even about what makes cultural evolution, becomes possible. This view is also very useful when one tries to understand the role of microtubules.

The appearance of CDs scaled up in size by  $r = \hbar/\hbar_0$  and space-time sheets scaled up in size by  $\sqrt{r}$  means the emergence of new levels of structure and it is natural to identify big leaps in evolution in terms of emergence of new larger matter carrying space-time sheet magnetic flux sheets and corresponding magnetic bodies. If magnetic flux quanta are scaled by  $r$  magnetic flux quantization conditions remain unaffected if magnetic field strengths scale down by  $1/r$  so that the energies of cyclotron photons are not affected. The thickness of flux tubes can remain unchanged if the currents running at the boundaries of the flux quantum cancel the magnetic flux. As already found, this mechanism must be at work inside living organisms whereas in far away region flux quanta are scaled up in size.

The attractive hypothesis is that the leaps in evolution correspond to the emergence of dark variants of weak and possibly also color interactions in dark p-adic length scales which correspond to ordinary p-adic length scales characterized by Mersenne primes. These leaps would be quantum leaps but in different sense as thought usually. The emergence of higher dark matter levels would basically mean the integration of existing structures to larger structures. A good metaphor are text lines at the pages of book formed by magnetic flux sheets whose width is scaled up by  $r$  as the new level of dark matter hierarchy emerges. The big leaps can occur both at the level of organism and population and organisms with rather low individual dark matter level can form societies with high dark matter levels and high collective intelligence (honeybees and ants are good example in this respect).

Certainly also other scalings of Planck constant than those summarized in tables are possible but these scalings are of primary interest. This intuition is supported by the observation that electron is completely exceptional in this framework. Electron's dark p-adic length scales corresponds to p-adic length scales  $L(k)$ ,  $k = 167, 169$ , assignable to atomic and molecular physics and to the Gaussian Mersennes  $M_{G,k} = (1+i)^k - 1$ ,  $k \in \{151, 157, 163, 167\}$ , assignable to the length scale range between cell membrane thickness 10 nm and nucleus size 2.58  $\mu\text{m}$ . The corresponding p-adic length scales or corresponding electronic Compton lengths, the number of which is 23, are excellent candidates for the scales of basic building bricks of living matter and vary from electron's p-adic length scale up to 1.25 m ( $k = 167$  defining the largest Gaussian Mersenne in cell length scale range) and defining the size scale of human body. The corresponding p-adic time scales are also highly interesting and vary from .1 seconds for electron defining the fundamental biorhythm to  $9.6 \times 10^{14}$  years which is by 4-5 orders longer than the age of the observed Universe. For  $k = 167$  the time scale is  $1.1 \times 10^{11}$  years and is by one order of magnitude longer than the age of the observed Universe estimated to be  $1.37 \times 10^{10}$  years [E1].

This conceptual framework gives rather strong guidelines for the identification of the levels of evolutionary hierarchy in terms of dark matter hierarchy. The outcome is a more detailed vision about big evolutionary leaps. Note that in the sequel only the general option is considered: the justification for this is that for this option electron appears as a dark particle for all length scales defined by Gaussian Mersennes as well as in atomic length scales. The basic vision in nutshell is that evolution means the emergence of dark weak and gluonic physics in both dark and ordinary length scales and that the size scales of the basic biostructures correspond to Mersenne primes and their Gaussian variants.

### A sketch about basic steps in evolution

The vision about evolution depends on what one assumes about the initial state.

1. If one assumes that weak bosons with ordinary value of Planck constant were present in the beginning, evolution would mean a steady growth of  $k_d$ . The problem is that small values of  $k_d = k_1 - k_2$  correspond to the Gaussian Mersennes defining cellular length scales. If these exotic weak physics were present from the beginning, large parity breaking in cellular length scales would have been present all the time.
2. An alternative and perhaps more realistic view is that the evolution means the emergence of exotic weak physics corresponding almost vacuum extremals in increasingly longer length scales. A possible mechanism could have been the induction of exotic  $\hbar_0$  variant of weak physics at the nearest Mersenne length scale  $k_{next}$  by the dark variant of weak physics at level  $k$  so that one would have  $k_d = k_{next} - k$ . The simplest induction sequence would have been  $89 \rightarrow 107 \rightarrow 113 \rightarrow 127 \rightarrow 151 \rightarrow 157 \rightarrow 163 \rightarrow 167$  corresponding to  $k_d \in \{18, 6, 14, 24, 6, 6, 4\}$ . A possible interpretation of exotic  $\hbar_0$  physics is in terms of almost vacuum extremals and non-standard value of Weinberg angle: also weak bosons of this physics would be light. This sequence defines the minimal values for  $k_d$  but also larger values of  $k_d$  are possible and would correspond to steps between neighbours which are not nearest ones.

The following sketch about the basic steps of evolution relies on the latter option.

#### 1. Elementary particle level

Magnetic bodies with size scale defined by the sizes of CDs assignable to quarks and leptons and possibly also weak bosons (already now the size of big neuron emerges) corresponds to the lowest level of hierarchy with the sizes of the basic material structures corresponding to the Compton lengths of elementary particles. The fundamental bio-rhythms corresponding to frequencies 10, 160, and 1280 Hz appear already at this level in zero energy ontology which suggests that elementary particles play a central and hitherto unknown role in the functioning of living matter.

#### 2. $89 \rightarrow 107$ step with $k_d = 18$

The first step would have been the emergence of  $k_{eff} = 107$  weak bosons inducing  $\hbar_0$  weak physics in  $k = 107$  length scale characterizing also ordinary hadrons. This in turn would have led to the emergence of exotic nucleons possibly corresponding to almost vacuum extremals. The reduction of the model for the vertebrate genetic code to dark hadron physics [K81] is one of the most unexpected predictions of quantum TGD and assumes the existence of exotic- possibly dark- nucleons whose states with a given charge correspond to DNA, RNA, mRNA, and tRNA. The  $\hbar_0$  variants of these nucleons would interact via weak bosons with hadronic mass scale. The exotic variants of the ordinary  $k = 113$  nuclei would correspond to the nuclear strings consisting of exotic nucleons [K17, K81] and define nuclear counterparts for DNA sequences. Their dark counterparts could define counterparts of DNA sequences in atomic physics length scales. Therefore a justification for the previous observation that genetic code could be realized at the level of hadron physics and that chemical realization would be higher level realization finds justification. The anomalous properties of water could be also partly due to the presence of dark nucleons and the proposal was that the presence of exotic nuclei is involved with water memory [K32]. The possible existence of the the analog of DNA-RNA transcription between ordinary DNA and its nuclear counterpart would have dramatic implications. For instance, one can imagine a mechanism of homeopathy based on this kind of transcription process which would also allow a modification of genome by using dark nuclei to communicate the DNA sequences through the cell membrane to the target nuclei.

#### 3. $107 \rightarrow 113$ step with $k_d = 6$

The next step would have been the emergence of  $k_{eff} = 113$  weak bosons inducing  $\hbar_0$  weak physics in  $k = 113$  length scale characterizing also ordinary hadrons. Exotic variants of the ordinary nuclei possibly corresponding to almost vacuum extremals could have emerged interacting weakly (or actually relatively strongly!) via the exchange of weak bosons with mass scale of order 100 MeV. Also dark variants of the exotic  $k = 107$  nucleons could have emerged and formed exotic nuclei of size scale  $k = 119$ .

4. 113  $\rightarrow$  127 step with  $k_d = 14$ 

At this step weak bosons in electron mass scale would have emerged. Whether these weak bosons could have induced large parity breakings in atomic and molecular length scales is not clear. Viruses, which do not yet possess cell membrane could correspond to this level of hierarchy.

5. 127  $\rightarrow$  151 step with  $k_d = 24$ 

This step would have been fundamental since weak bosons in cell membrane length scale would have appeared. Note that by  $113 - 89 = 24$  this step also leads from  $k = 89$  weak bosons to  $k = 113$  weak bosons. The weak bosons assignal to  $k = 151$  could correspond to the weak interactions associated with almost vacuum extremals and  $\sin^2(\theta_W) = .0295$  could correspond to the weak physics in question.

$k_d = 24$  step for  $k = 113$   $\hbar_0$  weak bosons would have produced them in  $k_{eff} = 137$  atomic length scale with  $L(137) \simeq .78$  Angstrom This could have naturally led to large parity breaking effects and chiral selection.

Dark  $k_{eff} = 151$  electrons appearing in the TGD inspired model of high  $T_c$  super-conductivity would have been a by-product of this step. Whether dark electrons could have transformed to light  $\hbar_0$  electrons (of mass .25 keV) with a common mass scale of order  $10^2$  eV with exotic weak bosons is an interesting question. The model of high  $T_c$  super-conductivity predicts the presence of structures analogous to cell membrane. This would suggest that cell membranes emerged and chiral selection emerged at this step so that one could not distinguish the emergence of molecular life as a predecessor for the emergence of cell membrane like structures. This would conform with the fact that DNA molecules are stable only inside cell nucleus. Note that for  $k_{eff} = 151$  electron's CD has time scale  $2^{24} \times .1$  seconds -that is 19.419 days (day=24 hours).

The smallest nanobes [I7] appearing in rocks have size 20 nm and could have emerged at this step. The size of the viruses [I14] is between 10-300 nm covers the entire range of length scales assignable to Gaussian Mersennes, which suggests that smallest viruses could have emerged at this step. Also the smallest [I6] [I6], which by definition have size smaller than 300 nm could have appeared at this stage.

## 6. The remaining steps

The remaining steps  $k = 151 \rightarrow 157 \rightarrow 163 \rightarrow 167$  could relate to the emergence of coiling structure DNA and other structures inside cell nucleus.  $k = 167$  would correspond to  $k_d = 167 - 89 = 68$  to be compared with the value  $k_d = 47$  required by 5 Hz Josephson frequency for the neuronal membrane for -70 mV resting potential. Note that  $k_d = 48$  (state 1-2 of deep sleep) corresponds to  $k = 163$ .

By their smallness also double and triple steps defined by  $k_d = k_{i+n} - k_i$ ,  $n > 1$ , are expected to be probable. As a consequence, electrons can appear as dark electrons at all the Gaussian Mersenne levels. At these steps the dark electrons corresponding to primes  $k_{eff} = 137, 139$  would appear. For  $k = 137$  dark electron appears with CD time scale equal to 128 seconds- rather precisely two minutes. The model for EEG suggests that the exotic weak bosons appear in the scales  $k_{eff} = 136, 137, 138$ .

Further multisteps from the lower levels of hierarchy would give structures with size scales above the size of cell nucleus possibly assignable to organs and structural units of brain. The dark levels assignable to electron are expected to be of special interest. It is encouraging that the longest scale assignable to electron in this manner corresponds to  $k = 205$  and length scale of 1.28 m defining body size. As a consequence dark electrons are predicted at levels  $k = 137, 139, 141, 143, 145, 147$  coming as octaves.

Prokaryotic cells (bacteria, archea) without cell nucleus for which cell membrane is responsible for metabolic functions and genome is scattered around the cell could have emerged at this step. This would mean that the emergence of the cell membrane thickness as a fundamental scale is not enough: also the size scale of membrane must appear as p-adic length scale. The sizes of most prokaryotes vary between 1  $\mu\text{m}$  and 10  $\mu\text{m}$ : the lower bound would require  $k = 163$ . There also prokaryotes with sizes between .2  $\mu\text{m}$  ( $k = 157$  corresponds to .08  $\mu\text{m}$ ) and 750  $\mu\text{m}$ . Cell nuclei, mitochondria, and other membrane bounded cell nuclei would have evolved from prokaryotes in this framework. The sizes of eukaryote cells are above 10  $\mu\text{m}$  and the fact that multicellular organisms are in question strongly suggests that the higher multisteps giving rise to weak bosons and dark

electrons in length scales above  $L(167)$  are responsible for multi-cellular structures.

This scenario leaves a lot of questions unanswered. In particular, one should understand in more detail the weak physics at various length scales as well as various exotic nuclear physics defined by dark nucleons and dark variants of nuclei.

### Division of the evolution to that of biological body and magnetic body

Electron's Mersenne prime  $M_{127}$  is the highest Mersenne prime, which does not correspond to a completely super-astrophysical p-adic length scale. In the case of Gaussian Mersennes  $M_{G,k}$  one has besides those defined by  $k$  in  $\{113, 151, 157, 163, 167, \dots\}$  also the ones defined by  $k$  in  $\{239, 241, 283, 353, 367, 379, 457, 997\}$  [A1]. The appropriately extended model for evolution allows to distinguish between three kinds of values of  $k_{eff}$ .

1. The values of  $k_{eff}$  for which electron can appear as dark particle and thus satisfying  $k_{eff} \leq 205$  (Table 5). These levels would correspond to structures with size below 1.25 m defined roughly by human body size and it is natural to assign the evolution of super-nuclear structures to the levels  $167 < k_{eff} \leq 205$ .
2. The values of  $k_{eff}$  for which dark gauge bosons are possible in the model. This gives the condition  $k_{eff} \leq 235$ . These levels correspond to structures in the range 1.25 m-40 km. The identification as parts of the magnetic body can be considered.
3. The values of  $k_{eff}$  obtained by adding to the system also the Gaussian Mersenne pair  $k \in \{239, 241\}$  allowing also the dark electrons. The lower size scale for these structures is 640 km.
4. The higher levels corresponding to  $k_{eff}$  in  $\{283, 353, 367, \dots\}$ . The lower size scale for these structures is 3 AU (AU is the distance from Earth to Sun).

$k_{eff} > 205$  levels would correspond to the emergence of structures having typically size larger than that of the biological body and not directly visible as biological evolution. This evolution could be hidden neuronal evolution meaning the emergence of extremely low Josephson frequencies of the neurons modulating higher frequency patterns and being also responsible for the communication of long term memories.

### Biological evolution

In principle the proposed model allowing multisteps between hierarchy levels defined by Mersenne primes and their Gaussian counterparts could explain the size scales of the basic structures below the size scale 1.25 m identified in terms of the  $k_{eff} \leq 205$  levels of the hierarchy.

#### 1. The emergence of cells having organelles

The appearance of the structures with  $k_{eff} > 167$  (possibly identifiable as magnetic body parts) should correlate with the emergence of simple eukaryotic cells and organisms, in particular plant cells for which size is larger than  $10 \mu\text{m}$ , which could correspond to  $k_{eff} = 171$  for electron and dark variants of weak gauge bosons.  $k_{eff} = 177$  is the next dark electron level and corresponds to  $80 \mu\text{m}$  scale. It seems natural to assume that these dark weak bosons do not transform to their  $\hbar_0$  counterparts at these space-time sheets.

Cell nucleus would be the brain of the cell, mitochondria would be the energy plant, and centrioles generating microtubules would define the logistic system. Also other organelles such as Golgi apparatus, ribosomes, lysosomes, endoplasmic reticulum, and vacuoles would be present. These organelles would live in symbiosis by topologically condensing to  $k_{eff} \geq 171$  magnetic body controlling their collective behavior. Centrosomes associated with animal cells would not be present yet but microtubule organizing centers would already be there.

The recent observations show that centrioles are not always in the characteristic T shaped conformation. Daughter centrioles resulting during the replication of mother centriole use first ours of their lifetime to roam around the cell before becoming mature to replicate. A possible interpretation is that they are also life forms and that magnetic body utilizes daughter centrioles

to perform some control functions crucial for the future development of the cell. For instance, centrioles visit the place where axonal growth in neurons starts.

Cytoskeleton would act as a counterpart of a central nervous system besides being responsible for various logistic functions such as transfer of proteins along microtubuli. Centrioles give also rise to basal bodies and corresponding cilia/flagella used by simple cells to move or control movement of air or liquid past them. Centriole pair would be also used by the magnetic body to control cell division.

The logistic functions are the most obvious functions of microtubules. Magnetic body would control cell membrane via signals sent through the cell nucleus and communicated to the cell membrane along microtubuli. Basal bodies below the cell membrane and corresponding cilia/flagella would serve as motor organs making possible cell motion. Tubulin conformations representing bits would allow microtubule surface to represent the instructions of the magnetic body communicated via cell nucleus to various proteins moving along the microtubular surface so that they could perform their functions.

TGD based view about long memory recall as communication with geometric past allows also the realization of cellular declarative memories in terms of the conformational patterns. Memory recall corresponds to a communication with geometric past using phase conjugate bosons with negative energies reflected back as positive energy bosons and thus representing an "image" of microtubular conformation just like ordinary reflected light represents ordinary physical object. There would be no need for a static memory storage which in TGD framework would mean taking again and again a new copy of the same file.

Receptor proteins would communicate cell level sensory input to the magnetic body via MEs parallel to magnetic flux tubes connecting them to the magnetic body. We ourselves would be in an abstract sense fractally scaled up counterparts of receptor proteins and associated with dark matter iono-lito Josephson junction connecting the parts of magnetosphere below litosphere and above magnetosphere. The communication would be based on Josephson radiation consisting of photons, weak bosons, and gluons defining the counterpart of EEG associated with the level of the dark matter hierarchy in question.

### 3. *The emergence of organs and animals*

The emergence of magnetic bodies with  $k_{eff}$  in the range (177, 181, 183, 187, 189, 195, 201, 205) allowing both dark electron and weak bosons could accompany the emergence of multicellular animals. Magnetic body at this level could give rise to super-genome making possible genetic coding of organs not yet possessed by plant cells separated by walls from each other. The super structures formed from centrosomes and corresponding microtubuli make possible complex patterns of motion requiring quantum coherence in the scale of organs as well as memories about them at the level of organs.

### 4. *The emergence of nervous system*

$k_{eff}$  in the range (187, 189, 195, 201, 205) allowing dark electrons and weak bosons gives size scales (.25, .5, 4, 32, 128) cm, which could correspond to the scales of basic units of central nervous system. What would be of special interest would be the possibility of charged entanglement based on classical  $W$  fields in macroscopic length scales. The emergence of the new level means also the integration of axonal microtubuli to "text lines" at the magnetic flux sheets making possible logistic control at the multineuronal level. The conformational patterns of the microtubular surface would code nerve pulse patterns to bit patterns representing declarative long term memories. An interesting question is whether the reverse coding occurs during memory recall.

## **The evolution of magnetic body**

For mammals with body size below 1.25 m the levels  $k_{eff} > 205$  cannot correspond to biological body and the identification in terms of magnetic body is suggestive. The identification of EEG in terms of Josephson frequencies suggests the assignment of EEG with these levels.

### 1. *The emergence of EEG*

EEG in the standard sense of the word is possessed only by vertebrates and one should understand why this is the case. The value of Josephson frequency equal to 5 Hz requires only  $k_d = 47$

so that something else must be involved. A possible explanation in the framework of the proposed model comes from the following observations.

1. Besides the maximal p-adic scale  $k = 205$  for which electron and weak bosons appears as dark variants the model allows also levels at which only gauge bosons appear as dark particles. From Table 9 one finds that levels  $k \in \{207, 211, 213, 217, 219, 221, 223, 225, 229, 235\}$  are allowed. Could it be that these levels and possibly some highest levels containing both electrons and gauge bosons as dark particles are a prerequisite for EEG as we define it. Its variants at higher frequency scales would be present also for invertebrates. The lowest Josephson frequency coded by the largest value of  $\hbar$  in the cell membrane system determines the Josephson frequency.
2. The membrane potentials -55 mV (criticality against firing) correspond to ionic Josephson energies somewhat above 2 eV energy ((2.20,2.74,3.07,2.31) eV, see Table 1). For 2 eV the wavelength 620 nm is near to  $L(163) = 640$  nm. Therefore the Josephson energies of ions can correspond to the  $L_e(k = 163)$  if one assumes that a given p-adic mass scale corresponds to masses half octave above the p-adic mass scale so that the opposite would hold true at space-time level by Uncertainty Principle. Josephson frequencies  $f_J \in \{5, 10, 20, 40, 80, 160\}$  Hz correspond to  $k_d \in \{47, 46, 45, 44, 43, 42\}$  giving  $k_{eff} \in \{210, 209, 208, 207, 206, 205\}$ .
  - (a) Cerebellar resonance frequency 160 Hz would correspond to  $k = 205$  -the highest level for for which model allows dark electrons (also 200 Hz resonance frequency can be understood since several ions are involved and membrane potential can vary).
  - (b) The 80 Hz resonance frequency of retina would correspond to  $k_{eff} = 206$  -for this level dark electrons would not be present anymore.
  - (c) 40 Hz thalamocortical frequency would correspond to  $k_{eff} = 207$ .
  - (d) For EKG frequencies are EEG frequencies below 20 Hz 12.5 and heart beat corresponds to .6-1.2 second cycle (the average .8 s corresponds to  $k_{eff} = 212$ ).
3. Even values of  $k_{eff}$  are not predicted by the model based on Mersenne primes allowing only odd values of  $k_{eff}$  so that the model does not seem to be the the whole truth. The conclusion which however suggests itself strongly is that EEG and its variants identified as something in the range 1-100 Hz, are associated with the levels in at which only dark weak bosons are possible in the proposed model. Note that the size scales involved with EEG would be above the size scale of human body so that we would have some kind of continuation of the biological body to be distinguished from the magnetic body. The time scales assignable to the dark CDs would be huge: for instance,  $k = 205$  would correspond to  $T = 2^{42} \times .1s$  making about 1395 years for electron.

2. *Does magnetic body correspond to the space-time sheets carrying dark weak bosons?*

The layers of the magnetic body relevant for EEG have have size of order Earth size. Natural time scale for the moment of sensory consciousness is measured as a fraction of second and the basic building blocks of our sensory experience corresponds to a fundamental period of .1 seconds. This scale appears already at  $\hbar_0$  level for electron CD. The natural question concerns the relationship of the magnetic body to the  $k > 205$  space-time sheets carrying only gauge bosons in the model and having size scale larger than that of biological body. Do they correspond to an extension of biological body or should they be regarded as parts of the magnetic body? The following observations suggest that they could correspond to layers of the magnetic body responsible for the fractal variant of EEG.

1. The primary p-adic time scales (Compton times)  $T(239)$  and  $T(241)$  correspond to frequencies, which are  $2^{\pm 1/2}$  kHz. The geometric average  $k = 240$  corresponds to kHz frequency. Is the appearance of kHz scale a mere accident or do the frequencies assignable to the quark CDs correspond to Compton times  $\propto \sqrt{2^{k_{eff}/2}}$ ?
2. One can apply scalings by  $2^{k_d}$  to the triplet (239, 240, 241) to get a triplet  $(239 + k_d, 240 + k_d, 241 + k_d)$ . The results are summarized in Table 10. Clearly the frequencies in question

cover also the EEG range. Note that these frequencies scale as  $\sqrt{1/r}$  whereas Josephson frequencies scale as  $1/r$ .

$k_d$	$f_1/Hz$	$f_2/Hz$	$f_3/Hz$
0	707	1000	1412
4	177	250	354
6	89	1250	177
10	22.1	31.3	44.2
12	11.1	15.6	22.1
14	5.5	7.8	11.1
16	2.8	3.9	5.5
18	1.4	2.0	2.8
20	0.7	1.0	1.4
24	0.2	0.2	0.3

Table 10. The Compton frequencies obtained by scaling  $2^{k_d/2}$  from the basic triplet  $k_{eff} = (239, 240, 241)$ . The values of  $k_d$  correspond to those predicted by the model based on Mersenne primes.

Also ZEG and WEG would appear but in much shorter scales dictated by  $k_{eff}$  and might accompany EEG. Somehow it seems that the effective masslessness of weak bosons below given scale is highly relevant for life. One can of course ask whether some larger Gaussian Mersenne could change the situation. There is a large gap in the distribution of Gaussian Mersennes after  $k = 167$  and the next ones correspond to  $M_{G,k}$ , with  $k$  in  $(239, 241, 283, 353, 367, 379, 457, 997)$  [A1]. The twin pair  $k = (239, 241)$  corresponds to a length scales  $(1.6, 3.2) \times 10^2$  km and the minimum value for  $k_d$  are  $(72, 74)$  ( $167 \rightarrow (239, 241)$  transition).

### 3. Long term memory and ultralow Josephson frequencies

What determines the time scale associated with long term memory is a crucial question if one really wants to understand the basic aspects of consciousness.

1. Does the time scale correspond to the size scale of CD assignable to electron scaled by  $r = \hbar/\hbar_0$ ? In this case relatively small values of  $r$  would be enough and  $r = 2^{47}$  would give time scale of  $10^{13}$  s for for electron's CD, which is about  $3 \times 10^5$  years. This does not make sense.
2. Does Josephson frequency define the relevant time scale? In this case the long term memory would require the analog of EEG in the time scale of memory span.  $k_{eff} = 205$  would give 6 ms time scale for memory from the assignment of  $k_{eff} = 163$  to the Josephson photons at  $V = -50$  mV implying  $k_d = 42$ . Minute scale would require  $k_{eff} = 217$ . The highest level  $k_{eff} = 235$  allowed by the model involving only Gaussian Mersennes with  $k \leq 167$  would correspond to a time scale of 77.67 days (day is 24 hours). For Gaussian Mersennes defined by  $k_{eff} = (239, 241)$  the time scales become about  $(41.4, 82.8)$  months (3.4 and 6.8 years). These scales should also define important biorhythms. The claimed 7 years rhythm of human life could relate to the latter rhythm: note that the precise value of the period depends on the membrane potential and thus varies. The presence of the scaled up variants of the by  $k_d \leq 78$  allows longer time spans of long term memory and the scaling defined by  $k_d = 167 - 163 = 4$  scales up the span of long term memories to  $(54.4, 108.8)$  years.

### 4. Cultural evolution

Higher levels in the hierarchy would correspond mostly to the evolution of hyper-genome coding for culture and social structures. Introns are good candidate for the nucleotides involved. The development of speech faculty is certainly a necessary prerequisite for this breakthrough. Already EEG seems to correspond to dark layers of biological body larger than biological body so that one can ask whether the weak bosons and dark electrons in the length scales



$k = 239, 241, 283, 353, 367, \dots$  could be relevant for the collective aspect of consciousness and cultural evolution. Maybe the size scales (175, 330) km and their scaled up variants by  $k_d \leq 78$  might have something to do with the spatial scale of some typical social structure (not city: the area of New York is only 790 km<sup>2</sup>).

### 8.4.3 Could insect colonies have "EEG"?

Only vertebrates can have EEG in 1-100 Hz range. According to the proposed model this means the presence of the  $k > 205$  levels which can be regarded as a continuation of the biological body carrying dark weak bosons and having size scales larger than 1.25 m. That only vertebrates have EEG conforms with the empirical findings about the effects of ELF em fields on vertebrate brain.

This does not however imply that one could not assign EEG to the collective levels of consciousness. For instance, in the case of social insects forming colonies some kind of collective EEG might exist and explain the ability of the colony to behave like single organism. Indeed, ELF magnetic field and magnetic fields affect the behavior of honeybees just as ELF em fields affect the behavior of vertebrates [I35]: the model for this findings led to a model for the fractal hierarchy of EEGs.

One could argue that insect brain is so simple (in the case of honeybee the number of neurons 1/1000 of number of neurons in human retina) that it is not possible to assign "personal" EEG to honeybee. The fact that a honeybee isolated from colony dies just as does the cell separated from organism, suggests that the relationship of insect to colony is like that of a cell to organism. Hence one could test whether colonies of social insects or their sub-colonies might possess an analog of ordinary EEG. What this would mean that ant colonies have sufficiently complex hyper-genome making possible collective variants of memory, sensory input, and intelligence, as well as the ability to realize collective motor actions. Even bacterium colonies have intricate social structures [I51] so that one must remain open minded.

An objection against this line of thinking is that even in the case of collective EEG the proposed model assigns the Josephson frequencies with neurons. One might imagine Josephson frequencies at EEG range even in case of insects- say the queen of the nest. Since dark photons are in question the fields are very weak. I do not know whether any-one has got the crazy idea about checking whether beehive has EEG -certainly not any routine measurement! One can also imagine a fractal counterpart of EEG at the level of some individuals- say queen of the nest- at very low frequencies making possible long term memory.

#### Do honeybees have long term memory?

The realization that insect colonies rather than insects might correspond to higher  $k_{eff} > 205$  levels of the dark matter hierarchy came via an indirect route. The article "Why honeybees never forget a face?" of New Scientist [I16] described evidence supporting the view that honeybees might possess long term memory in the time scale of days.

Adrian Dyer of the University of Cambridge and colleagues trained honeybees to associate a sucrose drink with a photograph of a particular face. The insects were then tested on their memory and recognition skills by being presented with the picture of this face and the pictures of three other faces not associated with any reward. Of the seven bees tested, two lost interest in the trial and flew away. But the five remaining bees correctly identified the target face in more than 80 per cent of trials, even though the reward had been removed. Moreover, some bees remembered the face two days later, indicating that they had formed a long-term memory of it.

1. The conservative explanation is that the achievement is due to keeping the face-honey association intact in the absence of the stimulus which created it in a time scale of days. For this option the ability of honeybee to express the distance and orientation to the food source could be hardwired involving no conscious memory about the flight. Also the interpretation of the honeybee dance telling the distance and orientation of food source to advices where to fly would be completely "instinctive"- whatever this means.
2. A more radical option is that honeybee hive rather than honeybee has long term memories in the sense as long term memories are interpreted in TGD framework: that is as communications with the geometric past. In this case the span of long term memories is determined by the level of dark matter hierarchy as time scale defined by Josephson frequency assignable

to level of dark matter hierarchy in question and a span of few days for long term memories forces the conclusion  $k_d \geq 63$ : the upper bound is  $k_d = 78$  (see Table 5), when one allows only  $k \leq 167$  Mersennes and this corresponds to 87.6 years.

One can ask whether the ability of honey bee queen to found a new honeybee colony could involve long term memory in the time scale of year. If this were the case, the queen would not face her formidable challenge alone: the former colony in the geometric past still exists as a conscious entity and could communicate advices to the queen. The magnetic body of the former colony could exist also in the geometric now, being physically associated with the queen. This magnetic body could serve as the conscious entity communicating to the queen the advices and commands making possible to construct the beehive. A more conservative explanation is that these activities are genetically hardwired and instinctive (leaving open what 'instinctive' really means if it actually means anything).

The distinguished social position and anatomy of queen are consistent with the hypothesis that queen has more massive connections than other bees with the magnetic body of beehive. For instance, it is known that the new hive is oriented in exactly the similar manner as the old. Either long term memory or passive magnetic coding of the orientation of the hive with respect to Earth's magnetic field made possible by the magnetite in the abdomen of queen could explain this. The neurons of queen could correspond to a very large value of  $\hbar$  giving rise to the required low Josephson frequencies.

The colony would have sensory resolution in a time scale of a fraction of second and short term memory in minute time scale. The counterpart of EEG at the level of hive is highly suggestive and conforms with the finding that ELF magnetic fields with strengths in the range .1-1 mT ( $2B_E - 20B_E$  affect honeybee dance [I35] as does also the absence of Earth's magnetic field. Interestingly, 1-2 mT DC field causes epileptiform activity in the case of humans [I26] (the change of the DC field used seems to be more important than the period it is applied). Could the beehive suffer a kind of epileptic seizure!

The intentional actions of the honeybee colony would be realized via magnetic flux sheets traversing the super-genes of the insects participating to the action in question. Workers, soldiers, etc.. would act to some extent as organs of the colony being connected by hyper-genes of hyper-genome to larger units. Queen could act as the analog of a complex Grand Mother neuron in brain or a leader in human society.

This view can be criticized. Honeybee dance [I5] is performed by forager bees and the dance represents among other things the angle between the lines connecting hive to the food source and sun as the angle between movement of bee and vertical direction (also other options are possible). The intricate pattern of the dance in turn codes for the distance to the food source. If beehive is a conscious entity using bees as its cells, why is honeybee dance needed at all? TGD based vision about the evolution of modern human society from a bicameral society in which individuals received advice and commands from "God" [K64, K65], suggests an answer to this criticism. The society able to survive must be maximally flexible and allow maximal individual intelligence and maximal freedom of individual actions consistent with the overall goals. This requires delegation of simple tasks to lower levels meaning also that communications between individuals become necessary (the development of language and other communications parallels the transition from bicamerality to modern society in the case of humans). The communication itself might however involve also the beehive. Foreagers could be like the prophets of the bicameral society communicating in semitrance the advices of God to the colony.

It should be noticed in passing that honeybees have already earlier made a visit to TGD inspired theory of consciousness [K29]. As discovered by topologist Barbara Shipman [A11], honeybee dance has a mathematical description in terms of a construct assignable to color group  $SU(3)$  of gauge interactions between quarks and gluons. This led her to propose that color interactions might have some deep role in living matter. This is in a sharp contrast to the fact that color interactions as establishment knows them are completely invisible above the length scale of  $10^{-15}$  meters. The TGD based prediction that there exists an entire hierarchy of scaled up copies of QCD, in particular QCDs with confinement length scale of order cell size, changes completely the situation.

### Honeybees as magneto-receptors of the beehive or magnetic cells as magneto-receptors of bee?

Earth's magnetic field has a crucial status in the model of living systems even at the lowest levels of dark matter hierarchy so that Earth's magnetic field is expected to play a role in the functioning of all cells, also bees and ants. This is indeed the case.

It is known that that bees have two navigation systems. The first system is based on the direction of sun and polarization of solar light but does not work on cloudy days. The second navigation system uses Earth's magnetic field and is used in cloudy days. Bees have in their abdomen magnetite ( $\text{Fe}_3\text{O}_4$ ) particles of size about 30 nm and iron storage protein ferritin which correspond 10 to nm sized super-paramagnetic particles [I27]. Magnetite particles and ferritin in principle make possible magneto-reception instead of a mere passive compass behavior.

The minimum option is that honeybee itself does not receive any neural information about the magnetic field but acts as a passive magneto-receptor of the bee colony or sub-colony (such as workers flying to the food source) and that the information contained by the receptor grid allows the sub-colony to deduce its position in the varying magnetic field. "BEEG" would mediate this information to the magnetic body of the (sub-)colony and the general mechanism based on Josephson currents does not require nerve pulse patterns to achieve this.

Since foreagers seem to act as individuals able to navigate in the magnetic field of Earth, it would seem that some cells of the honeybee could act as magneto-receptors so that the reaction of the magnetic particles would be coded to a neural signal. It has been proposed that the changes in the shape of the configurations formed by magnetite particles in a varying magnetic field induce changes in the shape of neuron and in this manner can induce neural signal. This mechanism could also induce the voltage perturbations coding the information to the Josephson current giving rise to the sensory part of EEG as a state of coherent ELF photons. Perhaps the genes expressing these neurons are activated only in foragers and ferritin makes possible the magneto-reception in this sense.

### Social bacteria and magneto-tactic bacteria

Magneto-tactic behavior of bacteria [I20] was discovered for 30 years ago by microbiologist Richard P. Blakemore and means that certain motile, aquatic bacteria orient and migrate along magnetic field lines. This ability could be purely passive compass mechanism made possible by the magnetite detected in the bacteria.

During last years we have learned that bacteria are not simple creatures having only single goal: to multiply and fill the Earth. Bacteria are able to communicate and act co-operatively [I51]. This raises the question whether hyper-genes could appear already at this level and whether bacteria acting as a colony they individual bacteria could act as magneto-receptors of colony allowing it to detect even variations of the magnetic field much like individual cells in the brain of vertebrates or perhaps even in the abdomen of honeybee are believed to serve as magneto-receptors.

### Great leaps in evolution as emergence of higher levels of dark matter hierarchy at level of individuals

The vision about great leaps in evolution led to the view that the emergence of EEG corresponds to the emergence of  $k_{eff} > 205$  levels of dark matter hierarchy. On the other hand, the time scale of gene translation corresponds to that associated with the ordinary EEG, which forces to ask whether these levels are present already in the lowest life forms. Perhaps a more plausible option is that the .1 second time scale of electronic CD defines the time scale of gene translation and corresponds therefore to the standard value of  $\hbar_0$ . The findings about honeybees however support the view that  $k_{eff} > 205$  levels are present but are associated with the honeybee colony rather than individuals. This however requires that the these levels have neuronal realization in terms of Josephson frequencies.

Therefore a more precise formulation of the hypothesis about great leaps in evolution would be that great leaps in evolution correspond to the emergence of a new dark matter level at the level of individual organism. If this view is correct then  $k_{eff} > 205$  levels would correspond to a collective level of consciousness in the case of invertebrates down to bacteria, which are indeed found to form societies [I51]. This conforms also with the fact that the genome of invertebrates is

too small to allow realization of  $k_{eff} > 205$  flux sheets as genes or even super-genes. The somewhat unexpected conclusion would be that all activities of invertebrates involving gene expression would be controlled by collective levels of consciousness: invertebrates would not be individuals in this sense. Viruses do not possess DNA translation machinery which is consistent with the absence of also collective  $k_{eff} > 205$  levels. One can of course ask whether the queen of honeybee could be an exception to this rule.

If one believes that the time scale of gene expression corresponds to Josephson frequency then the explanation for the universality of the genetic code could be that  $k_{eff} > 205$  levels controls gene expression: for  $k_{eff} > 205$  wave length scale indeed corresponds to the length scale assignable to the magnetosphere of Earth. One could of course counter argue that it is more reasonable form magnetic Mother Gaia to delegate this kind of duties to the lower levels and that the CDs of electron and quarks are ideal for this purpose.

#### 8.4.4 Dark matter hierarchy, hierarchical structure of nervous system, and hierarchy of emotions

One can ask how the structural and functional hierarchy of CNS and the hierarchy of emotions relates to the dark matter hierarchy. The basic picture wherefrom one can start is following.

1. The emergence of nervous system corresponds to the emergence of  $k_{eff} < 205$  levels of dark matter hierarchy above  $k_{eff} < 167$ . For instance, worms and insects would correspond to this level.
2. Vertebrates have EEG and thus the most primitive vertebrates (reptiles) should correspond to  $k_{eff} \geq 205$ .
3. The emergence of new structures need not mean the emergence of new levels of dark matter hierarchy. Rather, the most reasonable criterion for the presence of these levels is the emergence of behaviors involving long term goals and the magnetic bodies of the parts of brain assignable to the control of this kind of behaviors would correspond to higher values of  $k_{eff}$ . Also the maximum span of memories at given level should be characterized by the value of  $k_{eff}$  associated with the brain structures involved (hippocampus, mammillary bodies). This picture conforms with the fact that already insects possess neurons, ganglia, and head containing the predecessor of cerebrum but correspond to  $k_{eff} \leq 205$  most naturally.

For goal related emotions the maximal time scale assignable to the achievement of the goal might allow to identify the time scale characterizing corresponding level of dark matter hierarchy. The lowest level emotions would be "primitive" emotions not related to any goal and one can as whether they could be assigned to organs consisting of ordinary cells and correspond to  $k_{eff} \leq 205$ .

1. The time scale of planned behavior and of long term memories makes possible to estimate upper bounds for the values of  $k_{eff}$  assuming Josephson frequency hypothesis.  $k_{eff} \leq 205$  would give the upper bound of 6 ms which corresponds to cerebellar resonance frequency 160 Hz. This time scale looks too short even for the simplest vertebrates and one must be very cautious here.
2. An alternative interpretation is as the shortest possible span for short term memory whose time scale is known to vary.
3. Cerebellar rhythm could be analogous to hippocampal theta rhythm and involved with the cerebellar memory storage and therefore would not tell anything about the span of the memory but would characterize the time resolution of memories and planned actions. The role of cerebellum in the fine coordination of motor actions indeed requires high time resolution.

Brain has anatomic division into midbrain, hindbrain, and forebrain [J2]. Midbrain and hindbrain (sometimes both are included in brain stem) is possessed by even the most primitive vertebrates and its emergence could therefore correspond to the emergence of  $k_{eff} \geq 205$  levels and EEG. The emergence of these levels relates naturally to the emergence of long term planning of motor actions in motor areas. The emergence of limbic brain, which defines the most primitive

forebrain, could mean the emergence of the Gaussian Mersenne defined by  $k_{eff} = 239$  containing dark electron condensates level and goal related emotions. This conforms with the fact that for mammals forebrain and cerebral hemispheres dominate whereas for other vertebrates hindbrain and cerebellum are in the dominant role.

### Reptilian brain as $k_{eff} \leq 205$ system?

Reptilian brain contains only the structures corresponding to brain stem (midbrain and hind brain, in particular cerebellum) and as far structures are considered would correspond to  $k_{eff} \leq 205$  levels of the hierarchy. Cerebellum is not believed to contribute directly to our consciousness. The absence of higher looks however an unrealistic assumption since reptiles certainly have long term memories.

Simplest emotions correspond to emotions involving no goal. Moods like excitement, feeling good/bad/tired/strong, etc.. could represent examples of such emotions and could be experienced already by reptilians. Of course, the scaled up variants of these emotions could appear at higher levels of hierarchy and would relate to the states of magnetic bodies (degree of the quantum coherence of Bose-Einstein condensates!).

### Limbic system

Limbic system is not possessed by reptiles [J5]. It is responsible for emotions, control of emotions, and also emotional intelligence. Limbic system corresponds to the brain of the most mammals. The limbic brain includes the amygdala, anterior thalamic nucleus, cingulate gyrus, fornix, hippocampus, hypothalamus, mammillary bodies, medial forebrain bundle, prefrontal lobes, septal nuclei, and other areas and pathways of the brain.

1. The sub-cortical part of the limbic system involves amygdalar and septal divisions. According to [J5] amygdalar division promotes feeding, food-search, angry, and defensive behaviors related to obtaining food. Septal division promotes sexual pleasure, genital swelling, grooming, courtship, and maternal behavior. These divisions are emotional mirror images of each other hand could correspond to  $205 < k_{eff} < 239$ .
2. The cortical part of the limbic system contains cingulate gyrus which is the newest part of the limbic system and belongs to thalamo-cingulate division which promotes play, vocalization (e.g., the separation cry), and maternal behavior. The time scale of memories would be shorter than 3.4 at this level.
3. Frontal lobes [J3] are often regarded as the organ of volition. The frontal lobes are involved in motor function, problem solving, spontaneity, memory, language, initiation, judgement, impulse control, and social and sexual behavior. Prefrontal lobes representing the extreme front part of frontal lobes belong also to the limbic system and are responsible for motivation and ability to pose long term goals. This ability distinguishes humans from other primates. For these reasons frontal lobes, in particular prefrontal lobes, could involve the highest levels of dark matter hierarchy in the case of humans. The Gaussian Mersenne levels  $k_{eff} = (239, 241)$  could be assigned as lowest level in this hierarchy. The time scale of long term memories would be longer than 3.4 years at these levels.

Cortico-striatal emotions like sadness, hate, fear anger, surprise, embarrassment, happiness, contentment, and joy involve goal structures and failure or success to achieve the goal in essential manner and would involve prefrontal lobes.

These levels would naturally relate to collective levels of consciousness coded by hyper genes. Hence these emotions could also relate to goals not directly related to the fate of biological body. Mirror neurons are a crucial prerequisite of a social behavior (autistic children seem to lack them), which suggests that hyper genes are involved at least with them.

Social emotions (feeling embarrassed, ashamed, guilty, loved, accepted, ...) could be induced by the collective levels of dark matter hierarchy as punishments or rewards for social behavior very much like neurotransmitters are believed to provide rewards and punishments at neuronal level.

### Neocortex and two kinds of intelligences

Neocortex is often assumed to be superior ("neomammalian") part of the brain and makes the majority of brain hemispheres. The species which are considered to be highly intelligent, such as humans and dolphins, tend to have large amounts of neocortex. The amount of neocortex is roughly proportional to the brain size for primates.

Neocortex cannot correspond to  $k_{eff} \geq 239$  (defining Gaussian Mersenne) as a whole. The decomposition of sensory areas to layers is consistent with the presence of lower levels since it is time resolution which matters in the case of sensory representations. Same conclusion applies to sensory association areas. The fine tuning of the motor control performed by cerebellum is consistent with  $k_{eff} \leq 205$ . Intelligence understood in the conventional sense of the word is accurate, works fast, and is computer like. The part of neocortex responsible for ordinary intelligence would be a rapid and accurate processor of sensory and cognitive representations. Hence  $k_{eff} < 239$  would naturally characterize sensory areas, secondary and primary motor areas, to hippocampal representation of declarative memories, and all association areas except dorsolateral prefrontal sensory-motor association cortex where short term memories are represented.

Emotional intelligence works slowly and is responsible for visions and holistic views and would thus correspond to higher levels of dark matter hierarchy. Limbic system is involved with emotions, motivation and long term planning and would thus be responsible for emotional intelligence. Indeed, the damage to frontal lobes [J3] need not affect ordinary intelligence but affects emotional intelligence.

### The levels of dark matter hierarchy associated with short and long term memory

The first thing to ask is of course whether the notions of short and long term memory make sense in TGD framework. Indeed, it would seem that it is more natural to speak about hierarchy of memories with characteristic time scales coming as selected powers of two.

1. According to [J7], the span of other than visual short term memories is 30-45 seconds. This requires  $k_{eff} \in \{217, 218\}$ .
2. Visual short term memories [J1] representing selected features of visual field are reported to have time span of few seconds. This suggests  $k_{eff} \in \{213, 214, 215\}$ .
3. Iconic visual memories representing entire visual field have much shorter time span of order 1 s:  $k_{eff} \in \{211, 212\}$  would be appropriate for them,
4. Long term memories would correspond to  $k_{eff} > 218$ .

Hippocampus and mammillary bodies involved with long term memory recall are part of the limbic system. The hippocampal theta rhythm 4-12 Hz, which could correspond roughly to  $k_{eff} \in \{163, 162, 161\}$  has nothing to do with the span of long term memories but would define the time resolution of the memories: the moment of sensory experience indeed corresponds to 10 Hz frequency. The frequencies responsible for memory storage need not have anything to do with the ultralow frequencies characterizing the temporal distance of the past event associated with the memory recall and hippocampus could just build a kind of bit sequence which during memory recall is communicated from the geometric past to some part of the future brain or magnetic body.

Anterograde amnesia means an inability to restore long term memories. The damage of hippocampus or of mammillary bodies can induce anterograde amnesia. In the usual conceptual framework the explanation would be the inability to store new long memories. In TGD framework this would be inability to construct those cognitive representations which are communicated to the geometric future in long term memory recall. Retrograde amnesia seems to involve almost always anterograde amnesia and means loss of memories for some time span before the injury. A possible explanation is that injury can propagate also to the geometric past of the brain quantum jump by quantum jump.

During ageing memories tend to be lost but the memories of childhood are the most stable ones. A possible interpretation is that faster rhythms of the generalized EEG tend to disappear: kind of scaled up variant for the process of falling into sleep accompanied by silencing of higher EEG bands could be in question.

### What about transpersonal levels of consciousness?

$k_{eff} > 245$  levels of dark matter hierarchy correspond to time span longer than 109 years and cannot relate to the biological body alone. They could relate to higher collective levels of the dark matter hierarchy and evolution of social structures. The memories extending over personal life span claimed by meditators could have interpretation in terms of  $k_{eff} > 245$  transpersonal levels of consciousness. Also the "god module" located to temporal lobes could correspond to this kind of levels of dark matter hierarchy. If it corresponds to Gaussian Mersenne with  $k_{eff} = 283$  the time scale of memories becomes huge: about  $10^{14}$  years so that the notion of "god module" is indeed appropriate.

## 8.5 How advanced civilization could study cosmos?

Space travel is not the best manner for the advanced civilization to study the surrounding cosmos. Rather, time mirror mechanism (see fig. <http://www.tgdtheory.fi/appfigures/timemirror.jpg> or fig. 24 in the appendix of this book) seems to provide almost unlimited opportunities to achieve this. Chilbolton (see Figs. 8.7 and 8.7) and Crabwoodcrop circles suggest that aliens could be either intra-terrestrial life forms or ourselves in a relatively remote geometric future. The TGD based new physics suggest also a natural solution to the Fermi paradox ("Where are they all?").

### 8.5.1 Why space travel is not a good idea?

There are several arguments suggesting that space-travel over very long distances is not a good idea.

1. Direct encounters of life forms, which are at different evolutionary level would be probably lethal since immune systems would not be compatible. Thus there is no good reason for long space-travels.
2. With the recent technology the amount of fuel needed makes it impossible to get very far. Remote utilization of energy by time mirror mechanism could resolve this difficulty. Many-sheeted population inverted lasers might be everywhere and provide the needed energy. TGD suggests mechanisms making it possible to reduce the inertial mass of the space-ship dramatically. This kind of feather light space-ships could behave as UFOs are found to behave.
3. The finite value of the light velocity poses the most severe constraints. Time dilatation in principle allows the space-ship moving with sufficiently high velocity to get to arbitrary long distances in arbitrarily short proper time experienced by the crew. The problem is however that the civilization that send the crew to the flight could suffer extinction during the first days (as experienced by travellers) of the travel. Note however that time mirror mechanism could allow to circumvent this difficulty.

### 8.5.2 Time mirror mechanism as an ideal tool for the study of the Universe

Time mirror mechanism suggest a solution to the problem of communicating with civilizations in distant galaxies and light velocity ceases to be problem. Remote sensing in principle makes possible an active instantaneous scanning of arbitrarily distance galaxies. Remote motor control is also possible and in principle makes it possible to use simple life forms like plasmoids to perform desired tasks. These plasmoids could serve also as quantum mediums making sharing of mental images possible. This would give rise to a remote sensory system.

Also communications with the civilizations of the geometric future could be possible. p-Adic frequencies coming as half octaves of the frequency 10 Hz are excellent candidates for preferred frequencies and one can assign to each of these p-adic frequencies hierarchy of cognitive codes that with definite duration of code word and number of bits. Field patterns realizing these code words could provide means of communication with civilizations of both geometric future and past. ET experiences might have interpretation as a sharing of mental images induced by encounters with

the plasmoids generated during the tectonic activity. Abduction experiences could represent real encounters with plasmoids.

Plasmoids could be seen an ideal realization for a living space-ship drawing its energy from environment. UFOs might be plasmoid structures emitted from the plasma sheet of some planet of a distant stellar system which have managed to penetrate through the cusp region of the magnetopause of Earth, which serves as a magneto-immune system preventing the penetration of solar and other interplanetary magnetic life forms inside magnetosphere. A civilization at sufficiently high level of development could even intentionally generate magnetic self-organization patterns leading to birth of plasmoid like life forms. The somewhat ghostly crew of a magneto-UFO could consist of magnetospheric sensory representations for the inhabitants of this planet but this would not diminish the reality of the experience. Space travel of mental images would not require transfer of huge amounts of fuel through cosmos and light velocity would not be a limitation for the communications. There are good reasons to believe that higher levels of the self hierarchy have discovered mental space travel long ago if even we have been able to invent it!

### 8.5.3 What aliens are?

The first possibility is that aliens are extraterrestrials. In this case one cannot say much more. If one takes crop circles as an attempt of aliens to tell something about their civilization one ends up with much more detailed speculations. Chilbolton and Crabwood crop formations are the most fascinating of these messages [H1, H2, H5, H7]. The Chilbolton and Crabwood crop circles allow to even deduce rather precise information about the genetic codes of the alien life forms, and the second genetic code involves 80 DNAs and 23 amino-acids. This would mean that the civilization in question might be at a much higher evolutionary level than we are, and could have developed antigravity technology for long time ago. I have discussed the interpretation of these formations in the [K20].

The fact that the Chilbolton message so soon after the sending of Arecibo message providing information about human kind as species and had same format as Arecibo message could mean that the constructor of the messages is inside or at least in the vicinity of solar system.

A plausible hypothesis is that the magnetosphere of Earth, or possibly also of Sun, defining kind of collective conscious entity having various biological life forms as its "cells", has generated the crop circles using the same basic mechanisms as magnetic bodies use to generate generalized motor actions in biological bodies. Magnetosphere could communicate its own higher level knowledge to us or could mediate a message from somewhere.

#### Do crop circles tell about solars or intra-planetary?

If the crop circles are generated by control signals based on positive energy topological light rays, the constructor of the message, and perhaps also the civilization about which the message tells, can be at most at a distance of few light decades. Indeed, Chilbolton message suggests that the aliens live at Earth, Mars and Jupiter and perhaps even in Sun. The Sun is smaller than in Arecibo message, which might mean that the aliens live in below the corona, perhaps at the magnetic flux tubes of the convective zone carrying magnetic fields of order .2 Tesla for which electronic cyclotron radiation is at micro-wave range. The question is where in Earth's magnetosphere aliens could be hiding. The Freudian answer is that since they are not visible they must lurk in the cellar, that is underground. One can indeed build a vision about alien life based on this idea and consistent with the hints provided by the crop formations.

#### Do crop circles tell about futuro-terrestrials?

If the crop circles are generated by communications involving negative energy photons (phase conjugate light) then the signals responsible for the formation of crop circles arrive from the geometric future. In this case the civilization could be arbitrary far away from Earth. Chilbolton message however leaves only the possibility that the civilization is some other civilization or ourselves of the geometric future after the colonization of Mars and Jupiter. This civilization must have invented the technology making it possible to apply time mirror mechanism to induce magnetic self-organization patterns leading to the generation of plasmoids serving as mediums for telepathic communications and able to perform simple tasks like construction of crop circles.



### How far in the geometric future futuro-terrestrials might live?

Chilbolton message could even allow to estimate how far in the geometric future the civilization constructing crop circles is located.

1. The smaller size of Sun could indeed mean a smaller size of Sun: standard model predicts that the radius increases very slowly so that this interpretation seems to be wrong in standard physics context. There are however highly controversial claims that Sun is shrinking with the rate of .1 per cent per century [E15] :  $d\log(R)/dt = 10^{-3}/\tau$ ,  $\tau = 100$  years. The analysis of [E23] however led to a conclusion that only oscillations with a period of 76 years are in question. If the shrinking occurred for the entire Sun rather than only surface layers, the claimed rate for shrinking would mean that gravitational energy would be liberated with a rate  $P = GM_{Sun}^2/R \times d\log(R)/dt$ , which would give  $P \sim 10^{29}$  Watts, which is much higher than the power  $P \sim 4 \times 10^{26}$  Watts radiated by Sun by known mechanisms.

The presence of the classical  $Z^0$  force could make possible considerable deviations from the standard stellar evolution and might be also needed to explain the oscillations of the solar radius. The increase of the gravitational binding energy could be compensated by the increase of the repulsive  $Z^0$  Coulomb energy so that the catastrophic conclusion could be avoided. One could say that gravitational and  $Z^0$  force serve opposite tendencies compensating each other in the "solar homeostasis".

If the shrinking were real and would continue with the rate claimed in [E15] , one would have  $R/R_{now} = \exp(-10^{-3}t/\tau)$ . If the radius in Chilbolton message is by a factor  $k < 1$  smaller than in Arecibo message, the proposed interpretation implies that the message must have been sent from a temporal distance  $t \simeq \log(1/k) \times 10^3\tau \sim 10^5$  years in the geometric future. A more realistic estimate would probably increase the value of  $t$  by some powers of 10. If this extremely light hearted argument were taken seriously, a breakthrough in time mirror technology is not to be expected during my lifetime!

2. There is also a second manner to estimate the value of temporal distance of crop circle artists from us. Crabwood formation appeared year and one day later than Chilbolton formation. A possible interpretation is as a message telling that the it takes one day more for Earth to rotate around Sun in the geometric future so that year is by one day longer.

i) The mass loss of Sun causes the gradual weakening of the gravitational force of Sun causing the increase of the radii of planetary orbits and thus also of orbital periods. The rate for the increase of the orbital period is  $d\log(T)/dt \equiv 1/\tau = -1/4 \times d\log(M_{Sun})/dt$ . The rate of the solar mass loss is believed to be mostly due to the energy liberated in fusion, and one has in a good approximation  $d\log(M)/dt = 10^{-13}/year$ . This gives  $T(t)/T(now) = \exp(t/\tau)$ . The lengthening of year by one day requires a time  $t \simeq \tau/365 \sim 10^{11}$  years, which is about one percent of the rough estimate for the lifetime of Sun, and of the same order of magnitude as the estimates for the time parameter called the recent age of the Universe. In fact, Sun is estimated to become a red giant within 7.5 billion years making life as we understand it impossible at Earth.

ii) Also cosmic expansion should affect the orbital radii of the planets. If the Hubble time  $t$  and radial coordinate  $r$  of Robertson-Walker cosmology with line element  $ds^2 = dt^2 - a(t)^2(dr^2/(1+r^2) + r^2d\Omega^2)$  correspond to the coordinates  $t_{PN}$  and  $r_{PN}$  of the Post-Newtonian approximation, and if cosmic expansion can be treated adiabatically, the prediction is that the sizes of the planetary orbits increase are scaled as  $L(a)/L(a_0) = a/a_0$ , where  $a$  corresponds to  $M_+^4$  light cone proper time appearing as the scaling factor of Robertson-Walker metric and related to the Hubble time  $t$  by  $(t/t_0) = (a/a_0)^{3/2}$ . By Kepler's law one has  $T \propto L^{3/2}$  so that the period of the planetary orbit would scale as  $T \propto a^{3/2} \propto t$ . One day per year lengthening would correspond to  $\Delta T/T = 1/365 = \Delta t/t$ . For  $t = 5 \times 10^9$  years this would give  $\Delta t = 17$  million years.

iii) The estimate above is based on the neglect of perturbations caused by planets to each other's orbits. The multiple gravitational resonances between planets resulting, when the ratios of rotation or precession periods are integer valued, are a route to chaos (in the sense of complexity rather than randomness) in the planetary system. Since also  $Z^0$  force is  $1/r^2$

force, this hold true also when classical  $Z^0$  force is taken into account. These resonances can affect dramatically orbital parameters. Numerical simulations lead to the conclusion that the Lyapunov time of planetary system is 5-10 million years [E28] . If this holds true also in TGD Universe, then the parameter  $t$  for the future civilization for which year is one day longer than for us, could be as small as million years. In any case it seems that it takes quite a time to develop time mirror technology if this estimate makes sense.

#### 8.5.4 Have more advanced civilizations performed genetic engineering at Earth?

A fascinating possibility that extraterrestrials, intra-terrestrials, or ourselves of the geometric future have performed genetic engineering. There is some support that this might be occurring.

1. The first sensational finding was the outcome of Great Genome Project. The "head-scratching discovery" by the public consortium, as Science termed it, came when the human genome was compared with the genomes of our predecessors [I21, I31]. It was found that human genome contains 223 genes not possessed by invertebrates. Contrary to what one might expect, these 223 genes could make an enormous difference. The reason is that this number is more than two thirds of the number of the 300 genes differentiating between humans and chimpanzees so that these genes could be the main determinant of the dramatic difference between humans and chimpanzees in standard genetics. A possible explanation is that this difference is due to a genetic engineering carried out by a more advanced civilization [K20] . This genetic engineering might have induced the migration of Homo Sapiens from Africa and an explosive evolution of language and culture.
2. The second sensational finding reported towards the end of the year 2003 was that the genome of corals, which are the simplest life forms possessing neurons, seems to resemble much more vertebrate genome than it resembles genomes of flies and worms [I29] . Corals resemble vertebrates in the sense that they have calcium carbonate skeleton. Corals are multicellular structures consisting of two cell layers analogous to scaled up versions of the lipid layers of cell membrane. Thus coral colonies can be seen as organisms for which the role of cell is taken by corals, and are in a very well special sense at a higher evolutionary level than us. The assumption that corals are intra-terrestrial or extraterrestrial life-forms which have served as gene banks radiating their genes to the simple life forms in environment could explain the mysterious Cambrian explosion in which a large number of animal phyla emerged apparently from nowhere [I32] . This speculative vision is discussed in [K31] .

Aliens are not the only candidates for genetic engineers. Also magnetic Mother Gaia could be responsible for the genetic engineering, even the magnetic Mother Gaia of the distance geometric future. There are experimental findings [J6] supporting that electromagnetic radiation can be imprinted by genetic information and that this genetic information can be transferred to the genome of developing embryos of even different species [K32] .

Nothing precludes the possibility that genes/supergenes/hyper genes at some level of dark matter hierarchy can also code for genetic self engineering since these activities are after all very similar to other genetically coded bio-chemical activities. The computer analogy would be programs writing programs. The engineering genes would be activated by  $W$  MEs inducing plasma oscillation patterns. The claimed effects could be understood if the interaction with genetically imprinted electromagnetic field pattern activates genes inducing genetic self engineering yielding the genetic modifications consistent with the pattern represented by the em radiation.

Magnetic body would receive information about the desired outcome as electromagnetic field patterns emitted by other organisms, most naturally members of the same species. If these modifications are successful, the magnetic body is exposed to this information for long enough time to react and activate  $W$  MEs inducing the genetic program inducing the genetic program leading to the suggested genetic modification.

Hyper-genes [K40] integrating groups of organisms to larger wholes would be naturally involved with the mechanism. This mechanism would guarantee a rapid propagation of successful genetic modifications to the entire population and would be much more effective than the slowly occurring

selection of random mutations. The possibly existing genes responsible for the genetic self engineering could be also introns and express themselves by activating nuclear RNA and process like reverse transcription.

### 8.5.5 Fermi paradox

The question "Where are they all?" is the best manner to formulate Fermi paradox. Fermi made estimates about the probability of intelligent life in Cosmos and ended up with the conclusion that intelligent civilizations should have already expressed their presence to us. There are many manners to achieve this.

1. The radiation generated by radio-wave communications leaks out to the interstellar space and should serve as a telltale signature about the presence of intelligence. The civilizations might be as willing as us to tell about the existence, and might send to the interstellar space radio-waves telling about them as a life form. We have indeed sent Arecibo message just in this purpose.

The communications based on Maxwellian radio waves might however represent a rather short period in the development of the civilization. Topological light rays allow precisely targeted communications without weakening and dispersion of the signal and since the signal propagates outside the space-time sheets containing matter, the perturbations caused by the interaction with matter are small. For this kind of communications the leakage of the signals is minimal, and the civilization remains invisible for civilizations which have not yet reached the technological maturity to receive and interpret signals travelling along topological light rays (possibly parallel to magnetic flux tube structures serving as cosmic nervous systems). This is the safest option since civilizations like us might be very dangerous in their eagerness to declare Star Wars.

2. One might argue that high tech civilizations are doomed to produce a lot of entropy and the radiation resulting in this manner could also serve as a telltale signature. The discovery of the technology based on time mirror mechanism would however mean dramatic reduction in the entropy production. Quite generally, the second law of thermodynamics can be circumvented below p-adic time scale so that also the mad consumer period could be short lasting.
3. The engineering achievements of these civilizations in astrophysical length scales might be one signature. It is however not at all clear whether we are able to see them. Presumably living technology relying on magnetic self-organization of super conducting magnetic flux tube structures serving as an astrophysical "nervous system" is in question. Magnetic flux tubes however quite literally represent dark matter [K17] to us and the established science has not yet even discovered the notion of magnetic body and is still trying to explain dark matter in terms of various X-ons.
4. Star wars thinking would suggest that the civilization evolved to a high level technologically would build space-ships and start the conquering of other planetary systems. Macroscopic quantum coherence of dark matter in astrophysical length scales however provides completely new methods of communication and control, and it is quite possible that the aliens are just patiently waiting that we finally discover that dark matter aliens are here, there, and everywhere. One might hope that this discovery does not require the emergence of the next level of dark matter hierarchy in the terrestrial biological evolution since it might not take place during this week.
5. These civilization hardly see the trouble of transferring tons of material to foreign stellar systems since time mirror mechanism allows telepathic communications by sharing of mental images with civilizations of both geometric future and past. The encounters with UFOs and ETs might be just this kind of virtual meetings but most terrestrial scientists take them as hallucinations. The explosive development of science could be due to the sharing of mental images of more developed civilization but it is difficult for us to even consider the possibility that we have not discovered all this by ourselves.

Time mirror mechanism could make even possible intentional induction of magnetic self-organization creating plasmoid like life forms. The reports about intelligent light balls appear repeatedly but most terrestrial scientists refuse to take seriously these reports. Crop circles might represent an extreme example about an attempt of advanced intelligence to get into a direct communication with us but most scientists receiving monthly salaries refuse to even play with the thought that these formations might not be hoaxes.

On basis of these arguments it seems that Fermi paradox tells much more about us than the surrounding universe. Our view about consciousness and life and physics is so badly wrong that it leads to the conclusions that consciousness is illusion, living beings are deterministic robots, and Earth is the only living planet in the entire Universe. We could test however test the TGD based vision. Perhaps some mad scientist starts some day to build population inverted lasers at energies corresponding to p-adic frequencies and zero point kinetic energy increments in order to receive negative energy signals from future, begins to send phase conjugate waves to the geometric past at these frequencies using p-adic cognitive codes (genetic code in particular, [K31] ), and starts to analyze carefully radio-wave patterns at the p-adic frequencies to see whether they contain some structure suggesting that the sender of the signal is intelligent.

### 8.5.6 Dark matter hierarchy as a solution of Fermi paradox?

The original version of this chapter was written few years before the ideas related to the quantization of Planck constant began to develop [K26] . The original stimulus came from the observation that the radii of the inner planets seem to correspond to the radii of Bohr orbits with a gigantic value of gravitational Planck constant  $h_{gr} = gMm/v_0$ ,  $v_0 \simeq 2^{-11}$ . The radii for the orbits of outer planets in turn correspond to  $v_0 \rightarrow v_0/5$  [E29] . The dependence of  $h_{gr}$  on masses is fixed by Equivalence Principle and  $v_0 = 2^{-11}$  corresponds in TGD framework to a fundamental constant expressible in terms of  $CP_2$  radius, Planck length, and Kähler coupling strength [K67] .

The general theory for the quantization of Planck constants [K26] predicts the spectrum of  $M_{\pm}^4$  and  $CP_2$  Planck constants as integer multiples  $\hbar(M_{\pm}^4) = n_a \hbar_0$  and  $\hbar(CP_2) = n_b \hbar_0$  of the ordinary Planck constant  $\hbar_0$ . The Planck constant  $\hbar_{eff}$  appearing in the Schrödinger equation using  $\hbar_0$  as a unit equals to the ratio  $n_a/n_b$  having in principle all positive rational values.

The spectrum of Planck constants reflects a hierarchy of imbedding spaces characterized by finite subgroups of  $SU(2)$  identified as a subgroup of  $SL(2,C)$  in the case of  $M_{\pm}^4$  Planck constant and of  $SU(3)$  in the case of  $CP_2$  Planck constant (appearing in the commutation relations of corresponding isometry Lie algebras). The subgroup  $G_b \subset SU(2) \subset SU(3)$  defines a covering of  $M_{\pm}^4$  by  $G_b$ -related points whereas the subgroup  $G_a \subset SU(2) \subset SL(2,C)$  defines covering of  $CP_2$  by  $G_a$ -related points. The covariant metric of  $M_{\pm}^4$  factor is scaled up by  $n_b^2$ , where  $n_b$  is the order of the maximal cyclic subgroup of  $G_b$ . Analogous result holds for  $CP_2$ .

These copies of imbedding spaces are glued together to a tree like structure such that  $M_{\pm}^4$  ( $CP_2$ ) are identified by isometry if  $G_b$  ( $G_a$ ) is same for the two copies. Each node involves infinitely many branches labelled by  $G_b$  ( $G_a$ ). One can say that two kind of matters in this hierarchy are dark with respect to each other if they reside at different branches of this structure. If  $G_a$  ( $G_b$ ) is same for the two sectors, a phase transition changing the value of Planck constant  $\hbar(CP_2)$  ( $\hbar(M_{\pm}^4)$ ) can occur and corresponds geometrically to a leakage been different sectors via an intermediate state which has 0-dimensional  $CP_2$  projection or 2-dimensional  $M_{\pm}^4$  projection (time like plane remaining invariant under  $G_a \subset SO(3)$ ) containing the quantization axis for angular momentum). The points in the projection correspond to singular orbifold points for the  $G$ -covering in question.

Also a spectrum of number theoretic values of Planck constants is predicted  $n_a$  and  $n_b$  correspond for them to n-polygons constructible using only ruler and compass. The resulting model for planetary orbits predicts that the ratios of planetary masses should be given as ratios  $q_{ab}/q_{cd}$  of ratios  $q_{ab} = n_a/n_b$  of these preferred integers. This is rather strong a prediction and satisfied within 3 per cent. Also an absolute prediction  $Gm/v_0 = n_a/n_b$  (say in the case of Earth-Sun pair) results and is wrong by about 4 per cent: the failure could be understood if the masses in question correspond to dark matter [K67] .

Particles mass spectrum does not depend on the values of Planck constants whereas Compton length scales as  $n_a$ . For large values of  $\hbar_{eff}$  the overlap criterion for the formation of macroscopic quantum phases is satisfied due to the large values of Compton lengths. In the case of gravitational Planck constant the macroscopic quantum phases would have an astrophysical size. Dark matter

hierarchy would correspond to a hierarchy of increasingly refined levels of consciousness with an increasing span of long term memory and planned action and utilizing the lower levels of hierarchy as sensory receptors and motor instruments.

In biology an especially important dark matter hierarchy seems to correspond to  $\hbar(M_{\pm}^4, k) = 2^{11k}$ ,  $\hbar(CP_2) = \hbar_0$  and great leaps in evolution could be understood as the emergence of a new level of this kind to the "personal" dark matter hierarchy realized as a hierarchy of magnetic bodies (topologically quantized magnetic fields associated with the system) [K22]. The group  $G_a$  would most naturally act as symmetry group of dark magnetic body transforming to each other the flux tubes of the magnetic body representing topological quantized dipole type magnetic field having a full rotational symmetry before topological quantization.  $n_a$  would give the number of flux tubes.

If one accepts the model for the hierarchy of EEGs, the duration of life cycle identified as a cyclotron time scale for a typical biologically important ion gives a reasonable guess for the highest level of dark matter hierarchy involved. For instance, from the requirement that EEG photons have energy above thermal energy, the time scale of ordinary EEG would correspond to  $n_a = 2^{11k}$ ,  $k = 4$ , and the duration of our life cycle to  $k = 7$ . In meditative states referred often to as cosmic consciousness the value of  $k$  might be much higher.

In this conceptual framework the answer to the question "Where are they?" would be based on the identification of "them" as conscious entities at higher levels of dark matter hierarchy and living at different branches of the imbedding space. If all goes well, civilization would sooner or later achieve Omega point at which it becomes so convinced about the existence of this hierarchy that it initiates systematic attempts to build communications with higher levels of the hierarchy and perhaps "moves" more or less permanently to this branch of imbedding space which would naturally explain Fermi paradox.

## 8.6 What UFOs are?

The second key question concerns the interpretation of UFOs. Interpretation as plasmoids might be equivalent with interpretation as living flying saucers able to reduce their inertial and gravitational mass and using time mirror mechanism (see fig. <http://www.tgdtheory.fi/appfigures/timemirror.jpg> or fig. 24 in the appendix of this book) to extract energy from environment.

### 8.6.1 UFOs as plasmoids?

One of the most important findings about UFOs is their butterfly like behavior. They can accelerate very rapidly and change their direction of motion instantaneously. Since this occurs without generation of shock waves, the only conclusion seems to be that their inertial and gravitational masses are very light.

Persinger has proposed a model explaining the experiences about encounters of extraterrestrials as hallucinations caused by the perturbations of Earth's magnetic field induced by the liberation of the tectonic energy at the lines of tectonic activity [J25]. The model is based on well-established statistics about the effects of the perturbations of Earth's magnetic field on consciousness collected in mental hospitals. The lines of the tectonic activity are also accompanied by well established luminous phenomena which suggests that the model could be naturally combined with the explanation of UFOs as this kind of luminous phenomena.

This suggests that UFOs might be plasmoids. These primitive life-forms could use time mirror mechanism to receive metabolic energy and tectonic activity would be excellent source of metabolic energy. Plasmoids, being extremely light structures, could easily follow the energy beam flowing from the spot of tectonic activity, and the random variation of the beam direction could explain the random butterfly like motion of UFOs often observed and very difficult to understand if UFOs are structures built of steel and copper. This identification does not of course mean that plasmoids could not be living, intelligent space-ships. The lightness and ability to draw energy from the environment would make plasmoids ideal for this purposed.

### 8.6.2 UFOs made of copper and steel?

There is some evidence for 'metallic' UFOs too. In particular, the claimed Roswell case involving a "traffic accident" of UFO and dead bodies of aliens suggests that aliens and UFOs are real. TGD based model [K78] for the strange antigravity effects observed in rotating magnetic systems [H49] leads to a mechanism which might be behind flying saucers. The basic idea is that the space-time sheet of rotating magnet is connected to the space-time sheet carrying Earth's gravitational field by join along boundaries bonds, one can visualize them as threads connecting the rotating system to the environment. Along these threads the gravitational flux created by the magnet flows to Earth's space-time sheet and these threads mediate the gravitational interaction.

Rotation causes the entanglement of the threads and when the rotational speed becomes high enough, the threads begin to split. This means that the ends of the split threads become carriers of negative and positive gravitational mass. Effectively the gravitational mass of the magnet system remains to the Earth's space-time sheet and the mass of magnet system itself decreases and angular momentum conservation implies an acceleration of the spinning motion (pirouette effect). If the inertial mass is equal to the gravitational mass as Equivalence Principle requires, a system which is light as a feather results!

This mechanism might make possible flying saucers. For instance, the rotating system could apply time mirror mechanism to generate the needed very fast motion making possibly mass loss. It could also accelerate and change direction of motion very quickly. The strange properties of UFOs suggest that if they are really flying saucers, a reduction of the inertial mass is indeed involved. Thus one might think of the possibility that plasmoid like structure and a more rigid structure accompany each other in some cases. The rotating magnet system involves also plasma near its outer boundary and would in this case be due to acceleration of ions in radial electric field generate by the rotating magnet. Plasmoid like structures indeed involve magnetic flux tubes and this suggests that they could rotate rapidly and in this manner reduce their gravitational and inertial mass.

### 8.6.3 Are flying saucers necessarily living systems?

The following arguments suggest that flying saucers are necessarily living systems.

1. As explained earlier, the study of field equations leads to the classification of basic phases of matter by the dimension  $D$  of  $CP_2$  projection of the space-time sheet.  $D = 2$  would naturally correspond to magnetic flux tube structure associated with non-rotating magnetic system. This phase is simple and analogous to a ferro-magnet. As already found by Faraday, a radial electric field accompanied by a non-vanishing vacuum charge density is generated when a constant magnetic field is put into rotation. The non-vanishing charge density requires a 3-dimensional  $CP_2$  projection. The conclusion is that rotation induces a phase transition  $D = 2 \rightarrow 3$ .
2. The phase transition implies a qualitative change in the structure of the magnetic fields and could thus explain the generation of magnetic walls observed in the rotating magnetic system [H49]. What is fascinating that  $D = 3$  phase corresponds to the living matter in the proposed classification. This would conform with the idea that the ADP-ATP machinery responsible for the metabolism is a molecular Searl machine. Hence the strange effects observed in rotating magnetic systems might reveal the fundamentals of the dead  $\rightarrow$  alive phase transition. Also this suggests that plasmoids could be seen as flying saucers which are living just because they are flying saucers.
3. The increase of the dimension of  $CP_2$  projection could generate join along boundaries contacts and wormhole contacts leading to the transfer of charge between different space-time sheets. The possibly resulting flow of gravitational flux to larger space-time sheets might help to explain the claimed antigravity effects.

## 8.7 Figures and illustrations

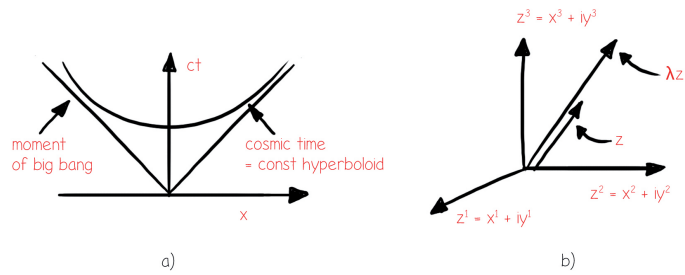

Figure 8.2: Space-times can be regarded as 4-dimensional surfaces in 8-dimensional space  $H = M_+^4 \times CP_2$  obtained by replacing points of future light cone of Minkowski space with  $CP_2$ .

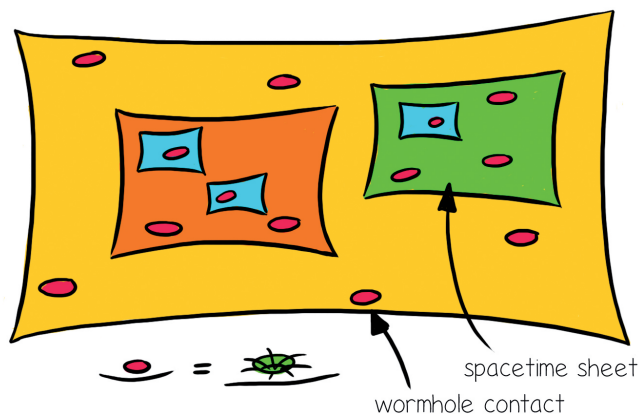

Figure 8.3: Material objects correspond to the sheets of the many-sheeted space-time. Note that sheets are extremely near to each other.

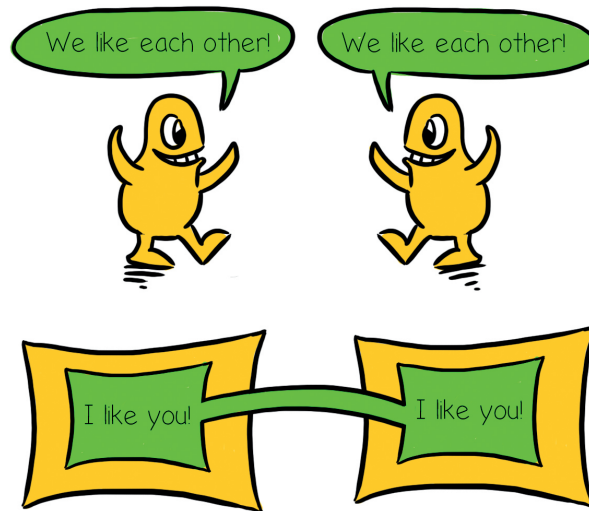

Figure 8.4: The space-time sheets condensed on larger space-time sheets having no join along boundaries bonds can be connected by join along boundaries bonds. This forces to generalize the notion of sub-system and makes possible sharing of mental images.

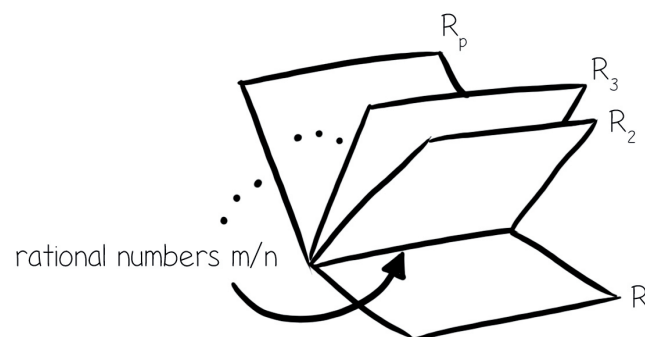

Figure 8.5: Generalization of the number concept: real and  $p$ -adic number fields correspond to the pages of book and the rim of book corresponds to rational numbers common to all of them.



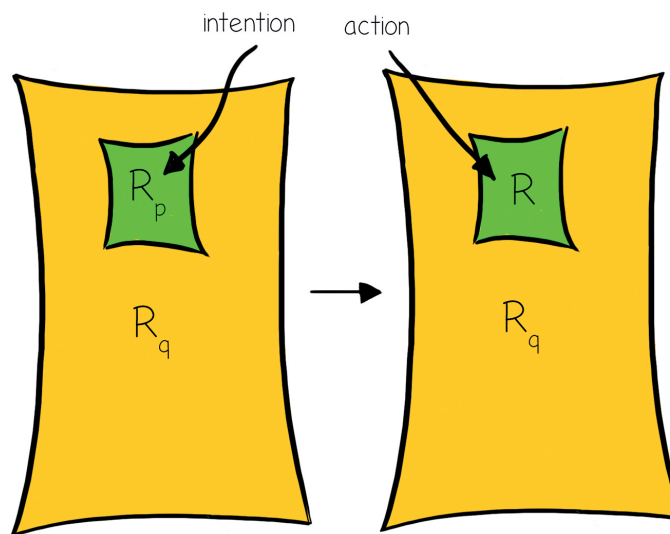

Figure 8.6: The transformation of p-adic space-time sheet to a real one in quantum jump correspond to the transformation of intention to action.

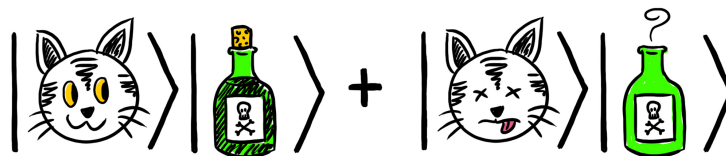

Figure 8.7: Quantum entangled systems lose their identify. Schrödinger cat entangled with the poison bottle is neither living nor dead or is both simultaneously.

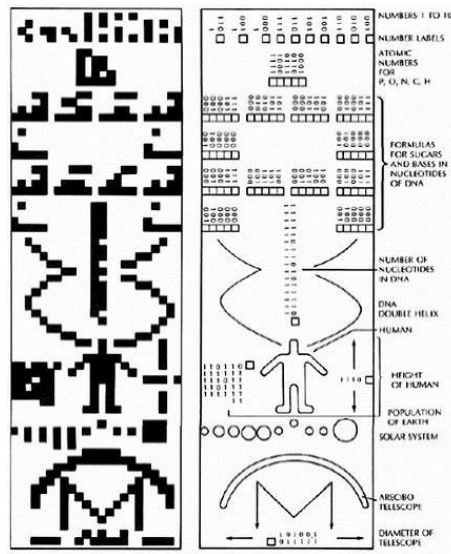

Figure 8.8: Arecibo message provides information about us.

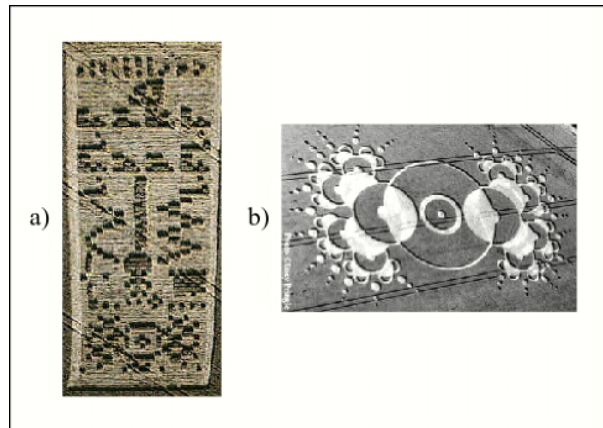

Figure 8.9: Chilbolton crop formation of figure a) is made using the same format as Arecibo message and can be interpreted as providing information about the constructors of the formation. Figure b) is the counterpart of radio antenna used to generate the message. A possible interpretation is as magnetosphere which suggests that the conscious entity responsible for the generation of crop circles is entity magnetosphere, brain of Mother Gaia.

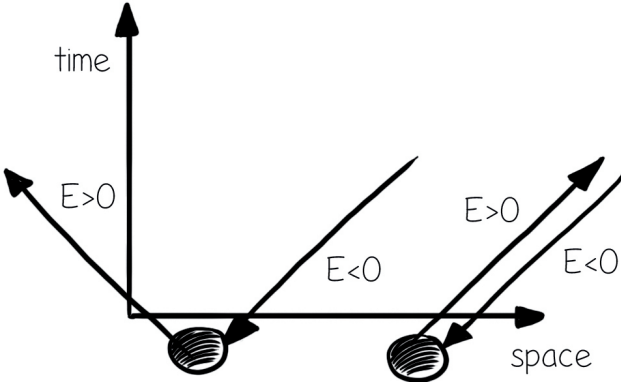

Figure 8.10: Time mirror mechanism

# Chapter 1

## Appendix

Originally this appendix was meant to be a purely technical summary of basic facts but in its recent form it tries to briefly summarize those basic visions about TGD which I dare to regard as stabilized. I have added illustrations making it easier to build mental images about what is involved and represented briefly the key arguments. This chapter is hoped to help the reader to get fast grasp about the concepts of TGD.

The basic properties of imbedding space and related spaces are discussed and the relationship of  $CP_2$  to standard model is summarized. The notions of induction of metric and spinor connection, and of spinor structure are discussed. Many-sheeted space-time and related notions such as topological field quantization and the relationship many-sheeted space-time to that of GRT space-time are discussed as well as the recent view about induced spinor fields and the emergence of fermionic strings. Various topics related to p-adic numbers are summarized with a brief definition of p-adic manifold and the idea about generalization of the number concept by gluing real and p-adic number fields to a larger book like structure. Hierarchy of Planck constants can be now understood in terms of the non-determinism of Kähler action and the recent vision about connections to other key ideas is summarized.

### A-1 Imbedding space $M^4 \times CP_2$ and related notions

Space-times are regarded as 4-surfaces in  $H = M^4 \times CP_2$  the Cartesian product of empty Minkowski space - the space-time of special relativity - and compact 4-D space  $CP_2$  with size scale of order  $10^4$  Planck lengths. One can say that imbedding space is obtained by replacing each point  $m$  of empty Minkowski space with 4-D tiny  $CP_2$ . The space-time of general relativity is replaced by a 4-D surface in  $H$  which has very complex topology. The notion of many-sheeted space-time gives an idea about what is involved.

Fig. 1. Imbedding space  $H = M^4 \times CP_2$  as Cartesian product of Minkowski space  $M^4$  and complex projective space  $CP_2$ . <http://www.tgdtheory.fi/appfigures/Hoo.jpg>

Denote by  $M_+^4$  and  $M_-^4$  the future and past directed lightcones of  $M^4$ . Denote their intersection, which is not unique, by CD. In zero energy ontology (ZEO) causal diamond (CD) is defined as cartesian product  $CD \times CP_2$ . Often I use CD to refer just to  $CD \times CP_2$  since  $CP_2$  factor is relevant from the point of view of ZEO.

Fig. 2. Future and past light-cones  $M_+^4$  and  $M_-^4$ . Causal diamonds (CD) are defined as their intersections. <http://www.tgdtheory.fi/appfigures/futurepast.jpg>

Fig. 3. Causal diamond (CD) is highly analogous to Penrose diagram but simpler. <http://www.tgdtheory.fi/appfigures/penrose.jpg>

A rather recent discovery was that  $CP_2$  is the only compact 4-manifold with Euclidian signature of metric allowing twistor space with Kähler structure.  $M^4$  is in turn is the only 4-D space with Minkowskian signature of metric allowing twistor space with Kähler structure so that  $H = M^4 \times CP_2$  is twistorially unique.

One can loosely say that quantum states in a given sector of "world of classical worlds" (WCW) are superpositions of space-time surfaces inside CDs and that positive and negative energy parts of zero energy states are localized and past and future boundaries of CDs. CDs form a hierarchy. One can have CDs within CDs and CDs can also overlap. The size of CD is characterized by the proper time distance between its two tips. One can perform both translations and also Lorentz boosts of CD leaving either boundary invariant. Therefore one can assign to CDs a moduli space and speak about wave function in this moduli space.

In number theoretic approach it is natural to restrict the allowed Lorentz boosts to some discrete subgroup of Lorentz group and also the distances between the tips of CDs to multiples of  $CP_2$  radius defined by the length of its geodesic. Therefore the moduli space of CDs discretizes. The quantization of cosmic recession velocities for which there are indications, could relate to this quantization.

## A-2 Basic facts about $CP_2$

$CP_2$  as a four-manifold is very special. The following arguments demonstrates that it codes for the symmetries of standard models via its isometries and holonomies.

### A-2.1 $CP_2$ as a manifold

$CP_2$ , the complex projective space of two complex dimensions, is obtained by identifying the points of complex 3-space  $C^3$  under the projective equivalence

$$(z^1, z^2, z^3) \equiv \lambda(z^1, z^2, z^3) . \quad (\text{A-2.1})$$

Here  $\lambda$  is any non-zero complex number. Note that  $CP_2$  can be also regarded as the coset space  $SU(3)/U(2)$ . The pair  $z^i/z^j$  for fixed  $j$  and  $z^i \neq 0$  defines a complex coordinate chart for  $CP_2$ . As  $j$  runs from 1 to 3 one obtains an atlas of three coordinate charts covering  $CP_2$ , the charts being holomorphically related to each other (e.g.  $CP_2$  is a complex manifold). The points  $z^3 \neq 0$  form a subset of  $CP_2$  homeomorphic to  $R^4$  and the points with  $z^3 = 0$  a set homeomorphic to  $S^2$ . Therefore  $CP_2$  is obtained by "adding the 2-sphere at infinity to  $R^4$ ".

Besides the standard complex coordinates  $\xi^i = z^i/z^3$ ,  $i = 1, 2$  the coordinates of Eguchi and Freund [A13] will be used and their relation to the complex coordinates is given by

$$\begin{aligned} \xi^1 &= z + it , \\ \xi^2 &= x + iy . \end{aligned} \quad (\text{A-2.2})$$

These are related to the "spherical coordinates" via the equations

$$\begin{aligned} \xi^1 &= r \exp(i \frac{(\Psi + \Phi)}{2}) \cos(\frac{\Theta}{2}) , \\ \xi^2 &= r \exp(i \frac{(\Psi - \Phi)}{2}) \sin(\frac{\Theta}{2}) . \end{aligned} \quad (\text{A-2.3})$$

The ranges of the variables  $r, \Theta, \Phi, \Psi$  are  $[0, \infty], [0, \pi], [0, 4\pi], [0, 2\pi]$  respectively.

Considered as a real four-manifold  $CP_2$  is compact and simply connected, with Euler number Euler number 3, Pontryagin number 3 and second  $b = 1$ .

Fig. 4.  $CP_2$  as manifold. <http://www.tgdtheory.fi/appfigures/cp2.jpg>

### A-2.2 Metric and Kähler structure of $CP_2$

In order to obtain a natural metric for  $CP_2$ , observe that  $CP_2$  can be thought of as a set of the orbits of the isometries  $z^i \rightarrow \exp(i\alpha)z^i$  on the sphere  $S^5$ :  $\sum z^i \bar{z}^i = R^2$ . The metric of  $CP_2$  is obtained by projecting the metric of  $S^5$  orthogonally to the orbits of the isometries. Therefore the distance between the points of  $CP_2$  is that between the representative orbits on  $S^5$ .

The line element has the following form in the complex coordinates

$$ds^2 = g_{a\bar{b}} d\xi^a d\bar{\xi}^b , \quad (\text{A-2.4})$$

where the Hermitian, in fact Kähler metric  $g_{a\bar{b}}$  is defined by

$$g_{a\bar{b}} = R^2 \partial_a \partial_{\bar{b}} K , \quad (\text{A-2.5})$$

where the function  $K$ , Kähler function, is defined as

$$\begin{aligned} K &= \log(F) , \\ F &= 1 + r^2 . \end{aligned} \quad (\text{A-2.6})$$

The Kähler function for  $S^2$  has the same form. It gives the  $S^2$  metric  $dzd\bar{z}/(1+r^2)^2$  related to its standard form in spherical coordinates by the coordinate transformation  $(r, \phi) = (\tan(\theta/2), \phi)$ .

The representation of the  $CP_2$  metric is deducible from  $S^5$  metric is obtained by putting the angle coordinate of a geodesic sphere constant in it and is given

$$\frac{ds^2}{R^2} = \frac{(dr^2 + r^2 \sigma_3^2)}{F^2} + \frac{r^2(\sigma_1^2 + \sigma_2^2)}{F} , \quad (\text{A-2.7})$$

where the quantities  $\sigma_i$  are defined as

$$\begin{aligned} r^2 \sigma_1 &= \text{Im}(\xi^1 d\xi^2 - \xi^2 d\xi^1) , \\ r^2 \sigma_2 &= -\text{Re}(\xi^1 d\xi^2 - \xi^2 d\xi^1) , \\ r^2 \sigma_3 &= -\text{Im}(\xi^1 d\bar{\xi}^1 + \xi^2 d\bar{\xi}^2) . \end{aligned} \quad (\text{A-2.8})$$

$R$  denotes the radius of the geodesic circle of  $CP_2$ . The vierbein forms, which satisfy the defining relation

$$s_{kl} = R^2 \sum_A e_k^A e_l^A , \quad (\text{A-2.9})$$

are given by

$$\begin{aligned} e^0 &= \frac{dr}{F} , & e^1 &= \frac{r\sigma_1}{\sqrt{F}} , \\ e^2 &= \frac{r\sigma_2}{\sqrt{F}} , & e^3 &= \frac{r\sigma_3}{F} . \end{aligned} \quad (\text{A-2.10})$$

The explicit representations of vierbein vectors are given by

$$\begin{aligned} e^0 &= \frac{dr}{F} , & e^1 &= \frac{r(\sin\Theta \cos\Psi d\Phi + \sin\Psi d\Theta)}{2\sqrt{F}} , \\ e^2 &= \frac{r(\sin\Theta \sin\Psi d\Phi - \cos\Psi d\Theta)}{2\sqrt{F}} , & e^3 &= \frac{r(d\Psi + \cos\Theta d\Phi)}{2F} . \end{aligned} \quad (\text{A-2.11})$$

The explicit representation of the line element is given by the expression

$$ds^2/R^2 = \frac{dr^2}{F^2} + \frac{r^2}{4F^2}(d\Psi + \cos\Theta d\Phi)^2 + \frac{r^2}{4F}(d\Theta^2 + \sin^2\Theta d\Phi^2) . \quad (\text{A-2.12})$$

The vierbein connection satisfying the defining relation

$$de^A = -V_B^A \wedge e^B , \quad (\text{A-2.13})$$

is given by

$$\begin{aligned} V_{01} &= -\frac{e^1}{r} , & V_{23} &= \frac{e^1}{r} , \\ V_{02} &= -\frac{e^2}{r} , & V_{31} &= \frac{e^2}{r} , \\ V_{03} &= (r - \frac{1}{r})e^3 , & V_{12} &= (2r + \frac{1}{r})e^3 . \end{aligned} \quad (\text{A-2.14})$$

The representation of the covariantly constant curvature tensor is given by

$$\begin{aligned} R_{01} &= e^0 \wedge e^1 - e^2 \wedge e^3 , & R_{23} &= e^0 \wedge e^1 - e^2 \wedge e^3 , \\ R_{02} &= e^0 \wedge e^2 - e^3 \wedge e^1 , & R_{31} &= -e^0 \wedge e^2 + e^3 \wedge e^1 , \\ R_{03} &= 4e^0 \wedge e^3 + 2e^1 \wedge e^2 , & R_{12} &= 2e^0 \wedge e^3 + 4e^1 \wedge e^2 . \end{aligned} \quad (\text{A-2.15})$$

Metric defines a real, covariantly constant, and therefore closed 2-form  $J$

$$J = -ig_{a\bar{b}}d\xi^a d\bar{\xi}^b , \quad (\text{A-2.16})$$

the so called Kähler form. Kähler form  $J$  defines in  $CP_2$  a symplectic structure because it satisfies the condition

$$J_r^k J^{rl} = -s^{kl} . \quad (\text{A-2.17})$$

The form  $J$  is integer valued and by its covariant constancy satisfies free Maxwell equations. Hence it can be regarded as a curvature form of a  $U(1)$  gauge potential  $B$  carrying a magnetic charge of unit  $1/2g$  ( $g$  denotes the gauge coupling). Locally one has therefore

$$J = dB , \quad (\text{A-2.18})$$

where  $B$  is the so called Kähler potential, which is not defined globally since  $J$  describes homological magnetic monopole.

It should be noticed that the magnetic flux of  $J$  through a 2-surface in  $CP_2$  is proportional to its homology equivalence class, which is integer valued. The explicit representations of  $J$  and  $B$  are given by

$$\begin{aligned} B &= 2re^3 , \\ J &= 2(e^0 \wedge e^3 + e^1 \wedge e^2) = \frac{r}{F^2} dr \wedge (d\Psi + \cos\Theta d\Phi) + \frac{r^2}{2F} \sin\Theta d\Theta d\Phi . \end{aligned} \quad (\text{A-2.19})$$

The vierbein curvature form and Kähler form are covariantly constant and have in the complex coordinates only components of type (1,1).

Useful coordinates for  $CP_2$  are the so called canonical coordinates in which Kähler potential and Kähler form have very simple expressions

$$\begin{aligned}
B &= \sum_{k=1,2} P_k dQ_k , \\
J &= \sum_{k=1,2} dP_k \wedge dQ_k .
\end{aligned} \tag{A-2.20}$$

The relationship of the canonical coordinates to the "spherical" coordinates is given by the equations

$$\begin{aligned}
P_1 &= -\frac{1}{1+r^2} , \\
P_2 &= \frac{r^2 \cos \Theta}{2(1+r^2)} , \\
Q_1 &= \Psi , \\
Q_2 &= \Phi .
\end{aligned} \tag{A-2.21}$$

### A-2.3 Spinors in $CP_2$

$CP_2$  doesn't allow spinor structure in the conventional sense [A10] . However, the coupling of the spinors to a half odd multiple of the Kähler potential leads to a respectable spinor structure. Because the delicacies associated with the spinor structure of  $CP_2$  play a fundamental role in TGD, the arguments of Hawking are repeated here.

To see how the space can fail to have an ordinary spinor structure consider the parallel transport of the vierbein in a simply connected space  $M$ . The parallel propagation around a closed curve with a base point  $x$  leads to a rotated vierbein at  $x$ :  $e^A = R_B^A e^B$  and one can associate to each closed path an element of  $SO(4)$ .

Consider now a one-parameter family of closed curves  $\gamma(v) : v \in (0, 1)$  with the same base point  $x$  and  $\gamma(0)$  and  $\gamma(1)$  trivial paths. Clearly these paths define a sphere  $S^2$  in  $M$  and the element  $R_B^A(v)$  defines a closed path in  $SO(4)$ . When the sphere  $S^2$  is contractible to a point e.g., homologically trivial, the path in  $SO(4)$  is also contractible to a point and therefore represents a trivial element of the homotopy group  $\Pi_1(SO(4)) = Z_2$ .

For a homologically nontrivial 2-surface  $S^2$  the associated path in  $SO(4)$  can be homotopically nontrivial and therefore corresponds to a nonclosed path in the covering group  $Spin(4)$  (leading from the matrix 1 to -1 in the matrix representation). Assume this is the case.

Assume now that the space allows spinor structure. Then one can parallel propagate also spinors and by the above construction associate a closed path of  $Spin(4)$  to the surface  $S^2$ . Now, however this path corresponds to a lift of the corresponding  $SO(4)$  path and cannot be closed. Thus one ends up with a contradiction.

From the preceding argument it is clear that one could compensate the non-allowed  $-1$ - factor associated with the parallel transport of the spinor around the sphere  $S^2$  by coupling it to a gauge potential in such a way that in the parallel transport the gauge potential introduces a compensating  $-1$ -factor. For a  $U(1)$  gauge potential this factor is given by the exponential  $\exp(i2\Phi)$  , where  $\Phi$  is the magnetic flux through the surface. This factor has the value  $-1$  provided the  $U(1)$  potential carries half odd multiple of Dirac charge  $1/2g$ . In case of  $CP_2$  the required gauge potential is half odd multiple of the Kähler potential  $B$  defined previously. In the case of  $M^4 \times CP_2$  one can in addition couple the spinor components with different chiralities independently to an odd multiple of  $B/2$ .

### A-2.4 Geodesic sub-manifolds of $CP_2$

Geodesic sub-manifolds are defined as sub-manifolds having common geodesic lines with the imbedding space. As a consequence the second fundamental form of the geodesic manifold vanishes, which means that the tangent vectors  $h_\alpha^k$  (understood as vectors of  $H$ ) are covariantly constant quantities with respect to the covariant derivative taking into account that the tangent vectors are vectors both with respect to  $H$  and  $X^4$ .



In [A6] a general characterization of the geodesic sub-manifolds for an arbitrary symmetric space  $G/H$  is given. Geodesic sub-manifolds are in 1-1-correspondence with the so called Lie triple systems of the Lie-algebra  $g$  of the group  $G$ . The Lie triple system  $t$  is defined as a subspace of  $g$  characterized by the closedness property with respect to double commutation

$$[X, [Y, Z]] \in t \text{ for } X, Y, Z \in t . \quad (\text{A-2.22})$$

$SU(3)$  allows, besides geodesic lines, two nonequivalent (not isometry related) geodesic spheres. This is understood by observing that  $SU(3)$  allows two nonequivalent  $SU(2)$  algebras corresponding to subgroups  $SO(3)$  (orthogonal  $3 \times 3$  matrices) and the usual isospin group  $SU(2)$ . By taking any subset of two generators from these algebras, one obtains a Lie triple system and by exponentiating this system, one obtains a 2-dimensional geodesic sub-manifold of  $CP_2$ .

Standard representatives for the geodesic spheres of  $CP_2$  are given by the equations

$$S_I^2 : \xi^1 = \bar{\xi}^2 \text{ or equivalently } (\Theta = \pi/2, \Psi = 0) ,$$

$$S_{II}^2 : \xi^1 = \xi^2 \text{ or equivalently } (\Theta = \pi/2, \Phi = 0) .$$

The non-equivalence of these sub-manifolds is clear from the fact that isometries act as holomorphic transformations in  $CP_2$ . The vanishing of the second fundamental form is also easy to verify. The first geodesic manifold is homologically trivial: in fact, the induced Kähler form vanishes identically for  $S_I^2$ .  $S_{II}^2$  is homologically nontrivial and the flux of the Kähler form gives its homology equivalence class.

## A-3 $CP_2$ geometry and standard model symmetries

### A-3.1 Identification of the electro-weak couplings

The delicacies of the spinor structure of  $CP_2$  make it a unique candidate for space  $S$ . First, the coupling of the spinors to the  $U(1)$  gauge potential defined by the Kähler structure provides the missing  $U(1)$  factor in the gauge group. Secondly, it is possible to couple different  $H$ -chiralities independently to a half odd multiple of the Kähler potential. Thus the hopes of obtaining a correct spectrum for the electromagnetic charge are considerable. In the following it will be demonstrated that the couplings of the induced spinor connection are indeed those of the GWS model [B2] and in particular that the right handed neutrinos decouple completely from the electro-weak interactions.

To begin with, recall that the space  $H$  allows to define three different chiralities for spinors. Spinors with fixed  $H$ -chirality  $e = \pm 1$ ,  $CP_2$ -chirality  $l, r$  and  $M^4$ -chirality  $L, R$  are defined by the condition

$$\begin{aligned} \Gamma\Psi &= e\Psi , \\ e &= \pm 1 , \end{aligned} \quad (\text{A-3.1})$$

where  $\Gamma$  denotes the matrix  $\Gamma_9 = \gamma_5 \times \gamma_5$ ,  $1 \times \gamma_5$  and  $\gamma_5 \times 1$  respectively. Clearly, for a fixed  $H$ -chirality  $CP_2$ - and  $M^4$ -chiralities are correlated.

The spinors with  $H$ -chirality  $e = \pm 1$  can be identified as quark and lepton like spinors respectively. The separate conservation of baryon and lepton numbers can be understood as a consequence of generalized chiral invariance if this identification is accepted. For the spinors with a definite  $H$ -chirality one can identify the vielbein group of  $CP_2$  as the electro-weak group:  $SO(4) = SU(2)_L \times SU(2)_R$ .

The covariant derivatives are defined by the spinorial connection

$$A = V + \frac{B}{2}(n_+ 1_+ + n_- 1_-) . \quad (\text{A-3.2})$$

Here  $V$  and  $B$  denote the projections of the vielbein and Kähler gauge potentials respectively and  $1_{+(-)}$  projects to the spinor  $H$ -chirality  $+(-)$ . The integers  $n_{\pm}$  are odd from the requirement of a respectable spinor structure.

The explicit representation of the vielbein connection  $V$  and of  $B$  are given by the equations

$$\begin{aligned} V_{01} &= -\frac{e^1}{r} , & V_{23} &= \frac{e^1}{r_2} , \\ V_{02} &= -\frac{e^2}{r} , & V_{31} &= \frac{e^2}{r} , \\ V_{03} &= (r - \frac{1}{r})e^3 , & V_{12} &= (2r + \frac{1}{r})e^3 , \end{aligned} \quad (\text{A-3.3})$$

and

$$B = 2re^3 , \quad (\text{A-3.4})$$

respectively. The explicit representation of the vielbein is not needed here.

Let us first show that the charged part of the spinor connection couples purely left handedly. Identifying  $\Sigma_3^0$  and  $\Sigma_2^1$  as the diagonal (neutral) Lie-algebra generators of  $SO(4)$ , one finds that the charged part of the spinor connection is given by

$$A_{ch} = 2V_{23}I_L^1 + 2V_{13}I_L^2 , \quad (\text{A-3.5})$$

where one have defined

$$\begin{aligned} I_L^1 &= \frac{(\Sigma_{01} - \Sigma_{23})}{2} , \\ I_L^2 &= \frac{(\Sigma_{02} - \Sigma_{13})}{2} . \end{aligned} \quad (\text{A-3.6})$$

$A_{ch}$  is clearly left handed so that one can perform the identification

$$W^{\pm} = \frac{2(e^1 \pm ie^2)}{r} , \quad (\text{A-3.7})$$

where  $W^{\pm}$  denotes the charged intermediate vector boson.

Consider next the identification of the neutral gauge bosons  $\gamma$  and  $Z^0$  as appropriate linear combinations of the two functionally independent quantities

$$\begin{aligned} X &= re^3 , \\ Y &= \frac{e^3}{r} , \end{aligned} \quad (\text{A-3.8})$$

appearing in the neutral part of the spinor connection. We show first that the mere requirement that photon couples vectorially implies the basic coupling structure of the GWS model leaving only the value of Weinberg angle undetermined.

To begin with let us define

$$\begin{aligned} \bar{\gamma} &= aX + bY , \\ \bar{Z}^0 &= cX + dY , \end{aligned} \quad (\text{A-3.9})$$

where the normalization condition

$$ad - bc = 1 ,$$

is satisfied. The physical fields  $\gamma$  and  $Z^0$  are related to  $\bar{\gamma}$  and  $\bar{Z}^0$  by simple normalization factors.

Expressing the neutral part of the spinor connection in term of these fields one obtains

$$\begin{aligned}
A_{nc} &= [(c+d)2\Sigma_{03} + (2d-c)2\Sigma_{12} + d(n_+1_+ + n_-1_-)]\bar{\gamma} \\
&+ [(a-b)2\Sigma_{03} + (a-2b)2\Sigma_{12} - b(n_+1_+ + n_-1_-)]\bar{Z}^0 .
\end{aligned} \tag{A-3.10}$$

Identifying  $\Sigma_{12}$  and  $\Sigma_{03} = 1 \times \gamma_5 \Sigma_{12}$  as vectorial and axial Lie-algebra generators, respectively, the requirement that  $\gamma$  couples vectorially leads to the condition

$$c = -d . \tag{A-3.11}$$

Using this result plus previous equations, one obtains for the neutral part of the connection the expression

$$A_{nc} = \gamma Q_{em} + Z^0 (I_L^3 - \sin^2 \theta_W Q_{em}) . \tag{A-3.12}$$

Here the electromagnetic charge  $Q_{em}$  and the weak isospin are defined by

$$\begin{aligned}
Q_{em} &= \Sigma^{12} + \frac{(n_+1_+ + n_-1_-)}{6} , \\
I_L^3 &= \frac{(\Sigma^{12} - \Sigma^{03})}{2} .
\end{aligned} \tag{A-3.13}$$

The fields  $\gamma$  and  $Z^0$  are defined via the relations

$$\begin{aligned}
\gamma &= 6d\bar{\gamma} = \frac{6}{(a+b)}(aX + bY) , \\
Z^0 &= 4(a+b)\bar{Z}^0 = 4(X - Y) .
\end{aligned} \tag{A-3.14}$$

The value of the Weinberg angle is given by

$$\sin^2 \theta_W = \frac{3b}{2(a+b)} , \tag{A-3.15}$$

and is not fixed completely. Observe that right handed neutrinos decouple completely from the electro-weak interactions.

The determination of the value of Weinberg angle is a dynamical problem. The angle is completely fixed once the YM action is fixed by requiring that action contains no cross term of type  $\gamma Z^0$ . Pure symmetry non-broken electro-weak YM action leads to a definite value for the Weinberg angle. One can however add a symmetry breaking term proportional to Kähler action and this changes the value of the Weinberg angle.

To evaluate the value of the Weinberg angle one can express the neutral part  $F_{nc}$  of the induced gauge field as

$$F_{nc} = 2R_{03}\Sigma^{03} + 2R_{12}\Sigma^{12} + J(n_+1_+ + n_-1_-) , \tag{A-3.16}$$

where one has

$$\begin{aligned}
R_{03} &= 2(2e^0 \wedge e^3 + e^1 \wedge e^2) , \\
R_{12} &= 2(e^0 \wedge e^3 + 2e^1 \wedge e^2) , \\
J &= 2(e^0 \wedge e^3 + e^1 \wedge e^2) ,
\end{aligned} \tag{A-3.17}$$

in terms of the fields  $\gamma$  and  $Z^0$  (photon and  $Z$ - boson)

$$F_{nc} = \gamma Q_{em} + Z^0(I_L^3 - \sin^2\theta_W Q_{em}) . \quad (\text{A-3.18})$$

Evaluating the expressions above one obtains for  $\gamma$  and  $Z^0$  the expressions

$$\begin{aligned} \gamma &= 3J - \sin^2\theta_W R_{03} , \\ Z^0 &= 2R_{03} . \end{aligned} \quad (\text{A-3.19})$$

For the Kähler field one obtains

$$J = \frac{1}{3}(\gamma + \sin^2\theta_W Z^0) . \quad (\text{A-3.20})$$

Expressing the neutral part of the symmetry broken YM action

$$\begin{aligned} L_{ew} &= L_{sym} + f J^{\alpha\beta} J_{\alpha\beta} , \\ L_{sym} &= \frac{1}{4g^2} \text{Tr}(F^{\alpha\beta} F_{\alpha\beta}) , \end{aligned} \quad (\text{A-3.21})$$

where the trace is taken in spinor representation, in terms of  $\gamma$  and  $Z^0$  one obtains for the coefficient  $X$  of the  $\gamma Z^0$  cross term (this coefficient must vanish) the expression

$$\begin{aligned} X &= -\frac{K}{2g^2} + \frac{fp}{18} , \\ K &= \text{Tr} [Q_{em}(I_L^3 - \sin^2\theta_W Q_{em})] , \end{aligned} \quad (\text{A-3.22})$$

In the general case the value of the coefficient  $K$  is given by

$$K = \sum_i \left[ -\frac{(18 + 2n_i^2)\sin^2\theta_W}{9} \right] , \quad (\text{A-3.23})$$

where the sum is over the spinor chiralities, which appear as elementary fermions and  $n_i$  is the integer describing the coupling of the spinor field to the Kähler potential. The cross term vanishes provided the value of the Weinberg angle is given by

$$\sin^2\theta_W = \frac{9 \sum_i 1}{(fg^2 + 2 \sum_i (18 + n_i^2))} . \quad (\text{A-3.24})$$

In the scenario where both leptons and quarks are elementary fermions the value of the Weinberg angle is given by

$$\sin^2\theta_W = \frac{9}{(\frac{fg^2}{2} + 28)} . \quad (\text{A-3.25})$$

The bare value of the Weinberg angle is  $9/28$  in this scenario, which is quite close to the typical value  $9/24$  of GUTs [B5] .

### A-3.2 Discrete symmetries

The treatment of discrete symmetries C, P, and T is based on the following requirements:

1. Symmetries must be realized as purely geometric transformations.
2. Transformation properties of the field variables should be essentially the same as in the conventional quantum field theories [B1] .

The action of the reflection  $P$  on spinors of is given by

$$\Psi \rightarrow P\Psi = \gamma^0 \otimes \gamma^0 \Psi . \quad (\text{A-3.26})$$

in the representation of the gamma matrices for which  $\gamma^0$  is diagonal. It should be noticed that  $W$  and  $Z^0$  bosons break parity symmetry as they should since their charge matrices do not commute with the matrix of  $P$ .

The guess that a complex conjugation in  $CP_2$  is associated with T transformation of the physicist turns out to be correct. One can verify by a direct calculation that pure Dirac action is invariant under T realized according to

$$\begin{aligned} m^k &\rightarrow T(M^k) , \\ \xi^k &\rightarrow \bar{\xi}^k , \\ \Psi &\rightarrow \gamma^1 \gamma^3 \otimes 1 \Psi . \end{aligned} \quad (\text{A-3.27})$$

The operation bearing closest resemblance to the ordinary charge conjugation corresponds geometrically to complex conjugation in  $CP_2$ :

$$\begin{aligned} \xi^k &\rightarrow \bar{\xi}^k , \\ \Psi &\rightarrow \Psi^\dagger \gamma^2 \gamma^0 \otimes 1 . \end{aligned} \quad (\text{A-3.28})$$

As one might have expected symmetries CP and T are exact symmetries of the pure Dirac action.

## A-4 The relationship of TGD to QFT and string models

TGD could be seen as a generalization of quantum field theory (string models) obtained by replacing pointlike particles (strings) as fundamental objects with 3-surfaces.

Fig. 5. TGD replaces point-like particles with 3-surfaces. <http://www.tgdtheory.fi/appfigures/particletgd.jpg>

The fact that light-like 3-surfaces are effectively metrically 2-dimensional and thus possess generalization of 2-dimensional conformal symmetries with light-like radial coordinate defining the analog of second complex coordinate suggests that this generalization could work and extend the super-conformal symmetries to their 4-D analogs.

The boundary  $\delta M_+^4 = S^2 \times R_+$  of 4-D light-cone  $M_+^4$  is also metrically 2-dimensional and allows extended conformal invariance. Also the group of isometries of light-cone boundary and of light-like 3-surfaces is infinite-dimensional since the conformal scalings of  $S^2$  can be compensated by  $S^2$ -local scaling of the light-like radial coordinate of  $R_+$ . These simple facts mean that 4-dimensional Minkowski space and 4-dimensional space-time surfaces are in completely unique position as far as symmetries are considered.

String like objects obtained as deformations of cosmic strings  $X^2 \times Y^2$ , where  $X^2$  is minimal surface in  $M^4$  and  $Y^2$  a holomorphic surface of  $CP_2$  are fundamental extremals of Kähler action having string world sheet as  $M^4$  projections. Cosmic strings dominate the primordial cosmology of TGD Universe and inflationary period corresponds to the transition to radiation dominated cosmology for which space-time sheets with 4-D  $M^4$  projection dominate.

Also genuine string like objects emerge from TGD. The conditions that the em charge of modes of induces spinor fields is well-defined requires in the generic case the localization of the modes

at 2-D surfaces -string world sheets and possibly also partonic 2-surfaces. This in Minkowskian space-time regions.

Fig. 6. Well-definedness of em charge forces the localization of induced spinor modes to 2-D surfaces in generic situation in Minkowskian regions of space-time surface. <http://www.tgdtheory.fi/appfigures/fermistring.jpg>

TGD based view about elementary particles has two aspects.

1. The space-time correlates of elementary particles are identified as pairs of wormhole contacts with Euclidian signature of metric and having 4-D  $CP_2$  projection. Their throats behave effectively as Kähler magnetic monopoles so that wormhole throats must be connected by Kähler magnetic flux tubes with monopole flux so that closed flux tubes are obtained.
2. Fermion number is carried by the modes of the induced spinor field. In Minkowskian space-time regions the modes are localized at string world sheets connecting the wormhole contacts.

Fig. 7. TGD view about elementary particles. a) Particle corresponds 4-D generalization of world line or b) with its light-like 3-D boundary (holography). c) Particle world lines have Euclidian signature of the induced metric. d) They can be identified as wormhole contacts. e) The throats of wormhole contacts carry effective Kähler magnetic charges so that wormhole contacts must appear as pairs in order to obtain closed flux tubes. f) Wormhole contacts are accompanied by fermionic strings connecting the throats at same sheet: the strings do not extend inside the wormhole contacts. <http://www.tgdtheory.fi/appfigures/elparticletgd.jpg>

Particle interactions involve both stringy and QFT aspects.

1. The boundaries of string world sheets correspond to fundamental fermions. This gives rise to massless propagator lines in generalized Feynman diagrammatics. One can speak of "long" string connecting wormhole contacts and having hadronic string as physical counterpart. Long strings should be distinguished from wormhole contacts which due to their superconformal invariance behave like "short" strings with length scale given by  $CP_2$  size, which is  $10^4$  times longer than Planck scale characterizing strings in string models.
2. Wormhole contact defines basic stringy interaction vertex for fermion-fermion scattering. The propagator is essentially the inverse of the superconformal scaling generator  $L_0$ . Wormhole contacts containing fermion and antifermion at its opposite throats behave like virtual bosons so that one has BFF type vertices typically.
3. In topological sense one has 3-vertices serving as generalizations of 3-vertices of Feynman diagrams. In these vertices 4-D "lines" of generalized Feynman diagrams meet along their 3-D ends. One obtains also the analogs of stringy diagrams but stringy vertices do not have the usual interpretation in terms of particle decays but in terms of propagation of particle along two different routes.

Fig. 8. a) TGD analogs of Feynman and string diagrammatics at the level of space-time topology. b) The 4-D analogs of both string diagrams and QFT diagrams appear but the interpretation of the analogs stringy diagrams is different. <http://www.tgdtheory.fi/appfigures/tgdgraphs.jpg>

## A-5 Induction procedure and many-sheeted space-time

Since the classical gauge fields are closely related in TGD framework, it is not possible to have space-time sheets carrying only single kind of gauge field. For instance, em fields are accompanied by  $Z^0$  fields for extremals of Kähler action.

Classical em fields are always accompanied by  $Z^0$  field and some components of color gauge field. For extremals having homologically non-trivial sphere as a  $CP_2$  projection em and  $Z^0$  fields are the only non-vanishing electroweak gauge fields. For homologically trivial sphere only  $W$  fields are non-vanishing. Color rotations does not affect the situation.

For vacuum extremals all electro-weak gauge fields are in general non-vanishing although the net gauge field has U(1) holonomy by 2-dimensionality of the  $CP_2$  projection. Color gauge field

has  $U(1)$  holonomy for all space-time surfaces and quantum classical correspondence suggest a weak form of color confinement meaning that physical states correspond to color neutral members of color multiplets.

### Induction procedure for gauge fields

Induction procedure for gauge potentials and spinor structure is a standard procedure of bundle theory. If one has imbedding of some manifold to the base space of a bundle, the bundle structure can be induced so that it has as base space the imbedded manifold. In the recent case the imbedding of space-time surface to imbedding space defines the induction procedure. The induced gauge potentials and gauge fields are projections of the spinor connection of the imbedding space to the space-time surface. Induction procedure makes sense also for the spinor fields of imbedding space and one obtains geometrization of both electroweak gauge potentials and of spinors.

Fig. 9. Induction of spinor connection and metric as projection to the space-time surface. <http://www.tgdtheory.fi/appfigures/induct.jpg>

### Induced gauge fields for space-times for which $CP_2$ projection is a geodesic sphere

If one requires that space-time surface is an extremal of Kähler action and has a 2-dimensional  $CP_2$  projection, only vacuum extremals and space-time surfaces for which  $CP_2$  projection is a geodesic sphere, are allowed. Homologically non-trivial geodesic sphere correspond to vanishing  $W$  fields and homologically non-trivial sphere to non-vanishing  $W$  fields but vanishing  $\gamma$  and  $Z^0$ . This can be verified by explicit examples.

$r = \infty$  surface gives rise to a homologically non-trivial geodesic sphere for which  $e_0$  and  $e_3$  vanish imply the vanishing of  $W$  field. For space-time sheets for which  $CP_2$  projection is  $r = \infty$  homologically non-trivial geodesic sphere of  $CP_2$  one has

$$\gamma = \left( \frac{3}{4} - \frac{\sin^2(\theta_W)}{2} \right) Z^0 \simeq \frac{5Z^0}{8} .$$

The induced  $W$  fields vanish in this case and they vanish also for all geodesic sphere obtained by  $SU(3)$  rotation.

$Im(\xi^1) = Im(\xi^2) = 0$  corresponds to homologically trivial geodesic sphere. A more general representative is obtained by using for the phase angles of standard complex  $CP_2$  coordinates constant values. In this case  $e^1$  and  $e^3$  vanish so that the induced  $e_m$ ,  $Z^0$ , and Kähler fields vanish but induced  $W$  fields are non-vanishing. This holds also for surfaces obtained by color rotation. Hence one can say that for non-vacuum extremals with 2-D  $CP_2$  projection color rotations and weak symmetries commute.

### A-5.1 Many-sheeted space-time

TGD space-time is many-sheeted: in other words, there are in general several space-sheets which have projection to the same  $M^4$  region. Second manner to say this is that  $CP_2$  coordinates are many-valued functions of  $M^4$  coordinates. The original physical interpretation of many-sheeted space-time was not correct: it was assumed that single sheet corresponds to GRT space-time and this obviously leads to difficulties since the induced gauge fields are expressible in terms of only four imbedding space coordinates.

Fig. 10. Illustration of many-sheeted space-time of TGD. <http://www.tgdtheory.fi/appfigures/manysheeted.jpg>

### Superposition of effects instead of superposition of fields

The first objection against TGD is that superposition is not possible for induced gauge fields and induced metric. The resolution of the problem is that it is effects which need to superpose, not the fields.

Test particle topologically condenses simultaneously to all space-time sheets having a projection to same region of  $M^4$  (that is touches them). The superposition of effects of fields at various space-time sheets replaces the superposition of fields. This is crucial for the understanding also how GRT space-time relates to TGD space-time, which is also in the appendix of this book).

### Wormhole contacts

Wormhole contacts are key element of many-sheeted space-time. One does not expect them to be stable unless there is non-trivial Kähler magnetic flux flowing through them so that the throats look like Kähler magnetic monopoles.

Fig. 11. Wormhole contact. <http://www.tgdtheory.fi/appfigures/wormholecontact.jpg>

Since the flow lines of Kähler magnetic field must be closed this requires the presence of another wormhole contact so that one obtains closed monopole flux tube decomposing to two Minkowskian pieces at the two space-time sheets involved and two wormhole contacts with Euclidian signature of the induced metric. These objects are identified as space-time correlates of elementary particles and are clearly analogous to string like objects.

### The relationship between the many-sheeted space-time of TGD and of GRT space-time

The space-time of general relativity is single-sheeted and there is no need to regard it as surface in  $H$  although the assumption about representability as vacuum extremal gives very powerful constraints in cosmology and astrophysics and might make sense in simple situations.

The space-time of GRT can be regarded as a long length scale approximation obtained by lumping together the sheets of the many-sheeted space-time to a region of  $M^4$  and providing it with an effective metric obtained as sum of  $M^4$  metric and deviations of the induced metrics of various space-time sheets from  $M^4$  metric. Also induced gauge potentials sum up in the similar manner so that also the gauge fields of gauge theories would not be fundamental fields.

Fig. 12. The superposition of fields is replaced with the superposition of their effects in many-sheeted space-time. <http://www.tgdtheory.fi/appfigures/fieldsuperpose.jpg>

Space-time surfaces of TGD are considerably simpler objects than the space-times of general relativity and relate to GRT space-time like elementary particles to systems of condensed matter physics. Same can be said about fields since all fields are expressible in terms of imbedding space coordinates and their gradients, and general coordinate invariance means that the number of bosonic field degrees is reduced locally to 4. TGD space-time can be said to be a microscopic description whereas GRT space-time a macroscopic description. In TGD complexity of space-time topology replaces the complexity due to large number of fields in quantum field theory.

### Topological field quantization and the notion of magnetic body

Topological field quantization also TGD from Maxwell's theory. TGD predicts topological light rays ("massless extremals (MEs)) as space-time sheets carrying waves or arbitrary shape propagating with maximal signal velocity in single direction only and analogous to laser beams and carrying light-like gauge currents in the general case. There are also magnetic flux quanta and electric flux quanta. The deformations of cosmic strings with 2-D string orbit as  $M^4$  projection gives rise to magnetic flux tubes carrying monopole flux made possible by  $CP_2$  topology allowing homological Kähler magnetic monopoles.

Fig. 13. Topological quantization for magnetic fields replaces magnetic fields with bundles of them defining flux tubes as topological field quanta. <http://www.tgdtheory.fi/appfigures/field.jpg>

The imbeddability condition for say magnetic field means that the region containing constant magnetic field splits into flux quanta, say tubes and sheets carrying constant magnetic field. Unless one assumes a separate boundary term in Kähler action, boundaries in the usual sense are forbidden except as ends of space-time surfaces at the boundaries of causal diamonds. One obtains typically pairs of sheets glued together along their boundaries giving rise to flux tubes with closed cross section possibly carrying monopole flux.

These kind of flux tubes might make possible magnetic fields in cosmic scales already during primordial period of cosmology since no currents are needed to generate these magnetic fields: cosmic string would be indeed this kind of objects and would be dominated during the primordial period. Even superconductors and maybe even ferromagnets could involve this kind of monopole flux tubes.



## A-5.2 Imbedding space spinors and induced spinors

One can geometrize also fermionic degrees of freedom by inducing the spinor structure of  $M^4 \times CP_2$ .

$CP_2$  does not allow spinor structure in the ordinary sense but one can couple the opposite  $H$ -chiralities of  $H$ -spinors to an  $n = 1$  ( $n = 3$ ) integer multiple of Kähler gauge potential to obtain a respectable modified spinor structure. The em charges of resulting spinors are fractional (integer valued) and the interpretation as quarks (leptons) makes sense since the couplings to the induced spinor connection having interpretation in terms electro-weak gauge potential are identical to those assumed in standard model.

The notion of quark color differs from that of standard model.

1. Spinors do not couple to color gauge potential although the identification of color gauge potential as projection of  $SU(3)$  Killing vector fields is possible. This coupling must emerge only at the effective gauge theory limit of TGD.
2. Spinor harmonics of imbedding space correspond to triality  $t = 1$  ( $t = 0$ ) partial waves. The detailed correspondence between color and electroweak quantum numbers is however not correct as such and the interpretation of spinor harmonics of imbedding space is as representations for ground states of super-conformal representations. The wormhole pairs associated with physical quarks and leptons must carry also neutrino pair to neutralize weak quantum numbers above the length scale of flux tube (weak scale or Compton length). The total color quantum numbers of these states must be those of standard model. For instance, the color quantum numbers of fundamental left-hand neutrino and lepton can compensate each other for the physical lepton. For fundamental quark-lepton pair they could sum up to those of physical quark.

The well-definedness of em charge is crucial condition.

1. Although the imbedding space spinor connection carries  $W$  gauge potentials one can say that the imbedding space spinor modes have well-defined em charge. One expects that this is true for induced spinor fields inside wormhole contacts with 4-D  $CP_2$  projection and Euclidian signature of the induced metric.
2. The situation is not the same for the modes of induced spinor fields inside Minkowskian region and one must require that the  $CP_2$  projection of the regions carrying induced spinor field is such that the induced  $W$  fields and above weak scale also the induced  $Z^0$  fields vanish in order to avoid large parity breaking effects. This condition forces the  $CP_2$  projection to be 2-dimensional. For a generic Minkowskian space-time region this is achieved only if the spinor modes are localized at 2-D surfaces of space-time surface - string world sheets and possibly also partonic 2-surfaces.
3. Also the Kähler-Dirac gamma matrices appearing in the modified Dirac equation must vanish in the directions normal to the 2-D surface in order that Kähler-Dirac equation can be satisfied. This does not seem plausible for space-time regions with 4-D  $CP_2$  projection.
4. One can thus say that strings emerge from TGD in Minkowskian space-time regions. In particular, elementary particles are accompanied by a pair of fermionic strings at the opposite space-time sheets and connecting wormhole contacts. Quite generally, fundamental fermions would propagate at the boundaries of string world sheets as massless particles and wormhole contacts would define the stringy vertices of generalized Feynman diagrams. One obtains geometrized diagrammatics, which brings looks like a combination of stringy and Feynman diagrammatics.
5. This is what happens in the the generic situation. Cosmic strings could serve as examples about surfaces with 2-D  $CP_2$  projection and carrying only em fields and allowing delocalization of spinor modes to the entire space-time surfaces.

### A-5.3 Space-time surfaces with vanishing em, $Z^0$ , or Kähler fields

In the following the induced gauge fields are studied for general space-time surface without assuming the extremal property. In fact, extremal property reduces the study to the study of vacuum extremals and surfaces having geodesic sphere as a  $CP_2$  projection and in this sense the following arguments are somewhat obsolete in their generality.

#### Space-times with vanishing em, $Z^0$ , or Kähler fields

The following considerations apply to a more general situation in which the homologically trivial geodesic sphere and extremal property are not assumed. It must be emphasized that this case is possible in TGD framework only for a vanishing Kähler field.

Using spherical coordinates  $(r, \Theta, \Psi, \Phi)$  for  $CP_2$ , the expression of Kähler form reads as

$$\begin{aligned} J &= \frac{r}{F^2} dr \wedge (d\Psi + \cos(\Theta)d\Phi) + \frac{r^2}{2F} \sin(\Theta)d\Theta \wedge d\Phi , \\ F &= 1 + r^2 . \end{aligned} \tag{A-5.1}$$

The general expression of electromagnetic field reads as

$$\begin{aligned} F_{em} &= (3 + 2p) \frac{r}{F^2} dr \wedge (d\Psi + \cos(\Theta)d\Phi) + (3 + p) \frac{r^2}{2F} \sin(\Theta)d\Theta \wedge d\Phi , \\ p &= \sin^2(\Theta_W) , \end{aligned} \tag{A-5.2}$$

where  $\Theta_W$  denotes Weinberg angle.

1. The vanishing of the electromagnetic fields is guaranteed, when the conditions

$$\begin{aligned} \Psi &= k\Phi , \\ (3 + 2p) \frac{1}{r^2 F} (d(r^2)/d\Theta)(k + \cos(\Theta)) + (3 + p) \sin(\Theta) &= 0 , \end{aligned} \tag{A-5.3}$$

hold true. The conditions imply that  $CP_2$  projection of the electromagnetically neutral space-time is 2-dimensional. Solving the differential equation one obtains

$$\begin{aligned} r &= \sqrt{\frac{X}{1-X}} , \\ X &= D \left[ \frac{|k+u|}{C} \right]^\epsilon , \\ u &\equiv \cos(\Theta) , \quad C = k + \cos(\Theta_0) , \quad D = \frac{r_0^2}{1+r_0^2} , \quad \epsilon = \frac{3+p}{3+2p} , \end{aligned} \tag{A-5.4}$$

where  $C$  and  $D$  are integration constants.  $0 \leq X \leq 1$  is required by the reality of  $r$ .  $r = 0$  would correspond to  $X = 0$  giving  $u = -k$  achieved only for  $|k| \leq 1$  and  $r = \infty$  to  $X = 1$  giving  $|u+k| = [(1+r_0^2)/r_0^2]^{(3+2p)/(3+p)}$  achieved only for

$$\text{sign}(u+k) \times \left[ \frac{1+r_0^2}{r_0^2} \right]^{\frac{3+2p}{3+p}} \leq k+1 ,$$

where  $\text{sign}(x)$  denotes the sign of  $x$ .

The expressions for Kähler form and  $Z^0$  field are given by

$$\begin{aligned}
J &= -\frac{p}{3+2p} X du \wedge d\Phi , \\
Z^0 &= -\frac{6}{p} J .
\end{aligned} \tag{A-5.5}$$

The components of the electromagnetic field generated by varying vacuum parameters are proportional to the components of the Kähler field: in particular, the magnetic field is parallel to the Kähler magnetic field. The generation of a long range  $Z^0$  vacuum field is a purely TGD based feature not encountered in the standard gauge theories.

2. The vanishing of  $Z^0$  fields is achieved by the replacement of the parameter  $\epsilon$  with  $\epsilon = 1/2$  as becomes clear by considering the condition stating that  $Z^0$  field vanishes identically. Also the relationship  $F_{em} = 3J = -\frac{3}{4} \frac{r^2}{F} du \wedge d\Phi$  is useful.
3. The vanishing Kähler field corresponds to  $\epsilon = 1, p = 0$  in the formula for em neutral space-times. In this case classical em and  $Z^0$  fields are proportional to each other:

$$\begin{aligned}
Z^0 &= 2e^0 \wedge e^3 = \frac{r}{F^2} (k+u) \frac{\partial r}{\partial u} du \wedge d\Phi = (k+u) du \wedge d\Phi , \\
r &= \sqrt{\frac{X}{1-X}} , \quad X = D|k+u| , \\
\gamma &= -\frac{p}{2} Z^0 .
\end{aligned} \tag{A-5.6}$$

For a vanishing value of Weinberg angle ( $p = 0$ ) em field vanishes and only  $Z^0$  field remains as a long range gauge field. Vacuum extremals for which long range  $Z^0$  field vanishes but em field is non-vanishing are not possible.

### The effective form of $CP_2$ metric for surfaces with 2-dimensional $CP_2$ projection

The effective form of the  $CP_2$  metric for a space-time having vanishing em,  $Z^0$ , or Kähler field is of practical value in the case of vacuum extremals and is given by

$$\begin{aligned}
ds_{eff}^2 &= (s_{rr} \left(\frac{dr}{d\Theta}\right)^2 + s_{\Theta\Theta}) d\Theta^2 + (s_{\Phi\Phi} + 2ks_{\Phi\Psi}) d\Phi^2 = \frac{R^2}{4} [s_{\Theta\Theta}^{eff} d\Theta^2 + s_{\Phi\Phi}^{eff} d\Phi^2] , \\
s_{\Theta\Theta}^{eff} &= X \times \left[ \frac{\epsilon^2(1-u^2)}{(k+u)^2} \times \frac{1}{1-X} + 1 - X \right] , \\
s_{\Phi\Phi}^{eff} &= X \times [(1-X)(k+u)^2 + 1 - u^2] ,
\end{aligned} \tag{A-5.7}$$

and is useful in the construction of vacuum imbedding of, say Schwarzschild metric.

### Topological quantum numbers

Space-times for which either em,  $Z^0$ , or Kähler field vanishes decompose into regions characterized by six vacuum parameters: two of these quantum numbers ( $\omega_1$  and  $\omega_2$ ) are frequency type parameters, two ( $k_1$  and  $k_2$ ) are wave vector like quantum numbers, two of the quantum numbers ( $n_1$  and  $n_2$ ) are integers. The parameters  $\omega_i$  and  $n_i$  will be referred as electric and magnetic quantum numbers. The existence of these quantum numbers is not a feature of these solutions alone but represents a much more general phenomenon differentiating in a clear cut manner between TGD and Maxwell's electrodynamics.

The simplest manner to avoid surface Kähler charges and discontinuities or infinities in the derivatives of  $CP_2$  coordinates on the common boundary of two neighboring regions with different vacuum quantum numbers is topological field quantization, 3-space decomposes into disjoint topological field quanta, 3-surfaces having outer boundaries with possibly macroscopic size.

Under rather general conditions the coordinates  $\Psi$  and  $\Phi$  can be written in the form

$$\begin{aligned} \Psi &= \omega_2 m^0 + k_2 m^3 + n_2 \phi + \text{Fourier expansion} \ , \\ \Phi &= \omega_1 m^0 + k_1 m^3 + n_1 \phi + \text{Fourier expansion} \ . \end{aligned} \tag{A-5.8}$$

$m^0, m^3$  and  $\phi$  denote the coordinate variables of the cylindrical  $M^4$  coordinates) so that one has  $k = \omega_2/\omega_1 = n_2/n_1 = k_2/k_1$ . The regions of the space-time surface with given values of the vacuum parameters  $\omega_i, k_i$  and  $n_i$  and  $m$  and  $C$  are bounded by the surfaces at which space-time surface becomes ill-defined, say by  $r > 0$  or  $r < \infty$  surfaces.

The space-time surface decomposes into regions characterized by different values of the vacuum parameters  $r_0$  and  $\Theta_0$ . At  $r = \infty$  surfaces  $n_2, \omega_2$  and  $m$  can change since all values of  $\Psi$  correspond to the same point of  $CP_2$ : at  $r = 0$  surfaces also  $n_1$  and  $\omega_1$  can change since all values of  $\Phi$  correspond to same point of  $CP_2$ , too. If  $r = 0$  or  $r = \infty$  is not in the allowed range space-time surface develops a boundary.

This implies what might be called topological quantization since in general it is not possible to find a smooth global imbedding for, say a constant magnetic field. Although global imbedding exists it decomposes into regions with different values of the vacuum parameters and the coordinate  $u$  in general possesses discontinuous derivative at  $r = 0$  and  $r = \infty$  surfaces. A possible manner to avoid edges of space-time is to allow field quantization so that 3-space (and field) decomposes into disjoint quanta, which can be regarded as structurally stable units a 3-space (and of the gauge field). This doesn't exclude partial join along boundaries for neighboring field quanta provided some additional conditions guaranteeing the absence of edges are satisfied.

For instance, the vanishing of the electromagnetic fields implies that the condition

$$\Omega \equiv \frac{\omega_2}{n_2} - \frac{\omega_1}{n_1} = 0 \ , \tag{A-5.9}$$

is satisfied. In particular, the ratio  $\omega_2/\omega_1$  is rational number for the electromagnetically neutral regions of space-time surface. The change of the parameter  $n_1$  and  $n_2$  ( $\omega_1$  and  $\omega_2$ ) in general generates magnetic field and therefore these integers will be referred to as magnetic (electric) quantum numbers.

## A-6 p-Adic numbers and TGD

### A-6.1 p-Adic number fields

p-Adic numbers ( $p$  is prime: 2,3,5,...) can be regarded as a completion of the rational numbers using a norm, which is different from the ordinary norm of real numbers [A2] . p-Adic numbers are representable as power expansion of the prime number  $p$  of form

$$x = \sum_{k \geq k_0} x(k) p^k, \quad x(k) = 0, \dots, p-1 \ . \tag{A-6.1}$$

The norm of a p-adic number is given by

$$|x| = p^{-k_0(x)} \ . \tag{A-6.2}$$

Here  $k_0(x)$  is the lowest power in the expansion of the p-adic number. The norm differs drastically from the norm of the ordinary real numbers since it depends on the lowest binary digit of the p-adic number only. Arbitrarily high powers in the expansion are possible since the norm of the p-adic number is finite also for numbers, which are infinite with respect to the ordinary norm. A convenient representation for p-adic numbers is in the form

$$x = p^{k_0} \varepsilon(x) \ , \tag{A-6.3}$$

where  $\varepsilon(x) = k + \dots$  with  $0 < k < p$ , is p-adic number with unit norm and analogous to the phase factor  $\exp(i\phi)$  of a complex number.

The distance function  $d(x, y) = |x - y|_p$  defined by the p-adic norm possesses a very general property called ultra-metricity:

$$d(x, z) \leq \max\{d(x, y), d(y, z)\} . \quad (\text{A-6.4})$$

The properties of the distance function make it possible to decompose  $R_p$  into a union of disjoint sets using the criterion that  $x$  and  $y$  belong to same class if the distance between  $x$  and  $y$  satisfies the condition

$$d(x, y) \leq D . \quad (\text{A-6.5})$$

This division of the metric space into classes has following properties:

1. Distances between the members of two different classes  $X$  and  $Y$  do not depend on the choice of points  $x$  and  $y$  inside classes. One can therefore speak about distance function between classes.
2. Distances of points  $x$  and  $y$  inside single class are smaller than distances between different classes.
3. Classes form a hierarchical tree.

Notice that the concept of the ultra-metricity emerged in physics from the models for spin glasses and is believed to have also applications in biology [B4] . The emergence of p-adic topology as the topology of the effective space-time would make ultra-metricity property basic feature of physics.

## A-6.2 Canonical correspondence between p-adic and real numbers

The basic challenge encountered by p-adic physicist is how to map the predictions of the p-adic physics to real numbers. p-Adic probabilities provide a basic example in this respect. Identification via common rationals and canonical identification and its variants have turned out to play a key role in this respect.

### Basic form of canonical identification

There exists a natural continuous map  $I : R_p \rightarrow R_+$  from p-adic numbers to non-negative real numbers given by the "pinary" expansion of the real number for  $x \in R$  and  $y \in R_p$  this correspondence reads

$$\begin{aligned} y &= \sum_{k > N} y_k p^k \rightarrow x = \sum_{k < N} y_k p^{-k} , \\ y_k &\in \{0, 1, \dots, p-1\} . \end{aligned} \quad (\text{A-6.6})$$

This map is continuous as one easily finds out. There is however a little difficulty associated with the definition of the inverse map since the pinary expansion like also decimal expansion is not unique ( $1 = 0.999\dots$ ) for the real numbers  $x$ , which allow pinary expansion with finite number of pinary digits

$$\begin{aligned} x &= \sum_{k=N_0}^N x_k p^{-k} , \\ x &= \sum_{k=N_0}^{N-1} x_k p^{-k} + (x_N - 1)p^{-N} + (p-1)p^{-N-1} \sum_{k=0, \dots} p^{-k} . \end{aligned} \quad (\text{A-6.7})$$

The p-adic images associated with these expansions are different

$$\begin{aligned}
 y_1 &= \sum_{k=N_0}^N x_k p^k \ , \\
 y_2 &= \sum_{k=N_0}^{N-1} x_k p^k + (x_N - 1)p^N + (p - 1)p^{N+1} \sum_{k=0, \dots} p^k \\
 &= y_1 + (x_N - 1)p^N - p^{N+1} \ ,
 \end{aligned}
 \tag{A-6.8}$$

so that the inverse map is either two-valued for p-adic numbers having expansion with finite pinary digits or single valued and discontinuous and non-surjective if one makes pinary expansion unique by choosing the one with finite pinary digits. The finite pinary digit expansion is a natural choice since in the numerical work one always must use a pinary cutoff on the real axis.

**The topology induced by canonical identification**

The topology induced by the canonical identification in the set of positive real numbers differs from the ordinary topology. The difference is easily understood by interpreting the p-adic norm as a norm in the set of the real numbers. The norm is constant in each interval  $[p^k, p^{k+1})$  (see Fig. ??) and is equal to the usual real norm at the points  $x = p^k$ : the usual linear norm is replaced with a piecewise constant norm. This means that p-adic topology is coarser than the usual real topology and the higher the value of  $p$  is, the coarser the resulting topology is above a given length scale. This hierarchical ordering of the p-adic topologies will be a central feature as far as the proposed applications of the p-adic numbers are considered.

Ordinary continuity implies p-adic continuity since the norm induced from the p-adic topology is rougher than the ordinary norm. p-Adic continuity implies ordinary continuity from right as is clear already from the properties of the p-adic norm (the graph of the norm is indeed continuous from right). This feature is one clear signature of the p-adic topology.

Fig. 14. The real norm induced by canonical identification from 2-adic norm. <http://www.tgdtheory.fi/appfigures/norm.png>

The linear structure of the p-adic numbers induces a corresponding structure in the set of the non-negative real numbers and p-adic linearity in general differs from the ordinary concept of linearity. For example, p-adic sum is equal to real sum only provided the summands have no common pinary digits. Furthermore, the condition  $x +_p y < \max\{x, y\}$  holds in general for the p-adic sum of the real numbers. p-Adic multiplication is equivalent with the ordinary multiplication only provided that either of the members of the product is power of  $p$ . Moreover one has  $x \times_p y < x \times y$  in general. The p-Adic negative  $-1_p$  associated with p-adic unit 1 is given by  $(-1)_p = \sum_k (p - 1)p^k$  and defines p-adic negative for each real number  $x$ . An interesting possibility is that p-adic linearity might replace the ordinary linearity in some strongly nonlinear systems so these systems would look simple in the p-adic topology.

These results suggest that canonical identification is involved with some deeper mathematical structure. The following inequalities hold true:

$$\begin{aligned}
 (x + y)_R &\leq x_R + y_R \ , \\
 |x|_p |y|_R &\leq (xy)_R \leq x_R y_R \ ,
 \end{aligned}
 \tag{A-6.9}$$

where  $|x|_p$  denotes p-adic norm. These inequalities can be generalized to the case of  $(R_p)^n$  (a linear vector space over the p-adic numbers).

$$\begin{aligned}
 (x + y)_R &\leq x_R + y_R \ , \\
 |\lambda|_p |y|_R &\leq (\lambda y)_R \leq \lambda_R y_R \ ,
 \end{aligned}
 \tag{A-6.10}$$

where the norm of the vector  $x \in T_p^n$  is defined in some manner. The case of Euclidian space suggests the definition

$$(x_R)^2 = \left( \sum_n x_n^2 \right)_R . \quad (\text{A-6.11})$$

These inequalities resemble those satisfied by the vector norm. The only difference is the failure of linearity in the sense that the norm of a scaled vector is not obtained by scaling the norm of the original vector. Ordinary situation prevails only if the scaling corresponds to a power of  $p$ .

These observations suggests that the concept of a normed space or Banach space might have a generalization and physically the generalization might apply to the description of some non-linear systems. The nonlinearity would be concentrated in the nonlinear behavior of the norm under scaling.

### Modified form of the canonical identification

The original form of the canonical identification is continuous but does not respect symmetries even approximately. This led to a search of variants which would do better in this respect. The modification of the canonical identification applying to rationals only and given by

$$I_Q(q = p^k \times \frac{r}{s}) = p^k \times \frac{I(r)}{I(s)} \quad (\text{A-6.12})$$

is uniquely defined for rationals, maps rationals to rationals, has also a symmetry under exchange of target and domain. This map reduces to a direct identification of rationals for  $0 \leq r < p$  and  $0 \leq s < p$ . It has turned out that it is this map which most naturally appears in the applications. The map is obviously continuous locally since p-adically small modifications of  $r$  and  $s$  mean small modifications of the real counterparts.

Canonical identification is in a key role in the successful predictions of the elementary particle masses. The predictions for the light elementary particle masses are within extreme accuracy same for  $I$  and  $I_Q$  but  $I_Q$  is theoretically preferred since the real probabilities obtained from p-adic ones by  $I_Q$  sum up to one in p-adic thermodynamics.

### Generalization of number concept and notion of imbedding space

TGD forces an extension of number concept: roughly a fusion of reals and various p-adic number fields along common rationals is in question. This induces a similar fusion of real and p-adic imbedding spaces. Since finite p-adic numbers correspond always to non-negative reals  $n$ -dimensional space  $R^n$  must be covered by  $2^n$  copies of the p-adic variant  $R_p^n$  of  $R^n$  each of which projects to a copy of  $R_+^n$  (four quadrants in the case of plane). The common points of p-adic and real imbedding spaces are rational points and most p-adic points are at real infinity.

Real numbers and various algebraic extensions of p-adic number fields are thus glued together along common rationals and also numbers in algebraic extension of rationals whose number belong to the algebraic extension of p-adic numbers. This gives rise to a book like structure with rationals and various algebraic extensions of rationals taking the role of the back of the book. Note that Neper number is exceptional in the sense that it is algebraic number in p-adic number field  $Q_p$  satisfying  $e^p \bmod p = 1$ .

Fig. 15. Various number fields combine to form a book like structure. <http://www.tgdtheory.fi/appfigures/book.jpg>

For a given p-adic space-time sheet most points are literally infinite as real points and the projection to the real imbedding space consists of a discrete set of rational points: the interpretation in terms of the unavoidable discreteness of the physical representations of cognition is natural. Purely local p-adic physics implies real p-adic fractality and thus long range correlations for the real space-time surfaces having enough common points with this projection.

p-Adic fractality means that  $M^4$  projections for the rational points of space-time surface  $X^4$  are related by a direct identification whereas  $CP_2$  coordinates of  $X^4$  at these points are related by  $I$ ,  $I_Q$  or some of its variants implying long range correlates for  $CP_2$  coordinates. Since only a discrete set of points are related in this manner, both real and p-adic field equations can be satisfied and there are no problems with symmetries. p-Adic effective topology is expected to be

a good approximation only within some length scale range which means infrared and UV cutoffs. Also multi-p-fractality is possible.

### A-6.3 The notion of p-adic manifold

The notion of p-adic manifold is needed in order to fuse real physics and various p-adic physics to a larger structure which suggests that real and p-adic number fields should be glued together along common rationals bringing in mind adeles. The notion is problematic because p-adic topology is totally disconnected implying that p-adic balls are either disjoint or nested so that ordinary definition of manifold using p-adic chart maps fails. A cure is suggested to be based on chart maps from p-adics to reals rather than to p-adics (see the appendix of the book)

The chart maps are interpreted as cognitive maps, "thought bubbles" with reverse map interpreted as a transformation of intention to action and would be realized in terms of canonical identification or some of its variants.

Fig. 16. The basic idea between p-adic manifold. <http://www.tgdtheory.fi/appfigures/padmanifold.jpg>

There are some problems.

1. Canonical identification does not respect symmetries since it does not commute with second pinary cutoff so that only a discrete set of rational points is mapped to their real counterparts by chart map arithmetic operations which requires pinary cutoff below which chart map takes rationals to rationals so that commutativity with arithmetics and symmetries is achieved in finite resolution: above the cutoff canonical identification is used
2. Canonical identification is continuous but does not map smooth p-adic surfaces to smooth real surfaces requiring second pinary cutoff so that only a discrete set of rational points is mapped to their real counterparts by chart map requiring completion of the image to smooth preferred extremal of Kähler action so that chart map is not unique in accordance with finite measurement resolution
3. Canonical identification vreaks general coordinate invariance of chart map: (cognition-induced symmetry breaking) minimized if p-adic manifold structure is induced from that for p-adic imbedding space with chart maps to real imbedding space and assuming preferred coordinates made possible by isometries of imbedding space: one however obtains several inequivalent p-adic manifold structures depending on the choice of coordinates: these cognitive representations are not equivalent.

## A-7 Hierarchy of Planck constants and dark matter hierarchy

Hierarchy of Planck constants was motivated by the "impossible" quantal effects of ELF em fields on vertebrate cyclotron energies  $E = hf = \hbar \times eB/m$  are above thermal energy is possible only if  $\hbar$  has value much larger than its standard value. Also Nottale's finding that planetary orbits might be understood as Bohr orbits for a gigantic gravitational Planck constant.

Hierarchy of Planck constant would mean that the values of Planck constant come as integer multiples of ordinary Planck constant:  $h_{eff} = n \times h$ . The particles at magnetic flux tubes characterized by  $h_{eff}$  would correspond to dark matter which would be invisible in the sense that only particle with same value of  $h_{eff}$  appear in the same vertex of Feynman diagram.

Hierarchy of Planck constants would be due to the non-determinism of the Kähler action predicting huge vacuum degeneracy allowing all space-time surfaces which are sub-manifolds of any  $M^4 \times Y^2$ , where  $Y^2$  is Lagrangian sub-manifold of  $CP_2$ . For agiven  $Y^2$  one obtains new manifolds  $Y^2$  by applying symplectic transformations of  $CP_2$ .

Non-determinism would mean that the 3-surface at the ends of causal diamond (CD) can be connected by several space-time surfaces carrying same conserved Kähler charges and having same values of Kähler action. Conformal symmetries defined by Kac-Moody algebra associated with the imbedding space isometries could act as gauge transformations and respect the light-likeness property of partonic orbits at which the signature of the induced metric changes from Minkowskian



to Euclidian (Minkowskian) space-time region transforms to wormhole contact say). The number of conformal equivalence classes of these surfaces could be finite number  $n$  and define discrete physical degree of freedom and one would have  $h_{eff} = n \times h$ . This degeneracy would mean "second quantization" for the sheets of n-furcation: not only one but several sheets can be realized.

This relates also to quantum criticality postulated to be the basic characteristics of the dynamics of quantum TGD. Quantum criticalities would correspond to an infinite fractal hierarchy of broken conformal symmetries defined by sub-algebras of conformal algebra with conformal weights coming as integer multiples of  $n$ . This leads also to connections with quantum criticality and hierarchy of broken conformal symmetries, p-adicity, and negentropic entanglement which by consistency with standard quantum measurement theory would be described in terms of density matrix proportional  $n \times n$  identity matrix and being due to unitary entanglement coefficients (typical for quantum computing systems).

Formally the situation could be described by regarding space-time surfaces as surfaces in singular  $n$ -fold singular coverings of imbedding space. A stronger assumption would be that they are expressible as products of  $n_1$ -fold covering of  $M^4$  and  $n_2$ -fold covering of  $CP_2$  meaning analogy with multi-sheeted Riemann surfaces and that  $M^4$  coordinates are  $n_1$ -valued functions and  $CP_2$  coordinates  $n_2$ -valued functions of space-time coordinates for  $n = n_1 \times n_2$ . These singular coverings of imbedding space form a book like structure with singularities of the coverings localizable at the boundaries of causal diamonds defining the back of the the book like structure.

Fig. 17. Hierarchy of Planck constants. <http://www.tgdtheory.fi/appfigures/planckhierarchy.jpg>

## A-8 Some notions relevant to TGD inspired consciousness and quantum biology

Below some notions relevant to TGD inspired theory of consciousness and quantum biology.

### A-8.1 The notion of magnetic body

Topological field quantization inspires the notion of field body about which magnetic body is especially important example and plays key role in TGD inspired quantum biology and consciousness theory. This is a crucial departure from the Maxwellian view. Magnetic body brings in third level to the description of living system as a system interacting strongly with environment. Magnetic body would serve as an intentional agent using biological body as a motor instrument and sensory receptor. EEG would communicate the information from biological body to magnetic body and Libet's findings from time delays of consciousness support this view.

The following pictures illustrate the notion of magnetic body and its dynamics relevant for quantum biology in TGD Universe.

Fig. 18. Magnetic body associated with dipole field. <http://www.tgdtheory.fi/appfigures/fluxquant.jpg>

Fig. 19. Illustration of the reconnection by magnetic flux loops. <http://www.tgdtheory.fi/appfigures/reconnect1.jpg>

Fig. 20. Illustration of the reconnection by flux tubes connecting pairs of molecules. <http://www.tgdtheory.fi/appfigures/reconnect2.jpg>

Fig. 21. Flux tube dynamics. a) Reconnection making possible magnetic body to "recognize" the presence of another magnetic body, b) braiding, knotting and linking of flux tubes making possible topological quantum computation, c) contraction of flux tube in phase transition reducing the value of  $h_{eff}$  allowing two molecules to find each other in dense molecular soup. <http://www.tgdtheory.fi/appfigures/fluxtubedynamics.jpg>

### A-8.2 Number theoretic entropy and negentropic entanglement

TGD inspired theory of consciousness relies heavily p-Adic norm allows an to define the notion of Shannon entropy for rational probabilities (and even those in algebraic extension of rationals) by replacing the argument of logarithm of probability with its p-adic norm. The resulting entropy can be negative and the interpretation is that number theoretic entanglement entropy defined by this formula for the p-adic prime minimizing its value serves as a measure for conscious information. This negentropy characterizes two-particle system and has nothing to do with the formal negative negentropy assignable to thermodynamic entropy characterizing single particle. Negentropy Maximization Principle (NMP) implies that number theoretic negentropy increases during evolution by quantum jumps. The condition that NMP is consistent with the standard quantum measurement theory requires that negentropic entanglement has a density matrix proportional to unit matrix so that in 2-particle case the entanglement matrix is unitary.

Fig. 22. Schrödinger cat is neither dead or alive. For negentropic entanglement this state would be stable. <http://www.tgdtheory.fi/appfigures/cat.jpg>

### A-8.3 Life as something residing in the intersection of reality and p-adicities

In TGD inspired theory of consciousness p-adic space-time sheets correspond to space-time correlates for thoughts and intentions. The intersections of real and p-adic preferred extremals consist of points whose coordinates are rational or belong to some extension of rational numbers in preferred imbedding space coordinates. They would correspond to the intersection of reality and various p-adicities representing the "mind stuff" of Descartes. There is temptation to assign life to the intersection of realities and p-adicities. The discretization of the chart map assigning to real space-time surface its p-adic counterpart would reflect finite cognitive resolution.

At the level of "world of classical worlds" (WCW) the intersection of reality and various p-adicities would correspond to space-time surfaces (or possibly partonic 2-surfaces) representable in terms of rational functions with polynomial coefficients with are rational or belong to algebraic extension of rationals.

The quantum jump replacing real space-time sheet with p-adic one (vice versa) would correspond to a buildup of cognitive representation (realization of intentional action).

Fig. 23. The quantum jump replacing real space-time surface with corresponding p-adic manifold can be interpreted as formation of thought, cognitive representation. Its reversal would correspond to a transformation of intention to action. <http://www.tgdtheory.fi/appfigures/padictoreal.jpg>

### A-8.4 Sharing of mental images

The 3-surfaces serving as correlates for sub-selves can topologically condense to disjoint large space-time sheets representing selves. These 3-surfaces can also have flux tube connections and this makes possible entanglement of sub-selves, which unentangled in the resolution defined by the size of sub-selves. The interpretation for this negentropic entanglement would be in terms of sharing of mental images. This would mean that contents of consciousness are not completely private as assumed in neuroscience.

Fig. 24. Sharing of mental images by entanglement of subselves made possible by flux tube connections between topologically condensed space-time sheets associated with mental images. <http://www.tgdtheory.fi/appfigures/sharing.jpg>

### A-8.5 Time mirror mechanism

Zero energy ontology (ZEO) is crucial part of both TGD and TGD inspired consciousness and leads to the understanding of the relationship between geometric time and experience time and how the arrow of psychological time emerges. One of the basic predictions is the possibility of negative

energy signals propagating backwards in geometric time and having the property that entropy basically associated with subjective time grows in reversed direction of geometric time. Negative energy signals inspire time mirror mechanism (see fig. <http://www.tgdtheory.fi/appfigures/timemirror.jpg> or fig. 24 in the appendix of this book) providing mechanisms of both memory recall, realization of intentional action initiating action already in geometric past, and remote metabolism. What happens that negative energy signal travels to past and is reflected as positive energy signal and returns to the sender. This process works also in the reverse time direction.

Fig. 25. Zero energy ontology allows time mirror mechanism as a mechanism of memory recall. Essentially "seeing" in time direction is in question. <http://www.tgdtheory.fi/appfigures/timemirror.jpg>

## REFERENCES

# Mathematics

- [A1] Gaussian Mersenne. <http://primes.utm.edu/glossary/xpage/GaussianMersenne.html>.
- [A2] Z. I. Borevich and I. R. Shafarevich. *Number Theory*. Academic Press, 1966.
- [A3] Eisenhart. *Riemannian Geometry*. Princeton University Press, 1964.
- [A4] G. W. Gibbons and C. N. Pope.  $CP_2$  as gravitational instanton. *Comm. Math. Phys.*, 55, 1977.
- [A5] S. W. Hawking and C. N. Pope. Generalized Spin Structures in Quantum Gravity. *Phys. Lett.*, (1), 1978.
- [A6] S. Helgason. *Differential Geometry and Symmetric Spaces*. Academic Press, New York, 1962.
- [A7] C. Iztykson and J-B. Zuber. *Quantum Field Theory*, volume 549. Mc Graw-Hill, New York, 1980.
- [A8] J. Milnor. *Topology form Differential Point of View*. The University Press of Virginia, Virginia, 1965.
- [A9] D. S. Moak. The q-analogue of the Laguerre polynomials. *J. Math. Anal. Appl.*, 81, 1981.
- [A10] C. N. Pope. Eigenfunctions and  $Spin^c$  Structures on  $CP_2$ , 1980.
- [A11] B. Shipman. The geometry of momentum mappings on generalized flag manifolds, connections with a dynamical system, quantum mechanics and the dance of honeybee. <http://math.cornell.edu/~oliver/Shipman.gif>, 1998.
- [A12] M. Spivak. *Differential Geometry I,II,III,IV*. Publish or Perish, Boston, 1970.
- [A13] B. Gilkey T. Eguchi and J. Hanson. *Phys. Rep.*, 66:1980, 1980.
- [A14] R. Thom. *Commentarii Math. Helvet.*, 28, 1954.
- [A15] Wallace. *Differential Topology*. W. A. Benjamin, New York, 1968.
- [A16] E. C. Zeeman. *Catastrophe Theory*. Addison-Wessley Publishing Company, 1977.

# Theoretical Physics

- [B1] J. Björken and S. Drell. *Relativistic Quantum Fields*. Mc Graw-Hill, New York, 1965.
- [B2] K. Huang. *Quarks, Leptons & Gauge Fields*. World Scientific, 1982.
- [B3] R. Kiehn. Electromagnetic waves in vacuum with torsion and spin. <http://www22.pair.com/csdc/pdf/helical6.pdf>.
- [B4] G. Parisi. *Field Theory, Disorder and Simulations*. World Scientific, 1992.
- [B5] A. Zee. *The Unity of Forces in the Universe*. World Science Press, Singapore, 1982.

# Particle and Nuclear Physics

- [C1] Cold fusion is back at the American Chemical Society. <http://www.nature.com/news/2007/070326/full/070326-12.html>.
- [C2] Cold fusion links. <http://www.teleport.com/~genel/coldf.html>.
- [C3] Infinite energy magazine. <http://www.mv.com/ipusers/zeropoint/>.
- [C4] Lithium. <http://en.wikipedia.org/wiki/Lithium>.
- [C5] Summaries of Widom-Larsen theory. <http://newenergytimes.com/v2/sr/WL/WLTheory.shtml#summary>.
- [C6] The Berkeley Laboratory Isotopes Project's Exploring the Table of Isotopes. [http://ie.lbl.gov/education/parent/Ti\\_iso.htm](http://ie.lbl.gov/education/parent/Ti_iso.htm).
- [C7] Widom-Larsen LENR Theory Portal. <http://newenergytimes.com/v2/sr/WL/WLTheory.shtml>.
- [C8] Mizuno-Omori Cold Fusion Reactor. *Infinite Energy Magazine*, (20), 1998.
- [C9] Rossi Reactor. [http://en.wikipedia.org/wiki/Rossi\\_Reactor](http://en.wikipedia.org/wiki/Rossi_Reactor), 2011.
- [C10] Abragam A. *The principles of nuclear magnetism*. Clarendon Press, Oxford, 1961.
- [C11] Robert Bass. Cincinnati group announces transmutation of radiation waste into useful metals using "table-top" energy levels!, 1997.
- [C12] C. A. Bertulani and V. Zelevinsky. Is the tetra-neutron a bound dineutron-dineutron molecule? *J. Phys. G*. <http://arxiv.org/abs/nucl-th/0212060>, 29, 2002.

- [C13] O. Dmitriyeva. Mechanism of heat generation from loading gaseous hydrogen isotopes into palladium nanoparticles. <http://ecee.colorado.edu/~model/QEL/Papers/DmitriyevaThesis12.pdf>, 2010.
- [C14] B. R. Barber et al. *Phys. Rev.*, 72(9):1380, 1994.
- [C15] C. Rolfs et al. First hints on a change of the  $^{22}\text{Na}$  beta decay half-life in the metal Pd. *Eur. Phys. J. A*, 28, 2006.
- [C16] C. Rolfs et al. High-Z electron screening, the cases  $^{50}\text{V}(p,n)^{50}$ . *Eur. Phys. J. A*, 28, 2006.
- [C17] F. M. Marquez et al. *Phys. Rev. C*, 65, 2003.
- [C18] J. H. Jenkins et al. Evidence for Correlations Between Nuclear Decay Rates and Earth-Sun Distance. <http://arxiv.org/abs/0808.3283>, 2008.
- [C19] R. P. Taleyarkhan et al. Nuclear Emissions During Self-Nucleated Acoustic Cavitation. <http://adsabs.harvard.edu/abs/2006PhRvL..96c4301T>, 2006.
- [C20] S. E. Shnoll et al. Realization of discrete states during fluctuations in macroscopic processes. *Uspekhi Fisicheskikh Nauk*, 41(10):1025–1035, 1998.
- [C21] T. Ditmire et al. High energy ions produced in explosions of superheated atomic clusters. *Nature*, 386:55, March 1997.
- [C22] T. Mizuno et al. Hydrogen Evolution by Plasma Electrolysis in Aqueous solution. *Japanese Journal of Applied Physics*, 44(1):396–401, 2002.
- [C23] V. M. Lobashev et al. In *Neutrino 96*, Singapore, 1996. World Scientific.
- [C24] S. Focardi and A. Rossi. A new energy source from nuclear fusion. [http://www.nyteknik.se/incoming/article3080659.ece/BINARY/Rossi-Focardi\\_paper.pdf](http://www.nyteknik.se/incoming/article3080659.ece/BINARY/Rossi-Focardi_paper.pdf), 2011.
- [C25] K. Langanke H. J. Assenbaum and C. Rolfs. *Z. Phys. A*, 327, 1987.
- [C26] P. L. Hagelstein and I. U. Chaudhary. Electron mass shift in nonthermal systems. <http://arxiv.org/abs/0801.3810>, 2008.
- [C27] R. Howard. *Nuclear Physics*. Wadsworth Publishing Company, Inc., 1963.
- [C28] C. Illert. ALCHEMY TODAY-Platonic Geometries in Nuclear Physics. *Science*, 1, 1993.
- [C29] C. L. Kervran. *Biological Transmutations*. Swan House Publishing Co., 1972.
- [C30] C. L. Kervran. *Biological transmutations, and their applications in chemistry, physics, biology, ecology, medicine, nutrition, agriculture, geology*. Swan House Publishing Co., 1972.
- [C31] A. D. Krisch. The spin of proton. *Scientific American*, May 1979.
- [C32] S. Pons M. Fleischmann and M. Hawkins. Electrochemically induced nuclear fusion of deuterium. *J. Electroanal. Chem.*, 261:263, 1989.
- [C33] J. Naudin. Cold Fusion reactor experimental test results. <http://jlnlabs.online.fr/cfr/html/cfrdatas.htm>, 2003.
- [C34] C. Rolfs and W. S. Rodney. *Cauldrons in the Cosmos*. University of Chicago Press, Chicago, 1988.
- [C35] Jed Rothwell. Some recent developments in cold fusion. <http://ourworld.compuserve.com/homepages/JedRothwell/brieftec.htm>, 1996.
- [C36] J. Schwinger. Energy Transfer In Cold Fusion and Sonoluminescence. <http://jcbmac.chem.brown.edu/baird/coldfusion/schwinger.html>, 1992.
- [C37] V. J. Stenger. ESP and Cold Fusion: parallels in pseudoscience. <http://www.phys.hawaii.edu/vjs/www/cold.txt>, 1995.

- [C38] E. Storms. Review of cold fusion effect. <http://www.jse.com/storms/1.html>, 1996.
- [C39] E. Storms. Formation of b-PdD Containing High Deuterium Concentration Using Electrolysis of Heavy-Water. <http://home.netcom.com/~storms2/review4.html>, 1998.
- [C40] E. Storms. Cold fusion, an objective assessment. <http://home.netcom.com/~storms2/review8.html>, 2001.
- [C41] P. Tompkins and C. Bird. *The secret life of plants*. Harper & Row, New York, 1973.
- [C42] J. E. Ungar. Double Charge Exchange of pions on  $^4\text{He}$ . [http://etd.caltech.edu/etd/available/etd-11032005-112918/unrestricted/Ungar\\_je\\_1983.pdf](http://etd.caltech.edu/etd/available/etd-11032005-112918/unrestricted/Ungar_je_1983.pdf), 1982.
- [C43] A. Widom and L. Larsen. Absorption of Nuclear Gamma Radiation by Heavy Electrons on Metallic Hydride Surfaces. <http://arxiv.org/abs/cond-mat/0509269>, 2005.
- [C44] A. Widom and L. Larsen. Theoretical Standard Model Rates of Proton to Neutron Conversions Near Metallic Hydride Surfaces. <http://arxiv.org/abs/nucl-th/0608059>, 2006.
- [C45] A. Widom and L. Larsen. Theoretical Standard Model Rates of Proton to Neutron Conversions Near Metallic Hydride Surfaces. <http://arxiv.org/abs/nucl-th/0608059>, 2007.

## Condensed Matter Physics

- [D1] Burning salt water. <http://www.youtube.com/watch?v=aGg0ATfoBgo>.
- [D2] Electrolysis of water. [http://en.wikipedia.org/wiki/Electrolysis\\_of\\_water](http://en.wikipedia.org/wiki/Electrolysis_of_water).
- [D3] Fractional quantum Hall Effect. [http://en.wikipedia.org/wiki/Fractional\\_quantum\\_Hall\\_effect](http://en.wikipedia.org/wiki/Fractional_quantum_Hall_effect).
- [D4] Hydrogen bonds. [http://en.wikipedia.org/wiki/Hydrogen\\_bond](http://en.wikipedia.org/wiki/Hydrogen_bond).
- [D5] Phase conjugation. <http://www.usc.edu/dept/ee/People/Faculty/feinberg.html>.
- [D6] Pyrolysis. <http://en.wikipedia.org/wiki/Pyrolysis>.
- [D7] Rotational energies of molecules. <http://hyperphysics.phy-astr.gsu.edu/HBASE/molecule/rotrig.html#c3>.
- [D8] MIT discovers a new state of matter - a new kind of magnetism. <http://www.extremetech.com/extreme/143782-mit-discovers-a-new-state-of-matter-a-new-kind-of-magnetism>, 2013.
- [D9] Quantum entangled batteries could be the perfect power source. <http://www.extremetech.com/extreme/139857-quantum-entangled-batteries-could-be-the-perfect-power-source>, 2013.
- [D10] O. Balcou and L. Durtriaux. *Phys. Rev.*, 78, 1997.
- [D11] J. K. Borchardt. The chemical formula H<sub>2</sub>O - a misnomer. *The Alchemist*, August 2003.
- [D12] M. Chaplin. Water Structure and Behavior. <http://www.lsbu.ac.uk/water/index.html>, 2005.

- [D13] R. Y. Chiao. Super-conductors as transducers and antennas for gravitational and electromagnetic radiation. <http://arxiv.org/abs/gr-gc/0204012>.
- [D14] R. Y. Chiao. Tunnelling Times and Super-luminality: a Tutorial, November 1998.
- [D15] R. Y. Chiao and A. M. Steinberg. In E. Wolf, editor, *Progress in Optics XXXVII*, volume 345, Amsterdam, 1997. Elsevier.
- [D16] R. A. Cowley. Neutron-scattering experiments and quantum entanglement. *Physica B*, 350:243–245, 2004.
- [D17] B. R. Barber et al. *Phys. Rev.*, 72(9):1380, 1994.
- [D18] D. J. Evans et al. Experimental Demonstration of Violations of the Second Law of Thermodynamics for Small Systems and Short Time Scales. *Phys. Rev.*, 89, 2002.
- [D19] F. Levy et al. Magnetic Field-Induced Super-conductivity in the Ferromagnet URhGe. *Science*, August 2005.
- [D20] G. A Melkov et al. *Phase Conjugation of Linear and Nonlinear Signals of Magnetostatic Waves*. Trans Tech Publications, Switzerland, 2001.
- [D21] G. Nimtz et al. *J. Phys.*, 4, 1994.
- [D22] J. B. Miller et al. Fractional Quantum Hall effect in a quantum point contact at filling fraction 5/2. <http://arxiv.org/abs/cond-mat/0703161v2>, 2007.
- [D23] R. Mills et al. Spectroscopic and NMR identification of novel hybrid ions in fractional quantum energy states formed by an exothermic reaction of atomic hydrogen with certain catalysts. <http://www.blacklightpower.com/techpapers.html>, 2003.
- [D24] R. Moreh et al. Search for anomalous scattering of keV neutrons from H<sub>2</sub>O-D<sub>2</sub>O mixtures. *Phys. Rev.*, 94, 2005.
- [D25] W. D. Knight et al. *Phys. Rev.*, 52, 1984.
- [D26] S. M. Girvin. Quantum Hall Effect, Novel Excitations and Broken Symmetries. <http://arxiv.org/abs/cond-mat/9907002>, 1999.
- [D27] J. K. Jain. *Phys. Rev.*, 63, 1989.
- [D28] P. Kanarev. Water is New Source of Energy. *Krasnodar*, 2002.
- [D29] P. Kanarev and T. Mizuno. Cold fusion by plasma electrolysis of water. <http://www.guns.connect.fi/innoplaza/energy/story/Kanarev/codlfusion/>, 2002.
- [D30] I. Langmuir. *Journal of American Chemical Society*, 37, 1915.
- [D31] R. B. Laughlin. *Phys. Rev.*, 50, 1990.
- [D32] J-C. Li and D.K. Ross. Evidence of Two Kinds of Hydrogen Bonds in Ices. *Nature*, 365:327–329, 1993.
- [D33] R. Mackenzie and F. Wilczek. *Rev. Mod. Phys. A*, 3:2827, 1988.
- [D34] S. Meyer. Water Fuel Cell. International News Release, No. 11 A-Rv., 1996.
- [D35] D. M. Pepper. Nonlinear Optical Phase Conjugation. *Optical Engineering*, 21(2), March 1982.
- [D36] H. Puthoff. Ground State of Hydrogen as a Zero-Point Fluctuation Determined State. *Phys. Rev. D*, 35, 1987.
- [D37] V. V. Shkunov and B. Ya. Zeldovich. Optical Phase Conjugation. *Scientific American*, 1985.

- [D38] D. D. Stancil. *Theory of Magnetostatic Waves*. Springer Verlag, 1993.
- [D39] A. M. Steinberg and R. Y. Chiao. Sub-femtosecond determination of transmission delay times for a dielectric mirror (photonic bandgap) as a function of angle of incidence. <http://arxiv.org/abs/quant-ph/9501013>, 1995.
- [D40] L. Wang. *Nature*, July 2000.

## Cosmology and Astro-Physics

- [E1] Age of the universe. [http://en.wikipedia.org/wiki/Age\\_of\\_the\\_universe](http://en.wikipedia.org/wiki/Age_of_the_universe).
- [E2] Allais effect. [http://en.wikipedia.org/wiki/Allais\\_effect](http://en.wikipedia.org/wiki/Allais_effect).
- [E3] Cavendish experiment. [http://en.wikipedia.org/wiki/Cavendish\\_experiment](http://en.wikipedia.org/wiki/Cavendish_experiment).
- [E4] French Nobel Laureate turns back clock. [http://science.nasa.gov/newhome/headlines/ast12oct99\\_1.htm](http://science.nasa.gov/newhome/headlines/ast12oct99_1.htm).
- [E5] French Nobel Laureate turns back clock: Marshall's global experiment, von Braun memories evoked during August 11 solar eclipse. [http://science.nasa.gov/newhome/headlines/ast12oct99\\_1.htm](http://science.nasa.gov/newhome/headlines/ast12oct99_1.htm).
- [E6] Saturn. <http://en.wikipedia.org/wiki/Saturn>.
- [E7] Saturnus. <http://en.wikipedia.org/wiki/Saturn>.
- [E8] Standard Solar Model. [http://en.wikipedia.org/wiki/Standard\\_Solar\\_Model](http://en.wikipedia.org/wiki/Standard_Solar_Model).
- [E9] 13 more things: The lithium problem. *New Scientist*. <http://www.newscientist.com/article/mg20327246.700-13-more-things-the-lithium-problem.html>, (2724), 2009.
- [E10] M. Allais. Should the Laws of Gravitation be modified?: Part I -Abnormalities in the Motion of a Paraconical Pendulum with Anisotropic Support. *Aero/Space Engineering*, 1959, 1959.
- [E11] M. Allais. Should the Laws of Gravitation be modified?: Part II -Experiments in Connection with the Abnormalities the Motion of a Paraconical Pendulum with an Isotropic Support. *Aero/Space Engineering*, October 1959.
- [E12] M. Allais. Should the Laws of Gravitation Be Reconsidered: Part I,II,III? <http://home.t01.itscom.net/allais/blackprior/allais/lawgravit/lawgrav-one.pdf>, 1959.
- [E13] C. Charbonnel and F. Primas. The lithium content of the Galactic Halo stars. <http://arxiv.org/abs/astro-ph/0505247>, 2005.
- [E14] B. R. Heckel E. G. Adelberger and A. E. Nelson. Tests of Gravitational Inverse-Square Law. <http://www.npl.washington.edu/eotwash/pdf/review.pdf>, 2005.
- [E15] J. A. Eddy and A. A. Boornazian. Secular decrease in the solar diameter. *Bulletin of the American Astronomical Society*, 11(437):1863–1953, 1979.
- [E16] E. Caffau et al. An extremely primitive halo star. <http://www.eso.org/public/archives/releases/sciencepapers/eso1132/eso1132.pdf>, 2011.



- [E17] I. Mihaila et al. A new confirmation of the Allais effect during the solar eclipse of 31 2003 May. <http://home.t01.itscom.net/allais/blackprior/mihaila/2003/mihaila2003.pdf>, 2003.
- [E18] M. Tajmar et al. Experimental Detection of Gravimagnetic London Moment. <http://arxiv.org/abs/gr-gc0603033>, 2006.
- [E19] Qian-Shen Wang et al. Precise measurement of gravity variations during a total solar eclipse. *Phys. Rev. D*. <http://home.t01.itscom.net/allais/blackprior/wang/wangetal.pdf>, 62, 2000.
- [E20] S. E. Shnoll et al. Realization of discrete fluctuations in macroscopic processes. *Physics-Uspeski*. <http://home.t01.itscom.net/allais/blackprior/shnoll/shnoll-1.pdf>, 41(10):1025–1035, 1998.
- [E21] G. I. Rusu G. T. Jeverdan and V. Antonescu. Experiments using the Foucault pendulum during the solar eclipse of 15 February, 1961. *Biblical Astronomer*, 1(55), 1981.
- [E22] G. T. Gilles. *American J. of Physics*, 58, 1990.
- [E23] R. L. Gilliland. Solar radius variations over the past 265 years. *Astrophysical Journal*, 248:1155, 1981.
- [E24] J. C. Howk J. Prochaska and A. M. Wolfe. The elemental abundance pattern in a galaxy at  $z = 2.626$ . *Nature*, 423, 2003.
- [E25] U. E. Kruse and R. N. Tran. Cavendish experiment. <http://www.ccsr.uiuc.edu/~alfred/Ph101/Notes.htm/cavendish/index.html>, 1995.
- [E26] S. Dimopoulos N. Arkani-Hamed and G. Dvali. The Hierarchy Problem and New Dimensions at a Millimeter. <http://arxiv.org/abs/hep-ph/9803315>, 1998.
- [E27] V. A. Popescu and D. Olenici. A confirmation of the Allais and Jeverdan-Rusu-Antonescu effects during the solar eclipse from 22 September 2006, and the quantization behavior of pendulum. <http://www.hessdalen.org/sse/program/Articol.pdf>, 2007.
- [E28] M. Holman R. Malhotra and T. Ito. Chaos and stability of the solar system. *Proc. Natl. Acad. Sci. USA*. <http://www.pubmedcentral.nih.gov/articlerender.fcgi?artid=60054>, 98:12342–12343, October 2001.
- [E29] D. Da Roacha and L. Nottale. Gravitational Structure Formation in Scale Relativity. <http://arxiv.org/abs/astro-ph/0310036>, 2003.

## Physics of Earth

- [F1] Ionosphere. <http://en.wikipedia.org/wiki/Ionosphere>.
- [F2] Kennelly-Heaviside layer. [http://en.wikipedia.org/wiki/Kennelly-Heaviside\\_layer](http://en.wikipedia.org/wiki/Kennelly-Heaviside_layer).
- [F3] Plate tectonics. [http://en.wikipedia.org/wiki/Plate\\_tectonics](http://en.wikipedia.org/wiki/Plate_tectonics).
- [F4] Tides. <http://en.wikipedia.org/wiki/Tides>.
- [F5] L. A. Frank et al. Plasma velocity distributions in the near-Earth plasma sheet: A first look with the Geotail spacecraft. *J. Geophys. Res.*, 101:10627–10637, 1996.

- [F6] G. Paschmann W. Baumjohann and C. A. Cattell. Average plasma properties in the central plasma sheet. *J. Geophys. Res.*, 94, 1989.
- [F7] E. R. Williams. Sprites, Elves, and Glow Discharge Tubes. *Physics to Day*, 52(11), 2001.

## Fringe Physics

- [H1] Chilbolton crop circle. <http://www.cropcircleresearch.com/articles/arecibo.html>.
- [H2] Chilbolton crop circle. <http://claudescommentary.com/special/chilbolton/>.
- [H3] The device of marcus hollingshead is discussed in antigravity discussion group. <http://groups.yahoo.com/group/Antigravity/?yguid=74088422>.
- [H4] M. B. King. Free-energy devices. <http://www.free-energy-info.co.uk/MorayKing.pdf>.
- [H5] P. Vigay's homepage about Crop Circle Research. <http://www.cropcircleresearch.com/articles/alienface.html>.
- [H6] The Home of Primordial Energy. <http://www.depalma.pair.com>.
- [H7] The homepage of Martin Keitel. <http://www.ioon.net/martian/>.
- [H8] The homepage of Juha Hartikka. <http://energy.innoplaza.net>.
- [H9] The Quest for Over-Unity. <http://jnaudin.free.fr/>.
- [H10] Thomas Townsend Brown. <http://www.virtualtheater.com/ttbrown-01.html>.
- [H11] Teslas Wireless Energy... For the 21st Century!!! One Step Beyond Direct TV!!! <http://www.teslatech.info/ttmagazine/v1n4/valone.htm>, 2003.
- [H12] A. Akai. Longitudinal waves. Cold electricity. *New Energy Technologies*. <http://www.slashdocs.com/inixhk/longitudinal-waves-cold-electricity.html>.
- [H13] D. W. Akers. The Toppenish Field Study. A Technical Review and Update. In *The 7:th European SSE Meeting August 17-19, 2007, Røros, Norway. Proceedings*, 2007.
- [H14] A. E. Akimov. Torsion Technologies are XXI Age Technologies. *New Energy Technologies*, 1, July 2001.
- [H15] S. D. Allan. Perendev is Tooling Up for Magnetic Motor Mass Production in Europe. *Pure Energy Systems News*. <http://pesn.com/2004/06/30/6900029PerendevPowerMagneticMotor/>, 2004.
- [H16] S. D. Allan. 35+ Reasons Why I Think Yildiz Magnetic Motor Really Works. *New Illuminati*. <http://nexusilluminati.blogspot.fi/2013/06/introducing-yildiz-magnetic-motor.html>, 2013.
- [H17] T. B. Bahler and G. Fazi. Force on an Asymmetric Capacitor. [http://membres.lycos.fr/jlnlabs/ar1\\_fac/index.html](http://membres.lycos.fr/jlnlabs/ar1_fac/index.html), 2002.
- [H18] V. G. Baryshevsky and L. N. Korennaya. *Doklady AN BSSR*, 12:1, 1965.
- [H19] G. Burridge. In *Townsend Brown and his antigravity discs*, 1994.

- [H20] B. DePalma. Notes on Faraday disc. <http://www.depalma.pair.com>, 1995.
- [H21] J. L. Duarte. Introducing the Yildiz magnetic motor. New Illuminati. <http://nexusilluminati.blogspot.fi/2013/06/introducing-yildiz-magnetic-motor.html>, 2013.
- [H22] S. Ejaz and S. Anwar. Voltage distribution along reactor winding under very fast transients. Masters's thesis in Chalmers. <http://home.comcast.net/~onichelson/VOLTGN.pdf><http://publications.lib.chalmers.se/records/fulltext/171671/171671.pdf> .
- [H23] Akimov et al. Predvaritelnyye rezultaty astronomicheskikh nabludenii po metodike N. A. Kozyreva, 1992.
- [H24] F. W. Hehl et al. General relativity with spin and torsion: Foundations and prospects. *Rev. Mod. Phys.*, (3):393, 1976.
- [H25] E. Foschi G. Levi and H. Essen. Indication of anomalous heat energy production in a reactor containing hydrogen loaded nickel powder. <http://arxiv.org/pdf/1305.3913.pdf>, 2013.
- [H26] Björn Gitle-Hauge. Optical spectrum analysis of the Hessdalen phenomenon. In *The 7<sup>th</sup> European SSE Meeting, August 17-19, 2007, Røros, Norway. Proceedings*, 2007.
- [H27] H. Hayasaka and S. Takeuchi. Anomalous weight reduction on a gyroscopes right rotation around the vertical axis of the earth. *Phys. Rev.*, 25:2701, 1989.
- [H28] T. W. B. Kibble. *J. Math. Phys.*, 2:212, 1961.
- [H29] M. B. King. Water Electrolyzers and the Zero-Point Energy. *Physics Procedia*. <http://www.sciencedirect.com/science/journal/18753892>, 20:335–445, 2011.
- [H30] W. Kopczynski. A non-singular Universe with torsion. *Phys. Lett. A*, 1972:219, 1972.
- [H31] N. A. Kozyrev. *Prichinnaya ili nesimmetrichnaya mekhanika v lineinom priblizhenii*. GAO AN SSSR, Leningrad, 1958.
- [H32] N. A. Kozyrev. *Izbrannyye trudy*. Leningrad State University, 1991.
- [H33] P. LaViolette. *How the Searl Effect Works: an Analysis of the Magnetic Energy Converter*. Jupiter Verlag, 2001.
- [H34] P. Lindeman. *The free energy secrets of cold electricity*. [http://www.teslasociety.ch/info/NTV\\_2011/free.pdf](http://www.teslasociety.ch/info/NTV_2011/free.pdf). Clear Tech, Inc.
- [H35] G. Modanese. On the theoretical interpration of E. Podkletnov's experiment. <http://www.gravity.org/ont.html>, 1996.
- [H36] H. Morgan. *Aerospace and Electronic Systems*, pages 5–10, January 1998.
- [H37] Yu. V. Nachalov. Theoretical basis of experimental phenomena. <http://www.amasci.com/freenrg/tors/tors3.html>, 1999.
- [H38] Yu. V. Nachalov and A.N. Sokolov. Experimental investigation of new long-range interactions. <http://www.amasci.com/freenrg/tors/doc17.html>, 1999.
- [H39] J. Naudin. Free Energy Atomic Hydrogen: the MAHG project. <http://jlnlabs.imars.com/mahg/tests/index.htm>, 2005.
- [H40] O. Nichelson. A Special Case of Voltage Gain. <http://home.comcast.net/~onichelson/VOLTGN.pdf>.
- [H41] O. Nichelson. Nikola Tesla's later energy generation designs. <http://home.earthlink.net/~drestinblack/generator.htm>. 1991.

- [H42] S. Ouyang and Y. Lin. On spinning of matters and some important studies absent in contemporary science. *Scientific Inquiry*. <http://www.igss.net/Scientific-Inquiry/OuYangI.pdf>, 7(1):55–62, June 2006.
- [H43] E. Podkletnov and G. Modanese. Investigation of high voltage discharges in low pressure gases through large ceramic super-conducting electrodes. <http://xxx.lanl.gov/abs/physics/0209051>, 2002.
- [H44] E. Podkletnov and R. Nieminen. Weak gravitational shielding properties of composite bulk YBa<sub>2</sub>Cu<sub>3</sub>O<sub>7-x</sub> super-conductor below 70 K under electro-magnetic field. <http://arxiv.org/abs/cond-mat/9701074>, 1992.
- [H45] V. G. Pokozaniev and G. V. Skrotskii. *Uspekhi Fisicheskikh Nauk*, 129(4), 1979.
- [H46] T. V. Prevenslik. Bubbles and Steam Electricity. *ESD Journal*. <http://www.esdjournal.com/techpaper/prevens/previndex.htm>, 2013.
- [H47] V. V. Roschin and S. M. Godin. *Generator with Energy Conversion and Anti-Gravity Effects*. Jupiter Verlag, 2001.
- [H48] M. Rose. "The Flying Saucer". The Application of the Biefeld-Brown Effect to the Solution of the Problems of Space Navigation. <http://www.soteria.com/brown/docs/rose.htm>, 1952.
- [H49] V. V. Roshchin and S. M. Godin. An Experimental Investigation of the Physical Effects in a Dynamic Magnetic System. *New Energy Technologies*, 1, 2001.
- [H50] J. Schnurer. Demonstration of transient weak gravitational shielding by a YBCO LEVHEX at the super-conducting transition. <http://www.gravity.org/exp.htm>, 1999.
- [H51] D. W. Sciama. *Rev. Mod. Phys.*, 36:463, 1964.
- [H52] G. I. Shipov. *Teoriya fizicheskogo vakuuma*. Moscow, NT-Centr, Moscow, 1993.
- [H53] N. Tesla. Coil for Electromagnets. <http://www.tfcbooks.com/patents/coil.htm>, 1894.
- [H54] A. Trautman. *Symp. Math.*, (1):139, 1973.
- [H55] T. van Flandern. *Phys. Lett. A*, 250(1-3):1–11, 1998.
- [H56] G. Vassilatos. Secrets of Cold War Technology: Project HAARP and Beyond. *Science*, 1996.

## Biology

- [I1] Diffuse interstellar band. [http://en.wikipedia.org/wiki/Diffuse\\_interstellar\\_band](http://en.wikipedia.org/wiki/Diffuse_interstellar_band).
- [I2] Diffuse interstellar bands. [http://en.wikipedia.org/wiki/Diffuse\\_interstellar\\_band](http://en.wikipedia.org/wiki/Diffuse_interstellar_band).
- [I3] From the stars to the thought. <http://www.brunonic.org/Nicolaus/fromthestarstot.htm>.
- [I4] Interstellar Dust as Agent and Subject of Galactic Evolution. [http://www.ricercaitaliana.it/prin/dettaglio\\_completo\\_prin\\_en-2005022470.htm](http://www.ricercaitaliana.it/prin/dettaglio_completo_prin_en-2005022470.htm).
- [I5] Magnetic Bees. <http://www.abc.net.au/science/k2/trek/4wd/0ver57.htm>.

- [I6] Nanobacterium. <http://en.wikipedia.org/wiki/Nanobacterium>.
- [I7] Nanobe. <http://en.wikipedia.org/wiki/Nanobe>.
- [I8] Photocatalysis. <http://en.wikipedia.org/wiki/Photocatalysis>.
- [I9] Photolysis. <http://en.wikipedia.org/wiki/Photolysis>.
- [I10] Photosynthesis. <http://en.wikipedia.org/wiki/Photosynthesis>.
- [I11] Pollack Laboratory- Biographical Sketch. <http://faculty.washington.edu/ghp/cv/>.
- [I12] Spark of life: Metabolism appears in lab without cells. <http://www.newscientist.com/article/dn25471-spark-of-life-metabolism-appears-in-lab-without-cells.html?cmpid=RSS|NSNS|2012-GLOBAL|online-news#.U14rRMZK7B3>.
- [I13] The First National Conference on the Bigu Manifestation, Health Effects and Scientific Research of Yan Xin Qigong. <http://www.scribd.com/doc/40294944/Bigu-Conference-Report-PennState-June-2000>.
- [I14] Virus. <http://en.wikipedia.org/wiki/Virus>.
- [I15] *Aids: Biological Warfare*, volume 1649, P. O.Box 1649, Greenville, TX 75401, 1988. Tesla Book Company.
- [I16] Why honeybees never forget a face? *New Scientist*, page 22, December 2005.
- [I17] The Fourth Phase of Water: Dr. Gerald Pollack at TEDxGuelphU. <https://www.youtube.com/watch?v=i-T7tCMUDXU>, 2014.
- [I18] G. Albrecht-Buehler. Reversible excitation light-induced enhancement of fluorescence of live mammalian mitochondria. *FASEB J.* <http://www.basic.northwestern.edu/g-buehler/relief.htm>, 2000.
- [I19] J. B. Bateman. A Biologically Active Combination of Modulated Magnetic and Microwave Fields: the Priore Machine,. Office of Naval Research. London Report R-5-78. August 1978, 1978.
- [I20] S. Clement. Magnetic Microbes. <http://commtechlab.msu.edu/sites/dlc-me/curious/ca0c965C.html>, 1996.
- [I21] International Human Sequencing Consortium. Initial sequencing and analysis of the human genome. *Nature*, February 2001.
- [I22] R. E. Cremesti and P. Baternan. Problems with the search for the origin of life. [http://cremesti.com/portfolio/technical\\_writing/Academic\\_Research\\_Papers/Problems\\_With\\_The\\_Search\\_For\\_The\\_Origin\\_of\\_Life.htm](http://cremesti.com/portfolio/technical_writing/Academic_Research_Papers/Problems_With_The_Search_For_The_Origin_of_Life.htm), 1998.
- [I23] B. Tsytoich et al. From Plasma crystals and helical structures towards inorganic living matter. *New Journal of Physics*. <http://www.iop.org/EJ/abstract/1367-2630/9/8/263>, August 2007.
- [I24] E. O. Kajander et al. Comparison of Staphylococci and Novel Bacteria-Like Particles from Blood. *Zbl. Bakt. Suppl.*, 26, 1994.
- [I25] G.N. Ling et al. Experimental confirmation, from model studies, of a key prediction of the polarized multilayer theory of cell water. *Physiological Chemistry and Physics*, 10(1):87-88, 1978.
- [I26] J. P. Dobson et al. Evocation of epileptiform activity by weak DC magnetic fields. *American Geophysical Union Meeting, Baltimore, Maryland. EOS*, (16), 1993.
- [I27] M. Desoil et al. Definitive identification of magnetite nanoparticles in the abdomen of the honeybee *Apis mellifera*. *Journal of Physics: Conference Series*, 17, 2005.

- [I28] P. P. Gariaev et al. The spectroscopy of bio-photons in non-local genetic regulation. *Journal of Non-Locality and Remote Mental Interactions*. <http://www.emergentmind.org/gariaevI3.htm>, (3), 2002.
- [I29] R. D. Kortschak et al. EST Analysis of the Cnidarian *Acropora millepora* Reveals Extensive Gene Loss and Rapid Sequence Divergence in the Model Invertebrates. *Current Biology*. <http://www.current-biology.com/content/article/fulltext?uid=PIIS0960982203008728>, pages 2190–2195, 2003.
- [I30] R. L. Folk. Nanno-bacteria; surely not figments but what heaven are they? *Natural science*. <http://naturalSCIENCE.com>, 1, 1997.
- [I31] Celera Genomics. *Science*, 291(5507), February.
- [I32] S. J. Gould. *Wonderful Life*. Penguin Books, 1991.
- [I33] G. T. Javor. *Origins*. <http://origins.swau.edu/papers/life/javor1/default.html>, 14:7–20, 1987.
- [I34] C. King. Biocosmology. <http://www.dhushara.com/book/biocos/biocos.pdf>, 2003.
- [I35] J. L. Kirschvink. Constraints on biological effects of weak extremely-low-frequency electromagnetic fields'. *Phys. Rev. A*. [http://prola.aps.org/abstract/PRA/v46/i4/p2178\\_1](http://prola.aps.org/abstract/PRA/v46/i4/p2178_1), 43(1991), 1992.
- [I36] M. P. Bernstein L. J. Allamandola and S.A. Sandford. *Astronomical and biochemical origins and the search for life in the universe*. Editrice Compositori, Bologna, 1997.
- [I37] E. Levich. *Phys. Rep.*, 3, 1987.
- [I38] G. Ling. Three sets of independent disproofs against the membrane-pump theory. <http://www.gilbertling.org/lp6a.htm>, 1978.
- [I39] G. Ling. Oxidative phosphorylation and mitochondrial physiology: a critical review of chemiosmotic theory and reinterpretation by the association-induction hypothesis. *Physiol. Chem. & Physics*, 13, 1981.
- [I40] G. N. Ling. *A physical theory of the living state: the association-induction hypothesis; with considerations of the mechanics involved in ionic specificity*. Blaisdell Pub. Co., New York, 1962.
- [I41] G. N. Ling. Maintenance of low sodium and high potassium levels in resting muscle cells. *Journal of Physiology (Cambridge)*, pages 105–123, July 1978.
- [I42] G. N. Ling. *A revolution in the physiology of the living cell*. Malabar, FL: Krieger Pub. Co., 1992.
- [I43] E. Lozneau and M. Sandulovicu. Minimal-cell system created in laboratory by self-organization. *Chaos, Solitons & Fractals*, 18(2):335, September 2003.
- [I44] L. Margulis and M. F. Dolan. *Early Life*. Jones and Bartlett Publ. MA., 2002.
- [I45] V. Matveev. Main principles of Lings physical theory of the living cell. <http://vladimirmatveev.ru/mainprinciples.html>, 2012.
- [I46] G. F. Gahm P. Carlquist and H. Kristen. Theory of twisted trunks. <http://www.aanda.org/articles/aa/abs/2003/20/aa3289/aa3289.html>, 2003.
- [I47] G. Pollack. *Cells, Gels and the Engines of Life*. Ebner and Sons, 2000.
- [I48] F.-A. Popp and J.-J. Chang. Photon Sucking and the Basis of Biological Organization. <http://www.datadiwan.de/iib/ib0201e3.htm>, 2001.
- [I49] G. Rein. Biological Effects of Quantum Fields and Their Role in the Natural Healing Process. *Frontier Perspectives*, pages 16–23, 1998.

- [I50] D. Robson. Researchers Seek to Demystify the Metabolic Magic of Sled Dogs. [http://www.nytimes.com/2008/05/06/science/06dogs.html?\\_r=1&ex=1210737600&en=313979157c777587&ei=5070&emc=eta-1](http://www.nytimes.com/2008/05/06/science/06dogs.html?_r=1&ex=1210737600&en=313979157c777587&ei=5070&emc=eta-1), 2008.
- [I51] S. Silberman. The Bacteria Whisperer. *Wired Magazine*. <http://www.wired.com/wired/archive/11.04/quorum.html>, April 2003.
- [I52] U. P. Vijh. Extended Red Emission. [http://ardbeg.astro.utoledo.edu/~karen/baglunch/vijh\\_abl\\_spr04.pdf](http://ardbeg.astro.utoledo.edu/~karen/baglunch/vijh_abl_spr04.pdf), 2004.

# Neuroscience and Consciousness

- [J1] Visual short term memory. [http://en.wikipedia.org/wiki/Visual\\_short-term\\_memory](http://en.wikipedia.org/wiki/Visual_short-term_memory).
- [J2] Brain. <http://en.wikipedia.org/wiki/Brain>.
- [J3] Frontal lobes. [http://en.wikipedia.org/wiki/Frontal\\_lobes](http://en.wikipedia.org/wiki/Frontal_lobes).
- [J4] Goldman equation. [http://en.wikipedia.org/wiki/Goldman\\_equation](http://en.wikipedia.org/wiki/Goldman_equation).
- [J5] Limbic system. [http://en.wikipedia.org/wiki/Limbic\\_system](http://en.wikipedia.org/wiki/Limbic_system).
- [J6] A method of changing biological object's hereditary signs and a device for biological information directed transfer. Patent N1828665. Application N3434801, invention priority as of 30.12.1981, registered 13.10.1992.
- [J7] Short term memory. [http://en.wikipedia.org/wiki/Short\\_term\\_memory](http://en.wikipedia.org/wiki/Short_term_memory).
- [J8] Biofield Research: A Roundtable Discussion of Scientific and Methodological Issues. *The journal of alternative and complementary medicine*, 18(12):1081–1086, 2012.
- [J9] D. J. Benor. *Spiritual Healing: scientific validation of a healing revolution Vol. I*. Vision publications, Southfield MI, 2001.
- [J10] D. J. Bierman and D. I. Radin. Anomalous Anticipatory Response on Randomized Future Conditions. *Perceptual and Motor Skills*, 84:689–690, 1997.
- [J11] C. F. Blackman. *Effect of Electrical and Magnetic Fields on the Nervous System*, pages 331–355. Plenum, New York, 1994.
- [J12] V. Chernobrov. Experiments on the Change of Direction and Rate of Time Motion. In *Proc. of III Int. Conf. On Problems of Space, Time, and Gravitation. Russian Academy of Sciences, St. Petersburg, Russia*, 1996.
- [J13] U. Di Corpo. The conflict between entropy and syntropy: the vital needs model. 2007.
- [J14] B. Libet et al. Subjective referral of the timing for a conscious sensory experience. *Brain*, 102, 1979.
- [J15] C. F. Blackman et al. Induction of calcium-ion efflux from brain tissue by radio-frequency radiation: effects of modulation frequency and field strength. *Radio Sci.*, 14, 1979.
- [J16] H. Abdelmeik et al. Impact of evolution on the electrical properties of sciatic nerves: superconductivity-like. *Journal of Physical & Chemical News*, 2003.

- [J17] S. W. Lazar et al. Meditation experience is associated with increased cortical thickness. *Neuroreport*, 16(17):1893–1897, 2005.
- [J18] L. Fantappie. *Teoria Unitaria del Mondo Fisico e Biologico*. Di Renzo Editore, Roma, 1942.
- [J19] M. Germine. Scientific Validation of Planetary Consciousness. *Journal of Non-Locality and Remote Mental Interactions*. <http://www.emergentmind.org/germineI3.htm>, 1(3), 2002.
- [J20] S. Klein. Libet’s Research on Timing of Conscious Intention to Act: A Commentary. *Consciousness and Cognition*. [http://cornea.berkeley.edu/pubs/ccog\\_2002\\_0580-Klein-Commentary.pdf](http://cornea.berkeley.edu/pubs/ccog_2002_0580-Klein-Commentary.pdf), 11, 2002.
- [J21] B. Libet. Readiness potentials preceding unrestricted spontaneous and preplanned voluntary acts. [http://cornea.berkeley.edu/pubs/ccog\\_2002\\_0580-Klein-Commentary.pdf](http://cornea.berkeley.edu/pubs/ccog_2002_0580-Klein-Commentary.pdf), 1982.
- [J22] J. McMoneagle. *Remote Viewing Secrets*. Hampton Roads Publishing Company, Inc., 2000.
- [J23] Kozyrev N.A. *Prichinnaya ili nesimmetrichnaya mekhanika v lineinom priblizhenii*. GAO AN SSSR, Pulkovo, 1958.
- [J24] P. L. Nunez. Toward a Quantitative Description of Large Scale Neocortical Dynamic Function and EEG. *Behavioral and Brain Sciences*, 23, 2000.
- [J25] M. Persinger. The tectonic strain theory as an explanation for UFO phenomena. <http://www.laurentian.ca/www/neurosci/tectonicedit.htm>, 1999.
- [J26] D. Reed. Conceptual Hurdles to New Millennium Physics. *Explore!*, (1), 2003.
- [J27] C. Smith. Learning From Water, A Possible Quantum Computing Medium. In *CASYS’2001, 5th international conference on Computing Anticipating Systems held in Liege, Belgium, August 13-18. Abstract book*. CHAOS, 2001.
- [J28] W. A. Tiller. Towards a Quantitative Science and Technology that Includes Human Consciousness. *Vision-In-Action*. <http://www.via-visioninaction.org>, 4, 2003.
- [J29] W. A. Tiller and W. E. Dibble Jr. New experimental data revealing an unexpected dimension to materials science and engineering. *Mat. Res. Innovat.*, 5:21–34, 2001.
- [J30] W. A. Tiller and W. E. Dibble Jr. Anomalous Temperature Oscillation Behavior Near a Source in a ”Conditioned” Space: part I, The Spatial Variation. <http://tillerfoundation.com/newpapers.htm>, 2002.
- [J31] A. Vannini. Advanced Waves, Retrocausality, and Consciousness. 2007.
- [J32] W. E. Dibble Jr. W. A. Tiller and M. J. Kohane. *Conscious Acts of Creation: the Emergence of a New Physics*, volume 17. Pavior Publishing, 2001.
- [J33] L. Day (with G. DelaWarr). *New Worlds Beyond the Atom*. Vincent Stuart Publishers Ltd., London, 1956.

## Books related to TGD

- [K1] M. Pitkänen. 1983.



- [K2] M. Pitkänen. Is it Possible to Understand Coupling Constant Evolution at Space-Time Level? In *Towards M-Matrix*. Onlinebook. [http://tgdtheory.fi/public\\_html/tgdquant/tgdquantum.html#rgflow](http://tgdtheory.fi/public_html/tgdquant/tgdquantum.html#rgflow), 2006.
- [K3] M. Pitkänen. A Model for Protein Folding and Bio-catalysis. In *Genes and Memes*. Onlinebook. [http://tgdtheory.fi/public\\_html/genememe/genememe.html#foldcat](http://tgdtheory.fi/public_html/genememe/genememe.html#foldcat), 2006.
- [K4] M. Pitkänen. About Strange Effects Related to Rotating Magnetic Systems . In *TGD and Fringe Physics*. Onlinebook. [http://tgdtheory.fi/public\\_html/freenergy/freenergy.html#Faraday](http://tgdtheory.fi/public_html/freenergy/freenergy.html#Faraday), 2006.
- [K5] M. Pitkänen. About the New Physics Behind Qualia. In *Quantum Hardware of Living Matter*. Onlinebook. [http://tgdtheory.fi/public\\_html/bioware/bioware.html#newphys](http://tgdtheory.fi/public_html/bioware/bioware.html#newphys), 2006.
- [K6] M. Pitkänen. An Overview about Quantum TGD: Part I. In *Topological Geometrodynamics: Overview*. Onlinebook. [http://tgdtheory.fi/public\\_html/tgdview/tgdview.html#evoII](http://tgdtheory.fi/public_html/tgdview/tgdview.html#evoII), 2006.
- [K7] M. Pitkänen. An Overview about the Evolution of Quantum TGD. In *Topological Geometrodynamics: Overview*. Onlinebook. [http://tgdtheory.fi/public\\_html/tgdview/tgdview.html#evoI](http://tgdtheory.fi/public_html/tgdview/tgdview.html#evoI), 2006.
- [K8] M. Pitkänen. Anomalies Related to the Classical  $Z^0$  Force and Gravitation. In *TGD and Fringe Physics*. Onlinebook. [http://tgdtheory.fi/public\\_html/freenergy/freenergy.html#Zanom](http://tgdtheory.fi/public_html/freenergy/freenergy.html#Zanom), 2006.
- [K9] M. Pitkänen. Appendix A: Quantum Groups and Related Structures. In *Hyper-finite Factors and Dark Matter Hierarchy*. Onlinebook. [http://tgdtheory.fi/public\\_html/neuplanck/neuplanck.html#bialgebra](http://tgdtheory.fi/public_html/neuplanck/neuplanck.html#bialgebra), 2006.
- [K10] M. Pitkänen. Basic Extremals of Kähler Action. In *Physics in Many-Sheeted Space-Time*. Onlinebook. [http://tgdtheory.fi/public\\_html/tgdclass/tgdclass.html#class](http://tgdtheory.fi/public_html/tgdclass/tgdclass.html#class), 2006.
- [K11] M. Pitkänen. *Bio-Systems as Conscious Holograms*. Onlinebook. [http://tgdtheory.fi/public\\_html/hologram/hologram.html](http://tgdtheory.fi/public_html/hologram/hologram.html), 2006.
- [K12] M. Pitkänen. Bio-Systems as Conscious Holograms. In *Bio-Systems as Conscious Holograms*. Onlinebook. [http://tgdtheory.fi/public\\_html/hologram/hologram.html#hologram](http://tgdtheory.fi/public_html/hologram/hologram.html#hologram), 2006.
- [K13] M. Pitkänen. *Bio-Systems as Self-Organizing Quantum Systems*. Onlinebook. [http://tgdtheory.fi/public\\_html/bioselforg/bioselforg.html](http://tgdtheory.fi/public_html/bioselforg/bioselforg.html), 2006.
- [K14] M. Pitkänen. Bio-Systems as Super-Conductors: part I. In *Quantum Hardware of Living Matter*. Onlinebook. [http://tgdtheory.fi/public\\_html/bioware/bioware.html#superc1](http://tgdtheory.fi/public_html/bioware/bioware.html#superc1), 2006.
- [K15] M. Pitkänen. Bio-Systems as Super-Conductors: part II. In *Quantum Hardware of Living Matter*. Onlinebook. [http://tgdtheory.fi/public\\_html/bioware/bioware.html#superc2](http://tgdtheory.fi/public_html/bioware/bioware.html#superc2), 2006.
- [K16] M. Pitkänen. Construction of Quantum Theory: M-matrix. In *Towards M-Matrix*. Onlinebook. [http://tgdtheory.fi/public\\_html/tgdquant/tgdquantum.html#towards](http://tgdtheory.fi/public_html/tgdquant/tgdquantum.html#towards), 2006.
- [K17] M. Pitkänen. Cosmic Strings. In *Physics in Many-Sheeted Space-Time*. Onlinebook. [http://tgdtheory.fi/public\\_html/tgdclass/tgdclass.html#cstrings](http://tgdtheory.fi/public_html/tgdclass/tgdclass.html#cstrings), 2006.
- [K18] M. Pitkänen. Could Genetic Code Be Understood Number Theoretically? In *Genes and Memes*. Onlinebook. [http://tgdtheory.fi/public\\_html/genememe/genememe.html#genenumber](http://tgdtheory.fi/public_html/genememe/genememe.html#genenumber), 2006.
- [K19] M. Pitkänen. Crop Circles and Life at Parallel Space-Time Sheets. In *Magnetospheric Consciousness*. Onlinebook. [http://tgdtheory.fi/public\\_html/magnconsc/magnconsc.html#crop1](http://tgdtheory.fi/public_html/magnconsc/magnconsc.html#crop1), 2006.

- [K20] M. Pitkänen. Crop Circles and Life at Parallel Space-Time Sheets. In *Magnetospheric Consciousness*. Onlinebook. [http://tgdtheory.fi/public\\_html/magnconsc/magnconsc.html#crop2](http://tgdtheory.fi/public_html/magnconsc/magnconsc.html#crop2), 2006.
- [K21] M. Pitkänen. Dark Forces and Living Matter. In *Hyper-finite Factors and Dark Matter Hierarchy*. Onlinebook. [http://tgdtheory.fi/public\\_html/neuplanck/neuplanck.html#darkforces](http://tgdtheory.fi/public_html/neuplanck/neuplanck.html#darkforces), 2006.
- [K22] M. Pitkänen. Dark Matter Hierarchy and Hierarchy of EEGs. In *TGD and EEG*. Onlinebook. [http://tgdtheory.fi/public\\_html/tgdeeg/tgdeeg.html#eegdark](http://tgdtheory.fi/public_html/tgdeeg/tgdeeg.html#eegdark), 2006.
- [K23] M. Pitkänen. Dark Nuclear Physics and Condensed Matter. In *Hyper-finite Factors and Dark Matter Hierarchy*. Onlinebook. [http://tgdtheory.fi/public\\_html/neuplanck/neuplanck.html#exonuclear](http://tgdtheory.fi/public_html/neuplanck/neuplanck.html#exonuclear), 2006.
- [K24] M. Pitkänen. Did Tesla Discover the Mechanism Changing the Arrow of Time? In *TGD and Fringe Physics*. Onlinebook. [http://tgdtheory.fi/public\\_html/freenergy/freenergy.html#tesla](http://tgdtheory.fi/public_html/freenergy/freenergy.html#tesla), 2006.
- [K25] M. Pitkänen. DNA as Topological Quantum Computer. In *Genes and Memes*. Onlinebook. [http://tgdtheory.fi/public\\_html/genememe/genememe.html#dnatqc](http://tgdtheory.fi/public_html/genememe/genememe.html#dnatqc), 2006.
- [K26] M. Pitkänen. Does TGD Predict the Spectrum of Planck Constants? In *Hyper-finite Factors and Dark Matter Hierarchy*. Onlinebook. [http://tgdtheory.fi/public\\_html/neuplanck/neuplanck.html#Planck](http://tgdtheory.fi/public_html/neuplanck/neuplanck.html#Planck), 2006.
- [K27] M. Pitkänen. Evolution in Many-Sheeted Space-Time. In *Genes and Memes*. Onlinebook. [http://tgdtheory.fi/public\\_html/genememe/genememe.html#prebio](http://tgdtheory.fi/public_html/genememe/genememe.html#prebio), 2006.
- [K28] M. Pitkänen. General Ideas about Many-Sheeted Space-Time: Part I. In *Physics in Many-Sheeted Space-Time*. Onlinebook. [http://tgdtheory.fi/public\\_html/tgdclass/tgdclass.html#topcond](http://tgdtheory.fi/public_html/tgdclass/tgdclass.html#topcond), 2006.
- [K29] M. Pitkänen. General Theory of Qualia. In *Bio-Systems as Conscious Holograms*. Onlinebook. [http://tgdtheory.fi/public\\_html/hologram/hologram.html#qualia](http://tgdtheory.fi/public_html/hologram/hologram.html#qualia), 2006.
- [K30] M. Pitkänen. *Genes and Memes*. Onlinebook. [http://tgdtheory.fi/public\\_html/genememe/genememe.html](http://tgdtheory.fi/public_html/genememe/genememe.html), 2006.
- [K31] M. Pitkänen. Genes and Memes. In *Genes and Memes*. Onlinebook. [http://tgdtheory.fi/public\\_html/genememe/genememe.html#genememec](http://tgdtheory.fi/public_html/genememe/genememe.html#genememec), 2006.
- [K32] M. Pitkänen. Homeopathy in Many-Sheeted Space-Time. In *Bio-Systems as Conscious Holograms*. Onlinebook. [http://tgdtheory.fi/public\\_html/hologram/hologram.html#homeoc](http://tgdtheory.fi/public_html/hologram/hologram.html#homeoc), 2006.
- [K33] M. Pitkänen. Macro-Temporal Quantum Coherence and Spin Glass Degeneracy. In *Bio-Systems as Conscious Holograms*. Onlinebook. [http://tgdtheory.fi/public\\_html/hologram/hologram.html#macro](http://tgdtheory.fi/public_html/hologram/hologram.html#macro), 2006.
- [K34] M. Pitkänen. Macroscopic Quantum Coherence and Quantum Metabolism as Different Sides of the Same Coin: Part I. In *Bio-Systems as Conscious Holograms*. Onlinebook. [http://tgdtheory.fi/public\\_html/hologram/hologram.html#metab](http://tgdtheory.fi/public_html/hologram/hologram.html#metab), 2006.
- [K35] M. Pitkänen. Macroscopic Quantum Coherence and Quantum Metabolism as Different Sides of the Same Coin: Part II. In *Bio-Systems as Conscious Holograms*. Onlinebook. [http://tgdtheory.fi/public\\_html/hologram/hologram.html#molephoto](http://tgdtheory.fi/public_html/hologram/hologram.html#molephoto), 2006.
- [K36] M. Pitkänen. Macroscopic Quantum Phenomena and  $CP_2$  Geometry. In *Physics in Many-Sheeted Space-Time*. Onlinebook. [http://tgdtheory.fi/public\\_html/tgdclass/tgdclass.html#super](http://tgdtheory.fi/public_html/tgdclass/tgdclass.html#super), 2006.

- [K37] M. Pitkänen. Magnetic Sensory Canvas Hypothesis. In *TGD and EEG*. Onlinebook. [http://tgdtheory.fi/public\\_html//tgdeeg/tgdeeg/tgdeeg.html#mec](http://tgdtheory.fi/public_html//tgdeeg/tgdeeg/tgdeeg.html#mec), 2006.
- [K38] M. Pitkänen. *Magnetospheric Consciousness*. Onlinebook. [http://tgdtheory.fi/public\\_html/magnconsc/magnconsc.html](http://tgdtheory.fi/public_html/magnconsc/magnconsc.html), 2006.
- [K39] M. Pitkänen. Magnetospheric Sensory Representations. In *Magnetospheric Consciousness*. Onlinebook. [http://tgdtheory.fi/public\\_html/magnconsc/magnconsc.html#srepres](http://tgdtheory.fi/public_html/magnconsc/magnconsc.html#srepres), 2006.
- [K40] M. Pitkänen. Many-Sheeted DNA. In *Genes and Memes*. Onlinebook. [http://tgdtheory.fi/public\\_html/genememe/genememe.html#genecodec](http://tgdtheory.fi/public_html/genememe/genememe.html#genecodec), 2006.
- [K41] M. Pitkänen. Massless states and particle massivation. In *p-Adic Length Scale Hypothesis and Dark Matter Hierarchy*. Onlinebook. [http://tgdtheory.fi/public\\_html/paddark/paddark.html#mless](http://tgdtheory.fi/public_html/paddark/paddark.html#mless), 2006.
- [K42] M. Pitkänen. *Mathematical Aspects of Consciousness Theory*. Onlinebook. [http://tgdtheory.fi/public\\_html/mathconsc/mathconsc.html](http://tgdtheory.fi/public_html/mathconsc/mathconsc.html), 2006.
- [K43] M. Pitkänen. Matter, Mind, Quantum. In *TGD Inspired Theory of Consciousness*. Onlinebook. [http://tgdtheory.fi/public\\_html/tgdconsc/tgdconsc.html#conscic](http://tgdtheory.fi/public_html/tgdconsc/tgdconsc.html#conscic), 2006.
- [K44] M. Pitkänen. Negentropy Maximization Principle. In *TGD Inspired Theory of Consciousness*. Onlinebook. [http://tgdtheory.fi/public\\_html/tgdconsc/tgdconsc.html#nmpc](http://tgdtheory.fi/public_html/tgdconsc/tgdconsc.html#nmpc), 2006.
- [K45] M. Pitkänen. Nuclear String Hypothesis. In *Hyper-finite Factors and Dark Matter Hierarchy*. Onlinebook. [http://tgdtheory.fi/public\\_html/neuplanck/neuplanck.html#nuclstring](http://tgdtheory.fi/public_html/neuplanck/neuplanck.html#nuclstring), 2006.
- [K46] M. Pitkänen. *p-Adic length Scale Hypothesis and Dark Matter Hierarchy*. Onlinebook. [http://tgdtheory.fi/public\\_html/paddark/paddark.html](http://tgdtheory.fi/public_html/paddark/paddark.html), 2006.
- [K47] M. Pitkänen. *Physics in Many-Sheeted Space-Time*. Onlinebook. [http://tgdtheory.fi/public\\_html/tgdclass/tgdclass.html](http://tgdtheory.fi/public_html/tgdclass/tgdclass.html), 2006.
- [K48] M. Pitkänen. Quantum Antenna Hypothesis. In *Quantum Hardware of Living Matter*. Onlinebook. [http://tgdtheory.fi/public\\_html/bioware/bioware.html#tubic](http://tgdtheory.fi/public_html/bioware/bioware.html#tubic), 2006.
- [K49] M. Pitkänen. Quantum Astrophysics. In *Physics in Many-Sheeted Space-Time*. Onlinebook. [http://tgdtheory.fi/public\\_html/tgdclass/tgdclass.html#gastro](http://tgdtheory.fi/public_html/tgdclass/tgdclass.html#gastro), 2006.
- [K50] M. Pitkänen. Quantum Control and Coordination in Bio-systems: Part I. In *Bio-Systems as Self-Organizing Quantum Systems*. Onlinebook. [http://tgdtheory.fi/public\\_html/bioselforg/bioselforg.html#qcococI](http://tgdtheory.fi/public_html/bioselforg/bioselforg.html#qcococI), 2006.
- [K51] M. Pitkänen. Quantum Control and Coordination in Bio-Systems: Part II. In *Bio-Systems as Self-Organizing Quantum Systems*. Onlinebook. [http://tgdtheory.fi/public\\_html/bioselforg/bioselforg.html#qcococII](http://tgdtheory.fi/public_html/bioselforg/bioselforg.html#qcococII), 2006.
- [K52] M. Pitkänen. Quantum Hall effect and Hierarchy of Planck Constants. In *Hyper-finite Factors and Dark Matter Hierarchy*. Onlinebook. [http://tgdtheory.fi/public\\_html/neuplanck/neuplanck.#anyontgd](http://tgdtheory.fi/public_html/neuplanck/neuplanck.#anyontgd), 2006.
- [K53] M. Pitkänen. *Quantum Hardware of Living Matter*. Onlinebook. [http://tgdtheory.fi/public\\_html/bioware/bioware.html](http://tgdtheory.fi/public_html/bioware/bioware.html), 2006.
- [K54] M. Pitkänen. Quantum Model for Bio-Superconductivity: I. In *TGD and EEG*. Onlinebook. [http://tgdtheory.fi/public\\_html//tgdeeg/tgdeeg/tgdeeg.html#biosupercondI](http://tgdtheory.fi/public_html//tgdeeg/tgdeeg/tgdeeg.html#biosupercondI), 2006.
- [K55] M. Pitkänen. Quantum Model for Bio-Superconductivity: II. In *TGD and EEG*. Onlinebook. [http://tgdtheory.fi/public\\_html//tgdeeg/tgdeeg/tgdeeg.html#biosupercondII](http://tgdtheory.fi/public_html//tgdeeg/tgdeeg/tgdeeg.html#biosupercondII), 2006.

- [K56] M. Pitkänen. Quantum Model for Hearing. In *TGD and EEG*. Onlinebook. [http://tgdtheory.fi/public\\_html/tgdeeg/tgdeeg/tgdeeg.html#hearing](http://tgdtheory.fi/public_html/tgdeeg/tgdeeg/tgdeeg.html#hearing), 2006.
- [K57] M. Pitkänen. Quantum Model for Nerve Pulse. In *TGD and EEG*. Onlinebook. [http://tgdtheory.fi/public\\_html/tgdeeg/tgdeeg/tgdeeg.html#pulse](http://tgdtheory.fi/public_html/tgdeeg/tgdeeg/tgdeeg.html#pulse), 2006.
- [K58] M. Pitkänen. Quantum Model for Paranormal Phenomena. In *TGD Inspired Theory of Consciousness*. Onlinebook. [http://tgdtheory.fi/public\\_html/tgdconsc/tgdconsc.html#parac](http://tgdtheory.fi/public_html/tgdconsc/tgdconsc.html#parac), 2006.
- [K59] M. Pitkänen. Quantum Model for Sensory Representations. In *TGD Inspired Theory of Consciousness*. Onlinebook. [http://tgdtheory.fi/public\\_html/tgdconsc/tgdconsc.html#expc](http://tgdtheory.fi/public_html/tgdconsc/tgdconsc.html#expc), 2006.
- [K60] M. Pitkänen. Quantum Model of EEG. In *TGD and EEG*. Onlinebook. [http://tgdtheory.fi/public\\_html/tgdeeg/tgdeeg.html#eegII](http://tgdtheory.fi/public_html/tgdeeg/tgdeeg.html#eegII), 2006.
- [K61] M. Pitkänen. Quantum Model of Memory. In *TGD Inspired Theory of Consciousness*. Onlinebook. [http://tgdtheory.fi/public\\_html/tgdconsc/tgdconsc.html#memoryc](http://tgdtheory.fi/public_html/tgdconsc/tgdconsc.html#memoryc), 2006.
- [K62] M. Pitkänen. *Quantum Physics as Infinite-Dimensional Geometry*. Onlinebook. [http://tgdtheory.fi/public\\_html/tgdgeom/tgdgeom.html](http://tgdtheory.fi/public_html/tgdgeom/tgdgeom.html), 2006.
- [K63] M. Pitkänen. Quantum Theory of Self-Organization. In *Bio-Systems as Self-Organizing Quantum Systems*. Onlinebook. [http://tgdtheory.fi/public\\_html/bioselforg/bioselforg.html#selforgac](http://tgdtheory.fi/public_html/bioselforg/bioselforg.html#selforgac), 2006.
- [K64] M. Pitkänen. Semi-trance, Mental Illness, and Altered States of Consciousness. In *Magnetospheric Consciousness*. Onlinebook. [http://tgdtheory.fi/public\\_html/magnconsc/magnconsc.html#semitrancec](http://tgdtheory.fi/public_html/magnconsc/magnconsc.html#semitrancec), 2006.
- [K65] M. Pitkänen. Semitrance, Language, and Development of Civilization. In *Magnetospheric Consciousness*. Onlinebook. [http://tgdtheory.fi/public\\_html/magnconsc/magnconsc.html#langsoc](http://tgdtheory.fi/public_html/magnconsc/magnconsc.html#langsoc), 2006.
- [K66] M. Pitkänen. Super-Conductivity in Many-Sheeted Space-Time. In *Hyper-finite Factors and Dark Matter Hierarchy*. Onlinebook. [http://tgdtheory.fi/public\\_html/neuplanck/neuplanck.html#supercond](http://tgdtheory.fi/public_html/neuplanck/neuplanck.html#supercond), 2006.
- [K67] M. Pitkänen. TGD and Astrophysics. In *Physics in Many-Sheeted Space-Time*. Onlinebook. [http://tgdtheory.fi/public\\_html/tgdclass/tgdclass.html#astro](http://tgdtheory.fi/public_html/tgdclass/tgdclass.html#astro), 2006.
- [K68] M. Pitkänen. TGD and Cosmology. In *Physics in Many-Sheeted Space-Time*. Onlinebook. [http://tgdtheory.fi/public\\_html/tgdclass/tgdclass.html#cosmo](http://tgdtheory.fi/public_html/tgdclass/tgdclass.html#cosmo), 2006.
- [K69] M. Pitkänen. *TGD and EEG*. Onlinebook. [http://tgdtheory.fi/public\\_html/tgdeeg/tgdeeg.html](http://tgdtheory.fi/public_html/tgdeeg/tgdeeg.html), 2006.
- [K70] M. Pitkänen. *TGD and Fringe Physics*. Onlinebook. [http://tgdtheory.fi/public\\_html/freenergy/freenergy.html](http://tgdtheory.fi/public_html/freenergy/freenergy.html), 2006.
- [K71] M. Pitkänen. TGD and Nuclear Physics. In *Hyper-finite Factors and Dark Matter Hierarchy*. Onlinebook. [http://tgdtheory.fi/public\\_html/neuplanck/neuplanck.html#padnucl](http://tgdtheory.fi/public_html/neuplanck/neuplanck.html#padnucl), 2006.
- [K72] M. Pitkänen. *TGD as a Generalized Number Theory*. Onlinebook. [http://tgdtheory.fi/public\\_html/tgdnumber/tgdnumber.html](http://tgdtheory.fi/public_html/tgdnumber/tgdnumber.html), 2006.
- [K73] M. Pitkänen. TGD as a Generalized Number Theory: p-Adicization Program. In *TGD as a Generalized Number Theory*. Onlinebook. [http://tgdtheory.fi/public\\_html/tgdnumber/tgdnumber.html#visiona](http://tgdtheory.fi/public_html/tgdnumber/tgdnumber.html#visiona), 2006.

- [K74] M. Pitkänen. TGD as a Generalized Number Theory: Quaternions, Octonions, and their Hyper Counterparts. In *TGD as a Generalized Number Theory*. Onlinebook. [http://tgdtheory.fi/public\\_html/tgdnumber/tgdnumber.html#visionb](http://tgdtheory.fi/public_html/tgdnumber/tgdnumber.html#visionb), 2006.
- [K75] M. Pitkänen. TGD Based Model for OBEs. In *TGD Inspired Theory of Consciousness*. Onlinebook. [http://tgdtheory.fi/public\\_html/tgdconsc/tgdconsc.html#OBE](http://tgdtheory.fi/public_html/tgdconsc/tgdconsc.html#OBE), 2006.
- [K76] M. Pitkänen. *TGD Inspired Theory of Consciousness*. Onlinebook. [http://tgdtheory.fi/public\\_html/tgdconsc/tgdconsc.html](http://tgdtheory.fi/public_html/tgdconsc/tgdconsc.html), 2006.
- [K77] M. Pitkänen. TGD Inspired Theory of Consciousness. In *Topological Geometrodynamics: Overview*. Onlinebook. [http://tgdtheory.fi/public\\_html/tgdview/tgdview.html#tgdconsc2010](http://tgdtheory.fi/public_html/tgdview/tgdview.html#tgdconsc2010), 2006.
- [K78] M. Pitkänen. The Notion of Free Energy and Many-Sheeted Space-Time Concept. In *TGD and Fringe Physics*. Onlinebook. [http://tgdtheory.fi/public\\_html/freenergy/freenergy.html#freenergy](http://tgdtheory.fi/public_html/freenergy/freenergy.html#freenergy), 2006.
- [K79] M. Pitkänen. The Recent Status of Lepto-hadron Hypothesis. In *Hyper-finite Factors and Dark Matter Hierarchy*. Onlinebook. [http://tgdtheory.fi/public\\_html/neuplanck/neuplanck.html#leptc](http://tgdtheory.fi/public_html/neuplanck/neuplanck.html#leptc), 2006.
- [K80] M. Pitkänen. The Relationship Between TGD and GRT. In *Physics in Many-Sheeted Space-Time*. Onlinebook. [http://tgdtheory.fi/public\\_html/tgdclass/tgdclass.html#tgdgrt](http://tgdtheory.fi/public_html/tgdclass/tgdclass.html#tgdgrt), 2006.
- [K81] M. Pitkänen. Three new physics realizations of the genetic code and the role of dark matter in bio-systems. In *Genes and Memes*. Onlinebook. [http://tgdtheory.fi/public\\_html/genememe/genememe.html#dnatqccodes](http://tgdtheory.fi/public_html/genememe/genememe.html#dnatqccodes), 2006.
- [K82] M. Pitkänen. Time, Spacetime and Consciousness. In *Bio-Systems as Conscious Holograms*. Onlinebook. [http://tgdtheory.fi/public\\_html/hologram/hologram.html#time](http://tgdtheory.fi/public_html/hologram/hologram.html#time), 2006.
- [K83] M. Pitkänen. *Topological Geometrodynamics: an Overview*. Onlinebook. [http://tgdtheory.fi/public\\_html/tgdview/tgdview.html](http://tgdtheory.fi/public_html/tgdview/tgdview.html), 2006.
- [K84] M. Pitkänen. Topological Quantum Computation in TGD Universe. In *Genes and Memes*. Onlinebook. [http://tgdtheory.fi/public\\_html/genememe/genememe.html#tqc](http://tgdtheory.fi/public_html/genememe/genememe.html#tqc), 2006.
- [K85] M. Pitkänen. Ufos, Aliens, and the New Physics. In *Magnetospheric Consciousness*. Onlinebook. [http://tgdtheory.fi/public\\_html/magnconsc/magnconsc.html#mantleufo](http://tgdtheory.fi/public_html/magnconsc/magnconsc.html#mantleufo), 2006.
- [K86] M. Pitkänen. Was von Neumann Right After All. In *Hyper-finite Factors and Dark Matter Hierarchy*. Onlinebook. [http://tgdtheory.fi/public\\_html/neuplanck/neuplanck.html#vNeumann](http://tgdtheory.fi/public_html/neuplanck/neuplanck.html#vNeumann), 2006.
- [K87] M. Pitkänen. Wormhole Magnetic Fields. In *Quantum Hardware of Living Matter*. Onlinebook. [http://tgdtheory.fi/public\\_html/bioware/bioware.html#wormc](http://tgdtheory.fi/public_html/bioware/bioware.html#wormc), 2006.
- [K88] M. Pitkänen. Quantum Mind and Neuroscience. In *TGD based view about living matter and remote mental interactions*. Onlinebook. [http://tgdtheory.fi/public\\_html/pdfpool/lianPN.pdf](http://tgdtheory.fi/public_html/pdfpool/lianPN.pdf), 2012.
- [K89] M. Pitkänen. *TGD Based View About Living Matter and Remote Mental Interactions*. Onlinebook. [http://tgdtheory.fi/public\\_html/tgdlian/tgdlian.html](http://tgdtheory.fi/public_html/tgdlian/tgdlian.html), 2012.
- [K90] M. Pitkänen. About Concrete Realization of Remote Metabolism. In *Bio-Systems as Conscious Holograms*. Onlinebook. [http://tgdtheory.fi/public\\_html/hologram/hologram.html#remotetesla](http://tgdtheory.fi/public_html/hologram/hologram.html#remotetesla), 2013.
- [K91] M. Pitkänen. Are dark photons behind biophotons. In *TGD based view about living matter and remote mental interactions*. Onlinebook. [http://tgdtheory.fi/public\\_html/pdfpool/biophotonslian.pdf](http://tgdtheory.fi/public_html/pdfpool/biophotonslian.pdf), 2013.

- [K92] M. Pitkänen. Comments on the recent experiments by the group of Michael Persinger. In *TGD based view about living matter and remote mental interactions*. Onlinebook. [http://tgdtheory.fi/public\\_html/pdfpool/persconsc.pdf](http://tgdtheory.fi/public_html/pdfpool/persconsc.pdf), 2013.
- [K93] M. Pitkänen. Comparison of TGD inspired theory of consciousness with some other theories of consciousness. In *TGD based view about living matter and remote mental interactions*. Onlinebook. [http://tgdtheory.fi/public\\_html/pdfpool/consccomparison.pdf](http://tgdtheory.fi/public_html/pdfpool/consccomparison.pdf), 2013.
- [K94] M. Pitkänen. *Hyper-finite Factors and Dark Matter Hierarchy*. Onlinebook. [http://tgdtheory.fi/public\\_html/neuplanck/neuplanck.html](http://tgdtheory.fi/public_html/neuplanck/neuplanck.html), 2013.
- [K95] M. Pitkänen. *p-Adic length Scale Hypothesis*. Onlinebook. [http://tgdtheory.fi/public\\_html/padphys/padphys.html](http://tgdtheory.fi/public_html/padphys/padphys.html), 2013.
- [K96] M. Pitkänen. *Quantum TGD*. Onlinebook. [http://tgdtheory.fi/public\\_html/tgdquantum/tgdquantum.html](http://tgdtheory.fi/public_html/tgdquantum/tgdquantum.html), 2013.
- [K97] M. Pitkänen. TGD and Potential Anomalies of GRT. In *Physics in Many-Sheeted Space-Time*. Onlinebook. [http://tgdtheory.fi/public\\_html/tgdclass/tgdclass.html#granomalies](http://tgdtheory.fi/public_html/tgdclass/tgdclass.html#granomalies), 2013.
- [K98] M. Pitkänen. What p-Adic Icosahedron Could Mean? And What about p-Adic Manifold? In *TGD as a Generalized Number Theory*. Onlinebook. [http://tgdtheory.fi/public\\_html/tgdnumber/tgdnumber.html#picosahedron](http://tgdtheory.fi/public_html/tgdnumber/tgdnumber.html#picosahedron), 2013.

## Articles about TGD

- [L1] M. Pitkänen. Macro-temporal quantum coherence, quantum spin glass degeneracy, and number theoretic information concept. <http://www.emergentmind.org/journal.htm>, 2003.
- [L2] M. Pitkänen. Time, Space-Time, and Consciousness. <http://www.emergentmind.org/journal.htm>, 2003.
- [L3] M. Pitkänen. Further Progress in Nuclear String Hypothesis. <http://tgdtheory.fi/articles/nuclstring.pdf>, 2007.
- [L4] M. Pitkänen. TGD based solution of Fermi paradox. <http://www.physics.helsinki.fi/~matpitka/articles/fermieng.pdf>, 2007.
- [L5] M. Pitkänen. "Applied biophysics of activated water" and the basic mechanism of water memory in TGD framework. [http://tgdtheory.fi/public\\_html/articles/activatedwater.pdf](http://tgdtheory.fi/public_html/articles/activatedwater.pdf), 2013.
- [L6] M. Pitkänen. Commentary on "Consciousness as a phenomenon in the operational architectonics of brain organization: Criticality and self-organization considerations" by Adrew A. Fingelkurts, Alexander A. Fingelkurts, and Carlos F. H. Neves. [http://tgdtheory.fi/public\\_html/articles/Fingelkurts.pdf](http://tgdtheory.fi/public_html/articles/Fingelkurts.pdf), 2013.
- [L7] M. Pitkänen. Hypnosis as Remote Mental Interaction. [http://tgdtheory.fi/public\\_html/articles/hypnosisarticle.pdf](http://tgdtheory.fi/public_html/articles/hypnosisarticle.pdf), 2013.
- [L8] M. Pitkänen. CMAP representations about TGD. <http://www.tgdtheory.fi/cmaphtml.html>, 2014.

- [L9] M. Pitkänen. CMAP representations about TGD, and TGD inspired theory of consciousness and quantum biology. <http://www.tgdtheory.fi/tgdglossary.pdf>, 2014.
- [L10] M. Pitkänen. Pollack's Findings about Fourth phase of Water: TGD View. [http://tgdtheory.fi/public\\_html/articles/PollackYoutube.pdf](http://tgdtheory.fi/public_html/articles/PollackYoutube.pdf), 2014.
- [L11] Matti Pitkänen. Basic Mechanisms associated with magnetic body.<http://www.tgdtheory.fi/webCMAPs/BasicMechanismsassociatedwithmagneticbody.html>. 2014.
- [L12] Matti Pitkänen. Bio-anomalies.<http://www.tgdtheory.fi/webCMAPs/Bio-anomalies.html>. 2014.
- [L13] Matti Pitkänen. Biophotons.<http://www.tgdtheory.fi/webCMAPs/Biophotons.html>. 2014.
- [L14] Matti Pitkänen. Cell membrane anomalies.<http://www.tgdtheory.fi/webCMAPs/Cellmembraneanomalies.html>. 2014.
- [L15] Matti Pitkänen. Classical TGD.<http://www.tgdtheory.fi/webCMAPs/ClassicalTGD.html>. 2014.
- [L16] Matti Pitkänen. Geometrization of fields.<http://www.tgdtheory.fi/webCMAPs/Geometrizationoffields.html>. 2014.
- [L17] Matti Pitkänen. Hierarchy of Planck constants.<http://www.tgdtheory.fi/webCMAPs/HierarchyofPlanckconstants.html>. 2014.
- [L18] Matti Pitkänen. Hyperfinite factors and TGD.<http://www.tgdtheory.fi/webCMAPs/HyperfinitefactorsandTGD.html>. 2014.
- [L19] Matti Pitkänen. Magnetic body.<http://www.tgdtheory.fi/webCMAPs/Magneticbody.html>. 2014.
- [L20] Matti Pitkänen. Manysheeted space-time.<http://www.tgdtheory.fi/webCMAPs/Manysheetedspace-time.html>. 2014.
- [L21] Matti Pitkänen. Pollack's observations.[http://www.tgdtheory.fi/webCMAPs/Pollack's observations.html](http://www.tgdtheory.fi/webCMAPs/Pollack's%20observations.html). 2014.
- [L22] Matti Pitkänen. Pollack's observations.[http://www.tgdtheory.fi/webCMAPs/Pollack's observations.html](http://www.tgdtheory.fi/webCMAPs/Pollack's%20observations.html). 2014.
- [L23] Matti Pitkänen. Quantum antenna hypothesis.<http://www.tgdtheory.fi/webCMAPs/Quantumantennahypothesis.html>. 2014.
- [L24] Matti Pitkänen. Quantum gravity and biology.<http://www.tgdtheory.fi/webCMAPs/Quantumgravityandbiology.html>. 2014.
- [L25] Matti Pitkänen. Quantum metabolism.<http://www.tgdtheory.fi/webCMAPs/Quantummetabolism.html>. 2014.
- [L26] Matti Pitkänen. Rotating systems and dark matter.<http://www.tgdtheory.fi/webCMAPs/Rotatingsystemsanddarkmatter.html>. 2014.
- [L27] Matti Pitkänen. Topological field quantization.<http://www.tgdtheory.fi/webCMAPs/Topologicalfieldquantization.html>. 2014.
- [L28] Matti Pitkänen. Two models for cell membrane.<http://www.tgdtheory.fi/webCMAPs/Twoamodelsforcellmembrane.html>. 2014.
- [L29] Matti Pitkänen. Water memory and homeopathy.<http://www.tgdtheory.fi/webCMAPs/Watermemoryandhomeopathy.html>. 2014.
- [L30] Matti Pitkänen. Weak form of electric-magnetic duality.<http://www.tgdtheory.fi/webCMAPs/Weakformofelectric-magneticduality.html>. 2014.

- [L31] Matti Pitkänen. Zero Energy Ontology (ZEO).[http://www.tgdtheory.fi/webCMAPs/ZeroEnergyOntology\(ZEO\).html](http://www.tgdtheory.fi/webCMAPs/ZeroEnergyOntology(ZEO).html). 2014.





# Index

- $M^4$ , 112
- $Z^0$  electric field, 25
- $Z^0$  force, 25, 50, 54, 112
- , 412
- Allais effect, 61
- ATP, 233
- binary coil, 197
- biological transmutations, 292
- Bohr quantization, 67
- Brown's gas, 281, 337
- cell membrane, 233
- cognition, 66, 233
- cold fusion, 67, 281
- conformal invariance, 65
- cosmic expansion, 67
- Coulomb wall, 282
- critical cosmology, 67
- crossing symmetry, 111
- cyclotron frequency, 232
- dark matter, 13, 23, 65, 112, 232, 282
- dark matter hierarchy, 14
- dark photon, 14
- dynamical Planck constant, 13
- electrolysis, 281, 307
- ELF em fields, 67
- evolution, 379
- extensions of p-adic numbers, 23
- extremal, 218
- Fermi paradox, 14
- field body, 65
- flow equilibrium, 113
- four-wave mechanism, 113
- free energy, 14
- geometric future, 24, 356
- geometric past, 14, 232
- geometric time, 111
- gravitational energy, 111
- gravitational flux, 111
- gravitational mass, 111
- hierarchy of Planck constants, 67
- imbedding, 107
- inertial energy, 111
- inertial mass, 111
- intentionality, 66
- Josephson frequency, 232
- Josephson junction, 233, 244
- Josephson photon, 233
- macroscopic quantum coherence, 65
- magnetic body, 14, 67, 112, 233
- magnetic motor, 281
- metabolic energy, 14, 66, 282
- metabolism, 13, 65, 111, 229
- microwave, 113
- nuclear string, 281
- p-adic physics, 66, 355
- p-adic prime, 233, 282
- p-adic time scale, 197
- parity breaking, 14, 24
- phase conjugate laser beam, 13
- phase transition, 67, 112
- photon, 113
- photosynthesis, 282
- plasmoid, 14
- quantum criticality, 114
- receptor, 65
- recycling, 66
- remote metabolism, 113, 232
- rotating magnetic systems, 121, 281
- scalar wave, 14, 197
- second law, 197
- self hierarchy, 14
- sonoluminescence, 282
- space-time sheet, 14, 24, 66, 111
- super-conductivity, 233
- Tesla, 215
- TGD inspired theory of consciousness, 14, 355
- time mirror mechanism, 114, 355
- time orientation, 24
- torque, 112
- Trojan horse mechanism, 282, 283
- UFO, 404

UFO experiences, 355

vacuum energy, 111

vacuum extremals, 111

warping, 25

zero point kinetic energy, 282